

LED
professional

www.led-professional.com

ISSN 1993-890X

Review

LpR

The leading worldwide authority for LED & OLED lighting technology information May/June 2013 | Issue

37



Heatsinks & Silicones

Electrical Protection of LEDs

Fluorescent Tube Replacement

Optical Lithography



We put the spotlight on uniformity

Philips Lumileds LUXEON CoB (Chip-on-Board) high-uniformity array solution is the breakthrough in LED efficiency that you have been waiting for. This high-voltage, high-lumen array solution gives you the best efficacy and performance all in a very compact Light Emitting Surface (LES). The LUXEON CoB gives you a bright, uniform and crisp light beam, and this industry leading small LES is extremely easy to work with, reducing your design time, production and overall costs.

The LUXEON CoB is available in a single 3-step and single 5-step MacAdam Ellipse, ensuring uniform optical performance for your application and they are hot-tested at real world operating conditions of 85°C, which means you can simplify your design and minimize testing.

When you want the best efficacy and performance for your high lumen downlights and directional bulbs, expect more from LUXEON CoB. We put the spotlight on uniformity.

www.philipslumileds.com/LUXEONCoB

PHILIPS
LUMILEDS



Quality Considerations

The life-time of LEDs depends on two types of failures that can occur: First of all, there is total destruction. This is when no light is emitted any more. The second case is when there is a reduction to a specific amount of light in relation to the lumen output at the beginning. We often see definitions such as L70B50, meaning that the amount of time for the light output of 50% of a set of LEDs will fall to 70% of their original light output under a given set of operating conditions. This is also called Lumen Maintenance according to the LM-80 definition. The "B" figure does not include total failures of LEDs. For this reason the "F" definition, or L70F10 was introduced which does include all failure-types and is therefore more precise than the "B" definition.

We know that the life-time of an LED strongly depends on the junction temperature. For example, the datasheet of a typical 350mA LED shows only 20,000 hours life-time at 110°C junction temperature. But it can increase to up to 90,000 hours at 70°C.

Therefore the design of appropriate thermal management concepts is essential for high-quality long-lasting LED systems. Depending on the power of the LED, about 50%-65% of the energy is converted into heat and has to be conducted away from the LED die. The reduction of thermal resistance is important – from the die to the substrate, on to the heat sink and finally to the air via convection. This resistance is a very critical point because it is generally high and can depend upon the mounting of the module or luminaire.

For this reason there are different active cooling concepts on the market to reduce the thermal resistance between the heat-sink and the environment. Further investigations need to be done in this area, but so far it's a trade-off between parameter improvement of the heat conductivity, additional electrical losses for the active parts, noise of active parts, system-size, life-time and costs.

Reliability, life-time and safety are inherently connected and are vital for any new technology coming on the market. In our opinion, there's not enough focus on these topics and products on the market lack in quality. For example, here in Dornbirn, we installed LEDs in all of our offices. We wanted to test numerous products and experience LED light on a day to day basis. Many products failed after a very short period of time; some after only a few days. This shows us that quality was totally underestimated by some manufacturers. We think that quality is the key topic that will influence the success of the LED/OLED lighting industry in the years to come.

Have a good read and please don't hesitate to get in touch with us and tell us what you think!

Yours Sincerely,



Siegfried Luger

Publisher, LED professional
Event Director, LpS 2013

Content

■ Editorial	p 1	COMMENTARY	p 4
Imprint	p 64	News - PRODUCTS	p 6
		News - EVENTS	p 28

■ APPLICATION			
FL Replacement LED Tubes - Challenges and Technologies	p 32		
by Arno Grabher-Meyer, LED professional			

■ INTERVIEW			
Digital Driver IC Chip Designs for Retrofit Bulbs	p 38		
by Siegfried Luger & Arno Grabher -Meyer, LED professional			

■ TECHNOLOGY			
New Optical Lithography Method for Advanced Light Extraction in LEDs	p 42		
by T. Uhrmann & H. Solak, et.al, EV Group & Eulitha AG			

■ THERMAL			
Thermal Management for LEDs Beyond Thermal Conductivity Values	p 48		
by Jade Bridges, Electrolube			
Choosing the Appropriate Heatsink for an Application	p 52		
by Jürgen Harpain, Manager of Development at Fischer Elektronik			

■ ELECTRONICS			
Protecting LEDs from Electrical Overstress Faults	p 58		
by Joe Dinkel & Spencer Guo, TE Circuit Protection			

Advertising Index

Philips Lumileds	C 1
Epistar	p 3
Bicom Optics	p 5
Cirrus Logic	p 7
CREE	p 9
LedLink	p 11
Vossloh-Schwabe	p 13
Lambda Research	p 15
Intertek	p 17
Everlight	p 18
China Int. Optoelectronic Expo	p 20
Edison	p 21
Frost & Sullivan	p 23
GSZM	p 23
Electrolube	p 25
Nuventix	p 25
Light & Sound	p 27
Infineon	p 30
Lackwerke Peters	p 30
Recom	p 31
Honglitronics	p 39
Instrument Systems	p 43
Signcomplex	p 47
GL Optic	p 49
Fischer Elektronik	p 53
LED Lighting Taiwan	p 57
euroLED	p 57
Global Lighting Technologies	p 59
Recom	p 62
Assodel/Technoimprese	p 63
LED professional / LpS	C 3
Refond	C 4



EPISTAR

Actualize LED Potential

EPISTAR Chip Inside = Quality

2013 Guangzhou International Lighting Exhibition

Date : June 9-12, 2013
Booth Number : Hall 10.2 C09

Indoor Lighting and Horticultural Lighting

www.epistar.com



Headquarters
EPISTAR Corporation
5 Li-hsin 5th Road, Hsinchu Science Park,
Hsinchu 300, Taiwan
T +886 3-567-8000 F +886 3-579-0801
sales@epistar.com.tw www.epistar.com

China Sales Office
Luxlite (Shenzhen) Corporation Limited.
21F, Sunshine Golf Building, Shennan Road,
Futian District Shenzhen 518040, China
T +86 755-3335-5666 F +86 755-3335-5777
sales168@luxlite.cn www.luxlite.cn



Website



Facebook



Nico Bruijnjs

Nico Bruijnjs holds a Bachelors Degree in Electronics Engineering and is currently the Business Development Manager for Lighting at The Bergquist Company. He has been with The Bergquist Company for approximately eight years. However, he has been an active member of the international electronics sector for nearly 20 years. The Bergquist Company is a globally recognized developer and supplier of thermal management materials for the electronics industry. They are dedicated to delivering innovative cooling solutions for the emerging lighting industry, as well as other major markets.

THE LONGEVITY OF YOUR LED DESIGN DEPENDS UPON MORE THAN JUNCTION TEMPERATURE

All the LED market forecasts are indicating strong growth for the lighting industry. As our world population increases, the need for lighting increases. However, with this demanding expansion comes the concern about global warming and rising energy prices.

Advances in lighting are transforming the lighting market from an analog to a digital world. Traditional lighting like incandescent, gas discharge and fluorescent lighting are all being challenged by the technological advances in solid state, LED, and to a lesser extent, OLED-based lighting.

There is good reason for this. Solid state lighting has many benefits over traditional lighting with the dominating advantages being low energy consumption and long lifetime. All the technical challenges have not been solved though. For example, even though LED bulbs claim a long lifetime, the life of the bulb strongly depends on the LED junction temperature. The typical rule of thumb is that a 10 degree Celsius rise in junction temperature will cut the lifetime of the LED in half, so this is clearly a critical part of the design. Also, one will need to consider whether all the other components used in the design are created in a way so that the bulb lives up to its 100,000 lifetime hours.

The internal thermal resistance of the LED has been gradually reduced over the years, which makes the thermal resistance of the substrate more visible. This is therefore driving the need for substrates with a lower thermal resistance. With FR4 substrates this can be done by adding filled vias, but the thermal resistance will stay pretty high so many decide to use a metal core printed circuit board (MCPCB) with a thermally enhanced dielectric because it provides much lower thermal resistance. This solves

the thermal challenge, but what is the long term behavior of the supplier's material? What is the long term dielectric strength of the material? Breakdown voltage is a nice number but does not predict the performance over 100,000 hours! Also, how does it perform in humid conditions?

This is true for other parts in the thermal stack-up, like a thermal interface. Has it been considered that there may be some outgassing which can fog the lens when using an interface pad or other material? The supplier should be able to provide you with the outgassing data of their materials. Bergquist is currently adding a new line of thermal fillers with low volatilities specifically to minimize the risk of lens fogging. Other technical requirements mainly come from the need to further lower costs. We anticipate fulfilling this requirement by introducing additional materials. For example, in remote phosphor designs, the reflectivity of the substrate is very important and in many cases is achieved by placing a separate reflective sheet on top of the substrate. Bergquist increases the design flexibility and reduces steps in your factory by offering a highly reflective coating which is already applied on the substrate itself.

With new materials and higher volumes, there is also going to be a drive to automate production. We are seeing a robust trend towards automatically dispensed and curable, thermally conductive liquids, which are replacing the labor intensive thermal pads.

So beyond junction temperature, it is important to consider reliability in all aspects of your design. In the years ahead, there will be a greater need for affordable, highly reliable LED systems that can push the lifecycle boundaries. ■

N.B.



LED Tube Cover

Employing the latest in injection molding technology

- Making breakthroughs in the field of LED light-emitting angles
- Our LED tube lights nearly match traditional fluorescent light distribution
- PC tubes diffuse light with 85% efficiency



LED Bulb Cover



Reflector

Bicom Optics

Bldg. B4, Xinjianxing Industrial Park, Fengxin Rd.,
Gongming, Shenzhen, Guangdong 518100, China
Tel: (86-755) 8203 3578 • Fax: (86-755) 8203 3711
E-mail: sales@bicomoptics.com
www.bicomoptics.com



Multi lenses



ProLight Introduces New HV LED Series

ProLight's High voltage (HV) LED Series are designed for applications including luminaires that have space limitations and cost sensitive lighting applications. ProLight's best performing HV LED have the efficacy of around 150 lm/W in warm white color. ProLight also provide HV Module Series, which is designed for downlight applications and cost sensitive retrofit bulbs. The module supports both 110 V and 230 V markets and have the benefit of minimizing the amount of electronic components used in drivers.



ProLight's new HV LEDs have an efficacy of about 150 lm/W in warm white color

ProLight Opto is one of the professional LED manufacturers in Taiwan and have been providing LED products for lighting application for nearly ten years. They have provided customers with its full range of lighting solutions, which includes LED emitters, LED modules, LED matching optics and drivers.

In recent years, one of ProLight's key LED products which have become more popular is its HV LEDs. ProLight's HV LED Series are designed for applications including luminaires that have space limitations and cost sensitive lighting applications. HV LED is around 15 to 20 times smaller than high-voltage LED arrays in terms of footprint, which makes it easier to integrate into the smallest LED designs. HV LED also enables driver circuits to be smaller in size, lower cost and more efficient than drivers used by standard-voltage LEDs. Currently, ProLight's best performing HV LED have the efficacy of around 150 lm/W in warm white color. ProLight also provide HV Module Series, which is designed for downlight applications and cost sensitive retrofit bulbs. The module supports both 110 V and 230 V markets and have the benefit of minimizing the amount of electronic components used in drivers, which means lower cost on drivers. The modules are factory-mounted with Pb free reflow soldering on MCPCB and can help luminaire developers to reduce both development cost and time to market. ■

Cree's Breakthrough in Light Distribution and Size - XLamp XQ

Cree, Inc. announces the availability of a new product family, XLamp® XQ LEDs, featuring a unique combination of small size, novel light distribution and high-reliability design. This combination of features enables the next generation of designs for applications that require broader light distribution such as omni-directional lamps and fixtures.



Cree's new XQ family includes two new LEDs, the XQ-B and the XQ-D

The XQ LEDs are Cree's smallest lighting-class LEDs at just 1.6 mm x 1.6 mm, 57 percent smaller than Cree's XLamp XB package. Built on Cree's revolutionary SC3 Technology™ Platform, the ceramic-based XQ LEDs are designed to deliver the long-term calculated lifetimes of Cree's other high-power LEDs, such as the high performing XP or XT LEDs. The XQ LED's new light-emission pattern directs more light towards the edge rather than the center of the package. Compared to existing LEDs, XQ LEDs allow the use of fewer packages to achieve a wide, distributed light pattern. Together, these innovations can enable manufacturers to increase the light output, expected lifetime and omni-directionality of their designs.

"The high reliability of the ceramic-based XQ-B LED allows us to offer a high-quality solution that does not compromise on lifetime," says Martin Hockemeyer, vice-chairman of the board of TELEFUNKEN Licht AG. "The unique optical advantage of the XQ-B gives us the opportunity to create the brilliant look that our customers are looking for."

"Once again, Cree is creating innovative solutions to allow our customers to differentiate their products," said Paul Thieken, Cree director of marketing, LED components. "Unlike other mid-power packages, the XQ LEDs allow lighting

manufacturers to meet their light-distribution requirements using fewer LEDs, without giving up the performance or reliability that they expect from Cree's lighting-class LEDs."

The XQ family includes two new LEDs, the XQ-B and the XQ-D. In cool white (5000 K), the XQ-B LED delivers up 160 lumens per watt at 0.18 W, and the XQ-D LED delivers up to 130 lumens-per-watt at 1 W. Both LEDs are available in 2700 K to 6500 K color temperatures with minimum 80 CRI option. ■

Samsung Launched High-Efficacy COB LED Series

Samsung Electronics Co Ltd .is introducing the new LC013/26/40B family of 13, 26 and 40 W high-efficiency, chip-on-board (COB) LED packages. Featuring a compact light-emitting surface (LES), the new family is designed for use in high-performance indoor and outdoor lighting, and in particular suits spotlight applications.



Samsung's new LC013/26/40B chip-on-board LED package

"The new COB family is designed to meet Zhaga specifications, and has a low thermal resistance and superior heat dissipation for high reliability," says Jaap Schlejen, senior vice president, LED lighting sales & marketing.

The LC013/26/40B series has a luminous efficacy of 129 lm/W at 80 CRI (color rendering index) and 5000 K CCT (correlated color temperature) and is available in 2700 K, 3000 K and 4000 K versions. By adopting chip-on-board technology that utilizes metal core PCBs, the new COB family offers what is claimed to be high color uniformity and light quality, while achieving a high luminous flux of up to 6000 lm in a single LED package. ■

Best Dimmer Performance Single-Stage LED Driver

**CS1615/16 Provides Extended Dimming
Range of Zero to 100 Percent.**

CS1615/16: New LED driver ICs drive down cost while maintaining best-in-class performance

Cirrus Logic continues to set the standard for dimmer compatibility while enabling a cost-competitive bill of material for high-volume, low-cost lamps. Through digital intelligence, the new cost-reduced single-stage CS1615/16 sets new benchmarks for flicker-free performance, extended dim range and minimum dimming – with a significant performance advantage on smart dimmers.

Like its Cirrus Logic LED driver IC predecessors, the CS1615/16 includes output open circuit protection, output short circuit protection and external over temperature protection using NTC. And a small form factor makes designs easier and enables solutions for smaller form factor lamps, including GU10. All at a total BOM cost that drives down system costs.

- Best-in-class dimmer compatibility
- Flicker-free operation across all types of dimmers
- Enables zero-100% dimming range
- Compatible with smart dimmers
- Supports isolated or non-isolated topologies
- Bill of material equivalent to single-stage competitors

Stay current at www.cirrus.com/ledprocs1615
and request a free sample.



Philips Sets New Mid-Power LED Standard with LUXEON 3535L

Philips Lumileds introduced the LUXEON 3535L family of mid-power LEDs, offering 165 lumens per watt (165 lm/W) at cool white and 150 lm/W at warm white, the highest efficacy available for the category on the market. The LUXEON 3535L line supports ENERGY STAR® certification requirements for color quality and a lumen maintenance lifetime of 35,000 hours at test conditions as high as 105°C and 150 mA.



Philips Lumiled's new LUXEON 3535L claims to have the highest efficiency in its class

Features and Benefits:

- Supports ENERGY STAR® lumen maintenance certification requirements
- High efficacy for sustainable design
- Compact 3535L package
- Full range of CCTs and minimum CRI configurations for design flexibility
- ANSI compliant 1/6th color binning

Key Applications:

- Lamps
- Indoor Area Lighting
- Downlight
- Outdoor
- Architecture
- High bay & Low bay

“Our LUXEON 3535L mid-power LED offers luminaire and lamp manufacturers unique flexibility by combining industry-leading efficacy of 165 lm/W with a wide range of CCTs and CRIs to help them achieve the right light quality for their application. The ability of the LUXEON 3535L to meet ENERGY STAR® requirements at 105°C and 150 mA puts it ahead of all competitive parts in the market,” said Khim Lee, director of mid-power products at Philips Lumileds. “With the industry’s leading lumen maintenance, the LUXEON 3535L helps luminaire and lamp manufacturers bring a quality product to market that meets the application needs of their customers.”

To provide lamp and luminaire manufacturers with maximum flexibility, LUXEON 3535L mid-power LEDs are available across a full range of CCT (2700 K – 6500 K) and CRI (70, 80 and 90) combinations. The LUXEON 3535L is already being widely used in retrofit A19 bulbs, TLEDs, and several office, indoor area lighting and retail applications. ■

Osram Expands the Duris LED Family

Duris S 5 is the latest high-tech addition to the Duris LED family from Osram Opto Semiconductors. In contrast to other components it can withstand much higher temperatures in the applications – up to 105°C. Duris S 5 is ideal for indoor lighting – in retrofits, in downlights or in panel luminaires.



The new Duris S 5 adds three brightness levels to the existing product family

The package for Duris S 5 is made from highly robust synthetic material that is resistant to aging caused by high temperatures and short-wave blue light. Compared with LEDs in other package materials, the new Duris achieves a life of more than 35,000 hours even at an ambient temperature of 105 °C. “This innovative LED package makes the component robust and cost-effective. This is then reflected of course in the luminaire manufacturing costs for our customers”, said Janick Ihringer, Product Manager Marketing SSL at Osram Opto Semiconductors.

The main applications for the new Duris are retrofits and luminaires for both linear and area indoor lighting, as used in so many places such as offices, hotel lobbies and museums. The square footprint and the small round light-emitting surface translate into a compact arrangement in the lamp. This in turn means that the light can be efficiently coupled into secondary optics such as lenses and reflectors.

Three chip surfaces – three brightness and efficacy levels:

The new Duris is being launched in three versions with different chip surfaces and therefore three different brightness levels.

The ideal application for the first version is wherever a large amount of light has to be emitted from a small surface area, for example in downlights and LED retrofits. At 3000 Kelvin (K) and a CRI of 80 it achieves very high brightness of 97 lumen (lm) and an efficacy of more than 100 lumen per watt (lm/W) at an operating current of 150 milliamps (mA). Its optimized forward voltage of around six volts (V) means that efficient driver solutions can be used that have a beneficial effect on the cost-effectiveness of the overall system.

The second version is designed for high efficacy, achieving 125 lm/W at 65 mA with 24 lm at 3000 K. It is therefore designed for use in panel luminaires and linear retrofits in which individual light points should not be visible and low energy consumption is an important consideration.

For these applications there is an alternative in the shape of version three, which has only a slightly lower efficacy and is designed for optimum system costs. It achieves an efficacy of 113 lm/W with a brightness of 28 lm – also at 3000 K. “With Duris S 5 we can offer our customers the greatest possible choice. The right LED for the particular design of luminaire can be selected, depending on whether high brightness, high efficacy or a good average of the two is required”, added Janick Ihringer. ■

Efficient Tunable CRI 90 White LED from LED Engin

LED Engin, a leader in high lumen density LED products, announces immediate availability of LuxiTune, the first intelligent, compact, single emitter light engine that delivers directional light with halogen-style dimming, hugging the black body curve from 3000 K down to 1800 K. Luminous flux is 1100 lumens, equivalent to a 60 W halogen lamp. Luminous efficacy is 63 lumens per Watt hot and including the secondary optic, far higher than that of rival products that utilize multiple emitters and reflectors.



CREE IS LED LIGHTING

innovative LED light.

As the developer of the first lighting-class LED, we're not scrambling to adapt to change; we are the change—and we won't stop until LED lighting is everywhere. That's why Cree makes the industry's best LED components for nearly every application, from directional to distributed. **Cree makes light for living.**



CREE 

Visit cree.com/innovative and learn how our full portfolio of LED components and modules can lower your system cost.

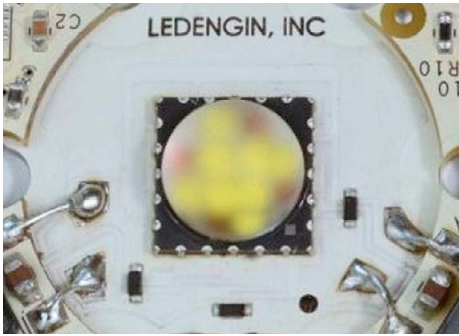

LuxiTune LED on a driver board

Features:

- Consistent halogen-style dimming: 3000 K to 1800 K along blackbody curve; within 3 SDCM throughout the dimming range
- High CRI color quality: CRI 90 at 100% intensity; CRI 85/ R9 70 throughout dimming range
- Integrated driver: sophisticated hardware and software designs offer stable CCT and flux across operating temperature range, $T_c = 15 - 85^\circ\text{C}$
- Easy and adaptable installation: support simple 0 - 10 V dimmer, DMX optional
- Lux-on-Target: smooth $24^\circ/32^\circ/45^\circ$ beam shape with minimal wasted light and glare
- Green: up to 70% less energy compared to 60 W halogen bulbs - without sacrificing color quality or tunability

At full intensity, color rendering index (CRI) is 90 and LuxiTune maintains a CRI average of 85 and R9 red content of 70 as it dims. With a diameter of 50 mm, LuxiTune makes it quick and easy to create a compact lighting fixture that works with standard 0-10 V dimmers or via a DMX interface.

The LuxiTune light engine is comprised of a 12-die, compact single emitter with intelligent control circuit and complementary TIR optic. The die are matched to within 3 MacAdam ellipses (SDCM) and dimming tracks the black body curve to within three SDCM, producing consistent, natural light across the full dimming and CCT range. The unique, multi-layer ceramic substrate minimizes the package thermal resistance and provides an almost stress-free environment for the chips providing effective heat dissipation and maximum light emission. These features ensure that color point stability is maintained throughout the product's long service life. Optics are available in 24° , 32° and 45° beam angles. The lenses facilitate uniformity over angle, maximize lumens in the beam while minimizing glare, and produce a gentle roll-off profile at the beam edges.

President and CEO of LED Engin, David Tahmassebi, comments, "Our customers in the hospitality and high-end residential sectors have been eager for an LED-based lighting solution that tunes along the black body as it dims while leveraging our strengths in lumen density and lux-on-target performance. We are excited to release LuxiTune, a professional-grade replacement for halogen downlights where dimming is required. Lighting designers who love the benefits of LED but also desire the warmer, softer tones of dimmed halogen light no longer have to compromise." ■

LUXEON Z ES: The Perfect Fit

The Micro-Mini, High-Power LED, Undomed for Precise Optical Control: Undomed for precise optical control and 75% smaller, latest LED platform from Philips Lumileds offers highest flux density: gives customers most flexibility in design and best white color consistency in industry.

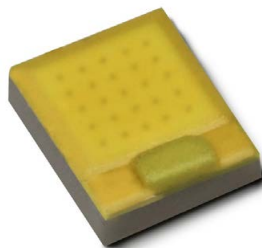

The LUXEON Z ES offers perfect color consistency within a 1-step MacAdam ellipse in warm white color options

Philips' newest high-power emitter, the LUXEON Z ES, offers industry leading color consistency through a 1-step MacAdam ellipse in warm white color options. With a micro-footprint, undomed design and full spectrum availability, LUXEON Z ES from Philips Lumileds enables high lumen density solutions with precise optical control. In applications such as retail, where superior beam angles and high efficacy are crucial, the illumination-grade emitters help lower costs while offering best in class white light.

LUXEON Z ES is available with below blackbody binning, a key feature required for superior color perception in specialty retail and hospitality applications. It also offers 10- 15 percent superior Color over Angle (CoA) over standard domed emitters for

higher Quality of Light needs in indoor applications, making it ideally suited for lamps such as GU10, BR30, and A19 lamps. In directional light sources such as an MR16 lamp, the undomed design allows better optical coupling for greater luminance at narrower beam angles and better color consistency than other LED solutions.

"The LUXEON Z ES is a clear example of our commitment to innovation with the industry's first LED platform that combines high luminance in a 1-step MacAdam Ellipse option that offers optical control in the smallest available footprint," said Raj Malhotra, Product Line Manager of the LUXEON Z family. "The micro-footprint of LUXEON Z ES means that manufacturers can use optical solutions that are 25% smaller, yet offer the same light quality that larger, domed solutions can achieve. The LUXEON Z ES will give lighting designers incredible flexibility, reduce costs and become the foundation for light sources of the future."

The LUXEON Z and Z ES emitters are offered over a range of CCTs from 2700 K to 6500 K with 5-, 3- and a first-ever 1-step MacAdam Ellipse binning option—enabling next generation of high efficiency tunable solutions with a combination of different colors, including white CCTs, lime, blue, PC amber and red. In outdoor applications, where beam angle and high efficacy are key, LUXEON Z ES also shines. ■

Cree Expanded CXA Family to Provide Higher Luminous Flux

Cree, Inc. extends the XLamp® CXA family of integrated LED arrays with the new higher-light-output CXA2540 and CXA3050 LEDs. Optimized to simplify designs and lower system cost, the new CXA LEDs deliver 5,000 to over 10,000 lumens, enabling new applications such as high-output track lights and downlights, outdoor area lighting and high-bay lighting.

The new Cree® CXA3050 LED is now the brightest member of the CXA family and can enable LED replacements for up to 100 watt ceramic metal halide in spot lighting or up to 175 watt pulse-start metal halide in high-bay and outdoor area lighting. The addition of the CXA3050 LED Array also enables lighting

NEW PRODUCT LENS



LL01CR-ADPxxL06
D x H (mm) 75.8x35
FWHM 15° 24° 38°
For Cree MTG2 / MKR
Luxeon S/M



LL01NI-ANExxL-M2
D x H (mm) 19.4x14.90
FWHM 10° 20° 30°
For Cree XPE



LL01CT-AMYxxL06
D x H (mm) 75.8x23
FWHM 24° 38°
For CITIZEN CLL030

Single lens

LL01CT-AOFxxL06
D x H (mm) 74.4x13
FWHM 24° 38°
For Citizen 020
CREE CXA1512



LL01ZZ-AHZxxL02
D x H (mm) 22.2x10.3
FWHM 24° 38°
For Cree XML EZW



LL01CR-ANWxxL06
D x H (mm) 45x26.3
FWHM 20°
For CREE MCE Colour /
XML Color /
Edison Federal
5050 RGBW



TUNNEL
LL01CR-DL70130L02
L26 / W12.8 / H 8.65
FWHM 70° x130°
For Cree XPE



TUNNEL
LL01CR-DL90120L02
L26 / W15.8 / H 9.15
FWHM 90° x 120°
For Cree XPE



LL01CR-APM80150L02
L18 / W12.5 / H 6.95
FWHM 80° x150°
For Cree XTE
-Asymmetrical

Street light lens

LL01CR-XW70140L02
L32 / W17.6 / H9.8
FWHM 70° x 140°
For Cree XM-L
Luxeon M
-Symmetrical



LL01LU-AGV80150L02
L32 / W18.5 / H9.5
FWHM 80° x 150°
For Cree XM-L / MKR
Luxeon M
-Asymmetrical



manufacturers to rapidly expand their product portfolio with higher-lumen products. The new CX2540 LED delivers up to 20 percent higher efficacy at 5,000 lumens and 3000 K than competing LED arrays of similar size. In addition, the CXA2540 shares the same mechanical package as the existing CXA2520 and CXA2530 LEDs, giving manufacturers access to the same connector and optics solutions available today.



With its updated and extended CXA family, Cree is now able to provide array LEDs with a luminous flux up to 10,000 lm

“We really like the ease-of-use and high performance of the CXA family, and we’re looking for higher-lumen versions to address the high-bay lighting market,” said Jong Hyun Woo, chief project manager, ILSUNG Ltd. “The CXA3050 LED Array gives us the performance that we need together with the high reliability that Cree is known for to create compelling designs for our customers.”

The CXA2540 and CXA3050 LED Arrays use the same proven package technology as the CXA1507 LED, which now has 6,000 hours of LM-80 data published and is able to support TM-21 calculated lifetimes of greater than 130,000 hours at binning current and greater than 85,000 hours at maximum current. This long-term calculated lifetime exceeds many other LED Arrays and plastic mid-power LEDs used today.

“Cree is the only LED manufacturer that can deliver industry-leading performance and reliability in all types of LED packages,” said Paul Thieken, Cree director of marketing, LED components. “The CXA family of integrated arrays enables lighting manufacturers with an easy-to-use, single-LED solution without compromising light output, efficacy or long-term reliability.”

To help lighting manufacturers get started designing with the new CXA integrated LED arrays, Cree has also published three

CXA-based LED reference designs: PAR30 replacement lamp, six-inch downlight and retail track light. In addition, the new CXA LEDs are available in EasyWhite® color temperatures, providing the LED industry’s best color consistency for designs that use only one LED. ■

Everlight Expands 5630 Mid-Power LED Portfolio for Light Bar and Bulb Retrofits

Everlight Electronics, a leading player in the global LED industry with three decades of experience in optoelectronics, introduces the ultra-thin 5630D mid power LED series (part number 62-217D) especially suited for LED light bars, standard and omni-directional LED light bulbs and LED high power bulbs.



Everlight’s 5630 mid power LED offers excellent cost-to-performance ratio due to high package manufacturing capacity

Everlight’s 62-217D is a standard 5630 package in a 0.5W (150mA) version for 40/60W bulb retrofits and a 0.2W (60mA) version that is suited for light bars. Both white top-view LEDs are compact and ultra-thin (5.6*3.0*0.65 mm LxWxH) and available across a complete ANSI CCT range of 2700 K (warm white) to 6500 K (cool white). These mid-power LEDs offer a CRI of min. 80 Ra and a lumens output of 50 lm (WW) and 55 lm (CW). The cool white 0.5 W version is offered up to 9000 K CCT and achieves an efficiency of 115 lm/W at 5700 K.

The lighting industry is highly dependent on high cost versus performance packages with excellent performance, stable reliability, and dependable lead times. Everlight transferred its decades of production expertise and cost competitiveness in SMD LED manufacturing for consumer handheld products to its low to

mid power Lighting LED products and developed the 62-217D (5630D) package - now a champion of all these characteristics mentioned above.

Everlight’s 62-217D (5630D) LED has a capacity of more than 200 million pieces per month. This high capacity and throughput allow for strong cost competitiveness, consistent availability and short lead times. The 62-217D (5630D) series is Pb-free, RoHS compliant, matches ANSI binning and is currently undergoing LM80 testing to demonstrate its stable lumen maintenance (already tested successfully to 3,000 hours). ■

Plessey Releases GaN on Silicon LEDs

Plessey announced that samples of its Gallium Nitride (GaN) on silicon LED products (p/n PLW111010) are available. These entry level products are the first LEDs manufactured on 6-inch GaN on silicon substrates to be commercially available anywhere in the world. Plessey is using its proprietary large diameter GaN on silicon process technology to manufacture the LEDs on its 6-inch MAGIC™ (Manufactured on GaN I/C) line at its Plymouth, England facility. The use of Plessey’s MAGIC GaN line using standard semiconductor manufacturing processing provides yield entitlements of greater than 95% and fast processing times providing a significant cost advantage over sapphire and silicon carbide based solutions for LEDs of similar quality.



Plessey Semiconductors’ new MAGICGaN on Silicon LED product

The release of the availability of Plessey’s GaN on silicon LEDs was coincident with a visit to the Plessey Plymouth facility by the Rt. Hon. Dr. Vince Cable, MP, Secretary of State for Business Innovation and Skills and President of the Board of Trade. Business Secretary

Vince Cable commented, "The government is supporting innovative companies like Plessey who are growing, creating jobs and exporting their products all over the world. That's why we selected Plessey's £3.25 million Regional Growth Fund bid for Government support, which will create 100 new, high tech and highly skilled jobs in the region."

Michael LeGoff, CEO Plessey said, "We are very pleased to welcome Secretary of State Vince Cable today. The department of Business Innovation and Skills has been very supportive of our efforts to date and with the launch of our first range of LEDs today we are now looking towards aggressive growth in the solid state lighting markets."

"Today is a significant step for us", said Barry Dennington, Plessey's COO. "From acquiring our first MOCVD reactor in August 2012 to having our first product in April 2013 is excellent progress. These entry level products will be used in indicating and accent lighting applications. We will continue to make progress in output efficiency and are on plan to release further improvements in light output throughout this year and into next. The operating and unit costs are on plan and we are seeing a number of routes to enhance our cost advantage over competing technologies."

LEDs and the associated solid state lighting solutions are due to become the dominant form of lighting in all forms in within the next five years. Solid state lighting is an energy efficient eco-friendly technology that will save billions of tons of carbon emissions when fully implemented. There are also no recycling issues that fluorescent lighting poses with mercury content. ■

Osram Ostar Stage LED: Flexible White for the Stage

Ostar Stage LEDs from Osram Opto Semiconductors offer high luminance of 48 million candelas per square meter (Mcd/m²) and tunable color tones from cold white to warm white. Combined with their extremely low-profile design and glass cover with its anti-reflective coating, they provide the basis for compact spotlights with an extremely narrow beam.

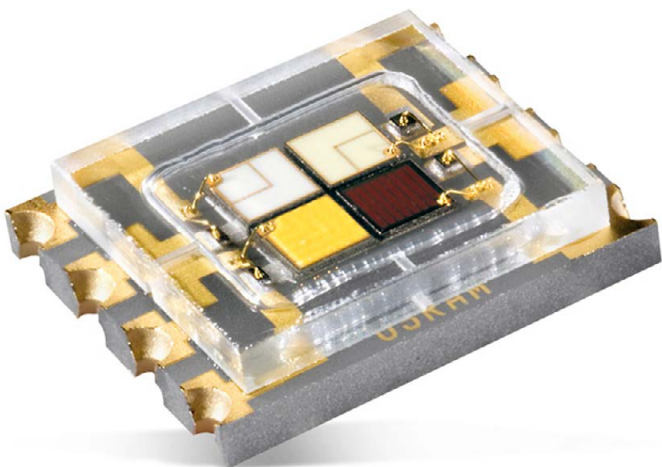

With its compact dimensions, very high luminance and color tunability, the Ostar Stage LE CWUW S2W LEDs are the perfect choice for applications like moving heads and architectural fixtures

VSS VOSSLOH SCHWABE

Your new colleague
at the office!

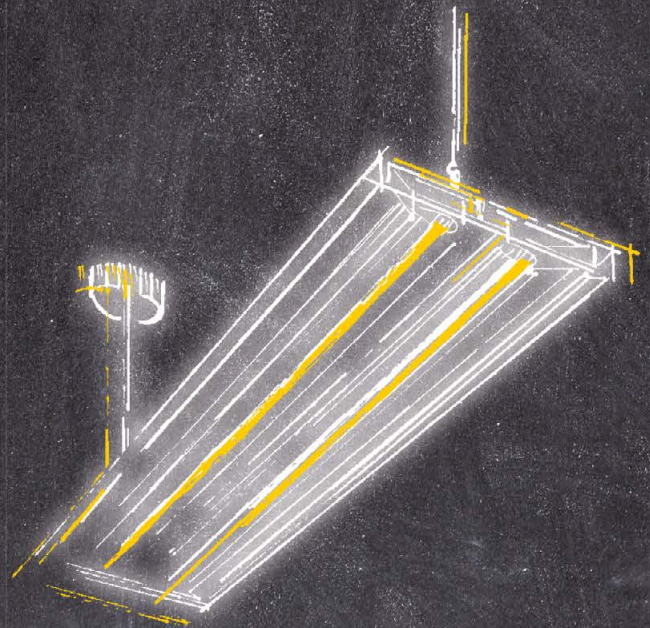

LUGA Line HO

High Output LED Modules (COB) for Linear Lighting

- Long service lifetime 50,000 h (L90, B10)
- Narrow colour tolerance: 3 McAdams
- Highly efficient: 124 lm/W at $t_c = 65^\circ\text{C}$
- Very low thermal resistance: Ceramic PCB

www.vossloh-schwabe.com

A member of the Panasonic group **Panasonic**

The special feature of the new LED is its tunable white light color. Two warm-white and two cold-white chips, arranged diagonally in the package, not only enable colors to be mixed perfectly at component level but also allow all white tones between color temperatures of 2,700 Kelvin (K) (warm white) and 10,000 K (cold white) to be produced with appropriate control. The LED achieves a high color rendering index of 94 for warm white and 74 for cold white.

Instead of the usual lens, the LEDs have a flat glass cover with an anti-reflective coating, making them ideal for injecting the light into lens systems. Its etendue (the emission angle/area ratio of the emitting light surface to the projected light surface) in conjunction with external optics is retained, enabling a very narrow beam of light (+/- 9°) to be produced. This beam is smaller by factor 2 than for spotlights based on plastic-encapsulated LEDs. Consequently, the luminance of the spotlight is greater by factor 2.

Thanks to the glass cover the Osram Ostar Stage LED also has a much lower profile than previous standard components. At 1.23 mm its height is only one quarter of the usual component height and its footprint is only 5.9 mm x 4.8 mm. Spotlights can therefore be made very compact.

All the versions of the Osram Ostar Stage are based on the successful Osram Ostar SMT platform and are suitable for standard solder processes. The chips are fabricated in state-of-the-art thin-film technology so that almost all the light produced internally is emitted at the top. The LED is therefore ideal for use with external optics. In continuous operation (DC) the chips can handle an operating current of up to 900 mA. This gives maximum values of 390 lumen (lm) in cold white (10,000 K) and 210 lm in warm white (2700 K). At a typical value of 1.8 K/W the thermal resistance is very low and heat removal is therefore no problem at all. In constant use the LEDs will last for more than 50,000 hours, giving the moving heads and architectural fixtures a very long life.

Three versions of the Osram Ostar Stage LED are available, the Multi Color (RGBW), the pure white and now the tunable white. The range of applications is therefore now greater than ever before. With so many colors and configurations lamp designers have a virtually unlimited set of options. ■

Verbatim Further Enhances Pioneering OLED Modules

Verbatim has launched the latest series of VELVE™, the world's most advanced colour-tunable and dimmable OLED modules that delivers glare-free brightness of up to 2,000 cd/m² – twice as bright as before. The new product also achieves a high luminous efficacy of 51.6 lm/W which equates to 70% greater efficiency than before.



Verbatim OLEDs are still used in very diverging applications, for example, here in the Kaiteki Cafe in Japan

At the forefront of OLED technology, Verbatim's symmetrical VELVE modules are lightweight at just 193 g while boasting a lighting area measuring 123 mm² which is bigger than the industry-standard size. The modules are thin at 8.7 mm, the width including a Process Control Block on the rear of each panel.

Verbatim's VELVE™ modules are used to create ambient and atmospheric lighting in everyday architectural applications for either decorative or functional use. Users benefit from harmonious soft-light output, integrated calibration and an even distribution of light from panel-to-panel without hot spots, glare or uncomfortable intensity. VELVE™ is particularly suitable for use in retail and hospitality locations as well as bar, restaurant and disco venues.

Many rival OLED modules available in the market are limited because they only produce white light illumination. However, VELVE™ is color-tunable and offers adjustable color creation and brightness to deliver more creative possibilities. In terms of white light, the modules now use a red, yellow and blue (RYB) system to form brighter and more accurate color mixing than was the case previously with its red, green, and blue (RGB) system.

OLED is a highly-adaptable surface light source that distributes light evenly across its complete surface area which explains why it is suited to creating a sense of mood or to gently illuminate objects. The technology removes the design boundaries usually associated with conventional lighting. There is no flickering, no glare and no excessive heat emission.

Verbatim's business development manager, Jeanine Chrobak-Kando, commented: "Verbatim is a name that is very trusted within the lighting industry for excellent quality standards and performance. By harnessing the expertise of Mitsubishi Chemical Holdings Group, VELVE™ OLED modules are designed with reliability and quality in mind to give uniform and soft lighting wherever it is needed."

"With OLED, the rulebook on architectural lighting design has been re-written. It offers tremendous creative freedom to architects and lighting designers. Ambient lighting can become an essential part of an architectural space or a specific object and light itself can be used to define furniture such as tables, chairs and shelving or the aspects of a room including walls, windows, and ceilings." ■

Round 8 inch LED Light Module for OEM Fixtures

Heatron LED Solutions, a leader in LED lighting innovations, introduces Ascendia – a high brightness 8" round LED module developed to meet the needs of luminaire manufacturers and speed time to market.



Heatron's Ascendia 8 inch LED module provides up to more than 7,000 lm

Delivering up to 7,400 lumens from an 8" diameter module, Ascendia offers luminaire manufacturers a low profile module which easily integrates into cans, cylinders, pendants and surface mount down light fixtures. Designed for mounting heights up to 30 feet, Ascendia works well in many types of lighting applications, ranging from atriums to corridors, auditoriums to sanctuaries.

Versatile and configurable, Ascendia's 3.5" low profile form factor is available with a choice of cool, neutral or warm white color temperatures with a minimum of 80 CRI. Luminaire manufacturers will find the UL 8750 approved module easy to integrate with a choice of side or top wire egress and multiple mounting configurations. Engineered for precise thermal and optical performance, Ascendia is available in 20°, 43°, and 70° beam angles and delivers uniform consistent illumination without glare for high ceiling mount applications.

Using multiple LEDs coupled to a passive cooling system Ascendia has been thermally and optically optimized and is backed by Heatron's 5-year warranty.

Ascendia provides a maintenance-free Solid State Lighting alternative to metal halide, quartz and HID sources.

"Heatron's Ascendia 8" High Brightness LED Module is an important addition to our growing portfolio of down lighting products designed specifically for integration into luminaire fixtures," said Mr. Turner, Heatron's President. "Ascendia will reduce fixture manufacturers' development costs, speed their time to market and help them capitalize on the rapidly growing commercial LED down lighting market," Turner added. ■

HSMtec PCBs Enables Smart Zhaga Multicolor Module

Cogilux' new Zhaga Book3 compliant multicolor lighting module "cogiCORE Z3-RGBW36" with up to 36 W light output makes use of Haeusemann's HSMtec boards and offers consistent color rendering thanks to an integrated color sensor.

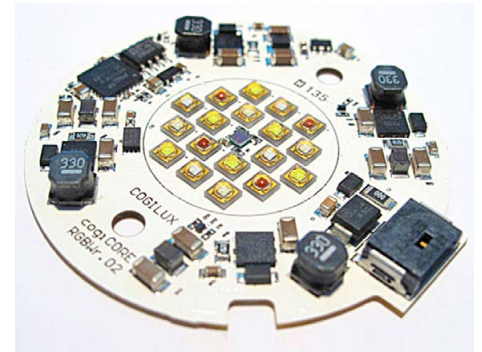

Cogilux relies on Häusermann's HSMtec boards for its Zhaga Book3 compliant multicolor lighting module

Fields of application:

- Accent lighting in showrooms
- Display case lighting
- Showcase lighting in museums, exhibitions and retail areas
- Colorful effect lighting
- Food and non food shop lighting

Benefits:

- Colored LED module solution
- Mechanically compliant to Zhaga's Book3
- Efficient thermal solutions implements LED and controlling electronics on a single FR4 PCB board

TracePro - The Most Productive LED Illumination Design Software

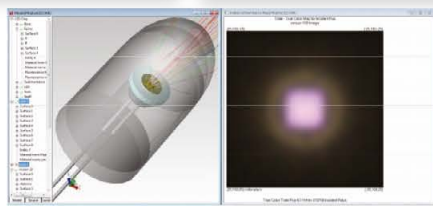
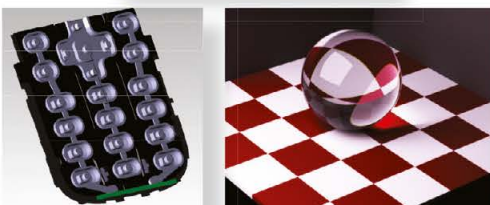
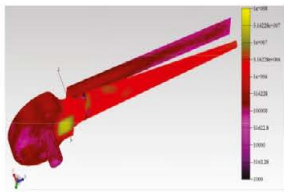

Create Optimal Systems Faster Using TracePro's Newest Design Tools!

- ▶ **Lit Appearance** – Verify the lit appearance of your design from any eye and target position with TracePro's rendering algorithms
- ▶ **3D Irradiance/Illuminance Maps** – Visually check light propagation on every part and surface for power, CIE, or true color before manufacture
- ▶ **3D Interactive Optimizer** – Use the new built-in sketch utility to create any type of CAD geometry, raytrace interactively to create the best initial design, digitize in target criteria, and control every step of the interactive optimization process



Try TracePro free for 30 days
www.lambdares.com/trials

Planning gentle accent lighting for showrooms can be very sophisticated. Lighting must take into account the specific requirements and properties of the goods and direct the customer's full attention onto the products. LED technology has recently become a factor in retail lighting, thanks to its impressively low power consumption and its extremely long service life.

Cogilux has developed a unique solution which not only provides a tuneable white light but also allows the use of RGB LEDs. So far, bulky stage lighting systems are used to realize accent lighting with RGB LEDs. Those are not only complicated to install but also misfits in a showroom. The microcontroller-based Zhaga Book 3-compliant lighting module "cogiCORE Z3-RGBW36" uses 18 red, green, blue and white OSRAM Oslon SSL LEDs reflecting the complete color spectrum with a total light output of about 36 W. Additionally, the module offers consistent color rendering due to an integrated color sensor. An integrated 32 Bit microcontroller is able to adjust and to stabilize the customer-specific light color. The customer has the choice between the cost-effective Cogilux "cogiDIM" bus system and a DMX512 interface.

The solution is mechanically compliant to the Book 3 of Zhaga interface specifications for LED light engines. The original Book 3 addresses a spot LED Light Engine with separate electronic control gear. Since the specification allows only for round LED modules with $\varnothing 50$ mm - equivalent to a space floor of about 20 cm^2 - there isn't much space left for an efficient thermal management solution.

This is where HSMtec demonstrates its advantages: The PCB solution of Häusermann makes it possible to implement LEDs and the controlling electronics on a single board. The use of sophisticated PCBs based on FR4 and copper with partially embedded copper elements allows for powerful thermal management as well as a simple way of combining complex control electronics with sensors on the LED board. HSMtec makes it possible to realize the fine structures required for the control electronic simply on the same layer as the copper elements without any additional design tools. Additionally, preliminary thermal stress tests conducted by Osram Opto Semiconductor confirmed the high reliability of Häusermann's HSMtec boards based on copper and FR4. ■

LEDiL Introduces Family of Reflectors for Zhaga-Compliant Connectors

Meet Angela and her little sister Angelina - two new families of reflectors for Zhaga-compliant solderless connectors. Optimized for performance they provide comprehensive support for the widest range of COB's from more than ten manufacturers including Bridgelux, Citizen, Cree, Nichia, Osram, Philips Lumileds and Sharp.



LEDiL's new Angela and Angelina reflectors are available for different Zhaga compliant connectors

In developing the new 120 mm diameter Angela, special attention was given to performance. This can be seen in the spot version that is optimized to provide a well defined beam pattern and highest possible center beam candle power (CBCP). The smaller 85 mm diameter Angelina provides beam characteristics typical for downlights and general lighting.

Angela and Angelina families represent the finest example of LEDiL's system reflectors philosophy - one design, endless possibilities.

Both reflector families have two variants, one with mechanical interface compatible with connectors from TE Connectivity and LEDiL clamps for Luxeon Sxxxx series COB's. Other version indicated with a -B in the product code is compatible with BJB's connectors.

Both reflector families belong to LEDiL's line of interchangeable connectors. Common mechanical interface with largest of the connector manufacturers streamlines R&D and allows faster product to market cycles. LEDiL is working actively in collaboration with companies providing connectivity and thermal managing solutions to bring benefits of the full ecosystem to the customers. ■

LYRA Optical Diffusers for COB LEDs from Khatod

The newest LYRA Optical Diffusers for COB LEDs from Khatod provide a wide selection of light diffusers performing a uniform soft light. The light coming from the LED source is diffused with a perfect Lambertian reflectance: brightness and flux are thoroughly uniform.



LYRA Optical Diffusers are in compliance with standards and fit most of the applications where COB LEDs are required

Features and Typical Applications:

- Made of PC, specific for HB COB LEDs
- High diffusion flux
- High luminous intensity
- Perfect uniform light distribution
- Easy fixing onto the COB LEDs by a simple twist & lock system
- No vibration problems
- UV protected
- Any application in General Lighting, Indoor and Outdoor: step-marker, signaling, lamps, architectural lighting, any applications where a diffused soft lighting is requested
- Complying with Zhaga standards
- Complying with UL94 Specifications
- Available in various shapes and various finishings

LYRA Optical Diffusers are provided with special adaptors, customized for the individual models of the major HB COB LEDs. The adaptors allow for the interchangeability of the LYRA Diffuser models on the same LED source.

The assembly method is unique and easy to use. No soldering or gluing is required. They allow immediate easy assembling of the diffuser onto the COB LED by a simple twist & lock system. The concept is very simple: a) fasten the adaptor onto the PCB with two screws; b) twist & lock the diffuser onto the adaptor by a simple rotation. ■

The Intertek logo is a blue rounded rectangle with the word "Intertek" in white sans-serif font.

Valued Quality. Delivered.

A large green hedge maze is shown from an elevated perspective. A bright sunburst of light emanates from the top center, illuminating a path that has been cleared through the maze. Several people in red and white safety vests are seen navigating the maze. The sky is filled with golden, dramatic clouds.

Let Intertek clear a path™ for your next innovation

**Get to market with
greater speed and simplicity.**

Before your next bright idea can enter markets around the world, you've got a choice to make. Will testing and certification be convoluted, costly and time-consuming? Or will it be painless and efficient?

Every year, thousands of manufacturers partner with Intertek to ensure their innovations are successful. From safety and performance to energy efficiency and more, we offer the most comprehensive array of testing, inspection and certification services. Our ETL Mark is the fastest-growing safety certification in North America because we're committed to exceptional service, quality and fast turnaround. And our global network of laboratories provides local expertise and project management.



Visit www.intertek.com/lighting or call 800-WORLDFAB today to learn how we remove the barriers and get you to market faster.

**45-21S Series (3020)**

- Package: 0.2W PLCC-3
- Efficacy: >113lm/W (3000K CCT)
- CRI: >80
- Thermal Resistance: 50°C/W

**62-217D Series (5630)**

- Package : 0.5W PLCC-2
- Efficacy : >93lm/W (3000K CCT)
- CRI : >80
- Thermal Resistance : 22°C/W

**XI3535 Series (3535)**

- Package : 1.0W EMC
- Efficacy : >105lm/W (3000K CCT)
- CRI : >80
- Thermal Resistance : 20°C/W

Structures and materials depend on demand of client.

Enhanced HV9910C for Simple, Cost-Effective Solution

Supertex introduced HV9910C, an open loop, current mode, universal high brightness LED driver IC. It is ideal for general and decorative LED lighting, and other DC/DC or AC/DC input based applications.

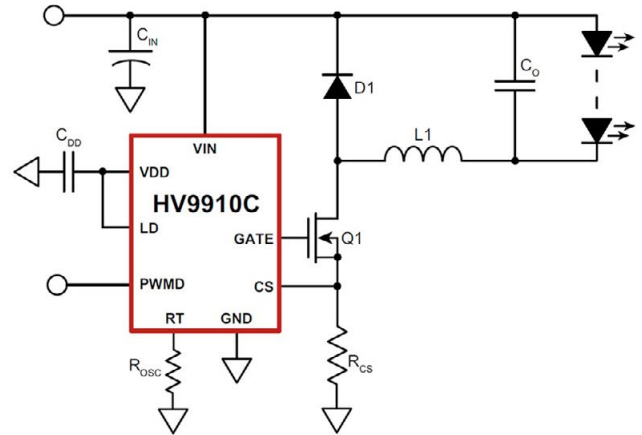

Simplified application circuit schematics for the new HV9910C LED driver

HV9910C is an enhanced drop-in replacement to the HV9910B, designed to convert high voltage supplies (85 V – 265 VAC rectified) or (15 V – 450 VDC) to a constant current source for powering a string or a combination of strings of high brightness LEDs. It can be programmed to operate in either a constant frequency or constant off-time mode and includes a 15 – 450 V linear regulator which allows it to work from a wide range of input voltages without the need for an external low voltage supply.

Features:

- Switch mode controller for single switch LED drivers
- Enhanced drop-in replacement to the HV9910B
- Open loop peak current controller
- Internal 15 to 450 V linear regulator
- Constant frequency or constant off-time operation
- Linear and PWM dimming capability
- Requires few external components for operation
- Over-temperature protection

Applications:

- DC/DC or AC/DC LED driver applications
- RGB backlighting LED driver
- Back lighting of flat panel displays
- General purpose constant current source
- Signage and decorative LED lighting
- Chargers

“HV9910C requires only three external components (apart from the power stage) to produce a controlled LED current making it an ideal solution for low system cost”, states Alex Mednik, Application Engineering Director at Supertex. “Furthermore, the low component count allows for higher reliability and minimum board space.”

HV9910C is available in a lead (Pb)-free/RoHS compliant 8L SOICN and 16L SOICN package. Samples are available from stock. Lead-time for production quantities is 4-6 weeks. ■

The Right LED for The Right Application

EVERLIGHT 3020S 0.2W, 5630D 0.5W and XI3535 1.0W LEDs are your new choices for indoor lighting applications. They offer highly competitive cost versus performance, new lead frame technology, and LM80 testing to match all your needs with different package sizes and power consumptions. EVERLIGHT offers a total solution to fulfill all demands with “The Right LED for the Right Application”.

For more information, please visit:
www.everlight.com



EVERLIGHT

Xenerqi - "Skinny" 75W LED Drivers

Xenerqi Limited introduces its newest member of the Skinny Series, the XEL-A075A, a 26 mm high, universal input driver with wide operating temperature range and 0-10 V (2-Wire) Dimming.



Slim and compact dimensions are the obvious strengths of Xenerqi's XEL-A075A Series

The XEL-A075A Series has been designed to meet the strictest requirements of the Ambient lighting space and has been put into an industry standard T8 style metal case familiar to installers and which allows for easier retrofit implementations.

This family's wide input voltage range and high efficiency make it an ideal candidate for applications requiring Energy Star or DLC Certification. The XEL-A075A family has both Constant Current and Constant Voltage variants, which can drive output currents in the 1.25 - 3.25 A range and output voltage ranges from 15 - 54 V. Thanks to Xenerqi's "Custom Made Simple" program, customized variants with specific output currents or voltages can be created within a week.

This Xenerqi 60 W ~ 75 W series has undergone extensive compliance and certification testing and are cUL 8750, CE, UL Dry/Damp Rated, FCC Part15/18 Class B compliant, meet Class A noise rating, meet Energy Star guidelines, abide by ROHS, and have a 5 year warranty. ■

MechaTronix - ModuLED Modular Passive LED Cooling

For recessed spot and down lights, you still have to sell it first, and at that point the look and feel of a product makes the first impressions. And that's exactly what the ModuLED modular passive LED coolers are designed for.

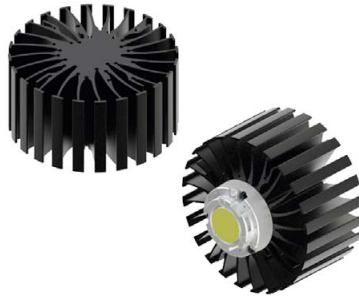

MechaTronix's ModuLED coolers offer good passive cooling performance for array LEDs and LED modules from 1,200 to 4,000 lm

ModuLED coolers offer an high end aesthetic look, combined with a perfect thermal performance and a modularity in mechanical design what allows you to easily mount different LED engines on the same LED cooler and add up secondary optics or mounting options.

From point of view of modularity on LED engines all Zhaga book 3 compatible modules as well as some specific modules LED engines can be mounted with standard self tapping screws M3x6mm.

With the Zhaga book 3 mounting availability also specific LED COB's like the Sharp Mega Zenigata, Citizen CLL030 and Edison Opto Edipower II HM can be easily mounted in combination with the Zhaga LED holders from BJB or TE Connectivity, what immediately gives you click and forget mounting availability for a wide range of reflectors.

Performance wise the ModuLED LED coolers are ideal for luminaires from 1,200 lumen to 4,000 lumen ($R_{th} 1.02^{\circ}\text{C}/\text{W}$) and are thermally verified for the MechaTronix eco partners Bridgelux, Citizen, Edison Opto, Lustrous, Philips Lumileds, Prolight Opto, Tridonic, Vossloh Schwabe and Xicato. ■

Nuventix Introduces Thermal Solution for High Bay

Cool up to 20,000 lumens with Nuventix' new R150-170! Utilizing SynJet technology this new LED Cooler is 33% smaller and 60% lighter than any passive solution while managing to side step the typical pitfalls that go with active solutions such as reliability and noise. This new product in an ever expanding portfolio of ideal thermal management solutions promises to lower overall costs while offering a better overall product.



SynJet R150-170 drastically increases cost-savings for high bay LED lighting and enables easier design and installation

"Our customers wanted more lumens from a smaller design for high bay applications and we delivered – companies simply can't cool 20,000 lumens in a 6-inch diameter design without our new SynJet cooler," said Jim Balthazar, CEO and president of Nuventix.

The modular solution can be used independently as a stand-alone heatsink or with up to three SynJets, enabling flexibility in design and cooling and allowing for an entire line of low bay and high bay luminaires with the same form factor. Due to its heat pipes and the SynJet air transfer, the R150-170 has exceptional heat spreading and can cool up to 20,000 lumens in a round shape design. The efficiency of this design allows for the use of low cost compact LED arrays running at high currents without sacrificing color quality, brightness, or lifetime.

The R150-170 high bay solution reduces the total cost of ownership of the LED system by maintaining thermal performance over the life of the system, saving on maintenance costs for end-users. High bay LED luminaires require significantly less in maintenance costs than fluorescents or 400-watt metal halide systems assuming the LEDs meet their rated performance with effective thermal management. Customers will also realize more than 30 percent energy cost reduction from fluorescents and more than 40 percent from 400-watt metal halides.

LED lighting manufactures will also realize substantial cost savings with the R150-170 SynJet solution. Because of the R150-170 cooler's advanced thermal spreading and heat transfer capabilities, lighting manufacturers will be able to use smaller, less-expensive LED arrays and still achieve high color quality and lumen output. ■



15th anniversary 2013
1999-2013



15TH

CHINA INTERNATIONAL
OPTOELECTRONIC
EXPO

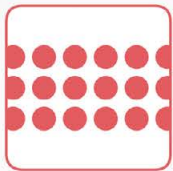

LED
TECHINA

A 360° View of the LED Industry

- Materials & Components
- Packaging & Modules
- Lighting & Display
- Manufacturing & Testing Equipments

SEPTEMBER 4-7, 2013

SHENZHEN CONVENTION & EXHIBITION CENTER · CHINA

CONCURRENT EVENTS:



OPTICAL
COMMUNICATIONS
EXPO



LASERS
INFRARED APPLICATIONS
EXPO



PRECISION
OPTICS
EXPO

For more information, please visit:

WWW.CIOE.CN



CHINA INTERNATIONAL
OPTOELECTRONIC
EXPO

CHINA INTERNATIONAL OPTOELECTRONIC EXPO OFFICE

Add: Room 607, East Block, Coastal Building, Haide 3rd Road,
Nanshan District, Shenzhen, Guangdong, 518054, China
Tel: +86 755 8629 0891 Fax: +86 755 8629 0951
E-mail: international@cioe.cn

MechaTronix - IceLED Modular Active LED Cooler

The IceLED product range is specifically developed for spot and down lights from 2000 to 8000 lumen (20 to 90 W cooling). Besides the high lifetime design >60Khrs (L10 life time at 25°C) and super silent working mode (<21dB at 1 m, including human and pets audible frequency range) these coolers offer a unique thermal performance and an aesthetic high end look.



MechaTronix's IceLED modular active LED cooler features a special super silent mode with less than 21dB at 1m, including human and pets audible frequency range

The IceLED is designed in this way that almost all available led engines in the market can be mounted without adding additional drilling or tapping costs, including LED holders from Tyco Electronics and reflectors from various manufactures.

All Zhaga compatible modules like the Philips Fortimo SLM, GE Infusion, Osram Prevaled, Tridonic Talexx Stark, Edison Edlilex, as well as some specific modules like the Bridgelux RS array, Citizen CLL030/040/050 series and the Xicato XPM & XSM LED engines can be mounted with standard self tapping screws M3x6 mm. ■

Dow Corning Introduces Advanced Silicone Technologies for LED Lamps

Dow Corning, a global leader in silicones, silicon-based technology and innovation, introduced an innovative new thermal management silicone technology for LED lamps and luminaires. These materials are part of their growing family of industry-leading LED lighting solutions.

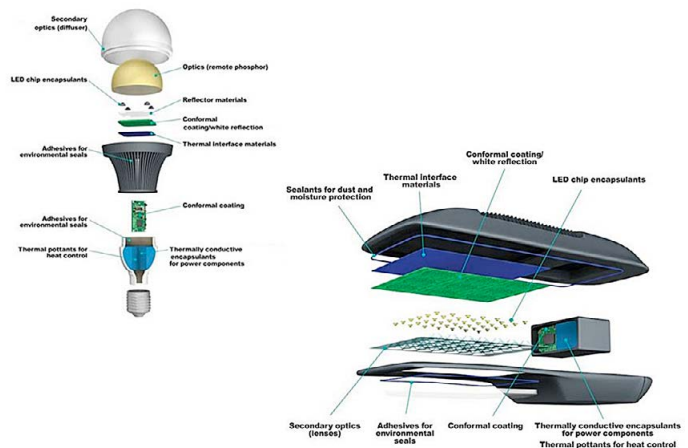

Dow Corning introduced new thermal management silicone technology for LED lighting applications

The company will conduct live demonstrations at its booth to spotlight how silicones can increase efficiency, expand LED design options and provide greatly improved processability, underscoring how these products are fast becoming the materials of choice in critical lamp and luminaire applications.

"The lighting industry is demanding greater brightness from increasingly smaller and more compact LED designs, causing lamps and luminaires to become progressively hotter," said Hugo da Silva, global industry director, Next-Generation Lighting at Dow Corning. "Heat is the enemy of LED performance, reliability and lifetime, and our new innovations will raise the bar with cost-effective options for combatting these higher temperatures. Combined with our extensive portfolio of high-performance silicone adhesives, coatings, encapsulants and optical solutions for LEDs, we will demonstrate at our booth how Dow Corning's silicone technologies are helping the industry overcome design challenges to pioneer next-generation, high-brightness LED lamps and luminaires."

Dow Corning's new-product introduction encompass four silicone-based materials designed to improve performance and reliability of LED lighting through enhanced thermal management. They will enable LED designers and OEMs to integrate multiple functions into fewer parts, or to incorporate smaller or more complex features. The new materials expand manufacturing options to help LED lamp and luminaire OEMs potentially lower the total cost of ownership of their products.

Dow Corning's also featured three demonstration stations that illustrate the many performance benefits the company's silicone technologies provide to the LED lamp and luminaire industry. The first station demonstrated the proven efficiencies that silicones can offer to LED light output. Station two showcased the tremendous design flexibility Dow Corning's materials offer; and the third station spotlighted the exceptional processability of silicones with live demonstrations of an injection molding machine producing optical silicone

components. These benefits and the advantages silicones offer vs. traditional materials will also be showcased in a wide array of demanding lamp and luminaire applications. ■

WEPESIL Silicone Casting Resin VT 3602 KK for High Power LEDs

Withstanding high optical temperatures of up to 150°C, the colorless and crystal-clear WEPESIL silicone casting resin VT 3602 KK is suitable for a use in optoelectronics, in particular when it comes to coating high power LEDs. Even when applied in high layers or when exposed to long-term thermal stress, this solvent-free 2-pack silicone elastomer displays a very high transparency in the entire wavelength range of visible light, as well as an excellent yellowing resistance.

PLCC Linear Module Series Edison Opto shines across the world

Features

- High Brightness SMD LED
- Low Power Requirement & Energy Efficient
- Suitable for Restricted Space

Typical applications

- General Lighting
- Office Lighting
- Parking Space Lighting

PLCC Linear Module Series

Panel Light Module

13W@ ET-3014

Tube Light Module

11.5W@ ET-3014

Tube Light Module

11.5W@ ET-5630

©2013 Edison Opto Corporation



Headquarters:

• 4F, No.800, Chung-Cheng Rd., Chung-Ho Dist., New Taipei City, Taiwan 23586

T+ 886 2 82276996 F+ 886 2 82276997 service@edison-opto.com.tw

• 1809 Excise Avenue, Suite 201, Ontario, California 91761 USA

T+ 1 909 947 0238 F+ 1 626 956 0754 service@edisonopto-usa.com www.edison-opto.com



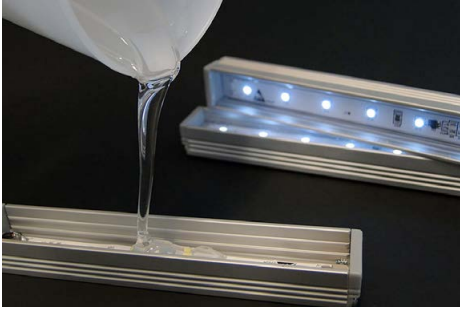

VT3602 KK is simple processable and highly weather and UV resistant

The WEPESIL silicone casting resin VT 3602 KK is highly weather and UV resistant, besides its very high elastic and tear resistant properties.

An optimum mixing ratio of 1:1 parts by volume or weight ensures a simple processing of this product. The WEPESIL casting resin VT 3602 KK is addition cross linking, thus avoiding the separation of substances in the curing phase. ■

AMEC Enters SSL Market with MOCVD Platform for HB-LEDs

At SEMICON China, Advanced Micro-Fabrication Equipment Inc. (AMEC) has made its Solid-State Lighting (SSL) market debut with a new multi-reactor Metal Organic Chemical Vapor Deposition (MOCVD) cluster tool. The Prismo D-Blue™ MOCVD platform enables high-volume manufacturing of sophisticated GaN, InGaN and AlGaIn ultrathin layered structures required for high-brightness LEDs. With precise parameter control, full automation and an unusually compact design, it's a new-generation MOCVD tool built for today's LED manufacturing must-haves: high productivity, high yields and lowest possible cost-of-ownership.



AMEC enters the SSL business with the Prismo D-Blue MOCVD tool

Hardware Highlights: The patented architecture can accommodate up to four reactors. Each reactor can be controlled independently—an inventive design that enables exceptional manufacturing flexibility. It is the only tool of its kind with this capability. This means it can process in parallel or sequential mode, which reduces cross-contamination and ensures the high crystalline quality required for advanced LED applications. The tool's footprint efficiency is unmatched—nearly 30 percent smaller than competitive single-reactor systems—making the Prismo a smarter fit for today's LED fabs.

Right Tool. Right Market. Right Time: Solid-State Lighting is a natural market move for AMEC. As an emerging innovation leader, the company provides advanced processing technologies and tools to the global semiconductor industry. Today more than 200 AMEC etch stations are operating in production at 16 leading semiconductor fabs across Asia. The silicon technology experience, process knowledge, disciplined R&D protocols and materials engineering pedigree that produced AMEC's semiconductor front-end equipment were applied to develop the Prismo D-Blue platform. AMEC's new LED customers will also benefit from the company's stringent supplier-management protocols.

The timing is good for a new MOCVD player—especially one with an R&D and manufacturing hub in Shanghai. Between now and 2017, the market for MOCVD tools is estimated to be \$4.3 billion, according to research firm Yole Developpement. China will continue to dominate global manufacturing activity. With bulb prices dropping, LEDs are becoming the de-facto alternative to traditional incandescent lights for retrofits and new builds. Cheaper bulbs mean tighter margins for LED manufacturers, which makes production efficiencies more essential than ever.

"The SSL market is an essential element of our growth strategy," said Dr. Zhiyou Du, Senior Vice President and General Manager of AMEC's MOCVD Product Business Division. "Our expert MOCVD technology team has created a differentiated, thoroughly flexible MOCVD platform with innovations to solve complex technical and production challenges. We're excited to offer customers this highly productive and cost-efficient alternative technology to make their advanced LED devices."

The Prismo D-Blue MOCVD Tool: Excellent Process Performance & Capital Productivity: The Prismo platform can process up to 216 2-inch wafers simultaneously. The processing capability will extend to 4, 6 and 8-inch wafer production. Beyond the multi-reactor architecture configured for maximum process flexibility, the Prismo excels in every key performance category. In marathon runs, the tool demonstrated breakthrough repeatability and excellent within-wafer and wafer-to-wafer uniformity. These results were achieved with no recipe adjustments throughout the entire epitaxial process. For a process with extreme sensitivity to chamber surface conditions, chemical environments, temperature shifts, and other variables, the repeatability performance is in a class of its own.

In the same marathons the system encountered zero process interruptions. The high reliability is enabled by in-situ, real-time monitoring of growth process parameters. It's also thanks to sophisticated software, advanced transfer modules, and process automation and control technologies—the same field-proven technologies that distinguish AMEC's semiconductor front-end processing tools.

Finally, the Prismo is optimized for easy maintenance—imperative in a fast-moving, cost-conscious LED production fab. Exceptional process performance and uptime extends the interval between services, while novel design features make servicing easier. Also, automated and programmable maintenance routines make reactor open/close operations safer, faster, predictable and less prone to error.

Special innovations embodied in the Prismo D-Blue MOCVD platform are protected by a portfolio of more than 100 patents (granted and pending). In addition, the tool follows semiconductor manufacturing disciplines and complies fully with SEMI standards. ■

Valtavallo LED Tubes Offer a Verified Efficiency of 119 lm/W

The Finnish LED tube manufacturer Valtavallo is launching a new version of its highly popular G3 LED tube with improved luminous efficacy. With a clear cover, the new G3 LED tube is designed for high-ceiling environments. According to SSL Resource, a LED lighting and photometric testing specialist, achieves a luminous efficacy of 119.2 lm/W.

"In high-ceiling environments, the luminance of individual bright LED components is not a major problem, as the light is generally viewed from a distance," says Tuukka Prykäri, CTO at Valtavallo.

"The luminous intensity distribution of the new product is better suited for high-ceiling environments, as the light is directed more vertically downwards," Prykäri continues.

The price of this latest product is the same as Valtavallo's "traditional" G3 LED tube with a semi-opal cover, meaning that the customer

can now decide which light is better according to the actual conditions. DIALux data files required in lighting design are available for use with the most common industrial luminaires sold by Valtavallo.



Valtavallo G3 LED tube is now manufactured with semi-opal and clear cover. The clear version delivers 119.2 lm/W in luminous efficacy

The G3 LED tubes are produced on a fully automated production line at Valtavallo's factory in Finland. There are no human work stages in the automated assembly process and so the possibility of human error in production has been eliminated. In order to ensure that every G3 LED tube is of the highest quality, the unit-specific testing process after assembly consists of versatile electrical and lighting-related technical inspections. ■

360 Degree LED

360 Degree LED

Shenzhen Good-Self Lighting
Technology Co., Ltd.
sale@gszmlighting.com
www.gszmlighting.com

3rd Annual Executive Congress on LED Lighting

Towards a Brighter, Greener India

09 July, 2013 - New Delhi

Increasing awareness about energy-efficient technologies as well as the growing efficacy of light-emitting diode (LED) lighting products is triggering massive growth in the Indian LED lighting market even as it battles the challenges of high cost, penetration of sub-standard products, and lack of an ecosystem for indigenous manufacturing.

Frost & Sullivan's Electronics & Security Practice will host its 3rd Annual Executive Congress on the Indian LED lighting market titled, **'Toward a Brighter, Greener India'** on 9th July, 2013 in New Delhi, which will address the various challenges faced by LED lighting suppliers and end users.

Frost & Sullivan's recent update on the LED lighting market in India indicates the market will witness a stupendous cumulative annual growth rate (CAGR) of 43.9 percent from 2011 to 2018 and scale revenues of \$1.2 billion by 2018.

Year	Revenue (\$ Million)	Growth rate (%)
2010	~100	~10
2011	~150	~20
2012	~200	~30
2013	~250	~35
2014	~350	~40
2015	~450	~45
2016	~600	~40
2017	~800	~35
2018	~1200	~30

Research further highlights that faster RoI, higher price-performance value, and Government thrust are enabling faster acceptance and adoption of LED lighting in India.

More than 4 years of continuous monitoring of developments in the LED lighting industry has provided Frost & Sullivan the thought leadership to convene and host conferences to debate the challenges, future opportunities, and roles of different stakeholders.

This event is a must-attend for all companies/individuals with interest in the Indian LED lighting market. Apart from knowledge gathering on future prospects for the market and its evolving dynamics, the event is poised to facilitate business interactions that can evolve into long-term rewarding relationships. Participants will benefit from insightful and strategic discussions involving industry experts and earn the opportunity to meet and network with peers and potential customers.

Whom to Expect at the Event

- Municipal Bodies Rural Administrators, Railways
- Automotive, Signage/Displays, Manufacturing, Hospitality, Builders, Developers
- Semicon Cos, Design Cos., ESCOs, Certifying Bodies, Lighting Consultants/Contractors, Electronics Distributors, Architects
- Lighting OEMs, Luminaire Manufacturers, Product OEMs
- Investment Community, PE Firms

Joining Frost & Sullivan as its **'Strategic Partner'** in this 3rd edition of the LED lighting conference is the LED industry's premier representative body, the **LED Manufacturer's Association (LEDMA)**.

This event promises to provide an ideal platform for business networking and engaging interactive sessions by bringing together the who's who of the Indian LED lighting sector.

Media Partners

To know more about the summit, please contact:
Akshata Mhatre
P: +91.22.6607 2020 | Email id: akshatam@frost.com

Forge Europa - Most Powerful GU10/MR16 Replacement Lamps

Forge Europa is revolutionizing the LED lamp replacement market by developing a true and proven LED based replacement for a 50 watt GU10 and MR16 Halogen.



Forge Europa's new GU10 and MR16 replacement lamps offer 670 lm at 9.5 W and 590 lm at 7.5 W resulting in ground breaking 70.5 lm/W and 78.7 lm/W respectively

The company identified a key opportunity to push the boundaries of LED technology and the development team produced a specification to create an industry first true 50 watt replacements for the halogen MR16 and GU10. Identifying the key performance criteria; flux, intensity, beam angle, life, CCT, efficacy and form factor optimization.

The results are ground breaking; revolutionizing industry highs for flux and associated efficacy. With the high performance GU10 LED lamp achieving typically 670 Lumens; this brilliant and compact 9.5 watt GU10 LED lamp has a market leading efficacy of 70.5 lm/W, CRI of 80 and 1,091 Cd from the 36 degree beam. The 7.5 watt MR16 also packs a powerful performance punch with 590 Lumens, efficacy of 78.7 lm/W, CRI of 80 and intensity of 962 Cd for the 36 degree beam.

Forge Europa has distilled over 20 years of expertise and award winning innovation in to the development of the lamps, ensuring all aspects are intelligently and optimally engineered from thermal management through to electronic design.

Forge Europa's status of Cree Solutions Provider enabled the integration of cutting edge LED technology maximizing lumen output whilst minimizing power consumption: essential criteria in delivering this industry first and future proofing the design.

Grant Huck, Business Development Leader adds: "There exists a trend of considerable disparity between actual 50 W Halogen flux and the flux of claimed 50 W LED equivalents. Our challenge was not insignificant, especially considering the size and market position of our competition. We aimed to raise the bar well above the levels set by strong leading brands and demonstrate our capability as a leading LED technology provider. We succeeded."

Two specific versions of the GU10 have been engineered to maximize compatibility with recessed / Fire-can luminaires and also track / surface mount spot light fittings.

The MR16's unique and proprietary electronic design maximizes compatibility with electronic low voltage transformers, so much so that a specific 'compatibility list' is no longer required! This is one lamp designed for hassle free retrofit and new installations.

Mark McIntosh, Projects Leader and LIA Technical Lamp Committee Member adds: "Such performance levels present significant benefits to all customer demographics; from lighting designers through to facility managers - these lamps offer a superior drop-in replacement without having to worry about diminished light levels." ■

Lextar Releases Highly Efficient 8-foot T8 LED Tubes

Lextar Electronics Corp. announces the release of 8-foot T8 LED high-efficiency tubes, using Lextar LM-80 certified LED packaging products. The tubes have 110 lm/W and above efficiency, and are expected to be mass produced in Q2 2013, upon which one of Lextar's main Japan-based brand customers will received first shipments. Lextar showcased the technology for the first time to the public at the Taiwan International Lighting Show (TILS 2013).

The 8-foot (2.4 meter) lamp provides 40% higher efficiency compared to fluorescent lamps, and is able to achieve light uniformity with linear T8 dimension, making the lamp technology a breakthrough in terms of surpassing production, assembly and material restrictions, as well as an appropriate substitute for the traditional 8-foot T8 lamps.



Lextar's newly introduced 8-foot (2.4 meter) lamp provides 40% higher efficiency compared to fluorescent lamps

The new T8 LED lamp has a lifespan of 40,000 hours (five times the length of fluorescent lamps), and has a lightweight design to ensure safety, making the technology very suitable for stores, warehousing, bus/train stations, tunnels and other public places that use lighting for long periods of time. The highly energy efficient lamps will help customers save on maintenance costs and on energy costs. Additionally, the technology is also being set for T10 specifications as well as for GX16 and R17 lamp holder for aim at various Japan-, Asia Pacific- and Europe-based markets. ■

Cree Designs Price Breaking LED Lamps for The Home Depot

Cree introduces a game-changing series of LED bulbs at a retail price point that gives consumers a reason to switch to LED lighting. The new bulbs shine as brightly as comparable incandescents while saving 84% of the energy compared to traditional bulbs. The Cree LED bulbs are backed by a 10-year limited warranty and available exclusively at The Home Depot®.



The 40 watt version is available for less than \$10 and the 60 watt versions cost less than \$15



Unique.

Nuventix offers a wide array of heatsinks and SynJet® Coolers. Solutions can be used passively or with quiet, reliable active cooling to create smaller unique designs.

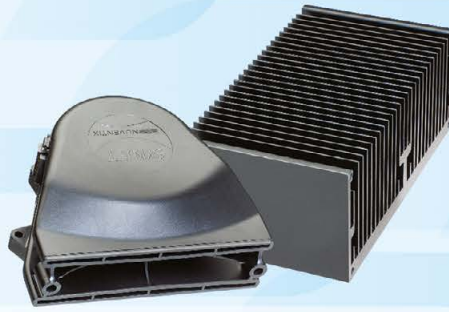

Rugged.

Nuventix' outdoor thermal management solutions are the most rugged and dependable available: proven tough against dust, high heat and rough weather conditions.



Effective.

New high bay industrial solutions cool up to 20,000 lumens in smaller, lighter form factors that allow for lower cost arrays.

Applications:

Downlights
Tracklights
High Bay
Low Bay
Outdoor

Available for:

Bridgelux Philips
Citizen Tridonic
GE Vossloh Schwabe
Osram Xicato
Sharp Cree

SynJet® Coolers are designed with patented technology that allows for reliable, more efficient cooling in smaller form factors.

Custom heatsink solutions can be designed for LED arrays and luminaires.



For more details:
Nuventix.com

ELECTROLUBE®

Choose the right protection... and get maximum performance!

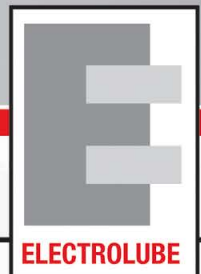

Electrolube products are specified and widely used throughout many markets and for an array of applications, **LED's being just one speciality!**

Highly Thermally Conductive RTV

TCOR and **TCER** are high thermal conductivity, solvent free RTV silicone bonding compounds, providing excellent electrical insulation and chemical resistance. Both are moisture cured. **TCOR** is ideal for spot application while **TCER** is easier to spread over a contact area.

Thermal Paste

HTSP Silicone heat transfer compound plus. Superior thermal conductivity even at high temperatures 3.0 W/m.K. It has excellent non-creep characteristics and wide operating temperatures -50°C to +200°C.

High Performance Acrylic

HPA, is a flexible, fast drying transparent, non-yellowing acrylic conformal coating for the protection of LED components and electronic circuitry.

Clear Silicone Resin

SC3001 is an optically clear Silicone two part potting compound ideal for use wherever high clarity is required. **SC3001** can encapsulate LEDs with minimum light loss but a high level of environmental protection. Its low viscosity allows very easy application even in thin films.

Clear Polyurethane

UR5562 is a semi-rigid optically clear high performance resin ideal for use in LED and protective applications.

For more information visit...
www.electrolube.com



"The Cree LED light bulb was designed to offer consumers a no-compromise lighting experience at a compelling price," said Chuck Swoboda, Cree chairman and CEO.

"As the leading retailer of energy-efficient LED lighting products, our customers look to us to provide them with the most advanced and most cost-effective lighting technologies available," said Jeff Epstein, merchandising vice president, The Home Depot.

The innovative bulb is illuminated by Cree LED Filament Tower™ Technology and provides a compact optically balanced light source within a real glass bulb to deliver consumers the warm light they love and want. Boasting a shape that looks like a traditional light bulb, Cree LED bulbs can be placed in most lighting fixtures in the home. The new Cree LED bulb is designed to last 25,000 hours or 25 times longer than typical incandescent light bulbs – reducing the need to replace bulbs for years to come.

With a retail price of \$9.97 for the warm white 40 watt replacement, \$12.97 for the 60 watt warm white replacement and \$13.97 for the 60 watt day light, the Cree LED bulbs save 84 percent of the energy compared to traditional incandescents. Cree LED bulbs can pay for themselves quickly.

Cree's 60 watt LED replacement light bulb delivers 800 lumens and consumes only 9.5 W and is available in warm white (2700 K) and day light (5000 K) color temperatures. The 40 watt LED replacement bulb delivers 450 lumens and consumes only 6 watts and is available in 2700 K color temperature. ■

Philips' Latest LED Luminaire is BoldPlay for Building Owners

Expanding on its commitment to deliver innovative products that can help organizations meet their energy and lighting goals, Philips Ledalite introduces BoldPlay, a new portfolio of high-performance LED lighting systems that is 44 percent more efficient and consumes 28 percent less energy than traditional technologies like fluorescent. Integrating daylight harvesting with the latest Philips LED technology and advanced optics, BoldPlay is the latest in the

Philips' family of luminaires to offer building owners a flexible, intuitive lighting solution that allows for fewer fixtures in a space, while delivering all the light quality, energy efficiency and cost savings that have become hallmarks of Philips products.



BoldPlay from Philips offers numerous control options. It not only takes advantage of its high efficiency of up to 106 lm/W but also sophisticated daylight- and presence control options

Delivering up to 106 lm/W, one of the highest in the industry, BoldPlay allows for wide row spacing at up to 20 feet apart, while maintaining uniformity on the ceiling and workplane. BoldPlay's performance, combined with its simple, clean design, make it ideal for a variety of applications, including office, education, healthcare and retail. The product's LED light engine is comprised of a low profile Light Guide Panel which helps extract and reflect light into a precisely controlled direct/indirect distribution. BoldPlay also integrates patented MesoOptics nanotechnology which makes spaces more visually comfortable by optimally blending light and color, while controlling high angle glare. In addition, BoldPlay features optional Response Daylight harvesting sensors that can extend LED sustainability benefits by further reducing energy consumption up to another 35%.

"Most buildings use lighting technologies that date back to the 1980's, yet as organizations look to become greener, while trying to provide a better work environment, lighting upgrades become an obvious choice," said Don Jacklin, Director, Product Management for Philips Ledalite. "Not only does BoldPlay offer significant energy savings and better light quality than traditional lighting systems. Airwave occupancy sensors harvest that ambient light to power themselves and then adjust the room's lighting based on whether or not it is occupied. BoldPlay makes energy efficiency intuitive and, with its ease of installation, adopting LED technology has never been simpler."

BoldPlay offers many flexible options including a range of aesthetic designs, LED color temperatures, distribution choices, and a complementary wall mount version. In addition, BoldPlay is designed to work with optional Airwave Wireless Controls and features an easy "plug and play" installation that simplifies upgrades or replacement. ■

OMS Lighting Redesigned Grafias to Provide 123 lm/W

OMS Lighting announced the addition of the redesigned Grafias luminaire - featuring efficacy values of 123 lm/W, to its product portfolio after a series of successful laboratory tests. According to the product's design team, Grafias is the result of a creative and productive cooperation and introduces many unconventional solutions that make the luminaire stand out.

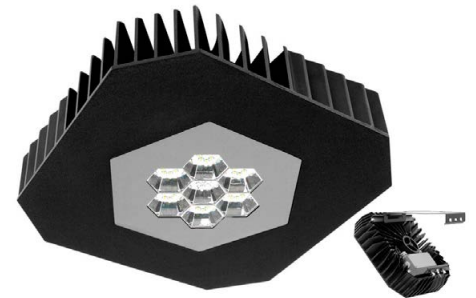

Grafias from OMS Lighting is a very efficient and versatile luminaire for industrial applications

The suspended, surface mounted or recessed LED luminaire with a luminous flux of 17,200 lm is characterized by an unconventional design and exceptionally efficient optics. An optimized heat dissipation solution, based on convection, enables the luminaire to achieve its low weight. Grafias reaches an extremely long lifetime of up to 100 thousand hours thanks to the LED light source used. Its high degree of IP protection, IP 65, ensures its reliable operation even in areas that are demanding on the luminaire's resistance such as storehouses, industrial areas and petrol stations.

The luminaire's unique design and parameters are the result of a close collaboration between the product design team and specialists from the company's optic design, electronic design and thermal design departments. ■

Premium Lighting Solutions Launches First Waterproof Planar LED Fixture

Premium Lighting Solutions (PLS), a manufacturer and supplier of leading lighting technologies into commercial, public and industrial buildings, has launched a new waterproof energy efficient light fitting. The IP65 LED panels are particularly suited to those industries that need to maintain an exceptionally clean environment, such as food preparation and healthcare.



PLS claims their planar LED panels to be the first waterproof LED panels on the market

The fitting is a waterproof version of PLS' existing LED panels, which offer energy savings of over 70% when compared with traditional lighting technology.

The panels, which are the first waterproof LED panels on the market, fit flush to the ceiling and are able to withstand any kind of cleaning process including high power jet and pressure washers. Other LED panels currently available tend to become damaged by water or are cracked by the excessive force of the cleaning process.

Other features of the panels include:

- Only 10 mm thickness – one of the thinnest lighting panels on the market
- No glass in the composition guarantees safety for food production areas
- High Colour Rendering Index ensures that reflected colour looks the way it should

Fully waterproof power supply Keith Wyatt, Commercial Director, comments: "The waterproof IP65 LED panels were designed for the food production market but offer an efficient, durable solution for all industries that want to improve their energy usage and need to maintain especially hygienic surroundings. Until now, companies operating these kinds of industries have been restricted in the fittings that they can use because those available lack the necessary resilience. We believe that this product offers the answer." ■

25 – 27 November 2013
The Exhibition Center - Olaya Street
Riyadh - Kingdom of SAUDI ARABIA



The future of Light & Sound is here



Sponsored by
Minister of Trade and Industry
Dr. Tawfeeq bin Fosan AlRabeia'a

About Light & Sound Expo

L&S Expo it's the first of its kind in KSA links buyers with suppliers attracting a mix of leading international manufacturers, regional distributors and production/rental companies providing professional sound, lighting, audio visual and systems integration equipment and solutions. Exhibitors can promote their products and service through this exhibition and get excellent opportunity to increase exposure and sales.

"The Saudi market constitutes a favorable chance for foreign investors"

- Kingdom of Saudi Arabia ranks 23 within the major twenty five economies in the world.
- Saudi Arabia ranks the first within the major economies in Middle East and North Africa.

It also ranks 13 within 183 countries in international classification in terms of easy business performance according to the report of "business performance practice" for year 2011 issued by International Fund Organization affiliated to the World Bank.

Why Exhibit?

- Dramatically raise the awareness of your products and services overseas.
- Generate international PR coverage.
- Launch a new product to the international market.
- Meet new customers from around the world.
- Support your distributors/partners/retailers.
- Be part of the industry community.

Administration: Email. batola.co@hotmail.com

For Local Participants: Mobile. 00966598137517 / 00966541194994
Email. batola.co@hotmail.com
alanoud.batola@hotmail.com

For International Participants: Mobile. 00966541188238 - 00962795343278
Email. shatha.batola@hotmail.com
murad.batola@hotmail.com

Media center: Mobile. 00966544224564
Email. al-shaima.batola@hotmail.com

www.light-soundshow.com

[/LightSoundsyste](https://twitter.com/LightSoundsyste) [/LightSoundExpo](https://facebook.com/LightSoundExpo)

Organizers



LightFair 2013 Awards - The Winners

The 2013 LIGHTFAIR® International (LFI) Trade Show and Conference was held in April in Philadelphia, with most attendee categories creating new levels of record attendance. In its 24th year, LFI provided more than 18,000 m² for over 500 exhibitors of which more than 80 were first time exhibitors. For 2013, two new product categories (solar power and software) and a new Exterior and Roadway Lighting Pavillion were added attractions. This architectural and lighting equipment show is produced and managed by AMC, Inc. and this year's attendance must have been very gratifying to AMC and its two sponsors, The Illuminating Engineers Society (IES) and The International Association of Lighting Designers (IALD). LFI is well recognized as the world's largest annual architectural and commercial lighting trade show and conference. The candidates for its celebrated award winners, judged by independent panels of renowned lighting professionals, are closely monitored since they usually highlight the most notable products and designs introduced during the 12 months preceding the event.

Most Innovative Product Award® for Philips' BoldPlay Luminaire

The highest award for 2013 was presented to Philips for its BoldPlay Ledalite Luminaire, which was introduced only a couple of weeks prior to LFI and announced Philips' latest LED Luminaire for commercial building owners. For the company, it provided its first and highest level LFI Award® in the innovative product of the year category.

The Ledalite BoldPlay is a new rectangular packaged, high-performance LED lighting system that is 44% more efficient and consumes 28% less energy than traditional technologies like fluorescent, but with the advantage of individual lamp control and better light quality. BoldPlay integrates daylight harvesting with the latest Philips LED technology and advanced optics, and it is the latest in the Philips' family of luminaires to offer building owners a flexible, intuitive lighting solution that allows for fewer fixtures in any space, while delivering all the light quality, energy efficiency and cost savings that are now desired by building owners, builders or lighting providers.

BoldPlay luminaires offer three standard color temperatures of 4000, 3500 and 3000 K where the 4000 K output is 3400 lm at 106 lm/W, one of the highest efficiencies in the industry. A high output version of the 4000 K luminaire provides 4800 lm, but at the slightly lower 102 lm/W efficiency. The design of BoldPlay enables wide lamp-row spacings of up to 20 feet (using less energy), while maintaining lighting uniformity on the ceiling and the work plane below. Its simple, clean design, make it ideal for a variety of applications, including office, education, healthcare and retail space. The product's LED light engine is comprised of a low profile Light Guide Panel which helps extract and reflect light into the precisely controlled direct and indirect distribution format. Also integrated is the patented MesoOptics nanotechnology, which makes spaces more visually comfortable by optimally blending light and color, while controlling high angle glare and the BoldPlay technology features optional Response Daylight harvesting sensors that can extend LED sustainability and further reduce energy consumption by up to an additional 35%.

"Not only does a system like BoldPlay offer significant energy savings and better light quality than traditional lighting systems, it can sense the ambient light in a room and adjust itself accordingly. Airwave occupancy sensors harvest that ambient light to power themselves and then adjust the room's lighting based on whether or not it is occupied.," said Don Jacklin, Director, Product Management for Philips Ledalite products. "BoldPlay makes energy efficiency intuitive and, with its 'ease of installation', adopting an LED technology has never been simpler." BoldPlay's many flexible options including a range of aesthetic designs, LED color temperatures, distribution choices, and a complementary wall mount version were obviously some of the considerations used by the judges in making this award. In addition, BoldPlay is designed to work with optional Airwave Wireless Controls and features an easy "plug and play" installation that simplifies lighting upgrades or replacements. Airwave allows for traditional 3-way control schemes that limit dimming to occur from just one hardwired location. With no hardwiring and no batteries to worry about, its self-powered kinetic energy devices deliver full range dimming and ON/OFF control from anywhere in a space.

Hue Provides Philips with a Second LFI Award®

The LFI Judges' Citation Award®, a special recognition of an innovative product awarded at the judges' discretion, provided Philips with a second LFI Award® for LEDs for its Hue system LED bulb. This is a personal wireless lighting product, which is the "world's first Web-enabled LED home lighting system available directly to the consumer". According to Philips, Hue is the "World's smartest LED light bulb" and will "Usher in a New Era of Connected Lighting for the Home."

According to Bruno Biasiotta, CEO and President of Philips Lighting North America, "Hue is a game changer in lighting, not just in offering great light quality, but in how lighting can be digitized and integrated with our world to further simplify and enhance our lives." Evaluation on three continents indicated high levels of consumer acceptance in such areas as; controlling their lighting from outside the home plus the ability to save personal light settings and recreate them at the touch of a button.



BoldPlay's design produces 70% of its light into an indirect or "upper hemisphere" and 30% from its "batwing" or direct lower hemisphere, a combination that enables no direct view of the LEDs, lower power densities, glare free task illumination, excellent uniformity and the wider row spacings



To promote the acceptance of the web-enabled Hue LED home lighting system, Philips is offering a starter kit that includes three LED bulbs that fit into any standard light fixture and a bridge that connects to existing wireless routers

Philips' Hue is reported to set up in minutes and, with a quick download of the Hue application, the system can be controlled from any Apple iOS or Android device. By using the application, consumers can remotely control their home lighting for added security, personalize their lighting experience with custom settings, or program timers to help manage daily schedules, all by the use and convenience of their mobile smart devices.

With the Hue LEDs, lighting can be digitized since their small footprint and semiconductor design allows them to be easily integrated into electronic circuitry. It is this seamless integration into electronic circuits which allows them to deliver unique light outputs on the command of electrical signals. This has enabled Philips to build smart bulbs into a system where every light bulb is a node and has a unique web address that can be integrated with software applications such as the one supplied with Hue. Philips is developing future product features, such as allowing Hue to integrate with other media including sound and video. Further, the company is working on features such as geo-location services, allowing hue to sense when a user is close to home and automatically turn on the lights, or turn the off when the user has left and is also researching the application of reverse indicators, enabling the Hue sensor to alert the system that the lighting has not been turned on during a specific time period, which offers numerous possibilities around senior care.

With the launch of its software developer program for Hue, Philips now allows consumers to create and control their light bulbs using a Smartphone or tablet. With the recent publishing of Hue's open application programming interfaces (APIs), as well as

releasing guides and libraries in iOS software, Philips is helping the developer community to start programming with Hue. This move opens the playing field for third party developers to create new, exciting applications using light, enabling Hue to communicate with a variety of devices and applications.

Already external developers have created applications that integrate Hue with music, resulting in an immersive surround sound and surround lighting experience that allows the lighting to change to the beat of the music. Developers have also created scheduling applications that can integrate with a computer or phone's calendaring system. "Already Hue is sparking a digital revolution in home lighting, as well as becoming an important step towards automated, connected homes, allowing it to further integrate with our world and simplify our lives," said Kevin Toms, SDK Designer and Developer Advocate of Hue's software developers' platform.

Using the ZigBee LightLink standard, Hue bulbs can not only communicate with each other, they have the potential for communicating with other ZigBee-based devices such as motion sensors and home thermostats, while offering a broad signal range and consuming significantly less stand-by power than traditional Wi-Fi systems. Software updates for the bulbs are done automatically via the bridge and the bulbs themselves, and additional applications developed for the system will be made available through application stores or at meetHue.com, making it easy and intuitive for users to update Hue with applications and functionality that will enhance their lighting experience.

Hue's application already includes numerous pre-programmed light settings, including Light Recipes based on Philips' research around lighting's optimal effects. These pre-programmed scenarios adjust the bulbs to the optimum shade and brightness of white light to relax, read or boost mood and energy. However, there is additional opportunity with color temperature applications that have the potential to help photographers adjust lighting for shots with a simple programme on their smart devices.

Dow Corning Receives Technology Awards® for Two LED Products

This year Dow Corning was also honored with two LIGHTFAIR® International (LFI®) Innovation Awards®. Specifically, Dow Corning beat 307 contenders to earn the prestigious Technical Innovation Award, described by LFI as one of its top honors for outstanding achievement in design and application with two products – Dow Corning® MS-1002 and MS-1003 Moldable Silicones – which beat 15 competing products to win Best Product in LIGHTFAIR's Non-Luminous Components and Specialty Hardware category.

The Dow Corning MS-1002 and MS-1003 Moldable Silicone encapsulants retain superb clarity and mechanical performance over the course of an LED lamp or luminaire's lifetime. This quality is becoming more attractive for packaging as LED sources are increasingly expected to deliver more intense white light from comparatively smaller package sizes, both of which raise operating temperatures at the chip level, especially as customers demand smaller designs with higher luminous flux.

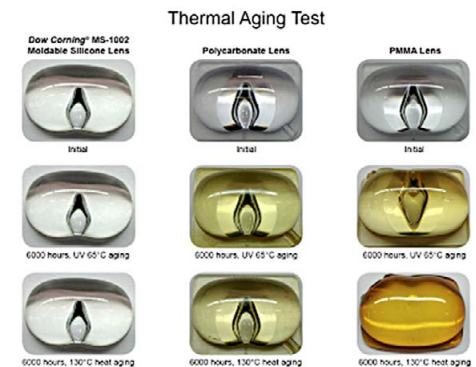

Non-silicone LED materials, such as epoxies, polycarbonates and acrylics can yellow and physically degrade after prolonged exposure to temperatures of 150°C and high lumen density illumination

Eric Peeters, the vice president, Dow Corning Electronic Solutions noted his company's appreciation of the awards with his recent comment: "Winning these two awards is a true honor, and further highlights Dow Corning's role in the LED lighting sector as a reliable innovation partner and full-service global provider of optical-grade silicone solutions. We deeply appreciate LFI's recognition of our high-clarity moldable silicones, which deliver breakthrough mechanical, thermal and optical stability as the increasing heat and lumen density of new LED designs challenge traditional organic optical materials."

Cooledge Light Sheet Receives the Design Excellence Award®

The LightFair® International Design Excellence Award® went to Cooledge Lighting, a Canadian LED lighting technology company who is currently celebrating both its corporate and product launch for its flexible LED lighting system. It was named the category winner in the LED, OLED, chips and modules category.

The new lighting medium combines the mechanical, electrical and LED source together into a flexible sheet of light. This flexible LED light engine operates with 120 lm/W efficacy, CRIs above 80, and an expected 50,000 hour life to LT-70. The light sheets themselves are available in widths from 1" (28 mm) to 11" (280 mm) and in lengths up to 8 feet (2.4 m).

The Cooledge Light sheet will redefine the geometry of LED light engines and offers a new flexible medium for LED lighting that will enhance today's and future markets and that will extend the range of products enabled by the sizes of LED-containing light sources offered. These flexible strip or sheet LED light sources will offer tomorrow's luminaire designers a whole new range of high brightness design options, including light emitting wall coverings. Luminaire designs using the LED light sheets can be fluid and minimal, also permitting unique material choices in many cases. Based on Cooledge's patented technology, this new medium of light requires no additional heat-sinking or thermal management. ■

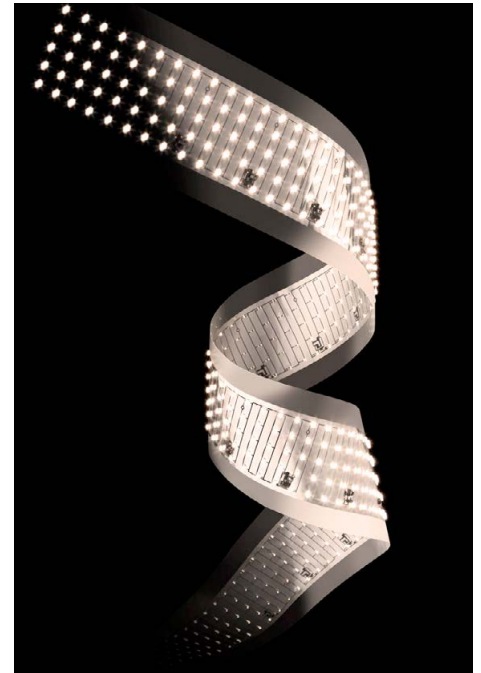

The unique form factor of Cooledge's LED light sheets allows large panels, long lengths and the ability to conform to a wide variety of shapes - eliminating many of the constraints and challenges imposed by traditional LED lighting options



New 60V DC/DC LED Drivers Improve Efficiency, Light Quality and Operating Lifetime

The products ILD6070 and ILD6150 have a maximum current capability of up to 0.7A and 1.5A respectively. The ICs offer excellent power conversion efficiency up to 98%, benchmark current accuracy of +-3% across the load from 4.5 – 60V that helps assure constant light output, and first-in-the-industry adjustable over-temperature protection that protects LEDs from damage through overheating. The products are defined as general purpose LED driver ICs, mostly to be used in professional lighting systems, luminaires and electronic control gears.



www.infineon.com

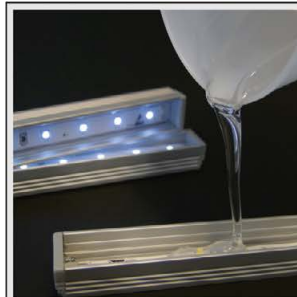

ELPELIGHT® products for LED technology

Light effects, such as diffusion or absorption for example under LEDs, can be avoided or indeed created with various lacquer systems for substrate coating. Casting resins or conformal coatings protect outdoor LED applications against environmental influences but also fulfil highest functional optical demands like very high transparency and UV light stability.

Please contact: peters@peters.de, www.peters.de

For the realisation and protection of LED applications



WEBINARS



Obtaining the Highest Candle Beam Power for Spotlights

Lumen density in the LED source is very significant in final design. Obtaining Center Beam Power is a goal in high quality applications including retail and architectural lighting. High Power LEDs are the perfect solution to creating high lumen intensity from a very small light emitting source. Creating a very high lumen per mm square enables the highest center beam candle power in a system. Where other COB's need ~35-35mm for high lumen packages, LUXEON S5000 can achieve 8000 lumens in a Light Emitting Surface of just 17mm. Creating great spotlights has never been easier.

To view the webinar, register at www.led-professional.com/webinars

PHILIPS
LUMILEDS

THE PERFECT COUPLE

DIMMER COMPATIBILITY FOR LED_s SIMPLIFIED!

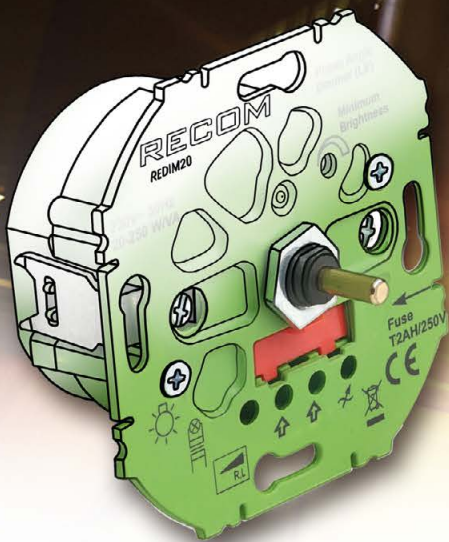

REDIM – THE DIMMER SERIES FOR LED LIGHTING

- LEADING-EDGE DIMMER
- OPERATES AT A MINIMUM LOAD OF 7W
- ADJUSTABLE BASE LEVEL BRIGHTNESS
- INTEGRATED THERMAL PROTECTION

RACT LED DRIVER - FLICKER FREE DIMMING DOWN TO 0%

- DRIVES LED_s UP TO 56V
- OUTPUT CURRENT UP TO 1A
- ENEC/UL8750 CERTIFIED
- 5 YEAR WARRANTY

FL Replacement LED Tubes - Challenges and Technologies

Currently, T8 replacement lamps are downright flooding the market. Manufacturers as well as retailers are advertising these products to be better and more cost effective than fluorescent tubes. These promises were a good reason for Arno Grabher-Meyer from LED professional take a closer look at the facts and status of LED technology for replacement tubes.

Fluorescent lamps are one of the most wide spread light sources. They are efficient, and if not broken, environmentally friendly. But if damaged, they set highly toxic mercury or, amalgam free. This and the inferior light quality of some of the early products are some of the main reasons why the LED industry was challenging these products at an early development stage of LED technology. In particular, T12 and T8 lamps are very often replaced by LED tubes, while T5 lamps have not been affected that much up until now. This leads to the question of whether it makes sense nowadays or if further development steps in LED technology are required.

T8 Lamps - Myths or Reality

Myth one: T8 lamp systems are inefficient

This is true for the older generation of magnetic ballast powered products. Not the light source itself is inefficient, but the ballast in combination with low-frequency operation. The latest EU regulation requires highly efficient ballasts and very similar regulations have been introduced in many other regions of the world as well. Under certain conditions and in the right application, T8 systems can even outperform their T5 relatives which are still recognized to be a benchmark for efficient lighting systems. While T5 lamps are optimized for an ambient temperature of 35°C, T8's are optimized for 25°C.

T8 lamps differ not only regarding the optimal temperature from T5 lamps, but also in tube diameter. Both factors affect luminaire performance. The smaller lamp diameter of T5 lamps can increase efficiency of optical control and flexibility of luminaires for some applications. Which system is preferable has to be carefully verified and strongly depends on the application.

Myth two: T8 lamps have a short lifetime

All fluorescent lamps are specified under defined conditions. For instance: DIN EN 60081/IEC81 with a switching cycle of 2 ¼ hours on and ¼ hour off. In addition, the number of switching cycles is also specified. Lamps operated on longer burning cycles will

Table 1:
T8 performance compared with T5 tubes under the same conditions

T5 Tubes							T8 Tubes			
Length	Watts HE	Luminous Flux HE	Efficiency HE @ 25°C	Watts HO	Luminous Flux HO	Efficiency HO @ 25°C	Length	Watts	Luminous Flux	Efficiency @ 25°C
563 mm (22.2 in)	14 W	1200 lm	86 lm/W	24 W	1750 lm	73 lm/W	2 ft, 600 mm	18 W	1350 lm	75 lm/W
863 mm (34.0 in)	21 W	1900 lm	90 lm/W	39 W	3100 lm	79 lm/W	3 ft, 900 mm	30 W	2400 lm	80 lm/W
1,163 mm (45.8 in)	28 W	2600 lm	93 lm/W	54 W	4450 lm	82 lm/W	4 ft, 1200 mm	36 W	3350 lm	93 lm/W
1,463 mm (57.6 in)	35 W	3300 lm	94 lm/W	49 W 80 W	4300 lm 6150 lm	88 lm/W 77 lm/W	5 ft, 1500 mm	58 W	5200 lm	90 lm/W
							6 ft, 1800 mm	70 W	6200 lm	88 lm/W

Figure 1:
Light output of
T5 and T8 tubes
versus ambient
temperature

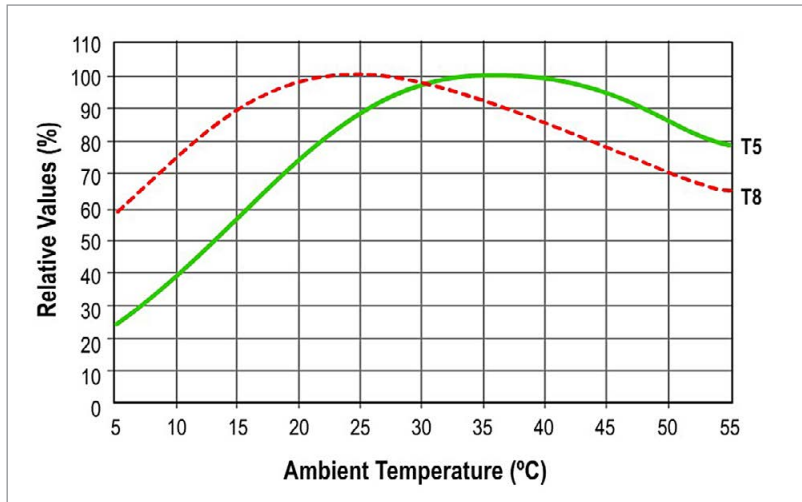
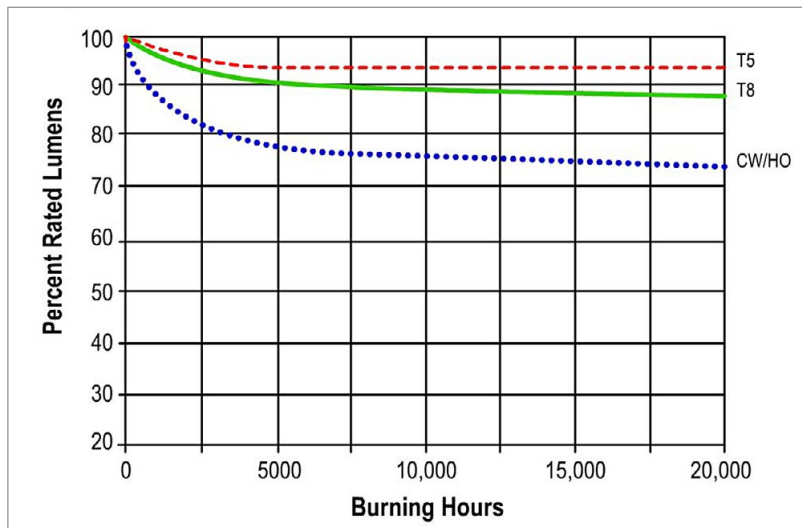

Figure 2:
Lumen
maintenance
of different
fluorescent tubes



have longer life spans. Shorter burning cycles (frequent switching on and off) reduce lamp life. Meanwhile, T8 lamps are also available as “long-life” versions with a declared lifespan of up to 80,000 hours, but these are niche-products and high-priced.

Myth three: Luminous flux of T8 lamps decreases very rapidly

There are rumors circulating that say the light output of T8 tubes decreases to below 70% or even 50% within a few hundred to a thousand hours. This is especially not true for state-of-the-art products. Yes, it is correct that within the first one to three thousand hours a relatively fast decrease can be seen. However, good standard-lamps retain almost 90% of the initial output until the end of their lifespan at about 20,000 hours.

Myth four: T8 lamps provide poor light quality

In the beginning there were only simple phosphors used for fluorescent lamps. Meanwhile T8 lamps have three-band phosphors similar to T5 lamps. Next to an increased lifespan, these phosphors guarantee sufficient light quality. Depending on the application, one may choose products with a color rendering index from 62 up to 98. Standard lamps have a CRI of 80+, and even CRI 90+ lamps are easily available.

Myth five: T8 systems are low-cost products

There are certainly cheap goods on the market, but quality T8 systems are not low-cost products. The technology used is the same as that used for T5 lamps. These systems consist of a good optical system, efficient

electronic ballast, and a high quality tube. In the case of a “long-Life” tube the cost may be about the same as a cheap luminaire.

T8 Lamps Facts

The design for the T8 FL lamp concept is several decades old. Since their introduction, numerous upgrades and improvements have been introduced. Originally equipped with simple magnetic ballasts and starters, the latest generation has been powered by electronic ballasts or “low loss” ballasts since it became mandatory in the EU in 2010. High Performance T8 lamps with special phosphor mixtures were introduced as well as reduced-wattage versions or long life T8 lamps. Meanwhile an almost endless list of wattages for the different dimensions is available. The same is true for color temperatures and color rendering indices of the tubes to satisfy different applications. US and EU versions may vary slightly in their wattage and efficacy values. Products with a CRI of >80 have efficiency values from approximately 60 to 90 lm/W, while products with a CRI >90 vary between 50 and 80 lm/W. The efficiency of a good T8 ballast is approximately 90%, resulting in a system efficacy of 45 to 80 lm/W, not taking optical losses into account. There are mainly three differences between T8 and T5 lamp types:

- T8 lamps are designed for peak performance at 25°C, whereas T5 lamps show their maximum performance at 35°C
- T8 lamps may be driven with magnetic ballasts if complying with regulations, T5s require electronic high-frequency operation
- T8 lamps have a tube diameter of 1 inch while T5 lamps have a diameter of 5/8 inch

The first two points were discussed above, but the third point also has some consequences. The larger diameter makes optical design for some applications and requirements more complicated, which can result in lower optical efficiency (Light Output Ratio - LOR) or light distribution less accurate than desired.

Figure 3:
e:lumix CTO,
Mr. Thomas Zabel,
demonstrates the
driverless 150cm
replacement tube
prototype with
over 8,000 lm

Current State-of-the-Art in LED Replacement Tubes

The latest generation of T8 replacement lamps delivers efficiencies of 95 to 140 lm/W. In accordance with the T5 nomenclature, there are eco, HE and HO versions of tubes available. While the high efficiency versions of a 1200 mm long tube deliver about 2000 lm, the high output versions can deliver approximately 3000 lm at power ratings between 15 W and 30 W. Most products are rated with CRI 80+ and a lamp life between 30,000 and 50,000 hours. High CRI versions are very rare, but may be available on request. The prices of standard products range between approximately €30 for a 60 cm tube up to almost €200 for a 150 cm tube. As a result the costs are about 30 €/klm to 90 €/klm. The latest announcements are pointing to a cost reduction of 15-20 €/klm.

The difference between “high efficiency” and “high output” replacement tubes is mainly the number of LEDs and a lower power rating. The main efficiency advantage is based on reduced thermal stress and the resulting temperature related increase of efficacy.

Cost-competitiveness of T8 replacements

Two scenarios and two different lamp dimensions may help to clarify the question of if and when to replace T8 lamps with LED tubes.

The scenarios show that LED replacement tubes can compete with standard T8 solutions in regards to overall costs. To compete with long-life T8 lamps, 60 cm tubes have to have an efficiency of at least 95 lm/W while the 120 cm tubes have to exceed 105 lm/W at the given price.

Optical performance of T8 replacement lamps

Retrofit products are often marketed with the argument that one does not need the power of the original lamps because the light from the replacement product provides similar light levels. That may be true for some applications, but in many cases it is necessary to replace each individual light. When direct or indirect solutions are chosen by light planners they usually need to install a specific luminaire type. In these cases it is mandatory for a replacement product to mimic the light distribution of the original light source perfectly.

This means that there are at least two completely different situations:

- Replacement for luminaires with a light distribution angle of more than approximately 120°
- Replacement for luminaires with a light distribution angle of less than approximately 120°

In the first case, the optical performance is identical to that of the original lamp. A comparison is relatively simple.



In the second case, the properties of the replacement lamp may differ from the original product. Depending on the optical system, light distribution may vary slightly or be practically unnoticeable or it can vary dramatically and be unacceptable.

Advances during the past year made have it possible for replacement tubes to come close to the luminous flux of the original tubes. Increased efficiency and temperature stability allow for LEDs to be driven harder, to place more LEDs in the same area and to place them closer together. e:lumix, for instance, recently presented 120 cm T8 LED tubes with a nominal luminous flux of about 3,000 lm compared to 3,350 lm of the T8 lamp. The 150 cm T8 replacement prototype offers 8,000 lm and exceeds the T8 tubes by 50%.

Table 2:
Two scenarios to
compare overall
costs of LED
tubes, T8 long-life
and standard
tubes

	60 cm Tube			120 cm Tube		
	LED	T8 long-life	T8 standard	LED	T8 long-life	T8 standard
Lamp life (hrs)	50,000	75,000	20,000	50,000	75,000	20,000
Lamp costs (EUR)	30	15	3	40	15	3
Power rating (W)	15	18	18	31.9	36	36
Efficiency (lm/W)	95	75	75	105	93	93
Luminous Flux (lm)	1350	1350	1350	3350	3350	3350
Maintenance (base: 75,000 hours)	1.5	1	3.75	1.5	1	3.75
Maintenance costs per service (EUR)	20	20	20	20	20	20
Electricity costs per kWh (EUR)	0.15	0.15	0.15	0.15	0.15	0.15
Energy used (kWh)	1125	1350	1350	2393	2700	2700
Maintenance costs (EUR)	10	0	55	10	0	55
Electricity costs (EUR)	169	202.5	202.5	359	405	405
Overall lamp costs (EUR)	45	15	11	60	15	11
Overall costs for 75,000 hours (EUR)	215	218	267	429	420	471

Electrical performance of replacement tubes

While the drivers are integrated in these tubes, electrical losses must still be considered. Another relevant thought is that certification of the luminaire may be lost if changes are made. Therefore, for existing systems with magnetic ballasts, the starter is exchanged for a fuse and the fluorescent lamp is replaced by the LED tube. This means that the lost ballast is still a part of the electrical circuit and wastes a relevant amount of energy; up to 30%. Overall performance may be better than before, but in fact, a huge potential is unused. With lower figures of 10-15% additional losses, the same is true for newer systems with electronic ballasts. But here, another problem appears. Most replacement tubes cannot be operated with electronic ballasts.

In either case a professional is needed to bypass the original ballast in order to achieve optimal performance. The result of this is that UL or VDE certification will very likely be lost.

Safety issues of replacement tubes

Currently, there are no specific standards for LED replacement tubes. In general, though, they must meet the applicable specifications for a standard fluorescent tube. The most critical issue is probably the fact that

when one end of an LED tube is inserted into a luminaire, it causes a safety hazard because it is in direct contact with live parts, like contact pins and therefore it doesn't fulfill the safety objectives. This predicament causes restrictions when it comes to product design. In the end the only solutions that are taken into account are those that are compliant with safety requirements and don't affect safety certifications. Improved solutions are using single sided powered lamps only. In this case there are no safety issues any more.

There are additional aspects that are not directly covered by regulations and certifications. To reduce costs, sometimes the electronic design is not only minimized, but cheap components are used, and the necessary diligence during the manufacturing process or the final inspection is neglected. These unreliable components may cause critical hazards.

Latest T8 LED Replacement Lamp Technologies

Very different philosophies are behind the different products. T8 systems are used in various applications, from general lighting in corridors, basements or garages - where flicker is not an issue - to shops or offices where crucial work is done and electronic ballasts are used to substantially eliminate flicker. Replacement lamps are designed with the same broad range of parameters like flicker, CCT or CRI as the original system.

Besides that, lamp manufacturers can also follow different approaches regarding the number of LEDs, current and voltage levels.

Most tubes are assembled from a number of rigid LED strips; 2, 3, 4, 5 or 6 pieces for 60 cm to 180 cm tubes. Each strip may consist of one to three strings, usually powered in parallel and sometimes in series. Meanwhile, driver IC manufacturers provide solutions for any conceivable configuration.

Drivers

There are three remarkable main technical trends in electronics for fluorescent replacement lamps:

- Drivers and driver design that allow the use of one type of LED replacement tubes for both fluorescent systems with magnetic and electronic ballasts without the need to bypass the ballast
- Simplified non-isolated, highly efficient drivers that lower system costs
- Driverless (AC) solutions for a total cost optimization

The driver design has a big influence on the rest of the product design. The driver not only influences some of the parameters of light quality it also determines the physical properties of a replacement tube. The driver needs space in the tube, and there are only two ways to provide it.

The driver circuit can be placed on one or both ends of the lamp; in the socket(s). In this case the sockets need to be elongated which causes the length of the light emitting area to be reduced. With this solution, it is possible to produce tubes that emit light in a 360 degree angle like fluorescent tubes do.

The second solution is to mount the driver somewhere in the tube on the back surface of the PCB or in a cavity opposite the light emitting side. This makes it almost impossible to find an economically feasible solution for a 360 degree light emission angle. In fact, it is almost inevitable the design with a heat sink on one half and a diffusor on the other half of the tube, resulting in a typical 120° to 180° emission angle will be used.

The driverless solution overcomes the disadvantages of both of these solutions.

All-in-one replacement tubes

Simplified handling of the replacement tubes is a completely different approach. The solution complies with a maximum of original T8 ballasts. These drivers have to handle different kinds of input signals from 50/60 Hz

Figure 4:
LED assembly for
T8 replacement
lamps (e:lumix
production line)

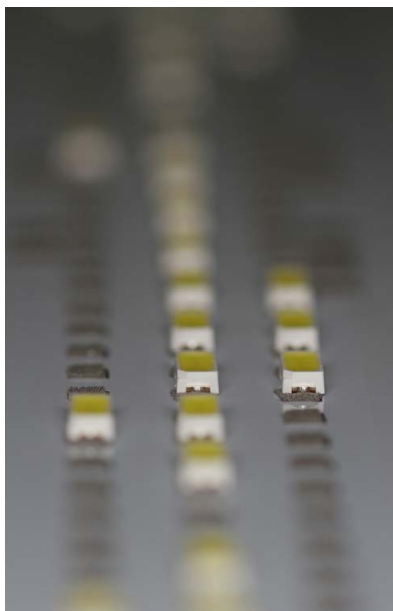

up to several kHz over a broad voltage range. Furthermore, they need to fulfill the safety requirements and to handle the different kinds of lamp ignition that is necessary for fluorescent lamps. This does not make for simple and cost effective electronics. Therefore these types of products are not very common.

Actually, LED professional is only familiar with one such product, the patented Schmelter IS series. Behind these features there is an interesting approach: The driver detects the input pins and the system performs the necessary actions to provide the required safety and to properly switch on and drive

the LEDs. Right at the moment when the current is detected on one pair of pins, the other pair is immediately switched off before becoming a danger if they are accidentally touched. After that, and during regular operation the driver immediately provides conditions that suppress the ignition of the starter as well as the startup mode of electronic ballasts. The ballast enters its standard operation mode and provides the LED driver with the required power.

Figure 5: Typical multi-stage LED driver with active PFC (top) compared to a typical T8 replacement driver solution, a single stage buck circuit with passive valley fill (center) and a CCR solution (bottom)

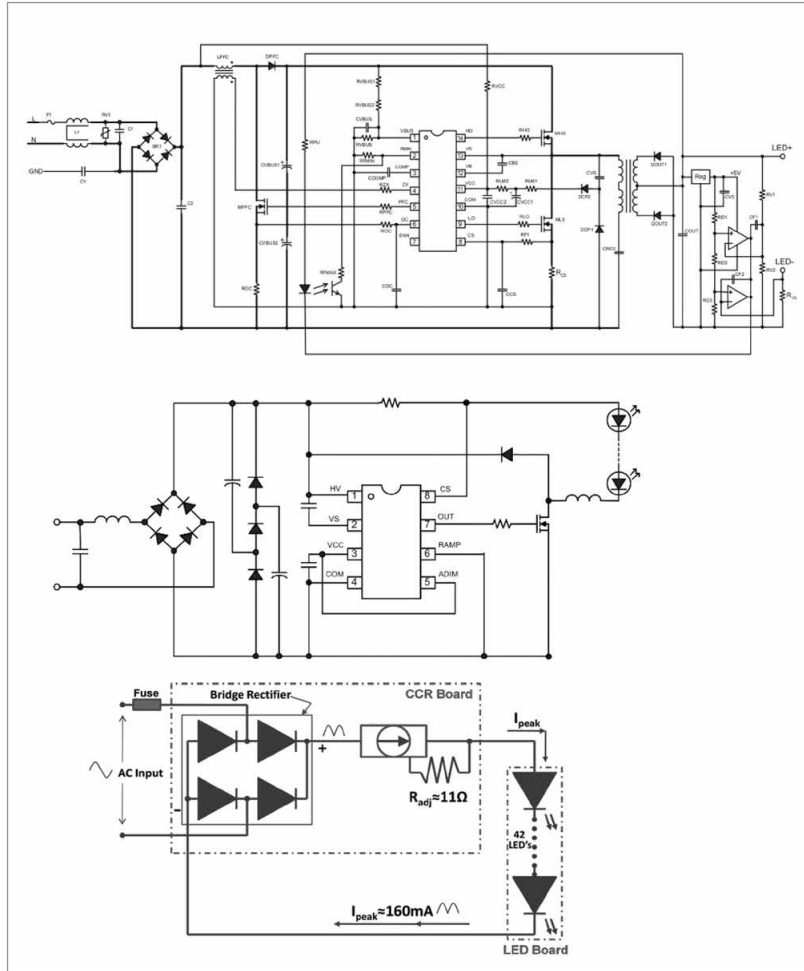
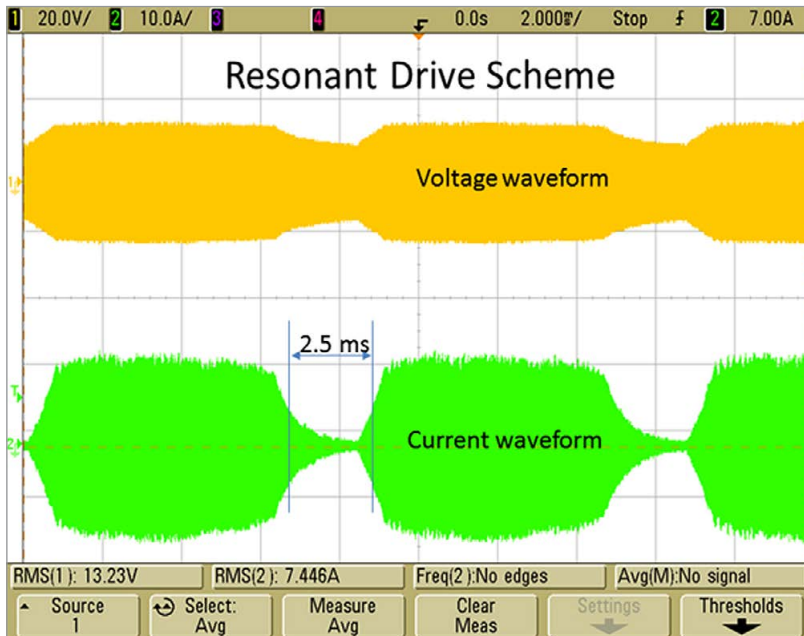

Figure 6: Resonant drive scheme that helps to virtually reduce flicker to zero



Simplified driver designs

Increasingly during the past year, numerous driver IC manufacturers presented drivers that are especially designed for fluorescent tube replacement solutions. What they all seem to have in common is a reduction of BOM and therefore costs. One way to reduce BOM is by using non-isolated drivers which also boost system efficiency and reduce the temperature of the driver board and components. These boards use approximately half the number of components of isolated designs and are typically 3 - 4% more efficient. Some IC manufacturers have already introduced driver ICs that are especially designed for applications like replacement tubes. Companies like Power Integration, International Rectifier, Integrated Silicon Solution or Texas Instruments offer drivers for simplified cost effective solutions and reference designs.

Driverless AC solutions

Another approach is demonstrated by ON Semiconductor with its constant current regulators (CCRs). This is, depending on how driverless is defined, a driverless aka AC LED solution. The advantage of the CCR solution versus a simple current limiting resistor is that it keeps the current stable over a certain voltage range. At the same time a simple resistor provides the desired current at a specified voltage. The main issue of the driverless approach is flicker; another is a considerably lower efficiency than DC systems. Both issues can be substantially eliminated. Current limiting

Figure 7:
Typical structure
of a replacement
tube

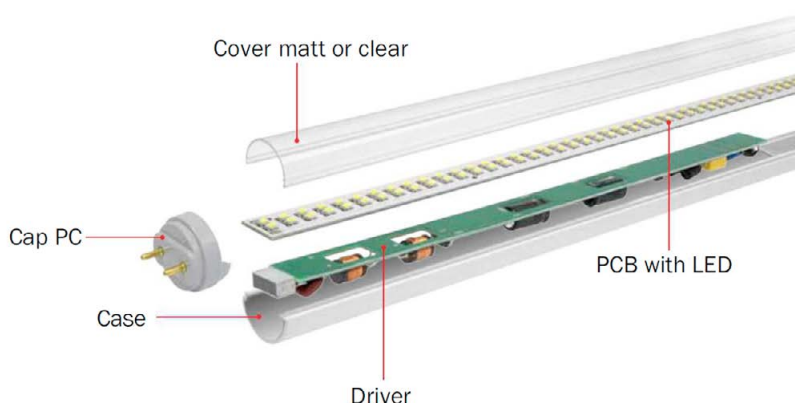

components can be used to cut off the LED's droop area, clearly improving efficiency on a level close to that of a DC driven LED. System efficacy may even exceed that of a driver based solution. A poorly designed driverless product flickers like a fluorescent tube on a magnetic ballast with 100/120 Hz respectively. But there is an opportunity to reduce that effect so far that it cannot be observed and some specialists also hold the opinion that the negative physiological effect of flicker is reduced to zero by these measures. In fact, it is necessary to reduce off time to below 2 milliseconds. In practice, reducing the pulse width of the dark period has an effect that is equivalent to increasing the modulation frequency. Furthermore, the 2 ms, the so-called optical gap, can be filled with stored energy. This can be achieved by using different approaches. The required energy can be provided from long latency phosphor or electrically stored energy. Both solutions are currently in development [1].

Optics

T8 replacement tubes usually have frosted or clear covers. The frosted ones provide a more homogeneous light emission and, in general, less glare, while the clear versions provide a somewhat better efficiency and overall luminous flux. Sometimes micro-structured covers are used. These solutions combine the best of two worlds; high optical efficiency, reduced glare and homogeneous light distribution. However, the optics is a little more expensive and may be more vulnerable to pollution.

Conclusions

T8 lamp replacement with LED tubes has to be considered carefully. A replacement lamp for a specific luminaire has to mimic the original as much as possible to achieve equivalent optical behaviors. The optical properties are often entirely different which can cause the light distribution of the system. For this reason the overall performance, and not just maximum illuminance, must be checked to make sure it stays the same. When doing so,

the weaknesses of an existing system will be mimicked too. In addition, the strengths of a new technology are usually sacrificed. Therefore luminaires especially dedicated to T8 replacement lamps should be developed as well.

LED tubes are now at a stage where they are not only beginning to become serious competition for T8 tubes, but are even outperforming them in some aspects. The only relevant issues that remain are the costs. In order to remain competitive in the area of price, simplified production technologies are sometimes used along with cheap electronic components and designs. Sometimes this results in the safety of the product being sacrificed due to overheating of the electronic components.

An LED replacement lamp is a complete system. It is more of a luminaire than of a light source. That is also true when we look at the price. Here the question arises if it is not the better solution to replace the luminaire completely.

Generally speaking, LED technology, starting in spotlight applications, is ready to overtake area lighting from the fluorescent lamp technology as well. LED technology offers high efficiency, dimmability, CCT controllability in complete full-packed units. The quality of replacement lamps is key and the application is relevant for the overall performance. LED technology will stop toxic products from being put on the market and into our environment. In the end, they will outperform the older technologies. ■

References:

- [1] LpS 2012 Proceedings Booklet – LED Lighting Technologies, Winning Approaches, page 20, AC-LED Technology – A Niche Product or the Future of LED Lighting, Bob Kottritsch, M.Sc., Lynk Labs Inc., ISBN 978-3-9503209-4-7

Digital Driver IC Chip Designs for Retrofit Bulbs

Ikon Semiconductors' CEO, Conor McAuliffe, talked with Siegfried Luger and Arno Grabher-Meyer from LED professional about Ikon's new digital design approach for digital LED driver ICs. Ikon Semiconductors was founded in 2009, by a very experienced team of semiconductor industry veterans. Ikon's first product, the IKS 2053, was optimized for LED lighting to deliver low cost, reduced size, high reliability and improved dimmer compatibility.

Figure 1: Block diagram of Ikon's IKS 2053 driver IC, with a digital core, analog peripheral system blocks. The IC is controlled by sophisticated software algorithms

LED professional: Can you tell us about the background of your development?

Mr. McAuliffe: You probably know better than we do how fast the LED lighting market is growing. Incandescent lamps have been around for well over a hundred years and now they are being phased out. Soon consumers won't be able to purchase the old products and will be obliged to purchase a low energy alternative. CFL technology is the most widely used low energy lighting technology today but it is being rapidly surpassed by LED lighting technology for many reasons. CFLs contain mercury, the quality of light is not good enough and they don't support dimmer compatibility. LED technology addresses all of those issues and as a direct result is the fastest growing low energy technology today.

LED professional: What problems do your customers emphasize when it comes to existing driver solutions?

Mr. McAuliffe: When we talk to our customers they highlight four main issues; I guess "pain points" is the right term: Cost, Size, Reliability and Dimmer compatibility.

Consumers want to buy a product that has the same socket size, has essentially the same shape and delivers the same performance as whatever incandescent light bulb they are replacing in their home.

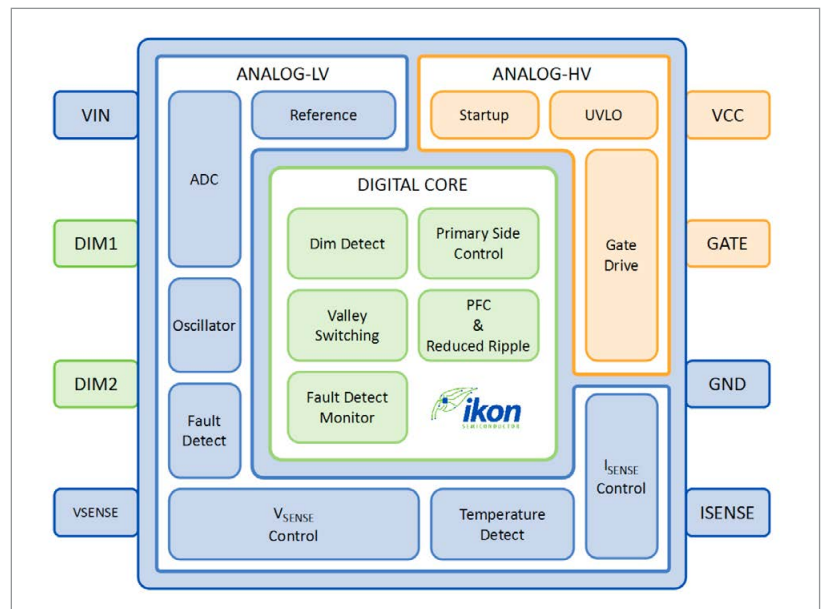

And that puts a lot of restrictions on the designers of LED light bulbs in terms of electronics, which must fit inside of the bulb – so clearly size is an issue. The number of components that go onto the PCB, and that obviously raises the issue of costs.

Consumers have read about the longevity of LED lighting technology. You will often see quoted 35,000 to 50,000 hours life-time for LED lighting. And certainly LEDs have the potential to last that long but the reality is that the electronics in many cases is the weak link in the chain in terms of reliability. And when you drill down into that issue in more detail, what you find is that certain components are most likely to fail before others. And two that are notorious are

electrolytic compositors and opto-couplers. So anything you can do to eliminate those components or reduce the number of those components is also highly desirable. And the approach we've taken is to address all of those four issues with our first product and based on our platform, digital technology.

LED professional: What about the needs of lighting designers?

Mr. McAuliffe: They are looking for a product that is affordable to their end customer, longer lasting, a product that is flicker-free and dimmer compatible with existing dimmers. Finally the bulb designers also want an easily integrated and easily designed product.

LED professional: This leads us to Ikon Semiconductor IKS 2053 which is the first embodiment of your proprietary technology. What are the key benefits?

Mr. McAuliffe: We reduced LED BOM costs by reducing the number of components that are required and therefore we could reduce the size. We also have a proprietary intelligent digital engine to support dimmer compatibility. So the overall solution delivers high performance in terms of power factor correction, efficiency and light output current regulation.

LED professional: Was the development of this first product done by Ikon alone or together with a strategic partner or customer?

Mr. McAuliffe: We developed it completely on our own. All the ICs are 100% Ikon ICs.

LED professional: How many patents resulted from this development?

Mr. McAuliffe: There are three or four that have been filed already with others in preparation. And we have a healthy pipeline of patents being pushed through the application process.

LED professional: Is it correct that Ikon only designs and doesn't manufacture?

Mr. McAuliffe: Yes, that's correct. We are a typical fabless company. We design and sell the chips but outsource the manufacturing to a foundry partner. All aspects of chip manufacturing, packaging and production tests are outsourced. It's a 100% standard fabless business model.

LED professional: Can you tell us which fabrication process you support?

Mr. McAuliffe: What I can tell you right now is that we are designing on a very low cost CMOS process. At this stage we can't go into details regarding the process or the fab itself.

LED professional: If we talk about BOM costs; which components could be eliminated with your digital design?

Mr. McAuliffe: We have eliminated the need for an opto-coupler and the high-voltage electrolytic capacitors. The user has an option for an electrolytic capacitor but that

also could be replaced with alternative capacitor technology, if desired. We also have a feature in our products that allows our customers to trade-off the power factor correction performance against the output ripple. So, if you don't need 0.95 power factor correction and 0.8 or 0.7 is sufficient, you can use that and trade-off by appropriate selection of an external resistor component.

LED professional: So, your design supports a single and a two-stage topology?

Mr. McAuliffe: No, our first product only supports a single-stage flyback. And that's really driven by the small size in the most space constrained light bulbs, particularly when you look at the lamps of GU 10 which are highly space constrained bulbs. So our first product was specifically developed as a single stage controller with an optimum combination of size, cost, reliability and dimmer compatibility. We are developing and will be announcing future products over time and that may also include 2-stage controllers.

LED professional: You said you can achieve a really high power factor without a 2-stage topology. What is the approach there?

Mr. McAuliffe: Inside our controller we have part of our digital engine which is an active PFC control function. But we have a feature designed into the IC that allows us to trade off part of the PFC versus the amount of output ripple.

LED professional: With this active integrated PFC you should also have advantages regarding efficiency, shouldn't you?

Mr. McAuliffe: Yes, what you'll find with a lot of PFC reference designs are valley-fill approaches. Various other circuits use additional stages: A first stage as a boost followed by a flyback stage. So efficiency of a single stage is going to be higher than a 2-stage solution.

LED professional: Other companies also claim to have digital controller IC's. What's really unique about your design?

Mr. McAuliffe: We are not the only company that is offering a digitally controlled driver technology. The key point of our product was built on what our customers

First Choice for Light

Approved IES LM-80 6,000-hour test

➤ Exhibition: GUANGZHOU INTERNATIONAL LIGHT EXHIBITION, 9-12 June, 2013, hall 10.2-C02 Pazhou Complex, Area B, Guangzhou

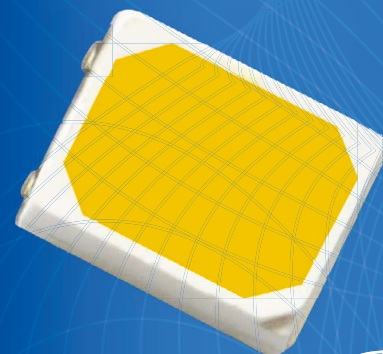

2835

LM-80

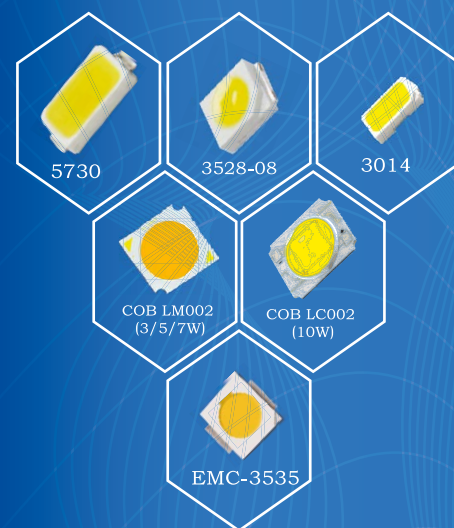

Guangzhou Hongli Opto-Electronic Co., Ltd.

Address: Airport High-Tech Industrial Zone, Jingu South Road (Intersection of Xianke 1st Rd), Huadong Town, Huadu Dist., Guangzhou, China

Tel: +86-20-8673 3333 ext 3033

Fax: +86-20-8673 3883

E-mail: sales@honglitrionic.com

www.honglitrionic.com

Become our distributor, your right choice.



HONGLITRONIC
鸿利光电

The Leading Manufacturer of White Light LED in China.

Figure 2:
Ikon has an evaluation board available that is based on their IKS2053 technology

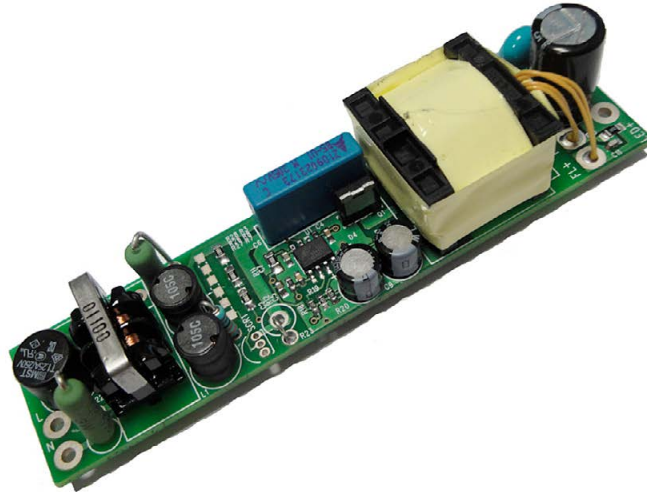

told us they need. Our conclusion that the best way to meet those needs was with true digital control and the flexibility that true digital control offers. The overall AC to DC conversion market is moving into the digital direction.

It's the algorithm and the mathematics that makes it unique. If you can imagine an algorithm or come up with an algorithm it is relatively easy to map that to digital but it's more complex to try to map complex algorithms into analogue circuits. And really, once you make the transition away from analogue and the restrictions of analogue into the digital domain it's performance of the algorithms are only restricted by your imagination.

LED professional: Is your IC based on a micro-controller or micro-processor core?

Mr. McAuliffe: It's closer to the latter than the former. We would describe it as a modular architecture. So it is really built up from a number of component-building blocks. There is certainly a degree of configurability in those building blocks or modules.

LED professional: But will a designer have the opportunity to change or modify parts or the configuration within the IC or can the design only be made outside with components?

Mr. McAuliffe: Currently, with the products that we are offering, the customer won't have the ability to

access the internal digital engine or won't have the ability to configure or programme it. That is essentially done with the external components, but obviously, a key part of the whole product offering is around the area of support, and we support our customers in terms of developing reference designs. We also support them in terms of offering a service to our customers whereby we will customize the IC if they desire. But initially, the focus has been to, essentially, from a black box point of view, make this controller look like the inferior analogue products that we're replacing. That doesn't preclude in the future, products where users will have access to the digital core.

LED professional: What frequency does your system operate on and what other features does it have?

Mr. McAuliffe: Switching frequency on the IKS 2053 is a little over a hundred kilohertz. At the heart of the product we have the modular digital core. The intelligence, algorithms, the mathematics is implemented in the digital core and around that we have the analogue shell of support circuits. Things like start-up, under-voltage lock-out, gate drivers, temperature detection function for over temperature protection are built-in features.

LED professional: Your IC 2053 is optimized for phase-cutting dimmers. What about digital control? Lighting systems today are also tending to go digital. Do you see a digital interface with the environment?

Mr. McAuliffe: On the issue of dimmer compatibility, the first product has been optimized for the residential bulb replacement market. So we've designed dimmer compatibility from the point of view of the installed legacy dimmer base that people have in their homes. And we've designed it to be compatible with the broadest range of dimmers. So that includes leading edge triac dimmers, falling edge electronic dimmers and we've put a lot of effort into looking at the types of dimmers that are out there. Just to give you some interesting numbers: From our own work here, we have identified well over 70 different dimmer manufacturers and over 500 dimmer models that are in use in the residential dimmer market. And we have put a lot of effort into selecting a large number of those to be representative of what is out there in the market and ensuring that our product is compatible with those dimmers.

Now if I understand you correctly you may also be referring to some activity in the area of new dimmer technology such as power-line communications.

LED professional: Exactly.

Mr. McAuliffe: We currently don't support that particular technology. It's certainly not a technology that is in wide use. As I said, we focus on the dimmer technology that is in wide use - already out there in hundreds of millions of sockets around the world today. But we are keeping a very close watch on those other activities. And certainly, if and when that technology gets a foothold in the market, it would certainly be something that we would be looking to support.

LED professional: What about the minimum load problem? Usually, with most drive dimmers you should have a minimum load.

Mr. McAuliffe: That's correct, and that's typically why bleeding circuits are required to support dimmer compatibility. To ensure that you have that minimum load is important. That's one of the reasons why we've included support for active bleeding as well as



Conor McAuliffe

Conor McAuliffe has been involved in the semiconductor industry for over 25 years. During this time he has taken on a number of senior design and management roles in both tier-1 and start-up semiconductor companies. This has included positions as a design engineer with Analog Devices and as Technical director for Mixed Signal with Parthus Technologies, which floated on the NASDAQ and LSE in 2000.

In 2003 Conor co-founded Silansys Technologies, a mixed signal design company, where he served as CTO.

In January 2009 Mr. McAuliffe founded Ikon Semiconductor to develop integrated solutions for the rapidly growing LED lighting market.

active damping. And it allows you to provide the bleed current in a more efficient way than if you have a passive bleeding circuit whereby the bleed circuit would be continuously running. So there are some tricks you can play there in terms of providing that bleed current to keep the dimmer operating but doing it in a more efficient manner.

LED professional: You are focusing on replacement bulbs with your design – but there are other replacement lamps like tubular lamps. How can you use your IC for other applications apart from bulbs?

Mr. McAuliffe: The IC is certainly applicable to those other applications. Fluorescent tube replacement is another area that we are looking at. Our first reference designs have been optimized for bulb replacements like GU10s and A19s but we are also looking very closely at the tube replacements and the technology is very well suited to that market as well.

LED professional: Is there a power limitation?

Mr. McAuliffe: Our IC is designed to drive an external power MOSFET so that gives us quite a degree of flexibility in terms of the power range over which it would be suitable for. But certainly for any form of bulb replacement product well up to 15 – 20 watts we would be very comfortable in that range. Right down to down to the very low powers of 2 and 3 watts as well.

LED professional: Was that the reason you decided to have an external MOSFET? Nowadays the MOSFET is often integrated into the driver IC in order to save space on the board.

Mr. McAuliffe: I would very much view that as a road map issue. Our technology is capable of working with an integrated power MOSFET or an external one. And even in the case where the power MOSFET is integrated you have two choices. It can be a single-chip solution on a high voltage 700 volt process or it could be a two-chip solution for the controller with an optimum small

geometry process, and for the power MOSFET with a larger geometry higher voltage process. But again, I would view that very much as just a road map issue and the decision to roll out those products will be driven largely by feedback from our customers. But we have lots of choices there, external power MOSFET, integrated MOSFET, external BJT, internal BJT. And they are certainly all a part of our long term product road map.

LED professional: This IC is really focussed on replacement bulbs. In three to four years the number of replacement bulbs will decline and the higher volumes will be dedicated to luminaires with LED modules. Is it on your roadmap to change from replacement ICs to ICs for modules and luminaires?

Mr. McAuliffe: Absolutely. You are absolutely correct in what you just described. We're going through a process now; a transition process whereby the incumbent technology has been legislated out and consumers are obliged to purchase these products that are very much restricted because they have this legacy issue where they must be backward compatible with the technology that they're replacing. But over time, I think that LED technology has a lot more potential in terms of the type and quality of light in products that you can develop with LED technology. And in fact, you even have OLED technology which is beginning to get a foothold in the market. And that's likely to enable some very interesting lighting form factors. So certainly over time, particularly in new buildings as opposed to existing residences where people are very much limited by the retrofit issue, we would expect to see that change a lot. I would see the LED bulb retrofit market as being a transition market as we move into more interesting and more innovative lighting products.

LED professional: Congratulations on this very sophisticated design and your time.

Mr. McAuliffe: Thank you. ■

New Optical Lithography Method for Advanced Light Extraction in LEDs

Objective material selection for various target applications is key for successful product development. Efficient light extraction features are crucial for highly efficient LEDs. Thomas Uhrmann and Harun Solak, et.al* from EV Group and Eulitha AG will demonstrate a novel lithography method, PHABLE™, that enables the printing of sub- μm patterns in a non-contact, proximity process.

The development of solid state light sources revolutionized our world in many ways. Solid state lighting for thin form factor flat panels implemented in TVs and mobile and automotive applications is just the best visible example. Working on feasibility of solid state light sources in the pioneering years, followed by gains in reliability and yield, today's focus is on improving power efficiency and manufacturing cost. Efficiency is still a big factor when it comes to competitive cost structures for meeting customer demands. LED manufacturers that increase the optical power output per substrate area have real advantages on the market. Although the problem of light extraction was solved decades ago, physics shows otherwise. The major obstacle for efficient light extraction from an LED is the refractive index mismatch between the LED chip and the surrounding environment. This difference restricts the light escape cone to only 24° . As a result, only a little of the generated light can escape the LED, while the biggest portion is kept in the substrate by total internal reflection which is reabsorbed in the end. Furthermore, the interface

between the light generating semiconductor and the sapphire substrate affect light extraction. Since prompt extraction of photons is key for high overall efficiency solutions both interfaces have to be optimized for best light management. Due to large emission angles and broad spectral bandwidths three-dimensional, sub-resolution patterns that smooth the refractive index step have proven to considerably enhance light extraction.

Introduction into Efficient Light Extraction Basics

Patterned sapphire substrates

The cornerstone for efficient light extraction is already set by structuring the bare sapphire substrate surface. Patterned sapphire substrates (PSS) are dominantly used for lateral LEDs, where the sapphire remains as part of the final device. Two advantages can be observed with using PSS instead of flat sapphire wafers. First, the pyramidal PSS features effectively reduce the refractive index contrast; hence they reduce total inner reflection of light [1]. Second, the internal quantum efficiency is increased by more perfect epilayers due to reduced dislocation density [2].

These days, PSS feature sizes range from 1-3 μm . Further shrinking of PSS to the submicron scale, so-called nano-patterned sapphire substrates (NPSS), increases light extraction efficiency and growth perfection [3]. Likewise, throughput for etching and epitaxial growth is increased, due to reduced etching depth and layer thickness. For either process the resist patterning step quality is essential for the final PSS feature size, shape and overall performance.

Surface extraction features and photonic crystals

While PSS is mostly applied for lateral LEDs, surface extraction features can be applied to all LED chip designs. One of the most effective technologies for enhanced surface light extraction is patterning and etching of regular structures into the LED surface. Such structures range in size from a couple of micrometers down to some hundred nanometers, depending on the manufacturing technique. To etch micro-pillars into the LEDs' surface is a typical solution. Pillars with straight sidewalls already add to the extraction efficiency. However, tapered sidewalls allow harvesting the majority of the radiation generated in an LED [4]. Alternatively more complex photonic crystal structures increases light extraction. On top of this it facilitates control of the light directionality.

We bring quality to light.



Putting LEDs in the right light.

SSL solutions from the world leader in LED measurement



Instrument Systems set the benchmark in LED testing with high-performance spectroradiometers for photometric and colorimetric measurements. Now we present another breakthrough in Solid-State Lighting with our new goniophotometers and integrating spheres.

Find out more about our innovations for SSL:
www.instrumentsystems.com/ssl

 **Instrument
Systems**
light measurement

Figure 1:
Simulated image produced by a linear diffraction grating illuminated by monochromatic collimated light (a).
Simulated image of time integrated intensity (exposed field) obtained with the novel axial-shift exposure showing the invariance along the longitudinal direction and complete elimination of the “depth of focus” limitation faced in conventional photolithography (b)

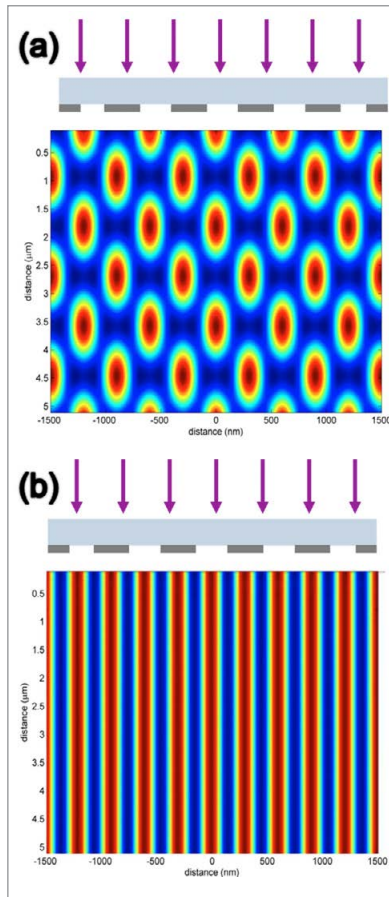

Periodic patterning solutions

Both interface patterning approaches mentioned above demand large area patterning with regular features. Feature sizes are typically restricted to $3\ \mu\text{m}$ for larger PSS features, but can range down to about $300\ \text{nm}$ for photonic crystal structures. Managing such a wide span of feature sizes with photolithography is not insignificant in a cost-conscious environment. Sequential e-beam lithography as well as deep UV lithography are prohibitive for any compound semiconductor application due to their low speed/capital expenditure ratio.

For PHABLE™, an optical solution that operates within the common wavelength range of approximately $365\ \text{nm}$, these restrictions do not apply anymore. This novel patterning technology enables the printing of features sizes in a non-contact, proximity process. Using a diffractive approach allows regular, sub- μm patterns as small as $200\ \text{nm}$ to be printed with a tool similar to a proximity mask aligner.

Advanced Photonic Patterning

The new technology overcomes the conventional limits that are known from standard optical mask aligners. Standard mask aligners generally run into the issue that the resolution is limited to about $3.0\ \mu\text{m}$ for proximity configuration. This means the photomask is placed in the vicinity of the wafer forming a $20\text{--}100\ \mu\text{m}$ separation gap during exposure. This resolution simply does not meet the requirements for PSS and nPSS. However, PHABLE, which is built on standard, cost and throughput optimized mask aligner technology, permits printing of such small feature sizes. It's unique property is the down to $150\ \text{nm}$ printing resolution for regular patterns in a single exposure step. Nonetheless, a mask-substrate separation gap of several tens of microns is kept while the image depth can be extended to cover the multiple micron thick resist without resolution deterioration. This very high aerial image aspect ratio allows printing of the same high-resolution patterns onto large and highly warped surfaces, such as LED wafers.

The PHABLE principle

PHABLE is based on the diffractive self-imaging of periodic structures, also known as the Talbot effect. The diffraction at an array of unit cells is followed by constructive interference that directly generates images - without an additional optical element. In short, periodic structures on a photo mask which are illuminated with monochromatic collimated light will generate images of the pattern at periodic distances, as depicted in Figure 1(a). It can be easily seen, that such intensity maxima within this Talbot-carpet have very short depth of the aerial image, which is quite similar to depth of focus in projection imaging (DOF), although in Talbot imaging there is no beam, but a continuous field. A typical 'DOF' value for a pattern period of $400\ \text{nm}$, illuminated with $365\ \text{nm}$ light, is $50\ \text{nm}$ [5]. Indeed, such a small DOF is not useable for any patterning application. This value is so small that it would completely prevent use of non-flat substrates and

photoresists with a thickness sufficient for manufacturing. Demands on positioning, flatness and alignment across the whole wafer with respect to the mask would be enormous across typical substrate sizes.

The new technology lifts this restriction. The breakthrough innovation, opening up industrial applications for the Talbot effect, lies in the dynamic exposure process. Here the wafer is not kept stationary at a single self-image plane, but it is moved axially by a full Talbot period of $p^2/2\lambda$, where p is the pattern period and λ is the wavelength, such that the vertical stripes induced here exactly intersects with each other. Due to the motion the intensity distribution is integrated. The result is an integral intensity, where a constant intensity map is present below the photomask, as shown in figure 1(b).

This image keeps its periodicity along the lateral direction but, interestingly, is not sensitive to the starting distance of the wafer from the mask any more. Therefore, the image has effectively no DOF limitation. A further advantage is that the printed in the photoresist pattern has half the period or twice the frequency of the grating in the mask. Therefore a resolution gain is achieved with respect to the mask.

Photolithography infrastructure

As PHABLE is based on standard optical lithography operating at the same wavelength range, standard optical resists can be used. To ensure reliable and reproducible lithography the used photoresist has to be set to meet some requirements. Primarily the contrast of the resist needs to be high enough. As PHABLE is a diffraction technique, the diffraction under the mask replicates the mask pattern at different distances from the mask. In these Talbot planes, intensity between maxima and minima varies continuously. Therefore, like with other high resolution applications, the contrast of the resist has to be high enough, so that the non-linear response of a photoresist converts the image into the intended binary pattern. Looking more closely at the intensity plot as shown in Figure 1b,

Figure 2: Schematics of the feature size correlation between mask structures (left) and resulting print images on the wafer (right) for lines (top), square arrays (middle) and hexagonal arrays (bottom)

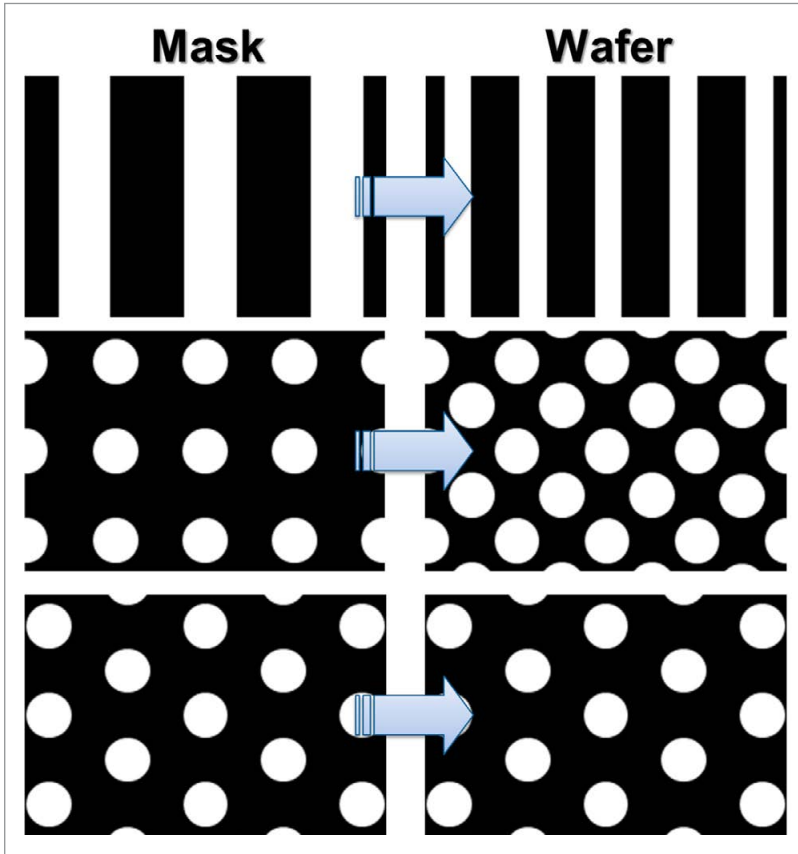

this calculation reveals a peak-to-valley intensity ratio of about three, which is a comfortable contrast window for high quality resist exposure. Extensive evaluation of different patterns and sizes has been undertaken and will be discussed in the following section.

Structures and sizes

Since PHABLE is a mask-based photolithography method, printing a different pattern simply requires a change of the mask. Full wafer, single exposure printing of features in the range of 200 nm to about 2.5 μm is possible. The limiting resolution of the printed features depends on the wavelength of the light used, with the smallest period being close to half the wavelength.

Both, one-dimensional patterns, such as lines and spaces, and two-dimensional patterns, such as hexagonal or square lattices can be produced. Examples of patterns printed

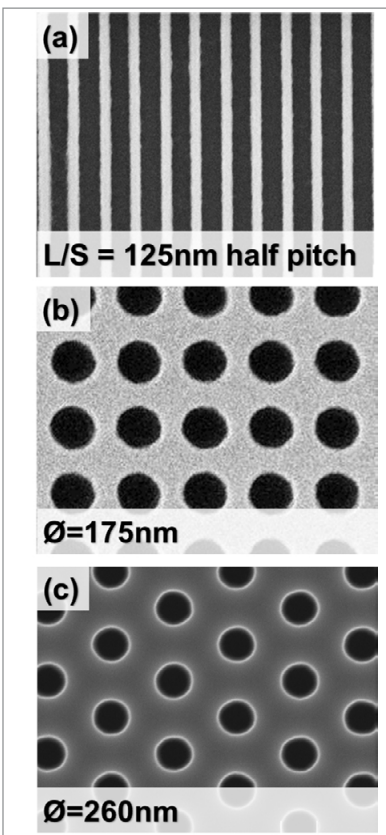

Figure 3: SEM images of photonic patterns printed with PHABLE: lines and spaces with 125 nm half pitch (a), square array with a hole diameter of 175 nm (b) and 250 nm pitch and (c) hexagonal array with a hole diameter of 260 nm (c)

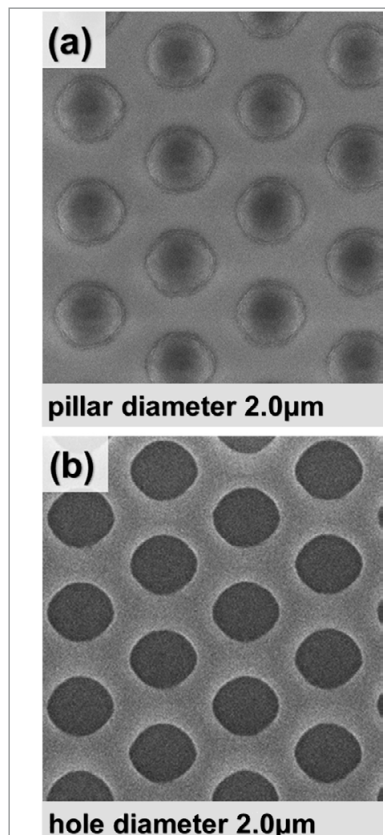

Figure 4: SEM images of resist pillars for patterned sapphire substrates. Pillar sizes of 2.0 μm (a) as well as holes (b) of the same sizes can be replicated with the same mask, by changing the resist type from positive to negative exposure type

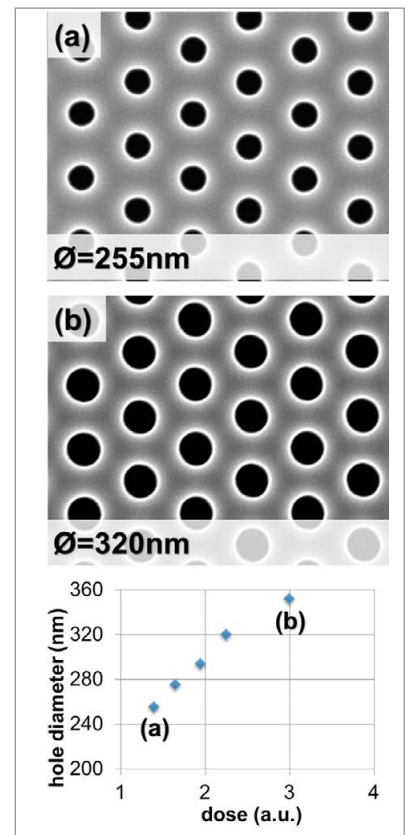

Figure 5: SEM images of substrate patterned by using the same mask but varying exposure dose. The relation between exposure dose and hole diameter is tunable over a wide range, resulting in a wide process control

using this method are shown in figure 2. The mask features are shown on the left, while the printed resist images are presented on the right. One advantage that can be seen is the demagnification ability for some cases. Taking a closer look at the lines and spaces on the top, the demagnification has a factor of 2. In the case of a square lattice, a feature in the center of the square lattice is printed simultaneously, giving printed image which has a demagnification of $\sqrt{2}:1$ and a rotation of 45° . In case of a hexagonal lattice, the periodicity of the patterns on the mask and the wafer are equal. This factor of demagnification is an inherent property of the diffraction nature of this process.

After taking a detailed look at the printing properties, the discussed printing capabilities are demonstrated. Figure 3 gives a selection of printed nano-patterns, marking the lower end of the printing resolution for lines and space, square and hexagonal arrays at the given parameters. Evaluation of the printed structures showed that good uniformity and reproducibility were obtained despite an uneven gap and large resist thickness, proving that the pattern is indeed insensitive to the distance between mask and wafer.

Sub-resolution nano-scale patterns receive wide interest for all kinds of photonic applications. Nevertheless,

larger micrometer-scale structures are also frequently demanded. For PSS the features are in the range of $2 \mu\text{m}$. Just the same as nPSS, PSS structures have been replicated (Figure 4).

Process variability and control

Pattern size in photonics varies in a wide range and precise control is important. In contrast to other patterning technologies PHABLE offers a broad window of pattern size control. On the one hand, resist pattern height adjustment is straight forward. Due to the ideal two-dimensional exposure region it is independent of the lithography process and simply controlled by resist thickness. Standard i-line and broad band resists are well established in semiconductor fabs and their coating performance and thickness are optimized. On the other hand, PHABLE has a unique property to control lateral feature dimensions. Just by changing the exposure dose, feature sizes can be tailored within a wide range, as shown in figure 5. The exposure integration through sample movement, does not influence sidewall shape or angle of the via openings in resist and resist pillars. In short, the same mask for hexagonal pillar sizes of 250 nm can also produce 350 nm pillars. Further control of the printed pattern can be obtained by optimization of the mask pattern and illumination field

distribution, to produce more delicate features than circles in the unit cell of the image. In addition, the large gap between the mask and the wafer avoids contact and damage and contamination and ensures an extremely long lifetime for the masks. This directly transfers into a clear cost advantage compared to other technologies.

Conclusion and Outlook

Printing of photonic structures is one of the key features for PHABLE. LED wafers have some extreme properties, such as high bow, warp and high surface defect density. Photonic nanostructures can be created on LED surfaces after epitaxial deposition steps or on sapphire substrates before the device layers are grown.

This new technology is ideally suited for patterning either structure. In particular, its non-contact nature and ability to print across large topographical features including uneven surfaces are highlights. Furthermore, a very wide range of feature sizes can be printed with the same tool. This does not only apply to different masks, but many different patterns can even be simultaneously printed on a single chip or wafer, making it a highly versatile and flexible tool for current and future production needs. ■

Full List of Authors:

* Thomas Uhrman, Alois Malzer, Alberto Montaigne Ramil, Boris Považay, Roman Holly, Thorsten Matthias, Markus Wimplinger, Paul Lindner, EV Group; Harun H. Solak, Christian Dais, Francis Clube, Peter Caioli, Eulitha AG

References:

- [1] J.J. Chen, et. al., "Enhanced Output Power of GaN-Based LEDs With Nano-Patterned Sapphire Substrates", IEEE Electronics Technology Letters, Vol. 20, p.1195 (2008)
- [2] Y.-K. Ee, et. al., "Metalorganic Vapor Phase Epitaxy of III-Nitride Light-Emitting Diodes on Nanopatterned AGOG Sapphire Substrate by Abbreviated Growth Mode", IEEE Journal of Selected Topics in Quantum Electronics, Vol. 15, p.1066 (2009)
- [3] Y.-K. Ee, et. al., "Abbreviated MOVPE nucleation of III-nitride light-emitting diodes on nano-patterned sapphire", Journal of Crystal Growth, Vol. 312, p.1311 (2010)
- [4] M. Ma, et. al., "Strong light-extraction enhancement in GaInN light-emitting diodes patterned with TiO₂ micro-pillars with tapered sidewalls", Applied Physics Letters, Vol. 101, p.141105 (2012)
- [5] H. Solak, C. Dais, F. Clube, "Displacement Talbot lithography: a new method for high-resolution patterning of large areas", Optics Express, Vol. 19, p.10686 (2011)



Signcomplex

We bring innovation and give impression



UL Approved

4" 5" 6" 7" 8" Downlights



www.signcomplex.com
marketing@signcomplex.com
phone: +86 755 2760 8650
fax: +86 755 2760 8651

Thermal Management for LEDs Beyond Thermal Conductivity Values

Specifically designed and formulated chemical products are widely used in the electronics industry for a vast array of applications. Jade Bridges, European Technical Support Specialist at Electrolube explains why such products have become an essential factor in ensuring the performance and quality of electronic devices, whether it is during PCB manufacture or for the protection of components or complete devices.

The subject of this paper is to discuss the application of these formulated chemical products for thermal management applications, specifically within the rapidly expanding LED industry. As we are all aware, LEDs have been present in many electronic devices for a number of years. More recent developments in this industry have led to their vast number of uses in all types of lighting, signage and domestic appliance products, to name but a few. In offering alternatives to halogen, incandescent and fluorescent lighting systems for both interior and exterior applications, the possibilities for LEDs are seemingly endless. LEDs offer advantages over traditional lighting forms in terms of adaptability - allowing more design freedom due to the reduced space required and exceptionally long life time - resulting in a cost effective solution for many applications. They are also considerably more efficient, converting the majority of energy to light and thus minimizing the heat given off.

Although LEDs are considerably more efficient than traditional lighting forms, they do still produce some heat. This heat can have an adverse effect on the LED and therefore must be managed to ensure the true benefits of this technology are realized. Typically categorized by color temperature, LEDs are available in a huge number of color variants. With a change in operating temperature of the LED, a change will also occur to the color temperature; for example, with white light an increase in temperature could lead to a 'warmer' color being emitted from the LED. In addition, if a variance in die temperatures is present across LEDs in the same array, a range of

color temperatures may be emitted, thus affecting the quality and cosmetic appearance of the device.

Maintaining the correct die temperature of the LED can not only extend the life but also lead to more light being produced and therefore, fewer LEDs may be required to achieve the desired effect. Therefore, an increase in operating temperature can have a recoverable effect on the properties of the LED, however if excessive junction temperatures are reached, particularly above the maximum operating temperature of the LED (120-150°C), a non-recoverable effect could occur, leading to complete

Figure 1: Thermal interface materials are crucial for the reliability of electronic products for different applications

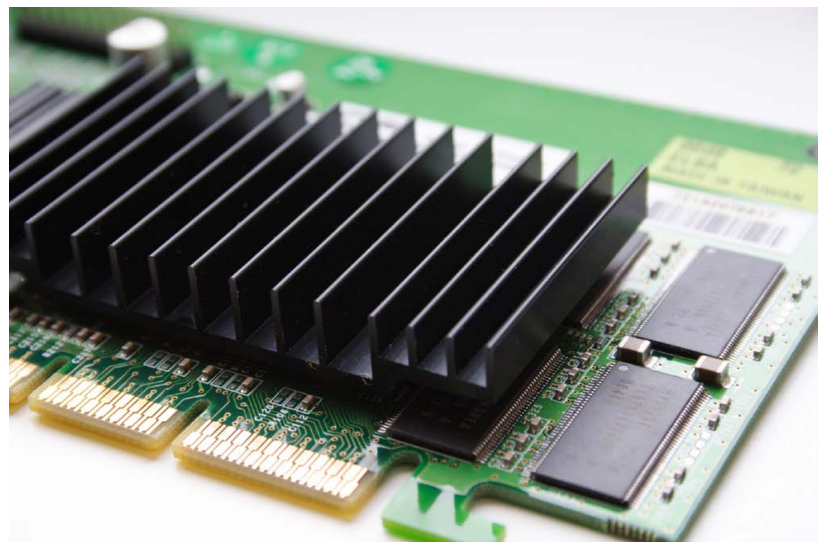

failure. Operating temperature is directly related to the lifetime of the LED; the higher the temperature, the shorter the LED life. Ensuring efficient thermal management is employed will therefore provide consistent quality, appearance and lifetime of LED arrays and in turn, opens up the opportunity for further applications for this ever evolving industry.

$$q = -kA(\Delta T/s) \quad \text{Fourier's Law of heat conduction}$$

q is the heat transferred through conduction (W)

k is the thermal conductivity (W/mK)

A is the cross sectional area of the material through which the heat flows (m^2)

ΔT is the temperature difference across the material ($^{\circ}C$ or K)

s is the material thickness (m)

The principles of thermal transfer can be discussed in detail, however, for the purpose of this paper, we shall briefly address the basics; conduction (heat transferred through a solid mass via direct contact – Fourier's Law), convection (transfer of heat through the movement of fluids and gases – Newton's Law) and radiation (the heat transferred through an electromagnetic field). Radiation typically only has a very small effect on the heat transfer of LED systems since the surface areas are relatively small and so it is the principles of conduction and convection that we are most interested in here: Conduction refers to the transfer of heat at the LED junction, between the LED and the heat sink, whereas convection refers to the transfer of heat from the heat sink to the surrounding air.

$$q = hA\Delta T \quad \text{Newton's Law of Cooling - Convection}$$

q is the heat transferred through convection (W)

h is the heat transfer coefficient (W/m^2K)

A is the surface area (m^2)

ΔT is the temperature difference typically between the surface temperature and ambient air ($^{\circ}C$ or K)

Newton's law of cooling states that the rate of loss of heat is proportional to the temperature difference between the body and its surroundings. Therefore, as the temperature of a component increases and reaches its equilibrium temperature, the rate of heat loss per second will equate to the heat produced per second within the component. Since heat is lost from a component to its surroundings at its surface, the rate of dissipation will increase with surface area. This is where heat sinks are used - varying in size and shape, heat sinks can be designed to offer a significantly increased surface area to maximize heat dissipation. Heat sinks are often used in LED applications and fix onto the back of the component. Ideally, these mating surfaces should be perfectly smooth, enhancing the efficiency of heat conduction, but this is not usually possible. As a result, air gaps will be present at the interface of the device and the heat-sink, significantly reducing the efficiency of heat transfer.

There are many ways to improve upon the thermal management of LED products. Therefore, the correct type of thermally conductive material must be chosen in order to ensure the desired results for heat dissipation are achieved. So, the first types of thermal management product we shall discuss are thermal interface materials, such as a heat transfer compound, to remove any air gaps present between mating surfaces and improving the efficiency of heat conduction at the



Touch the technology

GL SPECTIS 1.0 touch
Introducing world's first smart spectrometer.

If you need to measure:

- **Lux** – illumination value
- **Lumen** – the luminous flux
- **CRI** – color rendering index according to CIE
- **CCT** – correlated color temperature according to CIE standard
- **COLOR** – color coordinates according to CIE 1931 and CIE 1964
- **mWatt** – radiant power value.



www.gloptic.com



Light measurement solutions

LED junction. Such compounds are designed to fill the gap between the device and the heat sink and thus reduce the thermal resistance at the boundary between the two. This leads to faster heat loss and a lower operating temperature for the device. Curing products can also be used as bonding materials; examples include silicone RTVs or epoxy compounds – the choice will often depend on the bond strength or operating temperature range required. Solid materials such as gap filling pads and phase changing materials are also a possibility, where a thin film substrate is used at the interface. Therefore, an initial consideration in product selection is whether a curing product is required to help bond the heat sink in place, or whether a non-curing thermal interface material is more appropriate to allow for rework.

Silicone and silicone-free non-curing products are also available; the silicone products offer a higher upper temperature limit of $200^{\circ}C$ and a lower viscosity system, due to the silicone base oil used. This leads us to our next detail in product selection as the use of products based on, or containing, silicone may not be authorized in certain applications. This could be due to a number of factors, including application requirements or where problems exhibited in cleaning or adhesive processes are observed. Such issues are due to the migration of low molecular weight siloxanes; these volatile species can lower the surface tension of a substrate, making them extremely difficult to clean or adhere to. In addition, due to their insulative nature, migration of low molecular weight, siloxanes can lead to failures in electronic applications. Thus, silicone containing products should only be utilized where the low molecular weight fractions are monitored and kept to an absolute minimum. As an alternative, a range of non-silicone products are also provided for critical applications.

Another option for managing the transfer of heat away from electronic devices is to utilize a thermally conductive encapsulation resin. These products are designed to offer protection of the unit from environmental attack whilst also allowing heat generated within the device to be dissipated to its surroundings. In this case, the encapsulation resin becomes the heat sink and conducts thermal energy away from the device. Such products can be used to encapsulate the technology behind and attached to the LED device

and can also assist with the reflection of light back from within the unit, depending on the color chosen. Encapsulation resins also incorporate the use of thermally conductive fillers. However, the base resin, hardener and other additives used can be altered to provide a wide range of options, including epoxy, polyurethane and silicone chemistries.

The different chemistry options will provide a range of properties and each should be considered depending on the end application requirements. For example, a polyurethane material offers excellent flexibility, particularly at low temperatures; a major advantage over an epoxy system. A silicone resin can also match this flexibility at low temperatures as well as offering superior high temperature performance, well in excess of the other chemistries available. The silicone products are also typically more expensive. Epoxy systems are very tough and offer excellent protection in a variety of harsh environments. They are rigid materials with low coefficients of thermal expansion and in some cases a degree of flexibility can be formulated into the product. The formulation of encapsulation resins can lead to a vast array of products with tailored properties for individual applications and therefore it is advised that applications are discussed in detail with a relevant material supplier.

Regardless of the type of thermal management product chosen, there are a number of key properties that must also be considered. These can be quite simple parameters, such as the operating temperatures of the device, the electrical requirements or any processing constraints - viscosity, cure time, etc. Other parameters are more critical to the device and a value alone may not

be sufficient to specify the correct product. Thermal conductivity is a primary example of this. Measured in W/mK, thermal conductivity represents a materials' ability to conduct heat. Bulk thermal conductivity values, found on most product datasheets, give a good indication of the level of heat transfer expected, allowing for comparison between different materials. Relying on bulk thermal conductivity values alone will not necessarily result in the most efficient heat transfer.

$$\Theta = L/k A$$

Thermal Resistance
of the Interface Material

- Θ is the thermal resistance of the interface material (Km²/W)
- L is the thickness of the interface material (m)
- K is the thermal conductivity of the interface material (W/mK)
- A is the surface area (m²)

Thermal resistance, measured in Km²/W, is the reciprocal of thermal conductivity. It takes into account the interfacial thickness and although it is dependent on the contact surfaces and pressures applied, some general rules can be followed to ensure thermal resistance values are kept to a minimum and thus maximizing the efficiency of heat transfer. For example, a metal heat sink will have a significantly higher thermal conductivity than a heat transfer compound used at the interface and therefore it is important that only a thin layer of this compound is used; increasing thickness will only increase the thermal resistance in this case. Therefore, lower interfacial thicknesses and higher thermal conductivities give the greatest improvement in heat transfer. In some cases, however, utilizing a material with a higher bulk

thermal conductivity could be to the detriment of contact resistance and thus, no improvement will be accomplished. The table below provides some indications of the differences between thermal management materials and how the combination of properties is more important than a single value alone.

An example of this difference can be drawn from the comparison of thermal compounds or pastes and thermal pads, as shown in table 1. Thermal pads are solid, polymerized materials of a fixed thickness which are available in a variety of thermal conductivities. Thermal compounds or pastes, as discussed above, are non-curing compounds and as a result, their viscosity can alter slightly as the temperature increases. This allows for a further reduction in interfacial resistance. In the case of thermal pads, high pressures are needed to achieve an adequate interface, thus, a paste and pad of similar bulk thermal conductivity may have very different thermal resistance measurements in use, and as such a difference in the efficiency of heat transfer will be observed.

Another concern with using bulk thermal conductivity values alone for product selection is that there are a number of different techniques available. Significant variations in thermal conductivity values for the same product can be achieved by utilizing different test methods or parameters. This can result in bulk thermal conductivity values that appear very high when quoted but in use have a dramatically reduced efficiency of heat dissipation. Some techniques only measure the sum of the materials' thermal resistance and the material/instrument contact resistance. It is better to use a

Table 1:
Comparison of various thermal interface materials

Thermal Interface Material	Bulk Thermal Conductivity	Thermal Resistance	Material Thickness	Reworkability
Adhesives	GOOD	GOOD	EXCELLENT	FAIR
Compounds or Pastes	GOOD	EXCELLENT	EXCELLENT	EXCELLENT
Encapsulants	GOOD	GOOD	GOOD	FAIR/POOR
Thermal Pads	EXCELLENT	FAIR	POOR	EXCELLENT
Phase Change	EXCELLENT	GOOD	FAIR	GOOD

Table 2:
Comparison of effective heat dissipation using different thermal interface materials

PRODUCT#	BULK THERMAL CONDUCTIVITY (W/m K)	DEVICE TEMPERATURE (°C)	REDUCTION IN TEMPERATURE (°C)
No Interface	N/A	30	N/A
1	12.5	22	27%
2	1.0	24	20%
3	1.4	21	30%
4	4.0	23	23%

Figure 2:
Measured true temperature reduction values for several thermal interface materials with different bulk thermal conductivities in a real world application

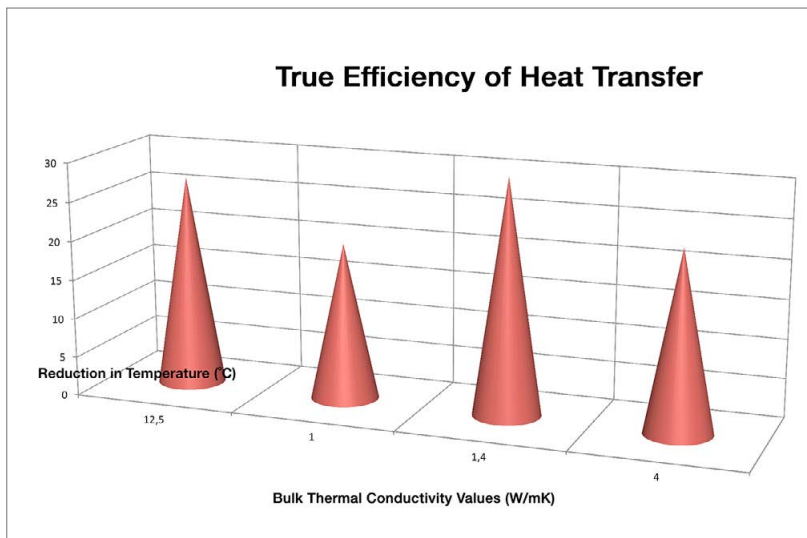

version of the heat-flow method that measures both of these values separately, giving a much more accurate bulk thermal conductivity measurement. Whichever is used, it is essential that products are compared using the same method to obtain bulk conductivity values and in all cases, the products should be tested in the final application for a true reflection of effective heat dissipation.

This leads us to another important factor in product selection, the application of thermal management materials. Whether it is an encapsulation compound or an interface material, any gaps in the thermally conductive medium will result in a reduction in the rate of heat dissipation. For interface materials, the viscosity of a product or the minimum thickness possible for application will have a great effect on the thermal resistance and thus, a highly thermally conductive, high viscosity compound that cannot be evenly spread onto the surface, may have a higher thermal resistance

and lower efficiency of heat dissipation when compared to a lower viscosity product with a lower bulk thermal conductivity value. For encapsulation resins, this could be expressed in a similar way; the higher the viscosity, the more difficult it is for the resin to flow evenly around the unit and therefore, air gaps are formed in the potting compound reducing the rate of heat dissipation. It is essential that users address bulk thermal conductivity values, contact resistance, application thicknesses and processes in order to successfully achieve the optimum in heat transfer efficiency.

A practical example highlighting the requirement for such considerations is provided in table 2 and graph below. It shows the potential differences in heat dissipation by measuring the temperature of a heat generating device in use. These results have been based on work completed by an end user, where all products were thermal interface materials, applied using the same method, at the same thickness.

It is clearly evident that a higher bulk thermal conductivity value, in this case 12.5 W/mK, does not necessarily result in more effective heat dissipation when compared to products with lower values, such as the above at 1.4 W/mK. The reason for this could be due to the processing method not being suitable for the product, for the product not being easy to apply or possibly the product was not designed for this particular application. Whatever the reason, it highlights the importance of product application as well as product selection.

Conclusion

With such rapid advances in the electronics industry and more specifically, LED applications, it is imperative that materials technology is also addressed to meet the ever demanding requirements for heat dissipation. Some companies, like Electrolube, have developed specific technologies to improve the ability to process thermal management compounds, easily and effectively. This has resulted in reduced viscosity compounds with higher bulk thermal conductivities and with these two properties combined these products provide maximum efficiency in heat dissipation by minimizing thermal resistance. This technology has now also been transferred to encapsulation compounds, providing products with higher filler loadings and thus improved thermal conductivity combined with improved flow. ■

Choosing the Appropriate Heatsink for an Application

Next to vibrations and moisture, temperature-related stress on electronic semiconductor elements is the most common cause of failure for electronic components and devices. Effective thermal management is obligatory to ensure durability, reliability and performance. Jürgen Harpain, Manager of Development at Fischer Elektronik explains how different types of heatsinks provide excellent solutions and which one is the appropriate solution for a given application.

There is a direct connection between temperature stress and the life-span of electronic components. The level of the surrounding temperature, the frequency and speed of temperature changes as well as the temperature created in the conductors due to the flow of electricity at higher power densities cause the electronics to malfunction in different kinds of applications. If the maximum operating temperature stated in the manufacturer's datasheets is exceeded this causes malfunctions, while exceeding the permitted limit temperature causes the semiconductor to be destroyed.

by approx. 50%. This fact clearly shows that efficient heat management is unavoidable. The easiest way of limiting the temperature is in accordance with the principle of increasing the surface of the component to be cooled by using suitable media, such as a good conducting heatsink (Figure 1). In accordance with its definition, a heatsink is a mechanical part which is conductively connected to a heat-producing, electronic component, with the aim of discharging heat from the component to the surroundings.

To understand the connections of the cooling, an explanation is needed of the physical key terms of heat quantity, thermal output and heat flow as well as the temperature. Kinetic heat theory defines heat as a molecular movement, i.e. a solid becomes warmer the stronger the molecular movement is. The heat quantity is thereby the total energy of all moving molecules in a medium. Physically, the heat quantity is an energy form and is stated in Joules [J]. The work ΔQ performed over a period of time Δt is stated as a

Figure 1: Specially adjusted aluminum heatsinks to the respective application for a long LED life

Physical Basics

The physical processes in the semiconductor layer create power losses which are converted into heat losses. A live semiconductor creates "heat loss" due to electrical resistance which occurs as a result of the collisions of the electrons and atoms when switching binary modes. Frequency-related charge shifting increases the energy requirement and thereby causes this "heat loss". The more often a switching is performed, the more heat is created. Generally the following rule applies: for each temperature increase of 10°C the expected life-span of electronic components and systems is reduced



quotient ($\Delta Q / \Delta t = P$) and the thermal output (P) in Watts [W]. As this thermal output is undesired when running electronic systems and components due to the conversion of electrical energy into heat, this is also called a power loss. The heat quantity per time unit flowing through electric components when in operation is called the heat flow [W]. The kinetic energy content of the molecules of a solid is called the temperature, whereby the unit [°C] and Kelvin [K] are compared.

The actual heat transfer is performed by conduction, convection and radiation. The conductive transfer of heat (thermal conduction) is a molecular heat propagation in media such as solids or static fluids. The radiative heat transfer (radiation) is a transfer of electromagnetic waves between two surfaces, while the convective heat transfer (convection) occurs between solid surfaces and the circulating fluid (air). Here material parts of a medium change their position in the room, if, for example, an uplift is created by a temperature-altering change to the density of the air (free convection). All three transfer methods are present, to various extents, in a heatsink.

Production of Heatsinks

Selecting a heatsink by considering the mechanical conditions and requirements as well as thermal criteria is extremely important for the long-term and safe functioning of modules, devices or systems. Making the correct choice of heatsink based merely on the dimensions, length, width and height is no longer enough. To assess the quality it is just as important to gain an understanding about the production-related conditions which have to be observed right from the start of the projection phase because they have considerable influence on the overall quality. The materials used for the heatsink mainly consist of aluminum alloys which have a good relationship between price, performance, volume and weight, and are also relatively easy to mechanically process. The specific heat conductivity (λ) of a material is to be strictly determined for good heat conductivity. The alloys used have values of $\lambda > 200$ [W/m·K] and are common in diverse sub-divisions.

In particular, the mechanical criteria and tolerances for the extruded profiles used have to be taken into account in the overall concept, as the manufacturing process

and the achieved tolerance levels achieved are subject to international standards. Here the heatsink is often a component installed in a device which is always to be viewed in connection with other components. Produced in an extrusion process, heatsinks consist of so-called wrought alloys, i.e. when forming the heated aluminum material (to approx. 480°C) it is pressed by a die-plate, with the inserted heatsink geometry negative. The alloys used, mainly contain aluminum, magnesium and silicon and are called EN AW alloys in Europe. The abbreviation EN stands for European Norm and AW for Aluminum Wrought. In the industrial heatsink sector the alloys EN AW 6060 (previously AlMgSi0.5) and 6063 (previously AlMgSi0.7) are mainly used as the standard materials for extrusion profiles which cover the biggest share of corrugated heatsinks. The strength category is T66 (previously F22) in accordance with DIN 755-2 with a tensile strength (R_m) for the alloy EN AW 6060 of approx. 195-215 MPa and for EN AW 6063 approx. 225-245 MPa. Special alloys and other strength values can, of course, be produced but they require precise testing and are severely dependent on the tonnage.

The high deformation forces generated during the extrusion process induce corresponding high tolerances on the profile, which is why great efforts have to be taken to minimize these tolerances. The underlying DIN standards allow a plus/minus tolerance range, depending on the size of the profile, ranging from a few tenths to several millimeters. Here not just the length, width and height of the profile have to be taken into account, but also the angular deviation (incline), twisting and plane parallelism as well as the wall thickness tolerance or curve (convex/concave) of the cross-section. For heatsink profiles with a circumscribed circle of less than/equal to 350mm (precision profiles) the press tolerance as per DIN EN 12020 applies, while DIN EN 755 applies to profiles with a circumscribed circle of greater than 350 mm. The production of profiles with a limited tolerance field is possible after careful consultation with the heatsink manufacturer, depending on the profile cross-section, although due to the low flow rate per time unit when extruding there are often additional costs. The total of all the advantages of wrought aluminum profiles,

fischer

elektronik

to cool to protect to connect

Electromechanics for LEDs

- various LED heatsinks
- versatile thermal conductive materials
- LED connectors for LED-line module and PCB
- special solutions and versions for your special application



For more details
please check our website:
www.fischerelektronik.de

Fischer Elektronik GmbH & Co. KG

Nottebohmstraße 28
D-58511 Lüdenscheid
Phone +49 (0) 23 51 43 5-0
Fax +49 (0) 23 51 4 57 54
E-mail info@fischerelektronik.de
www.fischerelektronik.de/facebook



We exhibit: 14.-16.05.2013
PCIM Nuremberg
hall 9, stand 215

Figure 2:
The thermal resistance R_{th} compared to the required heatsink length with the stated cross-section area of the heatsink

such as the relative low unit and profile tool costs, the easy creation of prototypes, the good thermal conductivity of the base material, the relatively low weight, the good thermal resistance and the wide range of versions available on the market make heatsinks an efficient and attractive cooling concept.

Thermal Resistance and Heatsink Calculation

The thermal technical data of the heatsinks is determined by the manufacturer using calculations, simulations or even laboratory tests. Even once the users are aware of the technical background of cooling, the selection of a suitable heatsink for specific problems is still not particularly easy. Accompanying boundary conditions need to be observed as they often have such an effect that they should not be disregarded. Often the optimum circuit-technical positioning of the electronic components cannot be harmonized with the best heat-technical solution.

The selection and use of heatsinks requires an assessment of certain criteria, which have a considerable effect on the selection of a suitable heatsink. Essentially the selection should be made after listing the thermal criteria (datasheet from the manufacturer), the calculation of the thermal resistance and considering the installation situation and the space available. In particular the calculation of the thermal resistance provides a very helpful statement about the required heatsink size, geometry and length. According to the physical definition, thermal resistance is resistance against the flow of heat in solid, liquid and gaseous media. This is inversely proportional to the heat resistance, i.e. the lower this value the better the component or heatsink dissipates heat. The unit for thermal resistance (R_{th}) is stated in Kelvins per Watt [K/W]. This is calculated according to the 2nd main clause of thermodynamics from a temperature difference which the power loss to be cooled is divided against. The known dependencies

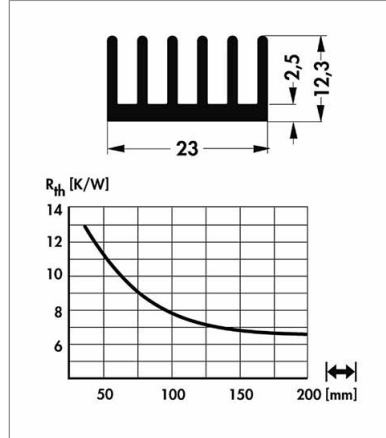

from thermal technology and the assessment of thermal management therefore cause temperature and power loss dependencies with the calculation of the general thermal resistance using the formula:

$$R_{th} = d / \lambda \cdot A$$

whereby the influencing factors consist of

- d thickness/length of the heat path in [m],
- λ the thermal resistance of the material in [W/mK] and the
- A cross-section surface of the heat transfer in [m²].

When using the given material values and known temperature or power losses details can be found in the manufacturer's datasheet, and now the thermal resistance relevant for the choice of heatsink is calculated in

accordance with the Ohm's law. The temperature difference ΔT between the semiconductor junction and the surroundings ($\Delta T = T_J - T_U$) of the heat sink is calculated from the power loss P_V in [W] and the total of all thermal resistance R_{th} . The total thermal resistance consists of a series connection of the individual partial resistances along the thermal pathway, which has to overcome the thermal current. This leads to the following general rule:

$$R_{th} = \Delta T / P_V - (R_{thG} + R_{thM}) = T_J - T_U / P_V - (R_{thG} + R_{thM})$$

For an estimated calculation the additional thermal transfer resistance (R_{thG} = inner thermal resistance of the semiconductor and R_{thM} = thermal resistance of the installation area/ thermal conductor material) can be added to the calculation, even with a charged temperature reserve of the maximum junction temperature of the semiconductor. With the thermal resistance calculated in this manner, a heatsink can be selected under consideration of the further boundary conditions and using the numerical details, diagrams or graphics (Figure 2) shown in the catalogues of the heatsink manufacturer. The right thermal resistance for the stated cross-section is calculated at the intersection of the characteristic curve with the associated heatsink length.

Figure 3:
The size of the heatsink has to be adjusted before each design-in to the size of the electronic component to be cooled

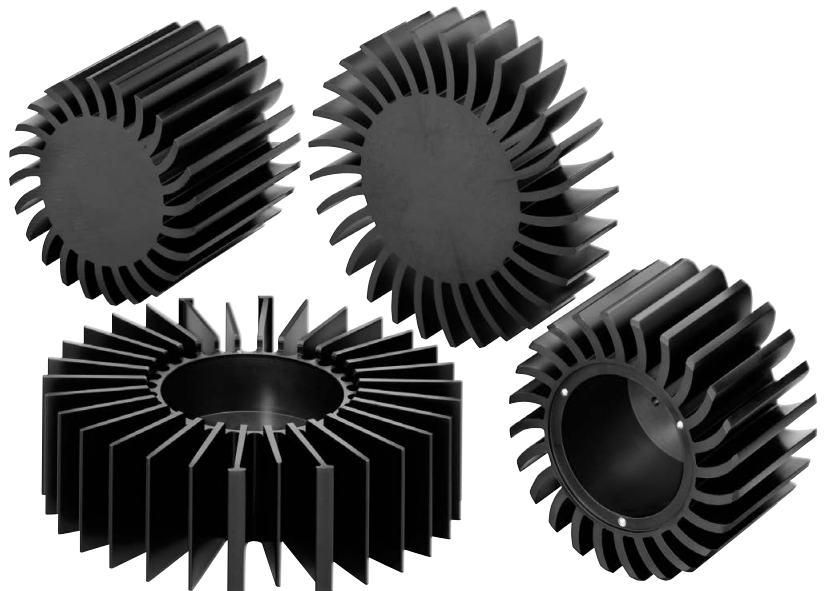

Heatsinks for Natural Convection

In the development of the electronic design, a calculation of the required space, weight, volume and installation space for the heatsink should be carried out right at the beginning, as the calculation of the thermal concerns directly entails the ascertainment of the cooling system and therefore the installation size.

If the special features of the thermal path are not considered when creating the design, subsequent changes to the specifications are often annoying, time-consuming and cost-intensive.

The geometric dimensions of the corrugated heatsink (Figure 3) should be determined with free convection on the respective component size of the semiconductor, including the LED, so that the heatsink contact surface, normally on the base, is used homogeneously and the heat input can occur across the whole surface. For isolated and very small heat input surfaces, as well as for time-dependant (transient) heat input, the heatsink design under free convection has to be especially observed. In these thermal conditions it is necessary, for the effective cooling of the electronic component, to quickly absorb the emitted heat from the component through the heatsink, in order to prevent the junction temperature being exceeded. This may be linked

to the use of contact surfaces for the distribution of heat which are form-fitted to the heatsink, e.g. made of copper ($\lambda = 380 \text{ W/m}\cdot\text{K}$), or made using high-performance heat-conductive anisotropic graphite film. Depending on the application and the installation conditions of the semiconductor to be cooled, in the heatsink selection process you should always pay attention to the correct ratio between the heatsink width and length, base thickness, fin height, thickness, quantity and distance, while also taking into account the calculated thermal resistance and the component size.

The length of the heatsink also has to be adjusted to the dimensions of the component. As evident in the picture (Figure 2), the heatsink goes into a kind of saturation range (linear curve) above a certain length, i.e. at a certain length it does not make any sense from a heat technical perspective to increase the length of the heatsink. An improvement of the thermal resistance now occurs by increasing the surface due to adjusting the width of the heatsink or the height of the fins. Particular attention also has to be paid to the correct fin distance of heatsinks that are ready to use. The surface cannot be increased as desired by the number of cooling fins, as with the structure of the heatsink you have to be aware that depending on the different geometry and temperature

fields the individual fins can influence each other, e.g. as a result of a fin distance that is too low. Cooling under free (passive) convection occurs due to a difference in the density of the surrounding air caused by the temperature differences, in the form of a convective exchange of heat. The heated air is specifically lighter, there is uplift where cooler air flows and continual air movement is thereby established. In the convective transfer of heat the different types of fin geometries and the distances of the fins from each other are subject to the so-called barrier assessment (bypass effect). This barrier is the accumulation of non-moving air molecules on the fin walls and prevents a direct transfer of heat to the flowing medium (air). If the boundaries of two adjacent fins of a heatsink grow together, the transfer of heat is very strongly reduced. A greater fin distance is needed; high fins in particular need a greater distance as the boundaries above will be thicker.

The height of the fins of a heatsink, in a vertical position, to the base plate, should not be exaggeratedly high for economic reasons. This does not just depend on the material, but also on the cooling method currently applied (passive or active convection). The optimum fin height or fin effectiveness can be relatively easily calculated using analytic methods e.g. Wutz. Essentially it has to be determined that for higher fins the effectiveness does not increase significantly, as not much more heat can be transported to the tips and the fin tips virtually "cool down". The greater the fin height used, the thicker the individual heatsink fins. The preferred installation position for heatsinks in natural convection is determined according to the principle of the stacking effect (vertical floor area), in which the heated air can rise by convection current (uplift) without obstacle (Figure 4, left). Some deviating installation positions lead to significant efficiency losses (Figure 4, right) which have to be taken into consideration in the thermal calculation.

Figure 4:
The correct installation (left) position of heatsinks for free convection should always be taken into account (right image shows an inappropriate mounting solution)

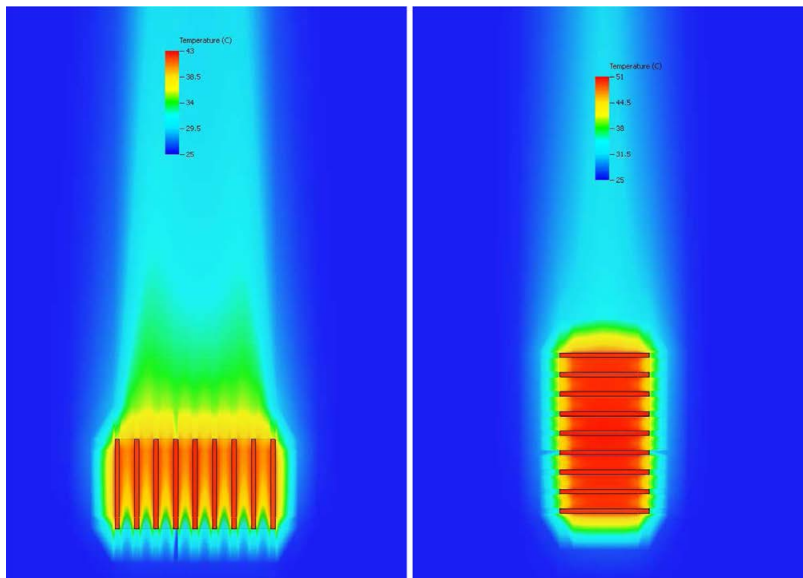

Figure 5:
Customer-specific
processed
heatsink
solutions with
efficient thermal
management
adapted to
the respective
application



Machined Heatsinks and Surface Treatment

The connection of the component to be cooled to the heatsink is particularly important, as if the heat transfer from the component to the radiator is bad, the thermal convection and heat transfer are reduced and the component temperature is considerably increased. This can limit the function and an uncontrolled increase in temperature or even destruction is possible. The optimum heat transfer between the component and the heatsink is only reached if the tolerances, irregularities and roughness of the surfaces to be connected, which are unavoidable due to the production process, are equalized and air pockets which prevent the transportation of heat are avoided.

In the event of the machined processing of a heatsink, such as the milling of corners, drilling of holes or threads, the general tolerances as per DIN ISO 2768, with the tolerance class (m) for medium, normally apply, provided nothing else is stated in the diagram. If face milling is performed on the base surface or mounting area for electronic components due to irregularities, it has to be ensured that the stated thread depths can be reduced, as the base plate of the

heatsink is equally thinned due to material wear. If the cutting diameter is smaller than the area to be cut in the face milling for production reasons, so-called milling edges are visible due to parallel milling. They are edges that measure a thousandth or at the most, a hundredth of a millimeter and could have an influence on the functioning of the heat transfer or the assembly. If these cutting paths are not to be visible, it is advisable to state in the diagram the areas where no milling edges are desired. The explanations given show that allocation and classification of pressing and production tolerances are thoroughly unproblematic, if the available options for influencing them are used knowledgeably. A detailed summary of the criteria for selecting a heatsink, related to the respective area of application, also allows costs and delivery times to be reduced.

Surface requirements for corrosion protection or even on the decorative appearance have a considerable influence on the effectiveness of the heat dissipation of a heatsink. For aluminum heatsinks anodized surfaces are very sensible, regardless of their color. Alongside the known corrosion protection effect of anodized surfaces, when these

oxide layers (12-15 µm) are applied there is a surface structuring in the nanometer range. As a result, the heatsink gets improved heat dissipation of approx. 8% to 10% in free convection. The physical connection between heat dissipation, thermal radiation and the emission factor is shown by the formula:

$$Q = \varepsilon \sigma A T^4$$

with

- Q radiation power,
- ε emission ratio 0.55 (for black anodized aluminum),
- σ Boltzmann constant,
- A surface of the radiating solid,
- T temperature of the radiating solid (in Kelvin).

As already stated in the afore-mentioned formula, anodized layers have an emission factor of approx. 0.55, whereby coated surfaces, e.g. for decorative applications, have an emission factor of > 0.9. A negative point of this is that anodized layers have a heat conduction value which is approximately 10 times lower than that of aluminum. To reduce the thermal transfer resistance it is therefore sensible, in heat-technical threshold ranges, to remove this anodized layer in the assembly area of the electronic components by milling, after the anodizing process.

Conclusion

One of the most urgent problems in electronics today, including LED technology, is the efficient cooling of electronic semiconductor parts. Due to the high processing speeds, constant minimization of components with increasing power losses, the thermal problems have a significant effect on a possible system malfunction or in the worst case even the destruction of a component. Advanced heatsink technology is therefore a must for efficient thermal management. For some applications, tailor-made solutions (Figure 5) are the first choice. Established and experienced manufacturer of heatsinks like Fischer Elektronik, with its 40 years of experience, provide such tailor-made solutions and production feasibility. ■



LED Lighting Taiwan

The 9th Int'l LED Lighting Exposition
www.optotaiwan.com

Exhibits

- LED Lighting Fixture
- LED Applications
- Package / Module
- Epi Wafer / Chip
- Materials
- Processing Equipment
- LED Plant Factory
- OLED Lighting



2013
June 18 -20

TWTC Nangang Exhibition Hall

VIP BUYERS Inviting!

Free Accommodation / Flight Ticket

Organizer



Photonics Industry & Technology Development Association
5F, No.9, Sec.2, Roosevelt Road, Taipei 10093, Taiwan
Tel : +886-2-2351-4026 Fax : +886-2-2396-8513

[Overseas contact]

Vanessa Hou (ext. 883) E-mail : vanessa@mail.pida.org.tw



eurolED™

SHOWCASING CUTTING EDGE LED AND SOLID STATE LIGHTING



24th - 25th June 2013 , The ICC, Birmingham, UK



Visit Europe's
key event for
the Science and
Technology of
LEDS



Show Highlights:

High profile, technical conference programme
Over 100 exhibitors expected from all over the world
Network with a vast number of industry professionals
Catch up on all the latest in LED innovations



Conference from £199 + VAT
Exhibition Free to Attend
Gala Dinner from £65 +VAT

Register now at www.euroLED.org.uk

Contact the team: Michelle Cleaver or Katie Fulcher on +44 (0)121 250 3515 or info@euroLED.org.uk



Protecting LEDs from Electrical Overstress Faults

While LEDs are reliable under standard conditions, they are vulnerable when electrical parameters exceed the specified limits. Joe Dinkel, Field Application Engineer, and Spencer Guo, China Application Engineering Manager at TE Circuit Protection propose a cost-effective solution and describe how it works.

With their ability to increase energy savings and reduce power consumption, LEDs offer an attractive option for lighting manufacturers who need to develop the latest-generation designs. But, at the same time, LEDs are vulnerable to damage caused by any undesirable voltage, current or power event that lighting applications can be subjected to, which can ultimately result in costly product returns and warranty issues. As a result, there is an increasing awareness in the industry about the need for protecting LEDs against damage from EOS (electrical overstress).

A hybrid device that combines a PPTC (Polymer Positive Temperature Coefficient) and a Zener diode can help protect LED applications from damage from EOS faults. By using this approach, PCB designers now have a simple overcurrent/overvoltage solution that is also efficient, cost-effective and space saving.

Integrated Protection

EOS events are typically transient; meaning they occur for a short period of time - typically less than one second - and are often referred to as spikes (e.g., current spikes or voltage spikes). However, EOS events can be permanent, such as the result of a battery being inserted backward into a battery-powered LED flashlight. Any single EOS event, long or short in duration, or any number of events, has the potential to cause damage to the LED. This damage can be exhibited either as an immediate failure or a failure that occurs many hours after the EOS event. LED applications are vulnerable to damage when the EOS event exceeds the maximum requirements of the design's specifications.

As an EOS fault mitigation solution that is also suitable for space-constrained LED lighting designs, the PolyZen device combines two thermally bonded devices: a precision Zener diode and PolySwitch PPTC (Polymer Positive Temperature Coefficient) device (Figure 1). In essence, by providing a thermally protected Zener diode, the device offers multiple benefits in a single

package, including helping to protect electronics against the failures caused by voltage transients, reverse-bias, overcurrent, and the incorrect use of power supplies.

The product series of PolyZen products includes two families, differentiated by part numbers ending in either "LS" and/or "CE." Each family offers combinations of different Zener voltages (V_z), PPTC hold currents (I_{HOLD}), and input voltage ratings (V_{intmax} - referred to as V_{in}) options. This range of products offers designers a variety of devices that can be used in a wide range of practical applications requiring overcurrent/overvoltage protection.

As a protection device that integrates both a high-performance Zener diode and a PPTC overvoltage/overcurrent protection device, the PolyZen device enhances the performance of existing discrete solutions that employ only a separate fuse, Zener diode or other passive element. For example, commonly used transient voltage suppression (TVS) devices, although capable of voltage clamping, are limited in their ability to provide short-duration impulse protection.

Figure 1:
Schematic of PPTC and Zener integrated PolyZen device

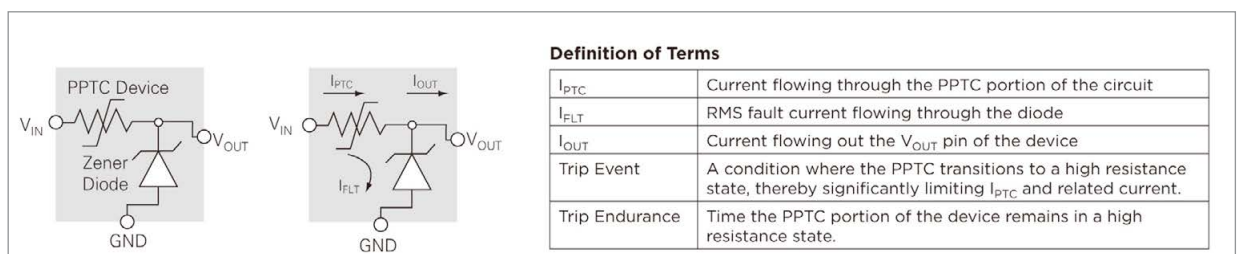

In a typical TVS application, a clamping diode will rise in temperature during an overvoltage fault and subsequent breakdown. If the fault is not eliminated and the overvoltage impulse is applied to the circuit for an extended period of time, a high-energy TVS device is needed to protect the circuit; otherwise, the TVS device itself can be permanently damaged from thermal degradation. However, adding a high-energy TVS device is costly and its large package size consumes valuable board space. Additionally, this scheme only provides overvoltage protection and does not address overcurrent protection.

The PPTC component in the PolyZen device helps designers provide necessary overcurrent protection quickly and effectively, as would a standalone PPTC device. As a result, designers are offered an alternative to integrating and testing space-consuming discrete devices or employing expensive IC solutions for combination overvoltage/overcurrent protection.

Device Concept

When an overvoltage fault occurs in an application using a PolyZen device, the device's Zener diode and PPTC operate in conjunction to help provide protection. The protection occurs because as the Zener approaches a clamp voltage, the current flowing in the Zener causes it to rise in temperature. Since the PPTC is thermally bonded it also is exposed to the increase in temperature and this causes the PPTC to trip, or go into a high-resistance state. The device's I_{OUT} and I_{FLT} will be greatly reduced, protecting the downstream electronics.

The overvoltage fault protection occurs when the Zener clamps, whether the diode is forward- or reverse-biased. A precision Zener diode is utilized in the PolyZen device based on its ability to permit current flow in either direction.

When a positive voltage on V_{IN} , with respect to GND, approaches the V_z value of a particular PolyZen device, it will reverse-bias the diode and the current I_{FLT} will flow in the direction (Figure 1), which is through the PPTC and into the cathode and out the anode (GND).

While shunting the current, the diode will clamp at V_z of the particular PolyZen device, generating heat within the Zener and transferring the heat to the PPTC, thus causing it to trip.

If there is a reversal of voltage polarity from V_{IN} to GND, the current I_{FLT} will flow in the opposite direction (forward-biased) as it approaches a clamp voltage. In a forward-bias the Zener will clamp at the diode-drop of the particular PolyZen device instead of at V_z . The current flowing in the Zener will create heat, transfer the heat to the PPTC, thus causing it to trip. As mentioned above, I_{OUT} and I_{FLT} will be greatly reduced, thereby protecting both the PolyZen device and the downstream electronics. Reverse-polarity protection is thus provided as well.

In the case of an overcurrent fault, where current is flowing from V_{IN} to V_{OUT} (I_{PPTC} or I_{OUT}) and the Zener is not clamped, the PPTC will respond just as any standalone PPTC device would. The PPTC has an I_{HOLD} specification, and if it is exceeded, the PPTC will also "trip" to a state of high resistance, rapidly cutting off excessive current at I_{OUT} (More details on the PolyZen device's Zener and PPTC parameters are included in the individual PolyZen specifications).

Whether or not an overvoltage and/or overcurrent EOS event causes the PPTC to trip, the protection provided by the PolyZen device is resettable, unlike providing one-time protection, such as using a fuse as an overcurrent protector with a discrete Zener or TVS device. The unique feature of utilizing a Zener diode bonded to a PPTC device allows the PolyZen device to withstand much more energy than other protection solutions, despite its smaller package size. Additionally, the device is reset whether the Zener clamped when tripping the PPTC or if the PPTC device is tripped without the Zener by cycling power.

A typical fault response of a specific PolyZen device is shown in figure 2. In this example, PolyZen device (p/n ZEN056V130A 24CE) integrates a 5.6V Zener diode (V_z), a 1.3 A I_{HOLD} PPTC, and a 24 V V_{IN} (specified as V_{intmax} but shortened to V_{IN}). V_{IN} is connected to a 24 V, 10 A current-limited power source and $I_{OUT} = 0$.

**FORM. FUNCTION. SIZE.
SHAPE. GLT CAN HELP
ILLUMINATE YOUR LED
FIXTURES ANY WAY YOU NEED.**

**Custom edge-lit light
guide solutions**

**High brightness,
excellent uniformity,
low power**

**Solutions for ceiling, wall, cabinet
& task lighting...and more –
to your specs**

**Standard & custom sizes
and shapes, dimming,
color temperatures...
tell us what you need**

**High-volume manufacturing,
fast turnaround**



Cleveland, USA • Taipei, Taiwan
440-922-4584 • sales@glthome.com
www.glthome.com

Figure 2:
Typical fault response of a PolyZen device

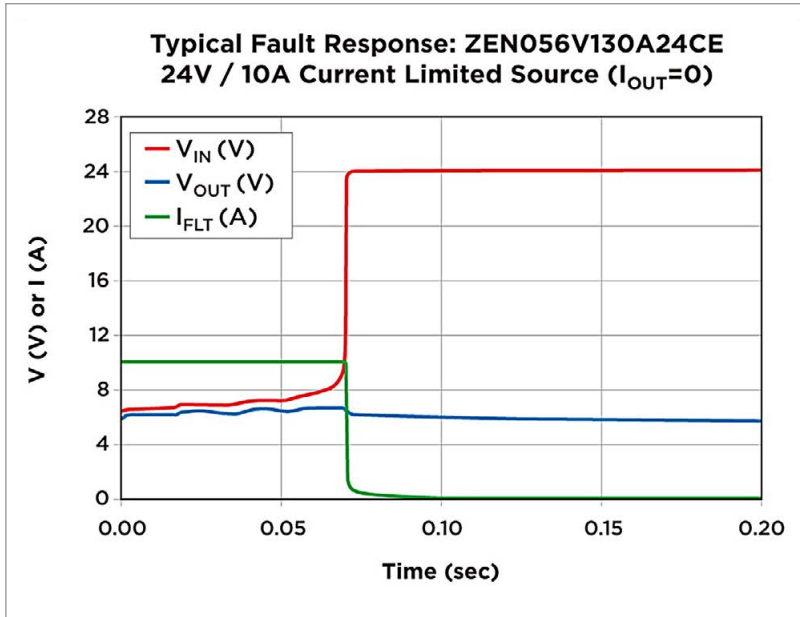

As fault current passes through the system under a 24 V overvoltage (V_{IN}) fault, the PolyZen device's precision Zener diode clamps the output voltage at the Zener clamp voltage V_z (~5.6V) in order to protect the load circuit. At the same time the PPTC device trips, cutting off the current to help protect the Zener diode as well as the entire circuit.

As previously described, EOS faults are typically transient, but they can also be permanent. Basically, when the energy of the voltage or current spike (i.e., EOS fault) exceeds the LED's specified design values, the LED can be damaged. EOS faults can cause the immediate breakdown of the LED or, in some cases, can cause failure only after the EOS event has been present for a period of time.

EOS Fault Test Examples

Typical scenarios in which EOS faults can originate in LED applications are from instability in power supply output, noise generated by overvoltage/overcurrent conditions, component degradation, and from current inrush in hot-swap applications.

A basic test platform was set up to simulate the EOS fault signal in an LED application. The basic schematic is shown in figure 3. Several components, including the capacitor and PolyZen device shown with "blue" boxes, were inserted at different phases of testing.

Figure 3:
EOS simulation test platform diagram with PolyZen device protection (with added capacitor to deteriorate the EOS signal)

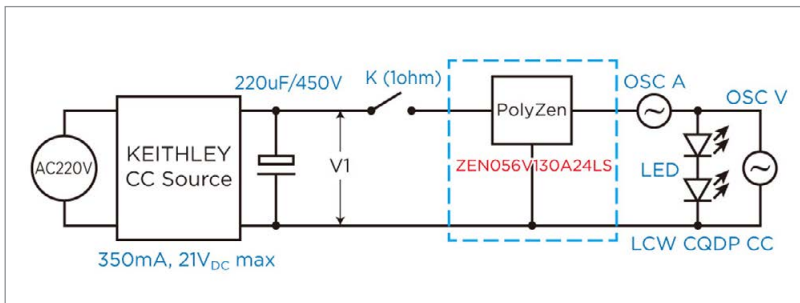

Table 1:
LED rated parameters

Forward current ($T_s = 25^\circ\text{C}$)	(min.) (max.)	I_F I_F	100 800	mA mA
Surge current $t \leq 50\text{ms}, D = 0.016, T_s = 25^\circ\text{C}$		I_{FM}	2000	mA
Reverse voltage ($T_s = 25^\circ\text{C}$)		V_R	not designed for reverse operation	V

A Keithley Model 2410 SourceMeter test was used as the source of the output voltage/current in the test system. The circuit - similar to the one shown in figure 3 but without the capacitor or the PolyZen device inserted - connected a switch in series for on/off switching of the complete circuit. A commercially available LED was selected to evaluate the impact of EOS, including the rated capacity of the LED for surge current (Table 1).

The transient power, which can result in LED failure, can be calculated according to the following Formula 1:

$$I^2tD = 2^2 \times 0.016 \times 0.05 = 0.0032 \text{ (A}^2\text{s)}$$

- I Current - peak value
- t Time - duration of current
- D Duty cycle of current

Thus, the LED device can be damaged if the energy of the transient spike in the output of the test system power supply exceeds this value.

The results of the circuit when the test was started show that the oscilloscope captures the transient voltage/current waveform of the test system as it begins operation (Figure 4a).

The measured values are:

- Spike voltage = 4 V
- Spike current = 1.5 A
- Time duration = 340 μs

In this situation, where the waveform is similar to a triangular wave, EOS energy can be calculated using the following Formula 2:

$$0.5I^2t = 0.5 \times 0.15^2 \times 0.00034 = 0.00038 \text{ (A}^2\text{s)}$$

- I Current - peak value
- t Time - duration of current

Based on the data derived from Formula 2, the noise energy of the spike is below the rated limit of a surge that would damage the LED device; which means the LED is safe under this condition. But this test uses the Keithley SourceMeter instrument, which is able to deliver a high-quality

Figure 4: Transient impulse waveforms from the Keithly SourceMeter test (a). Transient impulse waveforms from the Keithly SourceMeter test - with added capacitor to deteriorate the EOS signals (b). Transient impulse waveforms from the Keithly SourceMeter test - with added capacitor and with PolyZen protection (c). Transient impulse waveforms from the Keithly SourceMeter test - with added capacitor, where two LEDs are protected by a PolyZen device (d)

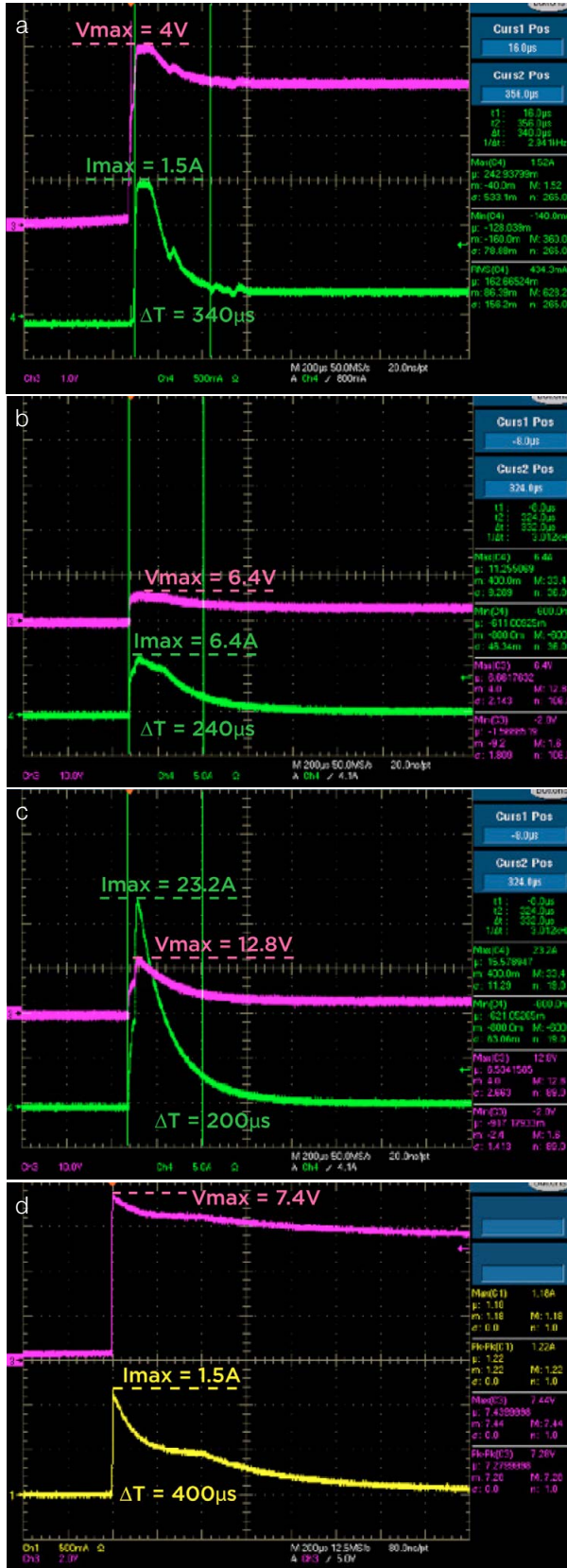

The next test simulates the harsh conditions of power supplies in actual day-to-day applications. Based on the test platform (Figure 3), a capacitor (rated at 220 μF/ 450 V) is inserted in the output of the voltage source to deteriorate the quality of the Keithley output, thus introducing EOS type signals. This also provides a more real-world response based on what an LED application would be subjected to.

This experiment evaluates how PolyZen devices help to mitigate EOS faults. The PolyZen device EN056V130A24LS, which integrates a Zener diode rated at 5.6 Vz, 1.3 A I_{HOLD} and a PPTC (24 V V_{INMAX}), was placed after the capacitor. The first portion of the experiment shows the response of the circuit with the capacitor inserted and the second portion shows the response with the capacitor and PolyZen device inserted.

In the first part of the test, the capacitor has been inserted into the circuit, and shows what happens when a PolyZen device is not used to protect the circuit. After switching on the power, the current/voltage transient impulse waveform, illustrated by the oscilloscope (Figure 4b), shows the following:

- Spike voltage = 23.2 V
- Spike current = 12.8 A
- Time duration = 200 μs

The energy of this EOS waveform is calculated according to the following Formula 3:

$$0.5I^2t = 0.5 \times 23.2^2 \times 0.0002 = 0.054 (A^2s)$$

- I Current - peak value
- t Time - duration of current

According to Formula 3, 0.054 A²s of the EOS energy can be obtained, which exceeds the rated LED surge current. The LED lifetime will be shortened, and the LED will probably sustain direct damage if it operates under these power-supply conditions for an extended period of time.

As shown previously (Figure 3), the next portion of the experiment has the capacitor and a PolyZen device connected in parallel and placed in front of the LED. Because the PolyZen device integrates a Zener diode for comprehensive overcurrent/overvoltage protection, it is able to clamp the output voltage, as well as shunt fault current effectively to protect the load circuit. In this test, a spike voltage/current waveform was obtained (Figure 4c). The results indicate:

- Spike voltage = 6.4 V
- Spike current = 6.4 A
- Time duration = 240 μs

The energy of this EOS waveform is calculated according to the following Formula 4:

$$0.5I^2t = 0.5 \times 6.4^2 \times 0.00024 = 0.0049 (A^2s)$$

- I Current - peak value
- t Time - duration of current

voltage/current that actually assists in the protection of the LED from EOS damage. However, in real-world applications, engineers would have to spend additional time and cost in the design and construction of the type of high-quality LED power supply that is required to protect against EOS faults. In most markets, adding extensive cost to the power supply is not a practical solution, and therefore compromises must be made.

Figure 5:
The block diagram of the EOS simulation test platform (one PolyZen device protects two LEDs)

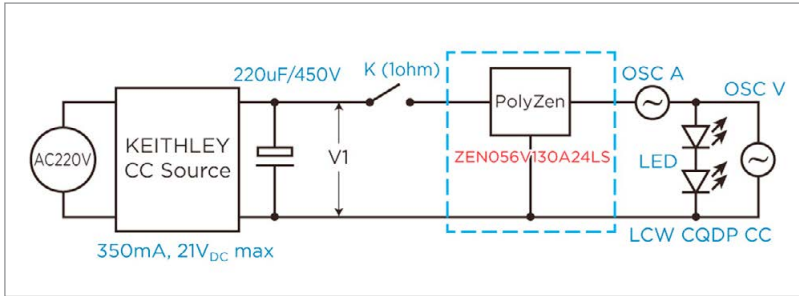

In this test the PolyZen device significantly improves protection from EOS events by decreasing the EOS energy from 0.054 A²s to 0.0049 A²s. In a real-world application of a power supply exhibiting EOS, the PolyZen device offers protection that is an order of magnitude better than using nothing at all.

The value obtained in Formula 4 is slightly higher than in Formula 1; however, protection of the LED was maintained. In other words, the PolyZen device effectively reduces the fault current and thus improves EOS event protection by quickly clamping the fault voltage.

The next experiment employs a PolyZen device to illustrate a cost-effective solution for helping to protect LEDs that are often used in actual applications. With the goal of protecting two LEDs with a forward voltage (V_f) of 3 V, the PolyZen ZEN065V130A24LS device was selected for its Zener diode of 6.5 V_Z, 1.3 A I_{HOLD} PPTC, and 24 V V_{IN} rating.

The schematic circuit diagram of the test system is shown in figure 5.

The waveform on the oscilloscope (Figure 4d), indicates:

Spike voltage = 7.4 V,
Spike current = 1.5 A,
Time duration = 400 μs.

Therefore, the energy of the EOS waveform can be calculated using Formula 5:

$$0.5I^2t = 0.5 \times 1.18^2 \times 0.0004 = 0.00027 (A^2s)$$

I Current - peak value
t Time - duration of current

The EOS energy is less than the value calculated with Formula 1, which can cause LED failure. Therefore the LED can operate safely within this power environment. In this application, EOS protection is provided effectively by the PolyZen device, and the LED is also protected.

Summary

LED lighting designers need to protect their applications from EOS faults that can potentially lead to damage and cause reliability issues. As the results of the experiments presented in this article illustrate, a hybrid PolyZen circuit protection device that incorporates a PPTC and Zener diode offers many advantages for LED applications, including:

- Lowering EOS energy levels significantly to help protect LED devices and extend their lifetime.
- Reducing complexity and cost in LED power-supply designs.
- Providing multi-functional resettable protection against overcurrent/overvoltage conditions and mitigate high energy states.
- Offering a space- and cost-savings alternative to high-power, physically large TVS diodes, as well as other discrete components attempting to offer similar functionality.

Additionally, the device's slim-profile package and advanced protection features are suitable for helping to protect a wide range of sensitive electronics from damage resulting from overvoltage and overcurrent events. ■



20 Watt LED Driver RACD20/277 for Global Use

The RACD20/277 offers a universal input voltage range of 90VAC to 305VAC and thus, they are suitable for global use, in both 115V and 230V networks. The series is available with constant output currents of 350mA, 500mA, 700mA or 1050mA. All modules comply with IP66, provide standard active power-factor and impress with their very compact, slightly rounded shape. They are fully certified according to the European safety regulations and also comply with EMC. The drivers are designed for reliable, durable operation and come with a 5 year warranty.



info@recom-lighting.com



Helps you to sell!

Italian association of electronic suppliers



ILLUMINOTRONICA

LIGHTING & ELETTRONICA ...and not only

for those who
are looking
for ^{new} **light**...

...seize the
opportunities
of LEDs

Illuminotronica
10th / 12th October 2013

Padua *at* Fiera di Padova - hall 11

SECRETARY: Ph. +39 02 210 111 236
e-mail: marketing@fortronicforum.com

www.illuminotronica.it

ORGANIZATION:



assodel

Italian
Association of
Electronic
Suppliers



TECNO
IMPRESA

Consorzio
Tecnoimprese

IN PARTNERSHIP WITH:



casa
tecnica

PadovaFiereSpa



LUMEN

Consorzio
Elettrimpex
Lumen
International

Imprint

LED professional Review (LpR), ISSN 1993-890X

Publisher

Luger Research e.U.	phone	+43 5572 394 489
Institute for Innovation & Technology	fax	+43 5572 394 489-90
Moosmahdstrasse 30	email	editors@led-professional.com
A 6850 Dornbirn, Austria / Europe	web	www.led-professional.com

Publisher

Siegfried Luger	phone	+43 5572 394 489-70
	email	s.luger@led-professional.com

Editor-in-Chief

Arno Grabher-Meyer	phone	+43 5572 394 489-18
	email	a.g-m@led-professional.com

Int. Account Manager

Theresa Koenig	phone	+43 5572 394 489-20
	email	theresa.koenig@led-professional.com

Marketing & Sales Manager

Katharina Fink	phone	+43 5572 394 489-43
	email	katharina.fink@led-professional.com

Cover-Page

Image: Arno Grabher-Meyer, LED professional; Nuventix SynJet R150-170
Artwork: Thomas Klobassa, ©LED professional 2013

Copyrights – Luger Research e.U.

The editors make every reasonable effort to verify the information published, but Luger Research e.U. assumes no responsibility for the validity of any manufacturers, non profit organisations or individuals claims or statements. Luger Research e.U. does not assume and hereby disclaims any liability to any person for any loss or damage caused by errors or omissions in the material contained herein, regardless of whether such errors result from negligence, accident or any other cause whatsoever. You may not copy, reproduce, republish, download, post, broadcast, transmit, make available to the public, or otherwise use LED professional Review (LpR) content without prior written consent from Luger Research e.U. – Institute for Innovation & Technology, Austria. ■



LED professional Review (LpR) - Annual Subscriptions

LpR Digital Magazine

- 6 issues
- pdf download
- high resolution pictures and graphs
- printable
- commercial use
- access to all previous issues
- Euro 78.80

LpR Printed Magazine

- 6 issues
- Euro 158.40

<http://www.led-professional.com/subscription>

Next LpR: A Status of LED Chips Manufacturing and Packaging Issue 38 - July/Aug 2013 - Short Overview

High-Index Nanocrystals Key to Next Generation Advancements in Lighting

While acceptance of LED and OLED technology has been accelerating, greater efficiency with significantly improved light extraction are required for them to become mainstream. Light extraction materials need to have a very high refractive index while maintaining high transparency and excellent light stability but they also need to be easy to incorporate into existing manufacturing processes. A nanomaterial based solution will be demonstrated and its properties explained in detail.

A New MOCVD Platform for GaN-Based High-Brightness LED Manufacturing

Recently a new MOCVD platform was designed and introduced for high-volume manufacturing of high brightness LEDs. To prove manufacturing readiness, a mini-marathon test with identical recipe for temperature and flow conditions was performed. Data from this test were compared with data from the current standard process and demonstrated excellent growth reproducibility and tool function stability.

LED Lighting Taiwan - Post Show Report

In June 2013, LED Lighting Taiwan, a key-event for SSL technology in Asia will be held. The global players as well as some very interesting startup companies from the region and all over the world will attend the show. The report will disclose the latest technology trends, roadmap plans and visions of these companies.

subject to change

LpS 2013

LED SYMPOSIUM
professional +EXPO

EARLY BIRD
REGISTRATION
OPEN NOW!
FREE EXPO TICKETS

LED Lighting Technologies

International Winning Approaches

EVENT OVERVIEW

LED professional Symposium +Expo (LpS) is Europe's foremost LED lighting technology event for experts in industry and research focussing on general, industrial and architectural lighting applications. LpS covers LED and OLED lighting technologies for components, modules, lamps and luminaires.



Over **1000** visitors from all LED lighting technology fields anticipated.



Top class contributors will present **45** lectures covering highly relevant technologies.



More than **80** exhibitors expected from all over the world.

KEYNOTE SPEAKERS



Dietmar Zembrot

President of LightingEurope and CEO of TRILUX, Germany

“Challenges and Opportunities of the European Lighting Industry”

Effects of Solid-State Lighting on products manufactured by European companies and the strategies of the new LightingEurope organization.



Menno Treffers

General Secretary of the Zhaga Consortium, The Netherlands

“Zhaga - Lowering the Risk and Cost of Getting LED Technology Innovation to Market”

An in-depth discussion of the impact of the Zhaga interface specifications on the competitive light market.



Dr. Alfred Felder

CEO of Tridonic, Austria

“Lighting Module and Component Industry - Market and Technology Opportunities”

Correlations between market and technology activities in Solid-State Lighting; risks and opportunities for module and component manufacturers in a rapidly changing environment.

EVENT PROGRAM

- ▶ **3 Keynotes** | From Opportunities to Strategies
- ▶ **45 Lectures** | From Light Sources to Applications
- ▶ **5 Workshops** | From Design to Standardization
- ▶ **2 Tech Panels** | From Ideas to Solutions
- ▶ **2000 m² Exhibition** | From Technologies to Projects
- ▶ **Light Art Project** | From Imagination to Inspiration
- ▶ **Get Together Event** | From Visitors to Networkers

24-26 SEPTEMBER 2013 | BREGENZ | AUSTRIA

LUGER RESEARCH | Moosmahnstrasse 30 | A-6850 Dornbirn | T +43 5572 39 44 89 | F +43 5572 39 44 89 90 | info@lps2013.com | www.lps2013.com



TRIDONIC
▼ enlightening your ideas

Harvard
www.harvard.edu

OSRAM
Opto Semiconductors

9th-12th June 2013, 18th Guangzhou International Lighting Exhibition Booth No. C02, Hall 1.1

18th-20th June 2013, Photonics Festival in Taiwan Booth No. M519, Hall Nangang Exhibition

10th-13th July 2013, Shanghai International Lighting Exhibition Booth No. 001, Hall E1



4014

Small size, flexible design for finish product.



PW16

Refond special matt lens surface Technology, Completely Solved facula problem.

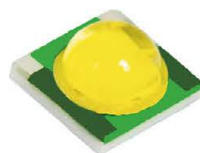

3535

Refond's distinctive silicon molding.



COB

High CRI and luminous, good color consistency easy assembly.



Stock Code: 300241

LED Lighting Source and integral solution supplier.

Tel: +86-755-29675000
www.refond.com

Fax: +86-755-29675111