

LED
professional

www.led-professional.com

ISSN 1993-890X

Review

LpR

The leading worldwide authority for LED & OLED lighting technology information

Nov/Dec 2013 | Issue

40



LpS 2013 Review

Standards & LED Measurement

LED Drivers with Special Features

LED Light Quality

FREE EDITION
CLICK HERE NOW
to see why you should upgrade to the
FULL VERSION

New Lower Cost Single-Stage LED Driver. Best Dimming Performance.

The NEW CS1615A/16A Drive
BOM Costs Even Lower

Cirrus Logic LED driver ICs provide smooth, flicker-free dimming to nearly zero light output

Cirrus Logic's new CS1615A and CS1616A LED drivers feature bill-of-material cost reductions that provide an even greater price comparison to competing single-stage products. And reductions in size and complexity further enhance their compatibility with both A19 and GU10 lamps.

Through proprietary digital intelligence, the CS1615A/16A drivers offer smooth, flicker-free dimming which closely matches the dimming performance of incandescent light bulbs. This series offers full functionality with leading-edge, trailing-edge and "smart" digital dimmers, and consistently outperforms competing LED drivers in dimmer compatibility.

- Bill-of-material cost reductions
- Enables zero – 100% dimming range
- Flicker-free operation across all types of dimmers
- Compatible with smart dimmers

Stay current at www.cirrus.com/ledprocs1615
and request a free sample.



© 2015 Cirrus Logic, Inc. All rights reserved.
Cirrus Logic, Cirrus, the Cirrus Logic logo
designs are trademarks of Cirrus Logic, Inc.
LEDPROC062015



From Component to System Innovations

At the end of September leading experts from research and industry discussed future trends of Solid-State Lighting at the 3rd International LED professional Symposium +Expo in Bregenz. The lighting sector is facing rapid developments made in the semiconductor industry. Standardization will help to some extent but users will also have to accept not always having the latest technology installed.

The experts pointed out that system reliability is key but it should not only be seen as lumen depreciation but also as parameter stability. Nowadays, LED efficiencies ranging from 150-200 lm/W, need further improvements, especially reducing the size of heatsinks or even getting rid of them completely. Further developments of optical materials and reductions of design-in tolerances are still required. Intelligent lighting based on digitally controlled systems, including sensors, wireless control and internet solutions is seen as a major trend. A shift from component innovations to system innovations is taking place in which the combination of available technologies from different areas will lead to new functions and drive the market.

State-of-the-art OLED elements have an efficacy of about 50 lm/W but only 20% of the light leaves the device. The experts agree that OLED in general lighting applications will be ready in about 3-5 years. They say flexibility will be the main advantage of the OLED for creating new products and opening up new areas for applications.

We are still at the beginning of the transition from conventional lighting to intelligent LED/OLED lighting. Besides technology developments, cost of ownership, requirements of applications and the customer's needs always have to be considered.

This issue features a detailed LpS 2013 report and picks up on some important topics that will improve future lighting systems.

Have a great read.

Siegfried Luger

Event Organizer - LpS 2013
Publisher - LED professional

Content

■	EDITORIAL	p 1	COMMENTARY	p 4
	IMPRINT	p 72	NEWS - PROJECTS	p 6
			NEWS - PRODUCTS	p 8
			NEWS - RESEARCH	p 19

■	EVENTS			
	LpS 2013 - A Comprehensive Program, Trends, Innovations and New Product Launches by Arno Grabher-Meyer, LED professional	p 22		

■	INTERVIEW - Michael Gall & Micolaj Przybyla	p 32		
	Light Quality and Standardized Measurement by Siegfried Luger & Arno Grabher-Meyer, LED professional			

■	ELECTRONICS			
	LED Converter With High Dimming Performance by Giulio Borsoi, Mathias Burger & Christian Nesensohn, Tridonic	p 38		
	Intelligent Over Temperature Protection for LED Lighting Applications by Bernd Pflaum & Hakan Yilmazer, Infineon Technologies	p 46		

■	CHARACTERIZATION			
	HD-Retina LED Technology - Light Quality Beyond CRI by Giulio Vezzani, Martini Light	p 52		

■	APPLICATION			
	Light Quality and Appropriate Light Measuring Methods in Demanding Applications by Rich Rosen, Litepanels	p 56		

■	MANUFACTURING	p 60		
	Manufacturing Silicone Lenses and LED Packaging by Tarik Karsandik, Tengifts Technology			

■	SPECIAL TOPICS	p 64		
	Key Technologies – Drivers of the (LED) Lighting Market by Arno Grabher-Meyer, LED professional			

Advertising Index

Cirrus Logic	C 2
Epistar	p 3
Bicom Optics	p 5
Cree	p 7
Honglitronics	p 9
LedLink	p 11
Toshiba	p 13
Konica-Minolta	p 15
Electrolube	p 17
Amphenol LTW	p 17
Barthelme	p 19
Recom	p 21
LpS 2014	p 31
Signcomplex	p 33
Instrument Systems	p 35
Lackwerke Peters	p 37
GSZM	p 37
StellarNet	p 39
Sontronic	p 41
Auer Lighting	p 43
Edison	p 43
Refond	p 45
Lextar	p 50
Honglitronic	p 50
Lighting Japan	p 51
GL Optic	p 55
Semileds	p 55
LED Lighting Taiwan	p 59
LED China	p 59
Taiwan Int. Lighting Show	p 63
Guangzhou Int. Lighting Exhibition	p 71
LED professional	C 3
Arrow	C 4

EPISTAR

www.epistar.com



Actualize LED Potential

----- Co-activation Service

----- Full Spectrum LED Chips

----- Chip Solutions for Various Applications



Website



Facebook



微信



Thor Scordelis

Thor Scordelis has more than 20 years of experience leading lighting design, engineering and marketing teams. Prior to his current role, Thor was PG&E's Emerging Technologies-Lighting Portfolio Manager where he led the identification and assessment of lighting technologies to determine market viability and readiness. Thor was a steering committee member and contributor to the development of California's Strategic Lighting Plan.

BEYOND LM TESTING – A NEW METRIC FOR QUALITY OVER LIFETIME

In a recent blog post, the United States Department of Energy's Jim Brodrick noted that solid-state lighting standards and testing methods "may not be glamorous, but they're essential for the success of any technology, and SSL is no exception." Certainly, this is true with respect to lumen quality, and for many years, the LM-80 standard, used to measure lumen maintenance of LED packages and modules, has sufficed. However, with the growing adoption of LED technology has come higher customer awareness and expectations. "Good enough" isn't good enough anymore.

Color maintenance, another element of light quality, has also been undergoing greater scrutiny. As customers moved from halogen to metal halide accent lighting, they assumed that the color between lamps would remain relatively consistent until the lamp stopped working. However, "lifetime" was conveniently being redefined to mean lumen lifetime, not necessarily quality of light lifetime. Digging into a data sheet may have yielded an esoteric note about lumen life of, say, 12,000 hrs. and a color life of less than 8,000 hrs. But few would go to this trouble. Quality was sliced off the datasheet under the rationalization that customers wouldn't know or care. And then the lamps shifted color or failed well before expected, or, despite being rated a premium "90" CRI, it turned out that they weren't really "90" after all.

Enter "C"

The lighting industry is familiar with the convention for describing the lumen maintenance of a LED luminaire or light source. The "L" designation stands for the percentage of light output in lumens that remains at a point of time in the future, e.g., "L70" represents 70% lumens. For many applications, however, useful life is best measured not by lumen maintenance, but rather by color maintenance, and locating the color maintenance specification for an LED source can be difficult. Many manufacturers don't provide this information, or they use different notations, such as "5 SDCM" or "+/- 200K in CCT over life."

Enter the "C" notation. Devised as a simple, real-world alternative to other color maintenance specifications, the "C" notation stands for a light source's future color point, compared to its original color point at the date of manufacture, as measured in CIE 1976 color space. In layperson terms, it's a metric for color maintenance.

For example, "C3 50,000hrs" is $0.003 \Delta u',v'$, or a distance of 0.003 as measured on the CIE 1976 color space, compared to its original color point, at 50,000 hrs. The CIE 1976 color space is used because the distance between points on the diagram is proportional to the perceived color difference, which is a significant advantage. The U.S. Environmental Protection Agency (EPA) "EnergyStar" program also uses CIE 1976, and most lighting academics worldwide agree that it is the most appropriate color space to use for measuring color change.

Similar to the metric that enables customers to compare two sources' lumen life – e.g., L70, 35,000 hours vs. L90, 25,000 hours – adoption of the "C" metric provides a common yardstick for comparing the sources' color maintenance over time.

Thanks to the Illuminating Engineering Society of North America (IESNA), we have tools to back up data sheet lumen claims. These include the aforementioned LM-80, as well as TM-21, which establishes a standard way to use LM-80 data to make consistent lumen lifetime projections beyond the testing period.

For color consistency, there's no industry-accepted projection standard akin to TM-21, so some individual manufacturers use their own projection methodologies. Without a standardized color maintenance projection methodology and results, examining the warranty is the best way to determine whether a manufacturer values the source's ability to maintain color over time.

Adoption of the "C" notation will allow the industry to better move forward with educating customers on the basic aspects of light quality. It's a simple device, yet grounded in established science, and enables a true comparison of products. ■

T.S.

BICOM

Professional LED Lenses & Reflectors Manufacturer

- Develop over 100 new products monthly
- Cooperate closely with Osram, Philips, Cree, Nichia etc.
- Have rich industry experience in optics design and manufacture
- Finish a new optical design within 3 days & Trial-mould samples in 5 days
- Provide high efficiency LED Lenses, Reflectors, Tube & Bulb Covers



LED Tube Cover



LED Bulb Cover



Reflector



Multi lenses



Single lens



Streetlight lens



sales@bicomoptics.com

SHENZHEN, CHINA

TEL: +86-755-29199996

FAX: +86-755-82033711

HONGKONG

TEL: +852-39216016

FAX: +852-27837978

SHANGHAI

TEL: +86-21-33634169

FAX: +86-21-33634512

ADD: B4 BUILDING, XINJIANXING INDUSTRIAL PARK, FENGXIN ROAD, GUANGMING DISTRICT, SHENZHEN



www.bicomoptics.com

Venice Achieves Milestone in Energy Efficiency While Maintaining Beauty and Character of Historic Luminaires

All along the canal-ways and on the grounds of the famous Piazza San Marco in Venice, Italy, vintage luminaires have been upgraded to LED lighting to reduce energy usage by over 80 percent while maintaining the look and feel of a bygone era.

Venice is a city for lovers. An evening spent traveling along the Canal Grande or strolling through the spacious Piazza San Marco is typically enhanced by a warm glow from antique luminaires - which project light on the captivating waterways and stunning architecture found everywhere the eye can see. So when it came time to upgrade to a more energy-efficient lighting solution, Venetians and historians including the Commission for the Architectural and Landscape Heritage got involved to see to it that the exact lighting quality in all of Venice be preserved.

Litek, the Italian provider of lighting fixtures that was commissioned for its "Custom Service" division, decided to use Philips Lumileds LEDs within the fixtures after 4 years of testing.

"After hard tests on site, we determined that Philips Lumileds LEDs were the right choice for this project—not only for their LED capabilities, but to preserve the unique light and wonder of Venice," says Fabio Facchini, CEO at Litek. In partnering with Philips Lumileds, LITEK was able to deliver LED lighting that was 80% more efficient, yet maintained the light quality (lumen output and color temperature) of the previous mercury discharge lamp technology. Other key reasons partnership included Philips Lumileds' strong reputation, ability to co-deliver a reliable product and strong technical support.



Rialto area with luminaires

Throughout Venice, a total of 7,000 luminaires were retrofitted with LED lighting solutions. In addition to realizing an energy savings of 81.4% and the accompanying reduction in CO₂ emissions, the lumen maintenance lifetime of the LED fixtures is expected to be 50,000 hours or 5x longer than the mercury discharge lamp technology. On average, the lights are illuminated for 11 hours per day or 4,200 hours per year. The light quality has been precisely replicated, but with greater reliability and dramatically improved efficiency.

Piazza San Marco:

Simply referred to as the piazza, the Piazza San Marco was designed for people, and indeed has functioned as a social, political, and religious center of Venice for centuries. This vast public space in the heart of Venice assumed its present form during the Renaissance. "In the evenings or at night, one's perception of the notable architectural structures in the piazza, including the Basilica de San Marco, the Torre dell'Orologio [Clock Tower] and the Palazzo Ducale, is keenly affected by the lighting," says Mark van den Berg, Director of Marketing at Philips Lumileds. For this reason, it became necessary to maintain the exact light quality that was delivered by the mercury discharge lamps of the past, when they were replaced by energy-efficient LED lamps."

On the piazza, post-top luminaires were fitted with LUXEON K high-lumen-density arrays due to their high efficiency, ease of use and low maintenance, in addition to customized optics,

specifically designed by Litek. Though the initial consultation on the project began as early as 2008, installation was rapid once it started in January 2013 with all fixtures changed out by the end of April 2013. In Venice, about 6,000 post-top luminaires were changed out to warm white (3000 K correlated color temperature, CCT) LEDs with a CRI of 80.

Canal Grande, Accademia Bridge, Rialto:

The banks of the Canal Grande are flanked by 170 buildings that date back from the 13th to the 18th century. The canal forms a major corridor through the city, spanning over 3,800 meters and 30-90 meters wide, and is traveled by gondola, water bus or water taxi. Along the Canal Grande, across the Accademia Bridge and in the Rialto shopping area, a second type of luminaire has been used in the past, which also utilized halogen bulbs. The retrofit LED luminaires incorporate LUXEON M high-flux-density emitters that have been optimized for high efficiency and consistent color point.

When the project was completed, over 1,000 luminaires in these areas had been retrofit with LED emitters. A CCT of 3000 K was used with a CRI of 80.

City-wide Results:

According to the local utility, the overall lighting replacement project realized a reduction of 75 kW of power annually. The 7,000 light fixtures, which are now LED based, consume 1.4% less energy than they did previously. ■



Lit luminaires at Piazza San Marco



View to the Bridge of Sighs



Idyllic small bridge with luminaire



CREE IS LED LIGHTING

innovative LED light.

As the developer of the first lighting-class LED, we're not scrambling to adapt to change; we are the change—and we won't stop until LED lighting is everywhere. That's why Cree makes the industry's best LED components for nearly every application, from directional to distributed. **Cree makes light for living.**

CREE 

Visit cree.com/innovative and learn how our full portfolio of LED components and modules can lower your system cost.



Philips Lumileds Boosts Efficiency and Lumen Density of their COB LEDs

Just months after its market introduction, Philips Lumileds announces its LUXEON CoB arrays now provide +10% greater performance, extending their lead as the most efficient LED arrays on the market.



Philips Lumileds COB LED arrays combine exceptional beam uniformity with industry-leading efficacy

“Just one quarter into volume product deliveries, we have increased LUXEON CoB performance by +10%, which speaks for the rapid rate at which we upgrade the lumen output and efficacy of our products,” said Eric Senders, Product Line Director at Philips Lumileds. The result is superior efficacy of up to 130 lm/W and the highest combination of lumens, package density and efficacy in the industry. For instance, in warm white, the 9 mm array delivers 2200 lm at 100 lm/W and the cool white array delivers 2500 lm at 105 lm/W.

Utilizing a small light-emitting surface (LES) of 9, 13 or 15 mm, designers are able to use less expensive optical solutions, resulting in ultra-compact luminaires that deliver outstanding center beam candle power.

In addition to the optical advantage, the metal-core printed circuit board of the LUXEON CoB substrate provides 4X better heat transfer than competitive solutions, which enables up to 40% smaller heat sinks or improved reliability of the lighting system when a larger heat sink is used.

“LUXEON COB is now an even better option for a number of general lighting solutions,” said Senders. “Our 90 CRI versions have a typical CRI of 97, which makes them perfect for high Quality of Light applications. Lumen packages are available with CCTs of 2700 to 5700 K and CRIs of 70, 80 or 90.” ■

Luminus to Launch XNOVA COB LEDs

Luminus Devices, a wholly owned subsidiary of Lightera Corporation, launched its XNOVA line of high performance LEDs for professional and general lighting at the Hong Kong Lighting Fair, October 27-30, 2013.



Luminus Devices' new XNOVA brand consists of a family of LED chip-on-board (COB) arrays with a light output between 350 lm to above 10,000 lm and a CRI between 80 and 95

Main Features:

- Efficacy over 120 lpw provide energy savings in Warm White
- CRI options of 80 / 90 / 95 to meet a range of application demands
- 2-step and 3-step binning options for high level of color uniformity array to array
- Flux options ranging from 300 to > 9,000 lm

XNOVA consists of a family of LED chip-on-board (COB) arrays and emitter products designed to provide best in class, solid-state light sources for applications including professional lighting fixtures, replacement lamps, portable illumination and camera flash. Exceptional efficacy, color quality and reliability are hallmarks of XNOVA technology with performance leading today's top-tier LED suppliers.

“The XNOVA family enables further adoption of LED technology into mass markets by providing our customers with outstanding technical performance and superior value, said Decai Sun, Chairman and CEO of Luminus.” Leading lighting companies around the globe are already designing their next generation lighting solutions based on our new technology. ”

XNOVA COB arrays are offered in a range of light outputs from 350 lm to over 10,000lm with color quality (CRI) levels of 80, 90 and 95 in warm white and 75 in cool white. Typical efficacy for warm white is 120 lumens per watt; 135 for cool white. ■

Bridgelux Introduces Cost Effective V Series LED Arrays

Bridgelux has introduced a new line of Chip-on-Board LED array products called the Bridgelux® V Series™. These cost-effective light engines feature high flux density in small source size packages and are well suited for sub 1000 lm commercial and residential lighting markets where tight beam control and high quality light matter.

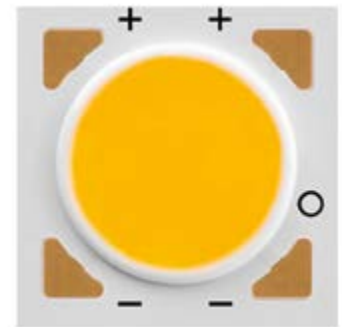

Bridgelux's new Array LED family was developed to give customers light sources in smaller packages to address a wide range of sub 1000 lumen applications

The Bridgelux V Series LED arrays were developed for sub 1000 lm applications such as PAR lamps, MR-16 lamps, small aperture down lights, landscape spots and security lights, track lights, spots, and accent lights. According to Strategies Unlimited, the worldwide LED PAR Replacement Lamp market size alone is expected to grow from 13 million units in 2011 to 47 million units in 2016.

The V Series LED arrays initially consist of two light engine sizes (V6 and V8) with multiple electrical configurations, CCT and CRI combinations, enabling greater design-in flexibility and energy-efficiencies. These light engines can be efficiently driven at twice the nominal current, which translates into enhanced system flexibility and industry leading lumen per dollar performance. In addition, the V Series LED arrays are supported by a variety of existing and new low cost mechanical holders, optics and drivers from a variety of established ecosystem partners, bringing down overall sourcing and installation costs for lower lumen applications while getting the benefit of high performance Bridgelux light source technology.

The V Series arrays have been optimized to enable a cost-effective design for LED lamps, commercial track and spotlights, consumer

down lights and other general lighting applications. They feature a low thermal resistance and an electrically isolated thermal path for simplified thermal management. They also support Energy Star and various rebate programs with more than 7,000 hours of LM80 test data and R9 values that exceed California Energy Commission requirements for luminaires and lamps. The V Series arrays also include ANSI compliant 3-step binning, reducing SKUs, while bringing consistent high quality white point light to this new segment. Like all Bridgelux array products, the V Series comes with a 5-year limited warranty. ■

Cree Extends XLamp CXA Family with 68% Brighter LED Arrays

Cree, Inc. introduces two new XLamp® LED Arrays to enable high-lumen applications ranging from wall packs to canopy lighting with one CXA LED family. The new CXA3590 LED Array delivers up to 16,225 lm at 85°C, 68% more lumens compared to Cree's previous brightest array. The CXA3590 LED Array is the ideal light source to replace 250 W metal halide (MH) fixtures—using 40 percent less power and designed to last twice as long.



With the new CXA3590, Cree again improves the lumen density of one of their COB LED arrays just one month after the introduction of the CXA1520

Cree also introduces the CXA3070 LED Array, which delivers more than 11,000 lm at 85°C and shares the same footprint and package design as the existing CXA3050 LED. Both the CXA3590 and CXA3070 arrays are optimized to simplify design and enable low system cost. The new high light-output LED arrays deliver up to 134 lm/W at 85°C and 70-95 CRI options –

expanding the industry's broadest family of LED arrays that push the boundaries of lighting-class performance by combining high quality of light with high light output and efficacy.

Characterized and binned at 85°C, the new LEDs are available in ANSI White and EasyWhite® color temperatures (2,700 K – 5,000 K), providing the industry's best color consistency for designs that use only one LED. Cree® XLamp CXA3590 and CXA3070 LED samples are available now and production quantities are available with standard lead times. ■

Cree Improves XLamp XP-G2 LEDs with Enhanced SC³ Technology™

Cree, Inc. sets a new industry benchmark with higher performance XLamp® XP-G2 LEDs. The latest innovation boasts a seven percent increase in brightness compared to the already industry-leading XP-G2 family. The new LEDs provide lighting manufacturers with an unprecedented combination of light output, efficacy and outstanding reliability, while delivering an immediate boost in performance.

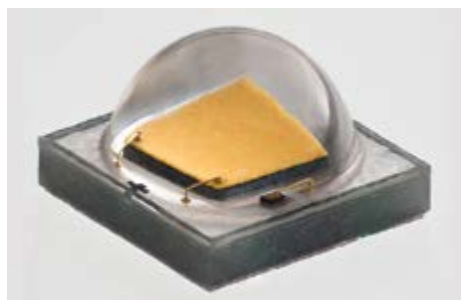

Cree's new XLamp XP-G2 LEDs are based on their enhanced SC³ Technology™ platform that drives performance up and system cost down

XP-G2 LEDs are used in a wide variety of applications, including street and area lighting, PAR replacement lamps and high-performance flashlights. The new XP-G2 LEDs now deliver up to 142 lm/W at 350 mA, 85°C or 155 lm/W at 350 mA, 25°C in warm white (3000 K), enabling lighting manufacturers to use fewer LEDs to achieve the same brightness at a lower system cost or increase performance levels using the same LED count and power.



HONGLITRONIC
鸿利光电
Stock code: 300219

Go with honglitrionic,
go with global trend

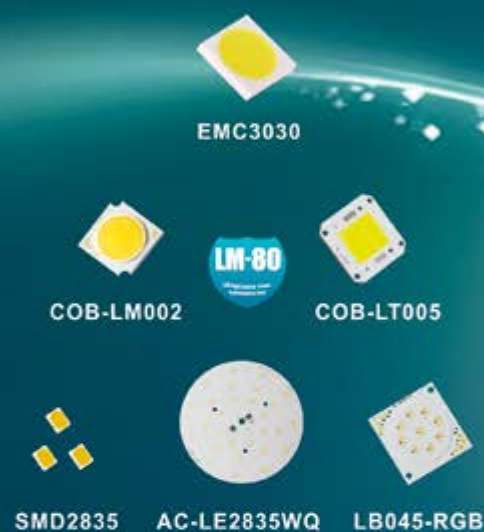

Exhibitions:

BIEL light + building Buenos Aires
(5-9 November 2013)

INTERLIGHT MOSCOW powered
by light + building (5-8 November 2013)

The leading Manufacturer of White Light LED in China



- More than 150 automatic production line, with 700KK per month production capacity.
 - As the first manufacturers in China to pass the IES LM-80
 - 13 in-house certified lab and advanced testing equipment for overall quality assurance.
- Contact: sales@honglitrionic.com

<http://en.honglitrionic.com>

Cree is also announcing the availability of 6,000 hours of LM-80 long-term testing data for the XP-G2 LED. This LM-80 data provides TM-21 reported L85 lifetimes greater than 36,000 hours, translating to a remarkable 15% light loss after four years, even at the maximum current of 1500 mA. In addition, the XP-G2's predecessor, the XLamp XP-G LED, now has more than 12,000 hours of LM-80 data available. All XP-G data sets provide TM-21 reported L95 lifetimes greater than 70,000 hours, or eight years, reflecting the excellent long-term reliability of the XLamp XP package. ■

Toshiba Launches Next-Generation GaN-on-Si White LEDs

Toshiba Electronics Europe (TEE) has announced the first devices in its second generation of LETERASTM white light-emitting diodes (LEDs) fabricated using a gallium nitride-on-silicon (GaN-on-Si) process.



Toshiba's second generation of 1 W GaN-on-Si LEDs lowers costs for general lighting and industrial lighting purposes

The 1W TL1F2 LEDs offer a cost-competitive alternative to current LED packages, allowing manufacturers of general purpose and industrial LED lighting to drive down costs.

High-performance white LEDs have typically been fabricated on expensive sapphire substrates in relatively small 100 mm or 150 mm wafer sizes. In contrast, Toshiba has developed a process that enables GaN LEDs to be produced using more cost-effective 200 mm silicon wafers. This helps to reduce costs by replacing expensive sapphire substrates with more cost-competitive silicon substrates while making use of existing silicon fabrication facilities.

Luminous efficacy of the TL1F2 white LEDs has been improved compared with the TL1F1 series by optimizing the package and increasing the optical output power of the GaN-on-Si LED chips. The TL1F2 series offers a full correlated color temperature (CCT) range from 2700 K to 6500 K, with minimum color rendering index (CRI) values of 80 and 70 respectively. Typical luminous flux of the 1 W LEDs ranges from 104 lm to 135 lm depending on color temperature and CRI.

The new devices are supplied in a standard 6450 package measuring just 6.4 mm by 5.0 mm by 1.35 mm. Typical driving current (IF) is 350 mA, with a typical forward voltage (VF) of just 2.85 V helping designers to reduce system power consumption. An operating temperature range of -40°C to 100°C makes the TL1F2 series suitable for both indoor and outdoor use in applications such as lamps, ceiling lighting, street lights and floodlights. ■

Cree's New XLamp XQ-E LEDs Deliver Big Performance in a Tiny Package

Cree, Inc. introduces the new XLamp® XQ-E LED family enabling lighting manufacturers to significantly reduce the size and total cost of their LED luminaires without sacrificing light output, efficacy or reliability. The new game-changing LED packs the lighting-class performance of the XP-E2 into a package that is 78 percent smaller. The XQ-E LED family opens up new design possibilities for a wide spectrum of lighting applications.

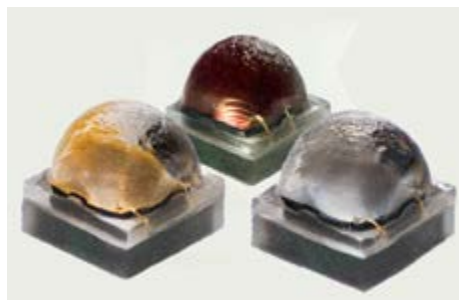

Cree's latest LED family, the XQ-E offers high lumens from a tiny 1.6 x 1.6 mm package and is available in R, G, B and W

The new XQ-E LEDs have a tiny 1.6 x 1.6 mm footprint and are available in both white and color configurations. The XQ-E's combination of optical symmetry, consistent design across

all configurations and its small size enables improved color mixing and optical control compared to the larger XP-E2 LED.

"Previously, the size of LEDs dictated the form factor of the luminaire and lighting manufacturers had to design around the light source," said Paul Thieken, director of LED Components, Cree. "With its unparalleled performance and size, the XQ-E LED redefines what's possible with lighting designs, enabling new form factors and eliminating constraints."

The XQ-E White LED is available in 2700 K to 6200 K color temperatures and offers minimum CRI options of 70 and 80. The XQ-E White LED delivers up to 287 lumens at 3 W, 85°C. XQ-E Color LEDs are available in red, green and blue. ■

TSMC Solid State Lighting Unveils TRx-series Module

TSMC Solid State Lighting pioneered the package-free LED and LED module with Phosphor-on-Die (PoD) technology in 2012. Again leading the industry, TSMC Solid State Lighting announces its release of its first package-free PoD LED product, the "TRx-series" modules. The product was launched at the 2013 Hong Kong Lighting Fair Autumn Edition, where a demonstration was made.

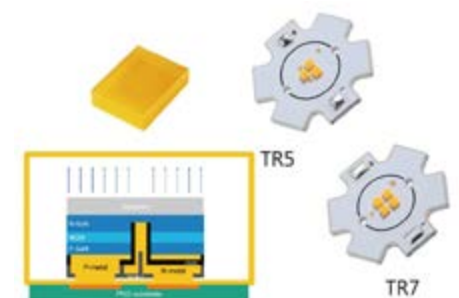

TSMC Solid State Lighting claims Phosphor-on-Die (PoD) technology to be a game-changer that maximizes value and flexibility for lighting applications

Package-free LED unit with PoD (Phosphor-on-Die) technology:

Using an advanced process, phosphor layer encapsulates the die without additional packaging, creating the emitting device. This new form of LED packaging delivers high lumen density in a tiny size, 150-degree wide viewing angles, consistent color temperatures,



Ledlink Optics, Inc.

www.ledlink-optics.com

New Product | Hybrid & COB Lens



LL01CT-AZNxxL02-P

DxH(mm) 88.5 x 15
FWHM 24° 38°
For Citizen CLL030
Cree CXA 2520
Sharp GW6DLC 25W

Holder LL01A00SUFB2



LL01CT-AZWxxL02-P

DxH(mm) 76.1 x 12.7
FWHM 24° 38°
For Citizen CLL020
Cree CXA 1512
Sharp GW6BMR 10~12W

Connector LL30A00SUNB2-M2



LL01CT-AMYxxL06

DxH(mm) 75.8 x 23
FWHM 24° 38°
For Citizen CLL030 - CLL040
Cree CXA 25xx / 3050

Holder LL30A00SULB2



LL01CR-BAYxxL02

DxH(mm) 75.8 x 22.5
FWHM 24° 38°
For Citizen CLL020
Cree CXA 15xx
Sharp GW6DLA 15W
Nichia 066

Holder LL30A00SULB2



Our Services



- ▶ R & D ▶ Precision Mould ▶ Manufacture ▶ Component solution
- ▶ Customerization

Further technical information is available, please contact us for more details.

service@ledlink-optics.com



and allows a variety of package choices at different lumen levels with high voltage building block. In addition, this new LED packaging method both simplifies the design of lighting products and makes the design of entirely new lighting products possible by removing limitations of conventional LED packages.

The new TRx-series which includes the new TR5 and TR7, is designed to meet the requirements of the traditional 25 W and 35 W equivalent MR16 lamps, respectively. ■

Oree Expands Planar LED Light Source Offerings

Oree Illumination Solutions Inc. (Israel), developer of LED-based planar lighting technology, has announced the market availability of several new products, expanding its LightCell™ Plus range to include a Quad version and an Ivory White line.

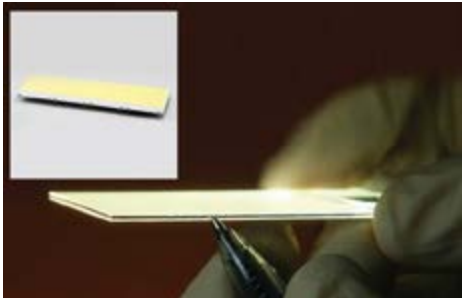

The LightCell QUAD (inset) is the latest edition to the PLUS range. Offering 1400 lm in the same ultra-thin form factor

The Quad is a larger version of the Solo and Duo LightCell products, delivering modularity for design flexibility. The typical lumen package of the Quad is 1400 lumens; the dimensions of the illuminated area are 7 x 28 cm. Other product features like thinness, CCT range and CRI are the same as those of the Solo and Duo versions.

Another eye-catching new product is the Plus Ivory White line. Contrary to the usual yellow appearance of remote phosphor products in “off state,” the new Oree LightCell has an ivory white appearance. This product is an answer to customer requests for such a color in “off state.” The Plus Ivory Line starts with the launch of LightCells (Solo, Duo and Quad) with a CCT of 3000K; 2700 and 4000K versions will follow later this year.

“This expansion of our Plus range enables our customers to utilize Oree’s planar lighting technology in a wider variety of applications,” said Dirk Pieter Smedema, VP of sales and marketing at Oree. “We expect these new products will accelerate market adoption of our technology and lead to the creation of exciting new lighting products.” ■

TALEXXengine STARK NEW DLE - High Efficiency in a Compact Design

The new generation of TALEXXengine STARK NEW DLE light engines from Tridonic not only offers a boost in efficiency from 77 lm/W to 140 lm/W but the LED downlight module in the system has an exceptionally low profile of only 20 mm. An enlarged light emission surface with a diameter of 65 mm leads to lower luminance and makes it easier to reduce the glare from downlights. Lower UGR values (UGR = unified glare rating) can therefore be achieved and the quality of light improved as a result.



Tridonic’s new generation of TALEXXengine STARK NEW DLE light engines is more efficient, more compact and offers better glare reduction

The new generation of TALEXXengine STARK NEW DLE light engines is more efficient, more compact and offers better glare reduction. The system comprising an LED module and associated converter benefits from state-of-the-art LED technology which enables more efficient and more cost-effective modules with very low profiles to be produced. In addition, the “Best LED Operation” (BLO) mode ensures that there is always the optimum balance between efficiency, lifetime and cost. A color rendering index (CRI) greater than 80 and small color tolerances in accordance with MacAdam 3 translate into high-quality light from the LED modules. Color differences are barely perceptible so the white light has an

extremely uniform appearance. The white light is available in the standardized color temperatures of 3000 K and 4000 K.

Less glare, more applications:

The light emission surface of the LED module now has a greater diameter of 65 mm. This reduces the luminance, making it easier to cut down on glare from luminaires and lighting systems. Lower UGR values can be achieved, opening up new applications which make higher demands on the quality of light. These include computer workstations, conference rooms, schools and other educational establishments. At the same time, the height has been reduced by 50% to only 20 mm. Luminaire designers now have even greater creative freedom, particularly for compact lighting solutions.

TALEXXconverter ECO (dimnable from 1 to 100 percent) and TALEXXconverter TOP (non-dimnable), 20 and 35 W, are perfectly matched to the LED modules and are available as built-in and surface-mounted versions. The appropriate lumen package is automatically configured when the LED module is connected to the converter. The luminous flux remains constant at all times, even if the color temperature changes. Different luminous flux packages (1,100 lm, 2,000 lm, 3,000 lm) are available for simple and accurate planning throughout the entire life of the light engine of 50,000 hours. ■

Stanley Released 2000 K Candle Light Spectrum LED

Stanley Electric Co., Ltd, an LED manufacturer from Japan which places “Quality of Light” as of key importance, has been the first in the world to succeed in mass-production of special candle light spectrum LEDs with a color temperature of 2000 K.



Stanley Electric’s 2000K LED has spectrum that perfectly mimics actual candle light

> TOSHIBA BRIGHTENS THE LED FUTURE

The revolutionary white LeTeras™ LEDs are based on gallium nitride chips, manufactured on 200mm silicon wafers, offering a very cost competitive solution for general and industrial lighting systems.

- GaN-on-Si technology
- Cost advantage vs. sapphire substrate
- Low power consumption and long life
- Package range from 0.2W to 1.0W

• WWW.TOSHIBA-COMPONENTS.COM/LEDS



Stanley Electric's 2000 K LED (from the 6J series) has a similar spectrum to actual candle light. With our long-standing insistence on creating the highest "Quality of Light", we have utilized our unique in-house phosphor mixing technique, enabling us to finally strike the perfect balance between high luminous efficiency and high quality which is generally thought of as particularly difficult with low CCT LEDs. Moreover, we succeeded in the stable supply of this special spectrum candle light LED through our long term efforts in production and process management.

A 2000 K LED is ideally suited as a candle light replacement which is more eco-friendly and energy-efficient. It is perfect for lighting in monuments, traditional stone-built architecture, museums, restaurants and any other indirect lighting. ■

Cree Adds "Sunset Dimming Experience" To Its LMH2 Module Portfolio

Cree, Inc. introduces the LMH2 LED Module with sunset dimming – Cree's dimming technology that provides a dimming experience similar to incandescent lighting. The new module enables a natural dimming profile that was previously unachievable with any other energy-saving technology. Cree's sunset dimming technology dims smoothly from 2700 K to 1800 K delivering rich, warm light for applications requiring a traditional dimming style such as hospitality and residential, while still achieving over 80% energy reduction compared to incandescents.



Cree now offers "sunset dimming" with the latest member of their LMH2 modules

The robust LMH2 module family now lets lighting manufacturers address a wide range of lighting technologies with a one module form factor. The aesthetically pleasing module leverages one product platform to create an entire luminaire portfolio – delivering the investment protection necessary to quickly and cost effectively address most lighting applications.

Available in a range of lumens (850 to 3000) at 2700 K and multiple driver options, LMH2 modules with sunset dimming technology can plug-in seamlessly to existing LMH2 module drivers and reflectors, and are also compatible with TRIAC dimmers—meaning the high-performance module can be easily retrofitted in any room with traditional dimming technologies or used in new installations with 0 - 10 V or Digital Addressable Lighting Interface (DALI) dimming technologies.

Designed for 50,000 hours of operation and dimmable to five percent, the LMH2 module comes with Cree's industry-leading five-year warranty. Luminaire makers seeking Energy Star® qualification will have access to specification and performance data, including LM-80 reports, which can speed regulatory approvals. ■

Xicato Broadens Artist Series® of LED Modules

Xicato announced that has expanded its Artist Series® portfolio of LED modules, adding a 2,000 lumen module to give interior designers and lighting professionals the option to offer high-quality light in general lighting applications. Installations with higher ceilings, i.e., greater than 3 m, and fewer light points can now accommodate a better grade of lighting than is possible with fluorescent or ceramic metal halide (CMH) sources.



Xicato eliminates compromise between high-quality light or energy efficiency for end users. The Artist Series® LED modules now range in flux levels between 700 and 3000 lumens and are virtually indistinguishable from halogen lamps

- Artist Series light is virtually indistinguishable from halogen-based light and gives Artist Series light an even richer feel compared to other sources.
- Vibrant Series light brings out vivid, saturated colors and the details of texture for compelling and eye-catching visuals that capture and hold consumers' attention.
- Standard Series light provides light that is functional and superior to ceramic metal halide and fluorescent lamps.

The light from Xicato's Artist Series LED modules is virtually indistinguishable from halogen, is more energy efficient, and delivers color consistency and longevity that greatly exceeds what's possible with halogen lamps. The color rendering index (CRI) is the most often used measure of light quality and the Artist Series has a CRI ≥ 95 as measured against all 15 official reference colors. Fluorescent and CMH color rendering is typically based on only eight of the 15 CRI reference colors. The Artist Series virtual match to halogen across all 15 color points is one of the many reasons the light feels more natural.

Xicato believes that the expectation for quality light should extend to ambient lighting, in addition to accent and spot lighting, and has filled its Artist Series range with flux levels between 700 and 3000 lumens. Compromising good light to achieve efficiency is no longer necessary, and end-users should no longer need to make the tradeoff. ■

Philips FastFlex LED Module Gen2 for Outstanding Performance

Royal Philips announced the introduction of the second generation of the FastFlex LED module, a lens-based LED lighting system for outdoor and industrial applications. The proposition consists of two key building blocks – a LED board and an optical lens. The core of the FastFlex LED system proposition is the modular approach to luminaire design. The same lumen package can be created using different combinations of LED module boards and drive currents, allowing luminaire manufacturers to optimize their designs for performance, value, or a balance of the two.



FastFlex LED module Gen2 offers a modular approach to luminaire design with highly efficient components

The FastFlex LED module Gen2 has fantastic LED performance, delivering 145 lm/W at 350mA. In addition, FastFlex lenses offer 96% optical efficiency and the lens portfolio has a range of beam patterns, meeting the needs of the majority of outdoor projects, floodlighting and high-bay applications. The range of optics can create a complete portfolio from a single light engine design. Outstanding optical design and module efficiency result in reduced light pollution and up to 30% energy savings compared to conventional systems.

FastFlex is designed to minimize the impact of physical forces. The patented module clip offers a unique solution to managing mechanical and thermal stresses placed on a lens-based light engine during the luminaire manufacturing process and operation in the field. The modules are mechanically ideal for hassle-free manufacturing, and can be pre-assembled for rapid production. ■

Tridonic Adds Rectangular Version to LUREON REP OLED Series

LUREON REP Rectangular is Tridonic's latest addition to its OLED product series for professional lighting applications. This extremely low-profile light module measures 200 mm x 50 mm, provides uniform glare-free white light and offers high system efficiency and excellent color rendering.



Tridonic's rectangular supplement to the LUREON REP OLED portfolio offers high CRI and high efficiency

Tridonic now offers a rectangular OLED module in its LUREON REP series to go with the existing square version. The rectangular module is ideal for desk luminaires, decorative lighting strips and pendant luminaires. Luminaire designers now have even greater creative freedom. This lighting component is

less than 3 mm thick and is equipped with either plug or lead contacts. It provides uniform glare-free neutral white light at a color temperature of 4,000 K and a system efficiency of more than 50 lm/W. Its typical luminous flux is 70 lm. The 1.35 W module also has an impressive typical color-rendering index (CRI) > 90 and small color tolerances.

Simple integration in lighting solutions:

The optics, mechanics and electronics are all perfectly matched to one another. The white diffused surface of the OLED module and the extremely small color angle shift of $x, y \leq 0.005$ create a uniform light of constant color from all viewing angles. Maximum use is made of the illuminated surface. Matching converters – available in dimmable or non-dimmable versions – provide the basis for a wide range of lighting systems including applications covering large areas. ■

Khatod Releases Exclusive Strip Lenses Performing Precise Beam Angles

Khatod's newly released Strip Lenses fit for most of the SMD LEDs & HB LEDs used to build long lighting strips. Also, Khatod offers the opportunity to test them now. On request the symmetric and asymmetric Strip Lenses can be supplied with proper aluminum extrusions - plug and play.

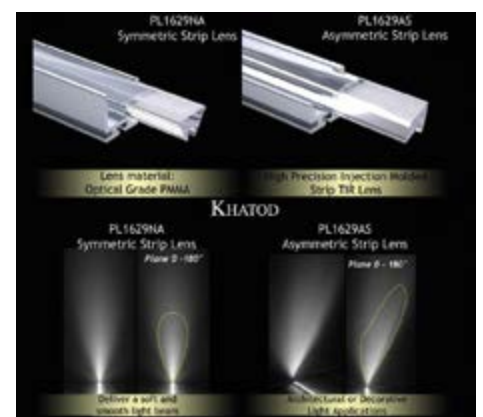

Khatod Strip Lenses are realized in 2 Beam Angles - symmetric & asymmetric

Features:

- Available in symmetric & asymmetric beams
- Efficiency $> 89\%$
- Dimensions: HxWxL = 8.5x12.5x200 mm
- Linear Pins provide robust mounting into aluminum extruded profile

The Strip Lenses are designed and optimized to suit most of the SMD LEDs used to build long strips, as well as High Brightness LEDs of latest generation from the most popular LEDs references. Also, Strip Lenses deliver excellent lighting results either with white or color LEDs.

Unique on the market, Khatod Strip Lenses are TIR Lenses manufactured through High Precision Injection Molding Process. These real TIR lenses are optically engineered to perform precise symmetric and asymmetric beam angles, are made of Optical Grade PMMA, reaching a Lighting Efficiency of 89%. The lens magnifies and directs the LED light by shaping a perfect symmetric or asymmetric beam angle, depending on the Strip Lens you are using. This gives your light more focus to a direct spot in the shape you have chosen to reproduce.

Multiples of 200 mm Strip Lenses can be butted up together to give a continuous effect, and also cut to realize desired lengths. ■

LED Driver with Spread Spectrum Frequency Modulation

Linear Technology announces the LT3795, a 110 V, high-side current sense DC/DC converter designed to regulate a current or voltage to a constant value, ideal for driving high brightness (HB) LEDs. Its 4.5 V to 110 V input voltage range makes it appropriate for a wide variety of applications.

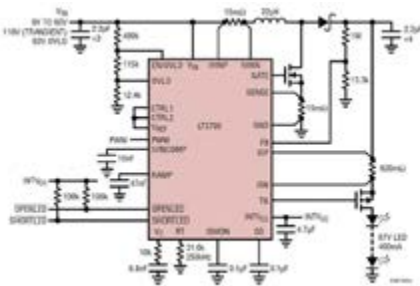

Typical application circuit using the short-circuit robust LT3795 boost LED driver with spread spectrum frequency modulation

The LT3795 uses an external low side N-channel MOSFET and can drive up to 90 W of white LEDs from a nominal 12 V input, delivering in excess of 50 watts. Spread spectrum frequency modulation reduces

EMI emissions, while an internal PMOS switch driver delivers robust short-circuit protection in boost and buck-boost topologies. The LT3795 incorporates a high-side current sense, enabling it to be used in boost, buck, buck-boost or SEPIC topologies. Additionally, it offers both input and output current limiting and monitoring for added reliability and design flexibility. The LT3795 can deliver efficiencies of over 94% in boost mode, minimizing the need for external heat sinking. A frequency adjust pin permits the user to program the frequency between 100 kHz and 1 MHz, optimizing efficiency while minimizing external component size and cost. Combined with a thermally enhanced TSSOP-28 package, the LT3795 offers a very compact HB LED driver or charger solution.

The LT3795 uses PWM dimming, which delivers constant LED color with dimming ranges of up to 3,000:1. For less demanding dimming requirements, the CTRL pin can be used to offer a 10:1 analog dimming range. Its fixed frequency, current mode architecture offers stable operation over a wide range of supply and output voltages. ■

Diodes' LED Driver Enables High PF Retrofit LED Lamps

Diodes Incorporated has announced the AP1684, a power factor-corrected AC-DC LED driver suiting a variety of offline LED lamp types, including E26, GU10, PAR and T8. Using pulse-frequency modulation technology and operating in boundary-conduction mode, this device provides tight current regulation to an accuracy of $\pm 2\%$, while achieving a power factor of .97 and THD of less than 20%.



A main feature of Diodes' new AP1684 driver is a high typical efficiency of 93%



KONICA MINOLTA

Illuminance Spectrophotometer CL-500A



- ➔ Evaluation of LED, OLED and other new-generation lamps
- ➔ Measurement of colour rendering indexes (R_a as well as R_1 to R_{15})
- ➔ Included Software (Excel Add-In)
- ➔ On-site measurement and storing of up to 100 records

Helping to significantly reduce circuit BOM cost, this primary-side driver removes the need for opto-coupler, secondary-side control and loop-compensation circuitry. Driving an external bipolar junction transistor, the AP1684 requires only a small external component count and coupled with its SO8 packaging, enables lamp designers to reduce PCB footprint, increase power density and raise overall product reliability.

The driver keeps start-up and operating currents low and uses dynamic base driver control and valley-mode switching to minimize transition loss and achieve high efficiency, typically 93%. The AP1684's circuit protection features are comprehensive and include over-voltage, short-circuit and over-temperature facilities. ■

Roal Electronics Extends Power Range of the Ozone Series LED Drivers

ROAL Electronics is launching a new, higher power Intelligent LED Driver series that are designed for directly powering LEDs in high power indoor and outdoor lighting fixtures. The Ozone 150 W Series combines smart technology, space and energy savings, and user-managed flexibility into a super compact 150 W package.



A 150 W single channel constant current LED driver extends Roal's prominent Ozone LED driver series

The Ozone is a true plug and play solution with standard features such as universal input voltage (120 / 230 / 277 Vac), active PFC > 0.9, THD < 20%, a field programmable output

current set point, 0-10 V or 1-10 V dimming. DALI communication protocol and PWM dimming ready, Ozone 150 W Series also includes 6 kV surge protection, with multiple input and output protection features.

Ozone integrates many intelligent functions, such as adjustable dimming, soft start and constant light feature, plus complimentary software and user friendly programming tools that may be used to set all of the driver's features. A dedicated case accessory enables the unit to be used in remote gear applications.

The new Ozone family of drivers comes in four models from 50 to 295 Vdc, with output currents from 200 mA to 1500 mA. ■

Amperor's New LED Driver Exceeds Features Normally Seen in LED Drivers

Amperor has announced the launch of its 150 W CC mode LED driver - ANP151. The company claims: "When our competitors promote their LED drivers, they talk about characteristics such as accepting universal input up to 277 Vac, high output power efficiency number, aluminum IP65+ case, UL certification, high build quality or competitive pricing structure. Yes, these are all the important functions to make an LED driver reliable and good. But, we don't want to make just another good 150 W LED power supply. This is why Amperor has incorporated all the above mentioned features in their "standard" design and has worked with industry leaders to include "extra" features to further enhance the driver performance."



Amperor's ANP151 150 W LED driver offers several protection features like a two-stage thermal protection, which are not common with other products

Amperor's Extra Features:

- Two-Stage Over Temperature Protection Circuitry - for better performance and protection in hot environments.
- Optional 12 Vaux Output - to drive the system vital signal measurement unit or a cooling fan.
- Optional Thermal Monitoring Port - to provide OTP based on the system PCB temperature.
- Two Case Dimension Available - fit into different shape light
- A 100 W output version available in Q4, 2013 - a more economic approach for smaller lights.

Available in two different shapes the ANP151 offers a two-stage over temperature protection circuit to prevent simple shut-off when the temperature exceeds higher than expected levels. In addition, there are optional features like a system level thermal sensing port and a 12 V auxiliary output channel integrated in the driver. ■

GEB™ Lighting Launches LED Lights that Care for Eyes

GEB™, a brand of LED light bulbs under the Aoming Lighting LLC, has recently announced their new line up of LED light that are not only environment friendly but also care for our eye sight through their newly developed lighting technology "EyesCare".



Aoming Electronic's series of LED luminaires and lamps takes care of eyes

GEB™ lamps distributed under their "Brilliant" series are smartly produced lamps that adopt a unique circuit design scheme to intelligently control and improve current flow. It uses imported chips, high color rendering index and EyesCare technology to protect the eye health of your loved ones at home especially children. The "Smart" series are lighting products manufactured at a higher level and

In electro-chemical solutions, we reign

In the formulation, manufacture and supply of conformal coatings, thermal pastes, encapsulants, cleaners and lubricants, we have the solution. Through collaboration and research, we're developing new, environmentally friendly products for many of the world's best known industrial and domestic manufacturers – always to ISO standards.

Combine this unique ability to offer the complete solution with our global presence and you have a more reliable supply chain and a security of scale that ensures you receive an exemplary service.

Isn't it time you discovered how Electrolube can serve you? Simply call, or visit our website.



Come and visit us in Hall A4,
Stand No 466, Productronica,
Messe Munchen International
12th – 15th November 2013

ELECTROLUBE
THE SOLUTIONS PEOPLE



+44 (0)1530 419600
www.electrolube.com

INDUSTRIAL@AMPHENOL
TRUSTED GLOBALLY

Amphenol LTW
Innovation in Waterproof Solution

LED Lighting Interconnect Solutions

IP66/67/68 circular connectors and interconnect accessories for power and signal distribution



Board level interconnects



Intelligent Pre-Cabling System (IPCS) for indoor and outdoor applications



Architectural lighting / LED Displays / Indoor & Outdoor General lighting

Your local sales representative:
bordan consult Ltd.
Email: Info@bordanconsult.net
Internet: www.bordanconsult.net



Amphenol LTW
LED European Business Unit Manager
Vincent Marchal
Email: vincent_marchal@ltw-tech.com



are targeted for high-end business users that require prolonged use. On the other hand, the "Saving" lighting series adopts excellent circuitry and high luminous efficacy and low luminance attenuation compared to regular LED lights. This means, brighter lamps and longer service life. ■

illumia®plus - Labsphere Improves Light Measurement Systems

Labsphere's newly designed systems build upon Labsphere's industry-leading illumia® technology with enhanced design for system modularity and innovative software capabilities. Lighting manufacturers can choose the functionality needed now, and take advantage of the flexibility to add on modules as business requirements and global standards change. Systems ship with Labsphere's mobile Integral™ LM light measurement software, allowing users to access their systems from anywhere and in any language with robust data acquisition and reporting capabilities. Also available is the API (application programming interface) capability so users can use the illumia®plus with existing software programs such as LabVIEW.



Labsphere's illumia®plus measurement system extends functionality and adds flexibility to the illumia® technology

Each base system includes a choice of integrating spheres in sizes up to 3 m and a wide range of spectrometers to meet specific applications. The newly redesigned spheres allow for tool-less switching between base-up and base-down measurement geometries and hot-swapping of stabilized lamps. Coupled with the software's automated calibration and IESNA LM-79 stabilization routines, customers can significantly decrease the length of time for each measurement and increase throughput. ■

Acal BFi's New LightSpion - Ease Light Measuring

The portable Viso LightSpion™ light measurement system, exclusive available at Acal BFi, enables you to fully measure any light source within a few seconds. Simply measure lumen, beam angle, CRI, color temperature and lumen per watt with no expert knowledge required.



The LightSpion™ even makes it easy to support new EU regulations by calculating measurements according to the required regulations via a simple click

The system is comprised of a pre-calibrated full spectra spectrometer 360-830nm and a high precision goniometer giving full 360° photometric field distribution and furthermore calculates integrated CRI, color temperature and complete luminous flux in lumens. A build in high-speed 70 K/sec sample power analyzer measures voltage and current instantly giving you precise power measurements including efficiency in lm/W.

The system comes with the "Viso Light Inspector" software that connects via USB to your computer. The user interface represents your data in clear and simple way and also allows you to drill down into the measurement's details via a simple click.

The LightSpion™ even makes it easy to support new EU regulations (EU No 1194/2012) which requires that directional lamps are measured in a 90° or 120° cone, just select 90° or 120°, and the measurements are automatically calculated accordingly.

Use your webcam or drag pictures and attach them to your measurement to make it easy manage and find your measurements. Any measurements can even be sent to any email at any time, which frees you from hassles such as loading files onto USB sticks. There simply is no lighter way to measure light than the LightSpion™.

Add your own logo and export measurement to IES, LDT, PDF, PNG, or CVS data file giving you a complete measurement solution for exporting data to technicians and lighting designers. ■

New High Thermal Conductivity LED Die Attach Adhesive

Engineered Material Systems, a leading global supplier of electronic materials for circuit assembly applications debuts its CA-195 high thermal conductivity, low cost electrically conductive LED die attach adhesive for attaching LED and other small semiconductor die to silver and copper lead frames.

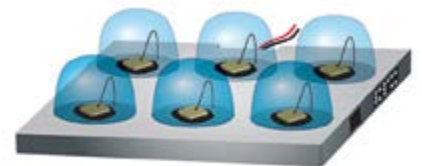

With its increased viscosity, Engineered Materials Systems' new CA-195 adhesive is particularly suitable for small die thermal management applications

EMS CA-195 is approximately half the cost of a pure silver filled die attach adhesive, has a high glass transition temperature (Tg) to facilitate wire bonding small die, low extractable ionics and high adhesion to silver and copper lead frames. CA-195 has a dispense open time greater than 24 hours (measured as a 25 percent increase in viscosity), while maintaining optimized rheology for pin transfer or needle dispensing. The adhesive is ideal for small die thermal management applications.

CA-195 is the latest addition to Engineered Material Systems' extensive line of electronic materials for semiconductor, circuit assembly, photovoltaic, printer head, camera module, disk drive and photonic applications. ■

Multi-Level PWM to Improve LED System Efficiency

LED light bulbs can be brighter and more energy efficient than ever, thanks to a new driver that powers LED light bulbs with an innovative approach called multi-level PWM (Pulse-Width Modulation), which delivers remarkable improvements in terms of light quality and energy efficiency, when compared to pulse width modulation and linear driver approaches currently used in LED products. This approach is not limited to LED drivers and offers additional advantages and options over conventional PWM or constant current mode.

By traditional method of pulse width modulation, LEDs are fed pulsed current instead of steady DC. The drive current is turned ON and OFF at a rate faster than being perceptible by human eyes. Powering LEDs in pulses makes their light output easily controllable.

The research team, formed by Dr. Lai Yuk Ming, Dr. Loo Ka Hong and Prof. Michael Tse, gives the PWM method a new twist. The pulsed operation is redesigned in a way to maximize light output while minimizing wasted energy in the form of heat. The result is higher lm/W. Dr. Hong said they achieved additional energy saving by up to 15%.

When used in a large scale application, it can save a lot of energy. The LED billboard on Times Square in New York is a good example.

The math goes like this:

The giant display uses 12 million bulbs and 250 KW of power. If the billboard is on for 16 hours a day, the energy bill comes to US\$18,000 a month. A 12% drop in energy consumption means US \$2,160 in energy savings.

Furthermore, it has lowered cooling requirements and needs a smaller sized heat sink compared to conventional methods. That means LED systems can be made smaller. With excellent dimming capability, the new MPWM driver allows manufacturers to create fully dimmable LEDs, which can be dimmed down to 0 watts of power. These superior qualities pave way for brighter, smarter and more versatile LED lighting solutions.

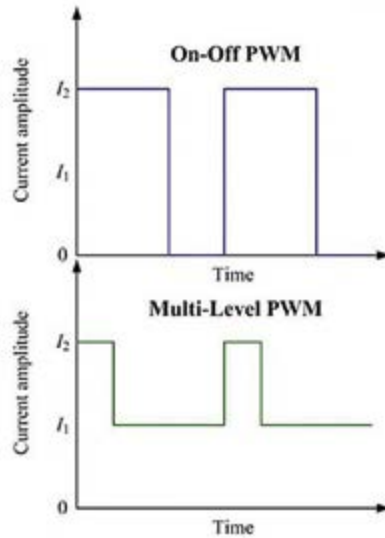

The award winning high-efficiency technology can be applied in many areas and promises up to 15% energy saving

If all the traditional light bulbs in the world were replaced with energy-saving ones, lighting energy use could be cut by 40%, according to Worldwatch Institute. The Energy Saving Trust has similar projections, which said the resultant carbon saving would be the equivalent of taking 70,000 cars off the road.

As the greenest alternative to incandescent lamps, LEDs are a popular choice of lighting but they are not perfect. Consumers are looking for a brighter and more natural glow matching up to incandescent light bulbs. The demand for brightness is even more pronounced in high power applications such as automobile headlights and architectural lightings. LED research worldwide is looking to build a perfect substitute to incandescent. It is exciting to have advanced LED lighting with a simple solution such as MPWM that brings about significant energy saving.

Obviously, the novel technology allows a better product to be made. High illuminating performance combined with good thermal protection allowed manufacturers to create compact lighting solutions with a very high lumen output. And the additional cost is little because all of these qualities could be achieved with the use of low cost ICs.

This innovative applied technology has already aroused the attention of the international market. Recently it has won a Gold Award at the 41st Int. Exhibition of Inventions of Geneva in April 2013. ■

B MADE IN GERMANY.

AQUALUC®
BRAVING ALL ELEMENTS



POLYURETHAN GROUTING FOR LED STRIPES

PROTECTS WELL AGAINST WATER, HEAT,
SAND, SALT, CHEMICAL SUBSTANCES AND
MECHANICAL STRESS

VARIOUS KINDS OF GROUTINGS
FOR VARIOUS APPLICATIONS AVAILABLE

Barthelme
LED Solutions®

www.aqualuc.de

Los Alamos National Laboratory: Dramatic Improvements in QD Technology

Dramatic advances in the field of quantum dot light emitting diodes (QD-LEDs) could come from recent work by the Nanotechnology and Advanced Spectroscopy team at Los Alamos National Laboratory.

The new research aims to improve QD-LEDs by using a new generation of engineered quantum dots tailored specifically to have reduced wasteful charge-carrier interactions that compete with the production of light.

“QD-LEDs can potentially provide many advantages over standard lighting technologies, such as incandescent bulbs, especially in the areas of efficiency, operating lifetime and the color quality of the emitted light,” said Victor Klimov of Los Alamos.

Due to spectrally narrow, tunable emission, and ease of processing, colloidal QDs are attractive materials for LED technologies. In the last decade, vigorous research in QD-LEDs has led to dramatic improvements in their performance, to the point where it nearly meets the requirements for commercial products. One outstanding challenge in the field is the so-called efficiency roll-off (known also as “droop”), that is, the drop in efficiency at high currents.

By conducting spectroscopic studies on operational QD-LEDs, the researchers have established that the main factor responsible for the reduction in efficiency is an effect called Auger recombination. In this process,

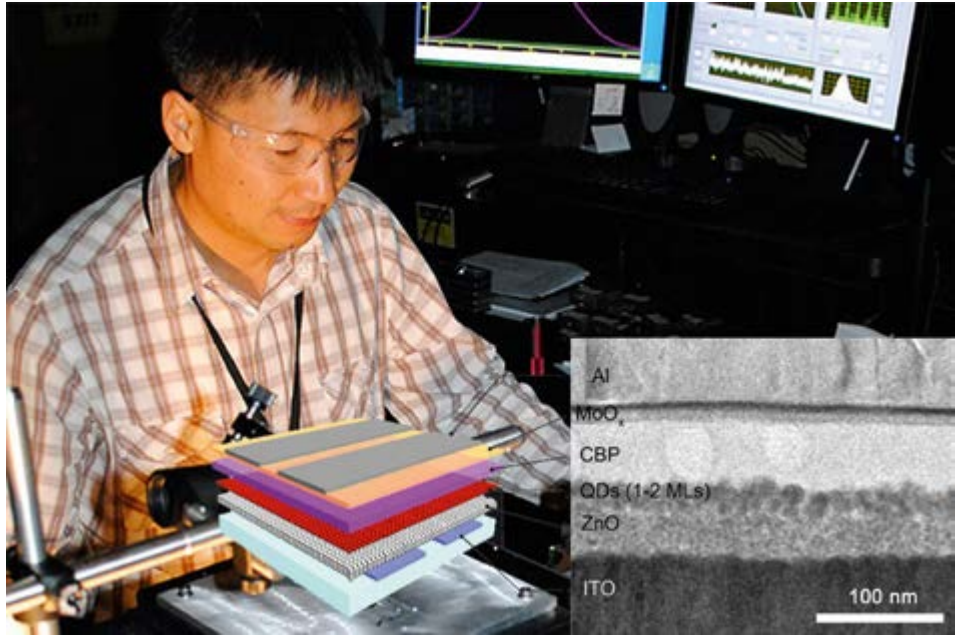

Postdoctoral researcher Young-Shin Park characterizing emission spectra of LEDs in the Los Alamos National Laboratory optical laboratory. Inset: The quantum dot device structure shown with a transmission electron microscopy (TEM) image of a cross-section of a real device

instead of being emitted as a photon, the energy from recombination of an excited electron and hole is transferred to the excess charge and subsequently dissipated as heat.

Not only has this work identified the mechanism for efficiency losses in QD-LEDs, Klimov said, but it has also demonstrated two different nano-engineering strategies for circumventing the problem in QD-LEDs based on bright quantum dots made of cadmium selenide cores overcoated with cadmium sulfide shells.

The first approach is to reduce the efficiency of Auger recombination itself, which can be done by incorporating a thin layer of cadmium selenide sulfide alloy at the core/shell interface of each quantum dot.

The other approach attacks the problem of charge imbalance by better controlling the flow of extra electrons into the dots themselves. This can be accomplished by coating each dot in a thin layer of zinc cadmium sulfide, which selectively impedes electron injection. According to Jeffrey Pietryga, a chemist in the nanotech team, “This fine tuning of electron and hole injection currents helps maintain the dots in a charge-neutral state and thus prevents activation of Auger recombination.”

These studies at Los Alamos National Laboratory were funded by a grant from the U.S. Department of Energy Office of Science. ■

WEBINARS



Obtaining the Highest Candle Beam Power for Spotlights

Lumen density in the LED source is very significant in final design. Obtaining Center Beam Candle Power is a goal in high quality applications including retail and architectural lighting. High Power LEDs are the perfect solution to creating high lumen intensity from a very small light emitting source. Creating a very high lumen per mm square enables the highest center beam candle power in a system. Where other COB's need ~35-35mm for high lumen packages, LUXEON S5000 can achieve 8000 lumens in a Light Emitting Surface of just 17mm. Creating great spotlights has never been easier.

To view the webinar, register at www.led-professional.com/Webinars

**PHILIPS
LUMILEDS**

DIMMER FOUND DRIVER!

A PERFECT MATCH – THE DIMMER
THAT FITS THE LED POWERSUPPLY



REPO1 – DIMS THE LIGHTS JUST THE WAY YOU LIKE IT

- ELECTRONIC POTENTIOMETER FOR 1-10V BALLASTS
- ZERO STANDBY CURRENT
(INTEGRATED ON/OFF SWITCH)
- ADJUSTABLE MINIMUM LIGHT LEVEL
- UP TO 10 LED DRIVERS WITH ONE DIMMER

RACD45A & RACD60A – MORE THAN JUST TURNING ON THE LIGHTS

- 3 IN 1 DIMMING (PWM/ANALOG/RESISTIVE)
- INPUT VOLTAGE 90 – 305 VAC
- IP67 RATED
- UL8750 CERTIFIED
- 5 YEAR WARRANTY

LpS 2013 - A Comprehensive Program, Trends, Innovations and New Product Launches

The 3rd annual LED professional Symposium and Exhibition (LpS 2013) took place in Bregenz, Austria on September 24-26, 2013. Arno Grabher-Meyer from LED professional summarizes the latest trends in LED and OLED lighting technologies which were presented in multiple sessions, workshops and the exhibition by research institutes, lighting organizations and the lighting industry.

The LpS consisted of a conference with 46 presentations, 6 workshops, 2 tech-panels, and an exhibition with 80 international exhibitors in a 2,000 m² exhibition area. More than 1,100 people came from all over the world to take part.

Keynote speaker, Dietmar Zembrot, President of LightingEurope said, "I think this is one of the most important lighting events in the world". Positive feedback like this confirms the value of the event for the lighting industry. According to the event survey, up to 93% of the visitors will be attending the LpS event in 2014. Almost 60% of all visitors were from manufacturing companies, over 10% were from distributors, about 8% came from engineering and design services and around 5% came from universities. The largest percentile of visitors was made up of executive and corporate managers (20%), followed by research and development engineers (17%), then distributors and sales people (14%) and finally, application engineers (4%).

Synoptic View of the Offered Activities

The event consisted of two parallel tracks plus two optional workshop tracks and the exhibition. The conference tracks were broken down into sessions so that the visitors could visit the exhibition without missing important presentations. The 46 lectures given by international experts were covered in 16 sessions titled: Light Sources I-IV, LED Future I, LED Systems I-II, Driver & Controls I-IV, Optics I-II, Thermal Management I-II and Applications I.

Tech-Panels in which ideas about future trends and lighting solutions were discussed with industry leaders and visionaries were open to the public. The in-depth technology focus and quality of the presentations have become highly valued trademarks of the event. Intense discussions between CTO's, research and development engineers, project managers, engineers and manufacturers took place throughout the event.

The workshop program was noticeably extended compared to last year. This year, six workshops were offered in two parallel tracks on specific LED technology topics. The subjects of Reliability and Thermal Testing, Standardization, 3-Dimensional System Designs and Optics, Printoptical Technology, Computer

Supported Design of LED and OLED Systems as well as Qualification and Reliability were discussed and explained in an interactive environment.

This year the Tech Panels were open to the public for the first time. Dietmar Zembrot (President of LightingEurope and CEO of TRILUX), Klaus Vamberszky (Executive Vice President of Technology at Zumtobel), Christian May (Head of Business Unit Lighting and Flexible Integration at Fraunhofer), Nicola Trivellin (Researcher at the University of Padova) and Henk Veldhuis (Chair of the Technical Advisory Working Group of the Connected Lighting Alliance) discussed "LED & OLED Lighting Innovations- How to Break Through" on September 24th. On September 26th, the international press discussed "Lessons Learned" to wind up the symposium. In order to make the Tech-Panels even more interactive, they were broadcast live online and viewers from around the globe were invited to submit questions.

There were several new product launches presented in the exhibition: Cree, for example, launched the first high-performance LED array with an improved level of lumen density to challenge intensity and light quality of ceramic metal halide (CMH) lamps at up to 50 percent lower power.



Figures 1-5: Discussions between experts during the tech panels, the comprehensive sessions, works-hops, at the individual booths or in the relaxed atmosphere of the fringe events were characteristic of the 2013 event

Figures 6 & 7:
During the session breaks the exhibition visitors were joined by the attendees who were eager to view the latest products displayed by over 80 exhibitors

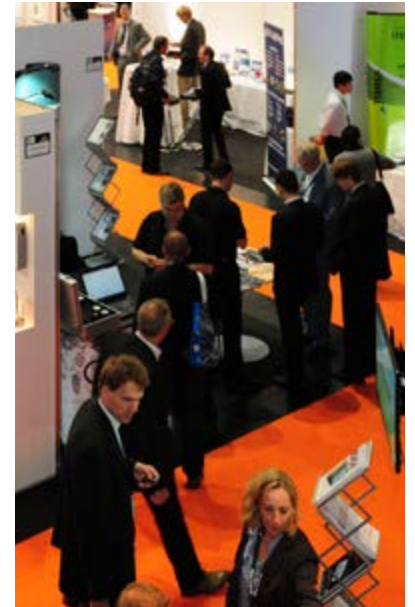

Barthelme showed the latest products, which – for the first time – used Bayer MaterialScience’s encapsulating material with properties especially adapted for LED lighting issues.

GL Optics from Germany and Allied Scientific Pro from Canada showed new products for light measurement that intend to blow away the borders between laboratory and field measurement equipment. The handheld spectrometer GL SPECTIS 5.0 touch, displayed by GL Optics, enables mobile spectral light measurement with laboratory accuracy. The device uses the Android system and is designed for advanced measurements such as photo biological safety testing of LED

products in accordance with EN 62471 or measurements of LEDs in accordance with CIE 127:2007. Allied Scientific Pro also showed an interesting measurement innovation: The Smartphone Spectrometer for LED Testing. This spectrometer is designed for on-location measurement and can be used with different versions of the iPhone, iPad or even iPod. The rapid report generation device is made for CRI, spectrum, C.I.E 1931, C.I.E 1976, Illuminance/LUX. opsira presented its Robogonio, which demonstrated how the robot-goniometer can simplify luminous intensity distribution measurements. Goniophotometers measure the spatial distribution of light visible to the human eye at a specific angular position.

This year the event qualified as a “Green Meeting” event and so, after registering, cardboard cases were given out instead of cloth or plastic bags. The cases contained the printed proceedings booklets as well as several LED related magazines and information on the city for those who were in Bregenz for the first time.

The fringe activities in the evenings offered perfect opportunities for networking in a relaxed atmosphere. On the first evening Zumtobel presented a Light Art Project at the Vorarlberg Museum and on the second evening there was a cruise around Lake Constance with dinner and live entertainment.

Figure 8:
Dinner and live entertainment aboard the MS Vorarlberg provided a relaxed atmosphere for networking



Figure 9:
The interactive and hands-on workshops got excellent feedback from the participants



Hands-On Workshops

The workshops offered detailed analyses in the areas of Reliability and Thermal Testing, Standardization, 3-Dimensional System Designs and Optics, Printoptical Technology, Computer Supported Design of LED and OLED Systems as well as Qualification and Reliability.

On Day 1, Mentor Graphics offered a workshop titled “Reliability & Thermal Testing”. The workshop explained how the junction temperature depends on both the LED package and the system on which it is mounted. Attendees learned how thermal performance of LED packages and systems can be measured and characterized for reliability improvements.

A big part of day 2 was host to the LPKF and Essemtec workshop on 3-Dimensional System Designs. Participants got a complete overview of an innovative production process for creating three-dimensional LED layouts for a wide variety of lighting sources (SSL, automotive lighting, etc.). Each LDS (Laser Direct Structuring) process step from the selection of thermally conductive materials, functional LDS coating of

the heat sink, laser structuring, dispensing of glue or solder paste for fixing the LED on the substrate to the final 3D placement of the LEDs on components was discussed.

Following that in the afternoon, there was a workshop entitled “Printoptical Technology” presented by LUXeXcel. Printoptical technology makes it possible to produce 3-dimensional optics with which lenses and light distribution structures are made. The changes in the lighting industry that this new production technology brings were discussed.

The last day of the symposium hosted the “Design Workshop” from Arrow, NXP and Transim. Deep-seated knowledge in the areas of component data and system elements such as cooling devices, optics and electronics that is needed for the design of LED lighting systems in order to be able to attain the necessary light requirements were discussed. Participants got an overview of modern simulation and configuration tools that are designed to improve R&D performance, quality and costs processes.

Cree ran their workshop on the subject of “Testing” on Day 3. “The Cree-Workshop was good, it was very hands-on! Often workshops are just lectures, but here it was quite interesting to do something in real life”, said a workshop attendee from Norway. This was a discussion of step-by-step improvements of an existing luminaire design. Participants learned how to differentiate and make use of several experimental runs based on CREE TEMPO test results to optimize their luminaire design process.

Technology Insights

Dr. Heinz Seyringer, EPIC Director, summarized his personal six highlights from lectures in his report for the European Photonics Industry Consortium (EPIC). One of the lectures he mentioned was from Annetta Kelso from Philips Lighting OEM, in The Netherlands, about “Technology Push, Market Pull, Keeping a Sense of Proportion”. The presentation was about LED transformation in the lighting market with the main emphasis on the professional business-to-business lighting market incorporating project business and trade. Kelso showed how the introduction of LED

technology changes the market and opens new opportunities as well as new threats. With LED light sources there are some general observations that can be made so far: Any LED light engine, based on a platform that is quickly outdated or requires changes with every upgrade, will be harder to sell in large volumes and is prone to generate irritation. Also, LED light engines with specifications outside of market needs or norms will cause frustration. Furthermore, LED light engines or luminaires that are overdesigned and/or adding functionality that is not needed in a certain application are tempting but at the same time a failure in a market that is extremely cost sensitive. Therefore it is of great importance to create innovations that make sense based on a deep understanding of market needs and not innovation for innovation's sake. It is all about the correct combination and cooperation of technology staff and marketers.

The presentation "OLED Module Technologies for Professional Lighting Applications" from Joerg Amelung, Tridonic Dresden gave a good overview of the technology, development, current status and applications of OLEDs. A very innovative example shown was an OLED luminaire where the front side of the device could be used as a mirror when switched off. Currently OLED solutions are mainly applied in the field of decorative lighting. To reach the professional lighting applications, OLEDs have to improve in technical parameters and cost aspects. In addition, Amelung pointed out that an OLED solution needs a thin converter. Thick converters used in traditional lighting solutions would reduce integration possibilities significantly.

David Nauth from Intematix talked about "Advancing Remote Phosphor Technology". He demonstrated that general lighting has implemented remote phosphors beneficially to lower costs and to address issues of glare, consistency and performance present in conventional white LED lighting. The quality of light is

measured in 3 key areas, Color Rendering Index (CRI) 0 to 100 (the sun is 100), Correlated Color Temperature (CCT) 1850 – 6500 K, and uniformity (Intensity: consistent brightness over angle and illuminated area, Color over angle (COA) and even CCT over angle). Remote phosphor addresses all three better than conventional white LEDs. The advantage of remote phosphor is that it is based on recycling and converting more blue photons to white light. The direct result is the need for fewer LEDs and therefore less power and producing less heat. Less heat on the other hand means better stability and longer life times. In addition, it offers more flexibility since the color temperature of a luminaire can be changed simply by changing the remote phosphor plate. The current remote phosphor solutions have an improved white off-state appearance and are no longer yellow in the off state.

"Optimized Devices for Lighting Applications" was the topic of Shawn Keeney from Cree who explained that for anyone designing a luminaire or lamp using LEDs, choosing the best device for a specific lighting application can be quite a daunting task. Dozens of manufacturers from around the globe offer a plethora of LED package types ranging from magnitudes of 10^{-3} to 102 Watts of electrical power. When faced with making this decision, there are a number of critical factors affecting the performance that must be considered and weighed against cost. These include luminous flux, luminous efficacy, optical source size, chromaticity, color rendering, thermal resistance and perhaps, most importantly, long-term reliability. In the presentation, Shawn Keeney discussed in great detail why each of these parameters is critical and how to determine the type of LED that is best suited for various example applications such as outdoor area lighting, A19 style replacement lamps, directional lamps and linear luminaires.

The lecture "LED Light Sheet Technology as an OLED Alternative" from Uwe Hock, from Cooledge

Lighting consisted of two parts. Uwe Hock discussed their new flexible lighting system and in the demonstration he showed the actual system with and without diffusers. The Cooledge light sheet combines the mechanical, electrical and LED source together into a flexible sheet of light. Basically, it consists of LED arrays with a pitch of 7 mm or 12 mm put on a flexible substrate which could also be cut at certain length intervals. If a diffuser is put above the light sheet, you get a very homogeneous light source that is flexible like a flexible OLED. However, there is a price to pay for this homogeneous illumination: depending of the LED pitch the thickness of the entire system increases to ~1.2 cm respectively ~2.5 cm. If this thickness is no problem in the application, you get a homogeneous and flexible light source.

Heinz Seyringer also found that the lecture "Dimensions of Light Quality in LED Spot Lights" held by Ralph Bertram from OSRAM Opto Semiconductors covered an increasingly important topic. Mr. Bertram demonstrated that dimensions of light quality are multiple: a rich color spectrum enables good rendering of object colors but there should be no color variations visible. There shouldn't be any difference in color between lamps. In spot-lights the beam shape must fit the illuminated objects. Tight beam angles are a special challenge for LED solutions. Last, but not least, the luminaire itself should be aesthetically designed. At the same time thermal and optical challenges need to be considered. In the presentation these points were discussed in great detail. The discussion of the color quality, for example, included which impact an optimization on energy efficiency would have on the color quality or which impact the different color temperatures have. The discussion on color consistency not only included the usual binning but also alternatives like mix-to-match where LEDs with different CCTs are combined to get the target color temperature.

Figures 10-13:
The comprehensive sessions and tech panels were well attended. Speakers and panelists alike impressed and inspired the audiences with their profound knowledge

Most popular presentation was the lecture from Matteo Meneghini, Professor at the University of Padua and member of the LpS Advisory Board, about "Degradation Mechanisms of High Power LEDs". He reported on the key findings of his study on the main mechanisms that lead to degradation of high power LEDs. Together with his team, he carried out extensive reliability analyses on two different types of commercial white LEDs. In order to analyze the effects of operating current and storage temperature on the electro-optical properties of these devices, different stress tests were performed for several thousand hours. The results presented highlight the role of operating conditions in limiting the reliability of commercial white LEDs. He found out that both the current levels and the high temperatures are involved in various types of electro-optical degradation mechanisms. Temperature may induce modifications of the blue semiconductor chip, a darkening of the package, or the degradation of the plastic lens of the devices. Furthermore, he mentioned that the combined exposure to temperature and current levels may lead to significant optical power decay due to the generation of non-radiative defects in the active layer of the chip.

Among other journalists, Mark Hattersley from the lighting magazine *mondo*arc*, wrote his impression of the event: "The variety of subjects covered in conversation during the event is refreshingly broad and yet focused. Lectures cover topics from LED failure management to the advance and alternatives to OLED applications, from the thermal behavior of bulbs to manufacturer responsibility in creating biologically friendly luminance. The conference is an ideal match for what was on show at the exhibition. Importantly, the topics hit resonance on a global level, providing experience from authorities in Europe, Asia, and the Americas. It is easy to imagine everyone - visitors and exhibitors alike - leaving with something to consider and perhaps implement into their area of the industry – and surely that is the *raison d'être* for events like this."



Trends and Innovations

Over 80 exhibitors from all over the globe showed their latest innovations, products, equipment and services in the 2,000 m², sold out, exhibition hall.

Underwriter Laboratories, Gold Sponsor of the event, presented their testing and approval services. Silver sponsor Tridonic and Lanyard sponsor Harvard Engineering showcased their competence in the field of electronic drivers while Pen sponsor Osram Opto Semiconductors, highlighted their latest LED technologies.

Two exhibitors reported having direct sales in Bregenz. Konica Minolta received two signed contracts for two measurement systems presented while the second exhibitor, working in the field of supplementary components, sealed a deal for 250,000 Euros.

There were so many innovations and trends on show that they cannot all be listed. The following are just some examples representative of the numerous products and services presented.

Trend 1: Transition to the super system

Single devices are increasingly being combined into poly-systems. Cree from the U.S.A., for example, launched their new CXA LED Arrays. These are the industry's first High-Density (HD) LED Arrays. According to Cree, this technology doubles the system intensity of spotlights compared to previous arrays. The LEDs placed on ceramic based PCBs are packed more densely and enable lighting manufacturers to create a new generation of products that delivers the same light intensity and quality at up to 50 percent lower power. Another example is Itswell from South Korea who presented their new LED Array L5256 Series for the general lighting market. The next integration step from arrays into modules and finally standardized modules could be obtained as well. For example, the Italian company

LightCube, a spin-off from the University of Padua, provides know-how and the technology for solid-state light source designs ending up in all-in-one modules. The market is seeing an increased number of modularization and especially standardized modules (e.g. Zhaga). Multiple companies deliver Zhaga compliant system components for modules. One example is AAGStucchi from Italy who manufactures holders. The distributor, MSC, from Germany showed fully integrated lighting solutions with Zhaga compatible modules and snap-in reflectors.

Trend 2: Increasing controllability, degree of completeness and elimination of human involvement

Symposium-lectures as well as technologies shown at the exhibition are following the trend of digitalization. Dietmar Zembrot said, "LEDs and OLEDs together with sensors and innovative lighting controls will enable the industry to build intelligent lighting systems with a higher customer benefit. Even beyond energy efficiency cost and usability will be a key success factor." Semiconductor light will finally be driven and controlled from "fully-digital" environments. Companies, such as ams and Tridonic from Austria, Harvard Engineering from the United Kingdom, TCI from Italy and RECOM from Germany, offer sensors and drivers for these purposes.

Self-controlled and self-adjustment systems are in preparation and will be part of next generation products.

Trend 3: Increasing degree of trimming, optimization of flow

Due to the cost pressure on LED lighting systems this trend will become a key driver for new developments. COB technology with its elimination of LED packages was presented by a number of companies.

The trimming trend can be obtained in the field of LED drivers as well. AC LEDs (shown by Neumüller/SSC)

and also single-stage topologies driver concepts (Recom, ON Semiconductor) offer systems solutions with less or no converter stages to reduce costs and losses. CeramTec, manufacturer of ceramic materials and products, eliminates heat barrier for the thermal management design. They have improved their materials and found enhanced heat conduction solutions, enabling high power applications. marulaLED from South Africa showed their innovative Cool Tube Technology, which is an active cooling system that allows the production of modules with high luminous power and compact designs for high and low bay lighting. Amphenol LTW presented a connector system to eliminate wiring and soldering for LED boards. The benefits of this system are simplified production as well as safety and reliability.

Trend 4: Increasing coordination

Tridonic launched their new LED Control Gear portfolio at the LpS event. The analogue/PWM controlled drivers, to increase controllability and coordinating signals, are available in 20 W, 35W and 65 W. TCI presented and offers custom specific LED drivers for non-standardized lighting solutions. Recom increased their driver portfolio in regards to power range and presented housings with smaller form factors. They displayed their driver competence with their new phase cutting dimmer for standard housing installations and a solar driven street lighting concept.

Trend 5: Increasing Dynamization

Bayer MaterialScience and Evonik, both from Germany, showed diffuser foils and optical materials for lenses. Bayer Material Science adapted their encapsulating materials to fit the needs of LEDs, available in transparent, colored or opaque. The material shows good optical qualities, is particularly weather-resistant, robust and yet flexible and is therefore widely applicable.

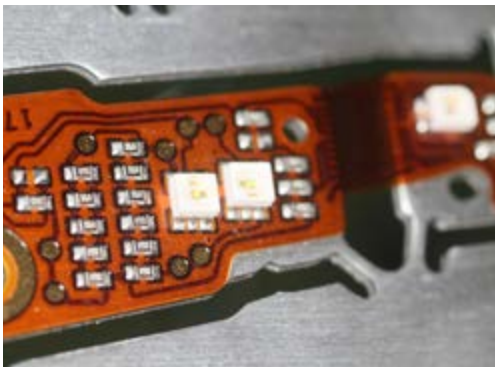
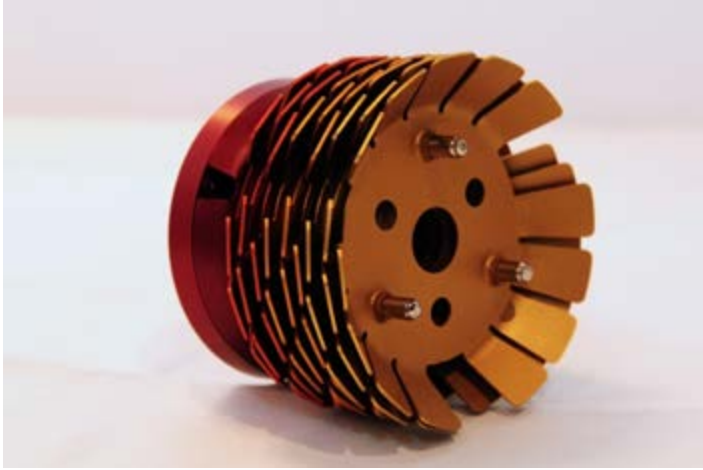

Figures 14-19: Innovative products from modules to heat sinks, PCBs, connectors, raw materials and measurement equipment were shown in the exhibition. Some of them were demonstrated for the first time.

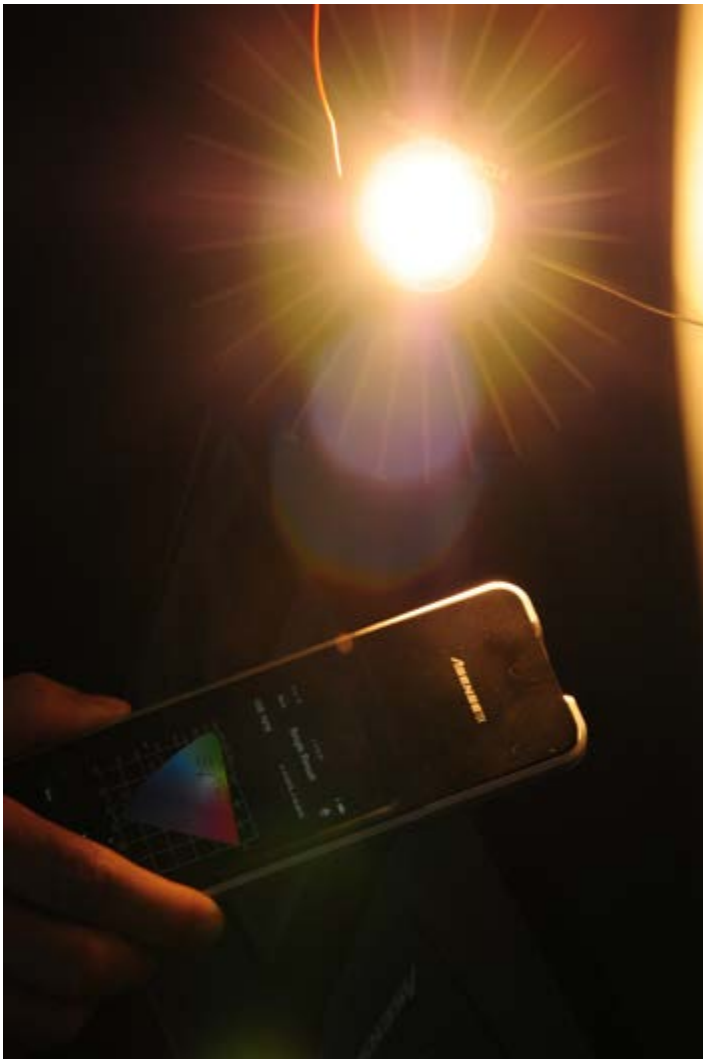
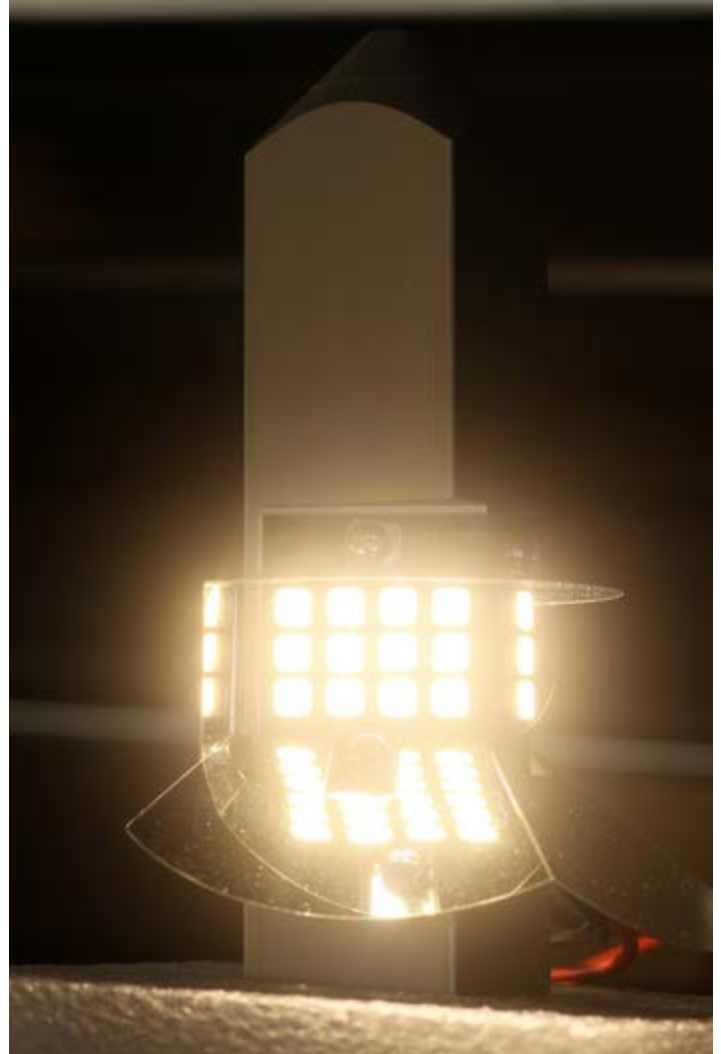

Premieres included GL Optic's GL Spectis 5.0, Cree's CXA 1520, Amphenol's solderless replacement lamp connector system and Allied Scientific Pro's smartphone spectrometer

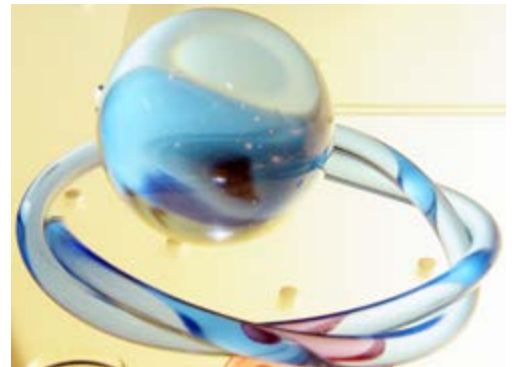

Figures 20 & 21:
Two good examples of product evolution: marulaLED downscaled their cooling concept for MR16 like form factors (top) and Seoul Semiconductors improved the Acriche II module specifications step by step (below)



Revolution Is Over – Evolution Is Now

The closing Tech Panel summarized the current trends and perceived innovations of the event. The three panelists agreed that the lectures as well as the presented products and innovations at the LpS 2013 demonstrated that the basic work is already done.

LED products have reached very high efficacy and remarkable light quality within an amazingly short time, but a lot of fine-tuning has to be done in the years to come. The industry knows this and the results are improvements throughout the whole product chain. Driver and supplies are improving in efficiency and becoming more compact. New driving concepts also improve light quality. Thermal management also hits new levels with products that allow the direct attachment of LED dies and components to the heat sink. Optics manufacturers take care of visual comfort and offer special light distribution without compromising optical efficiency.

One especially interesting trend is the smart lighting/controls approach with its many opportunities from additional energy saving to well being due to adaptive light. The major question that remains with this technology is how the market will accept it. Maybe this question will be answered at the LpS 2014 from September 30th to October 2nd, 2014, in Bregenz. ■



LpS 2014 - CALL FOR PAPERS & CALL FOR WORKSHOPS

Both Call for Papers and Call for Workshops end on February 17th, 2014.

All proposals sent by the deadline will be evaluated by the LED professional Advisory Board. The selection is based on objective criteria and formal requirements published on the LpS 2014 website. Submissions have to be sent using the submission forms provided on the LpS 2014 website. For additional information, details, deliverables, and further deadlines, or to submit your proposal, please visit: www.LpS2014.com/call or contact us at symposium@LED-professional.com



LpS 2014

LED SYMPOSIUM
professional +EXPO

OPEN NOW!
Call for Papers
Call for Workshops

END ON FEBRUARY 17th 2014



LED & OLED

Lighting Technology

SEPT 30TH - OCT 2ND 2014

BREGENZ | AUSTRIA

info@lps2014.com | www.lps2014.com

powered by Luger Research e.U.

Light Quality and Standardized Measurement

GL Optic released a new product called the Spectis 5.0 at the LpS 2013 in September. Arno Grabher-Meyer from LED professional took the opportunity to get a demonstration and an interview with Mikolaj Przybyla, brand director, and Michael Gall, CEO of GL Optic and Just Normlicht GmbH. They talked about the challenges of LED measurement and LED measurement standards.

Figure 1: Accurate measurement is mandatory in order to detect color shift over time as a result of the aging process. The figure shows an example out of the latest DOE SSL GATEWAY Demonstration Report on Color Stability of LED Lighting Products

LED professional: GL Optic is a part of Just Normlicht GmbH, a renowned manufacturer of lighting products for digital and analog photography or color inspection. I believe that you dealt with light measurement there but how and why did you become a manufacturer of LED light measurement instrumentation?

Mr. Gall: In fact, as manufacturer of lighting products we have been dealing with light measurement for over 30 years now. We have acquired a great amount of knowledge on the subjects of lighting, color control and measurement tasks over the years. However, when we designed the first LED based products like our viewing booths, we faced the tough requirements and challenges of LED measurement.

When designing a tunable LED light booth we had to deal with parameters and issues that we were able to neglect when we used fluorescent lamps. Color shift with temperature and current, accurate current control and heat management are just a few of the parameters we had to get involved with. Accurate light measurement was crucial for the development of these LED products. In the end, all these experiences started us thinking about LED measurement equipment and encouraged us to start manufacturing and selling LED light measurement instruments.

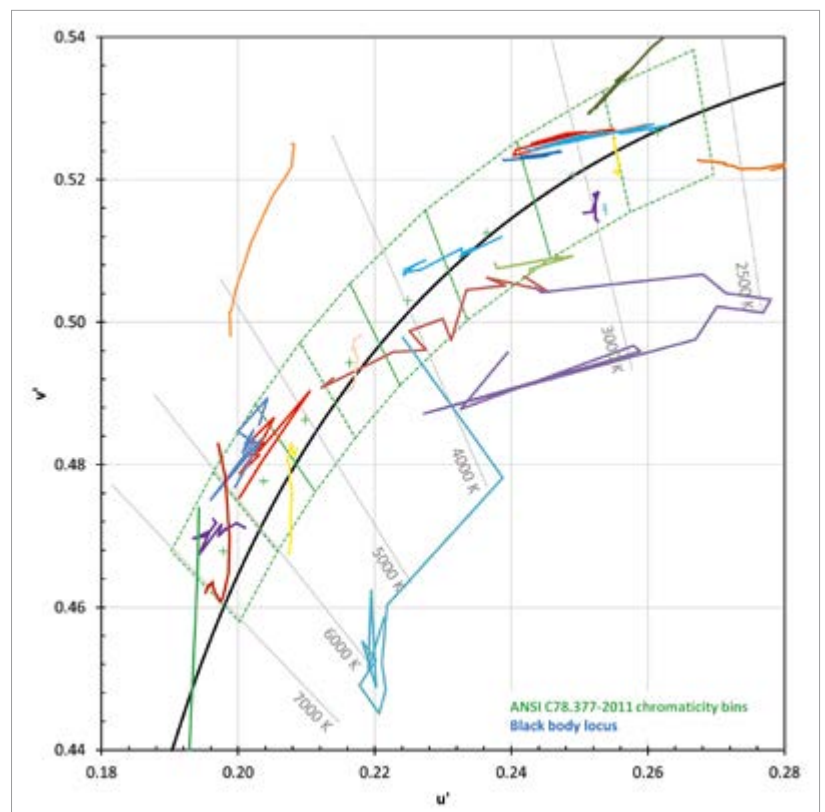

LED professional: Do you think that your history is an advantage for you regarding the LED measurement branch?

Mr. Gall: Since we don't come out of a laboratory, but rather from production and application, we took a different approach to it than most competitors do. Hardware and software are therefore designed differently, following our philosophy of producing and offering very versatile user-friendly devices. Solutions with plug-n-play capability.

Mr. Przybyla: Maybe another advantage that we had when we started the development of our measurement instruments was that LEDs were already on the market and in use as light sources. Therefore, we designed our devices from the beginning for LED measurement and did not need to make changes.

LED professional: What new trends and developments do you see coming? How will they affect your business and your products?



Signcomplex | We bring innovation and give impression



3P LED Lamp

Dust-proof tube, Impact-proof, Corrosion-proof

Available in 0.6m / 1.0m / 1.2m / 1.5m

Available in 30W / 55W / 70W / 80W

Available in 3-8 meters high



www.signcomplex.com
marketing@signcomplex.com
phone: +86 755 2760 8650
fax: +86 755 2760 8651

Figure 2:
In CIE127:2007 recommended sphere design for LED total luminous flux measurement. (a) for all types of LEDs, (b) for LEDs with no backward emission

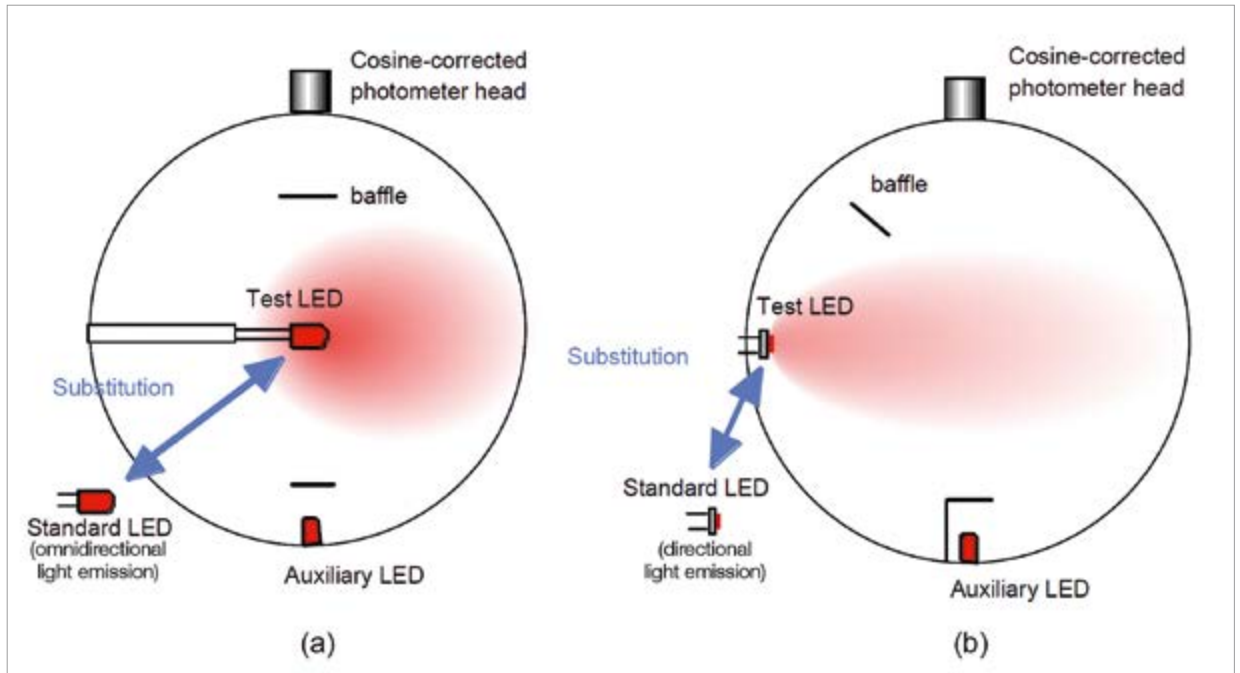

Mr. Przybyla: We recognize that the introduction and progress in LED technology encourages many people with good ideas to develop LED lighting products. Some of these people are not lighting specialists, and most of them are not metrologists, but they all need to test, measure and verify their developments. They are mostly also not scientists, but rather, engineers. For them an easy to handle, reliable system is very important.

To provide this easy handling, our spectrometers and accessories are equipped with a unique optical coding system that automatically assigns the correct stored calibration data to up to seven devices and its related measurement task. This guarantees correct measurement without the necessity of taking care of the alignment of calibration and accessory. That makes measurement tasks easier for non-metrologists as well.

LED professional: With all your experience I am sure you can certainly give our readers general advice on how to select a measurement system for LEDs. What are the most relevant differences they should take into account?

Mr. Gall: Today, it is absolutely crucial to make sure that all the equipment is designed to measure LEDs. The

measurement task has to be precisely defined to choose the right instrumentation. For instance, if you want to measure the luminous flux of an omnidirectional light source properly, usually an integrating sphere is used. You need an integrating sphere that is suitable for measuring LEDs. Because of physically different properties not all spheres are equally well suitable for that task.

LED professional: Can you explain these differences in more detail?

Mr. Przybyla: The first and most relevant difference between integrating sphere based measurement systems for so called traditional light sources and solid state lights is that they are equipped with photo detectors while for LED measurement the CIE standard CIE 127-2007 requires a spectrometer. The reason is that until now it was sufficient just to measure brightness while with LEDs it is necessary to measure the spectral power distribution to properly derive the luminous flux and other relevant properties like color rendering index and color temperature.

In addition, the reflective coating is different to that of older spheres. While the older systems had just a reflectivity of approximately up to 80% due to stray light issues and the UV emission of some light sources, the use of

calibrated spectrometers allows the use of coatings with a reflectivity of up to 97%. Modifications have to be made in order to make the older spheres ready for LED measurement.

LED professional: Can you give us an idea of what these modifications would be?

Mr. Przybyla: Sometimes the update with a spectrometer that is properly calibrated to the properties of the integrating sphere is sufficient. This solution is often used when a customer already owns a very big sphere of 2 or 3 meters diameter where the expenses for replacement and logistics would be too big. Here the coating may need renovating or a new coating may be necessary. But in most cases it is better and sometimes even cheaper to replace the existing system with a new one that is designed for LED measurement.

Furthermore, some details of the integrating spheres, like the design of baffles and the types of coatings are different now.

LED professional: What else is relevant for proper and comparable measurement?

Mr. Przybyla: The first thing that needs to be mentioned is calibration. To calibrate the system a halogen

We bring quality to light.



Putting LEDs in the right light.

SSL solutions from the world leader in LED measurement



Instrument Systems set the benchmark in LED testing with high-performance spectroradiometers for photometric and colorimetric measurements. Now we present another breakthrough in Solid-State Lighting with our new goniophotometers and integrating spheres.

Find out more about our innovations for SSL:
www.instrumentsystems.com/ssl

 **Instrument
Systems**
light measurement



Michael Gall

Michael Gall has been CEO and sole shareholder of JUST Normlicht GmbH since 1999. In 2009 he started the development of user-friendly solutions for spectral light measurement and colorimetry together with the Polish physicist Jan Lalek under the GL OPTIC brand name.



Micolaj Przybyla

Micolaj Przybyla is a Brand Director with GL OPTIC | JUST Normlicht GmbH. He joined GL OPTIC project in 2010 and since that time he has been responsible for worldwide marketing and product development of light measurement system for LED lighting evaluation. Prior to GL OPTIC, over the 10 year period between 1999-2010 Mr. Przybyla has had executive leadership role in PLASTIVAN a Belgian plastic processing manufacturer.

light source is used. Due to the characteristics of this light source, we have to deal with stray light. Furthermore, the broad band spectrum of the halogen lamp is completely different to some LED light sources that may have some prominent, narrow banded spikes in a wavelength. An example would be blue in "cold white" LEDs or RGB light sources.

LED professional: You just mentioned a very interesting issue: The single narrow spikes of LEDs. This raises the question about measurement accuracy. Ideally, to provide the best accuracy you should set the measurement range, the gain, in a way that the signal is at around 80% of the range, but at least over 30-50%. This is not always possible with LEDs. How do you deal with that issue?

Mr. Przybyla: This is a very interesting question. You are right; with LEDs it is possible to have a very prominent peak and a relevant rest of the signal that is very low, maybe below 5% to 10%. In some cases even lower. To provide sufficient accuracy under these conditions, your whole system needs to have very good dynamic range. Electronics from the spectrometer array to the amplifier, with low noise is crucial for that. If you provide such high dynamic electronics with low noise signals even below 5% can be measured accurately. Our hand-held spectrometer, for instance, offers a noise-to-signal ration of the complete system of 1:1000, while the laboratory spectrometer offers 1:2000.

LED professional: Accurate measurement is a precondition for standardization and certification. Two topics that I would like to address now, if you don't mind.

Mr. Przybyla: Yes, of course. These are two very important issues for the LED lighting industry.

LED professional: I think we have to distinguish between product standards that may be of very local relevance and global standards for measurement like the CIE 127-2007 we talked about before. CIE is responsible for providing these types of standards and that often takes time. Are there changes or new recommendations on the horizon, and how will they affect industry and, in particular, your business?

Mr. Przybyla: CIE 127-2007 is a relatively new standard, and I expect it to be valid without relevant changes for a while. In contrast to that stable situation, standards that allow comparison of products and standards that

define governmental and legal requirements are changing continuously.

Before the introduction of LEDs, more or less the only issue was brightness depicted by the wattage of incandescent lamps. Everybody was aware of what it meant to use a 40, 60, 75, or 100 W lamp. These products offered the same amount of light and light quality, independent of the manufacturer. This was broadly similar with fluorescent and compact fluorescent lamps, but this is not true with LED replacement lamps anymore.

The European Commission, therefore, created and updated a European regulation standard within the "Directive 2009/125/EC" on eco design. The "Eco Design Requirement" for domestic lighting concerns direct and omnidirectional lamps as well as luminaires. The new regulation became effective on September 1st 2013. In addition, the regulation for directional lights will be updated on September 1st 2014 and 2015.

This regulation defines minimum requirements and how to display product information in a comparable way on the package. The required data comprise efficiency, color temperature and color rendering index while not everything has to be displayed. The "Eco Design Requirement" is somehow comparable with Energy Star, which is very popular in the U.S.

LED professional: All these standards are based on measurements according to CIE 127-2007. How can it be made sure that the results that are measured with different systems are correct, and how big are the tolerances?

Mr. Przybyla: This is a very important question. Key for that is a proper calibration with reference light sources. There are many spectrometer manufacturers and spectrometers on the market, but only a limited number is properly designed and calibrated for LEDs.

Manufacturers of high quality measurement equipment, like GL Optic, strive to provide calibration on a very high level by using very accurate reference sources that are calibrated to the black body radiator. Due to this practice, the differences between different national laboratories is steadily becoming smaller and smaller. While 6 to 10 years ago the measurement differences between, for example BTB in Berlin, NPL in Great Britain and NIST was 10% or more. This inaccuracy has now been reduced to 4-6%.

Figure 3: Following a recognized trend, GL Optic's Spectis 5.0 combines laboratory performance with portability and flexibility for different applications

Mr. Gall: Currently all relevant national laboratories are exchanging their reference light sources to further improve calibration and to lower these differences. This process will be finished by 2015 and this will guarantee that measurement results of products that are evaluated in different places all over the world can be made comparable.

LED professional: Can you tell me why you created the new Spectis 5.0 that you introduced at LpS 2013?

Mr. Przybyla: It became apparent, that there is some demand for spectrometers that can be used on site as well as in the lab without compromising the accuracy. This latest development combines highest accuracy with good portability. This is the solution when the laboratory grade accuracy is required, and the flexibility to be used in the field is also necessary.

Mr. Gall: One could summarize that the Spectis 5.0 is a laboratory instrument that can be also used in the field if required, whereas the



Spectis 1.0 is a field measurement device that can be also use in a lab.

With the already available accessory and the provided calibration options it is possible to use it for very different measurement tasks from luminous flux measurement with integrating spheres to luminance measurement and with the cosine corrected measurement head, for illumination.

LED professional: Thank you for the interview. I am already curious as to what you will be introducing at the LpS 2014.

Mr. Przybyla: Thank you.

Mr. Gall: Thank you. We'll keep you up to date! ■

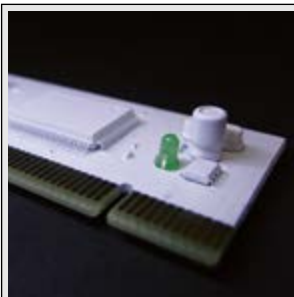

ELPELIGHT® products for LED technology

Light effects, such as diffusion or absorption for example under LEDs, can be avoided or indeed created with various lacquer systems for substrate coating. Casting resins or conformal coatings protect outdoor LED applications against environmental influences but also fulfil highest functional optical demands like very high transparency and UV light stability.

Please contact: peters@peters.de, www.peters.de

For the realisation and protection of LED applications



360 DEGREES FULL-BEAM ANGLE SPATIAL LIGHT LED

Characteristics:

Safety:

In $\geq 2.0\text{mm}$ sealing colloid densely with phosphor makes it effectively reduces the spilling of blue light.

Cozy:

Uniform and soft light makes no glare light.

Website: www.gszmlighting.com

Email: sale@gszmlighting.com



360 Degree led

CSZM®

LED Converter With High Dimming Performance

LEDs are light sources that are ideal for dimming applications. The available dimmable devices often differ in terms of their interfaces, efficiency and price. But what is often overlooked is that not only can LED control gear reduce the luminous flux and therefore the brightness, they also have a significant effect on the quality of light in the dimmed state. Giulio Borsoi, Research Engineer, Mathias Burger, Project Portfolio Management Systems, and Christian Nesensohn, Technical Project Manager at Tridonic explain why that is the case and propose a solution to minimize these effects.

Figure 1:
Relationship between dimming level and color stability for different dimming methods

Dimming is popular. Depending on the application, dimming can save energy and can also create a particular lighting mood. If, however, the dimmed light is felt to be unpleasant it can be assumed that the luminaires are rarely dimmed and the potential for energy savings is not exploited.

In most cases, LED control gear is designed to achieve maximum possible efficiency at a low price. An important factor, however, is the effect that the devices have on the quality of light in the dimmed state. This effect depends essentially on the dimming method used. Dimming can be achieved by pulse width modulation (PWM) or by analogue means using amplitude modulation (AM), or by a mixture of these two methods. Each has its own advantages and disadvantages, and the effects on the quality of light are also different.

Figure 2:
Efficiency of different dimming methods

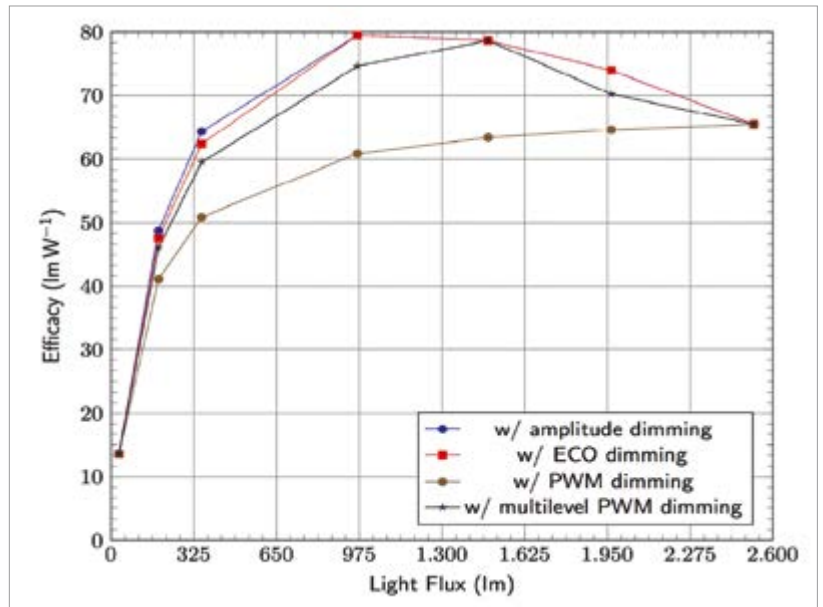
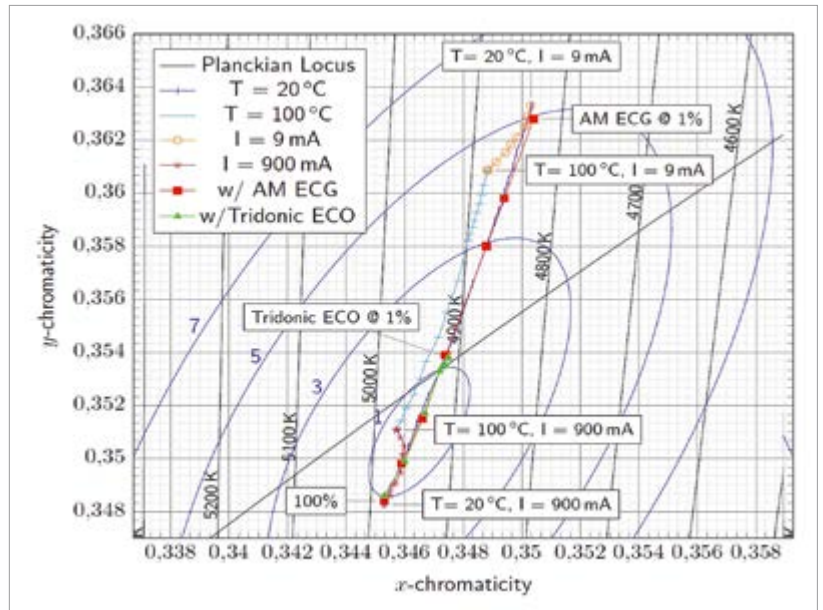

Driving LEDs

LEDs, because of their structure and principle of operation, require some care in order to be properly operated. Apart from the fact that the non-linear relationship between LED current and forward voltage requires the current to be controlled instead of the voltage, there are some subtle effects that have to be kept in mind when dealing with LEDs.

The efficacy of these devices has its peak at relatively low injection currents, usually less than 10% of the maximum ratings, and decreases at higher injection currents due to non-radiative recombination (e.g. Auger) or, in extreme cases, carrier overflow. On the other hand, at very low injection currents the efficacy drops to 0 due to the defects of the crystal in the active region. The decrease in the lumen output of LEDs is mainly related to the propagation of defects in the active region and the degradation of the package materials. Both of these mechanisms are temperature-activated and a reduction in device efficacy leads to higher operating temperature and therefore shorter lifetime.

Degradation not only leads to a decrease in efficacy or lumen output but also a shift in the chromaticity coordinates of the emitted light. It is therefore important to operate the devices as close as possible to their efficacy peak in order to preserve their functionality for as long as possible.

PWM operates between two states in which the device is either fully off or fully on; it is therefore always operating under the least effective conditions. Independent studies [1] have shown that PWM operation can lead to significantly greater degradation of LED performance compared to amplitude dimming. This is due to the fact that the relationship between the degradation rate and the stress level is non-linear, but the former is an exponential function of the latter. Therefore in the case of a PWM driver, halving the duty cycle is not equivalent to halving the current. It causes greater damage to the device and provides less light output. Pure amplitude dimming is therefore the best choice in the case of a healthy LED.

Although recent advances in the fabrication of semiconductor materials have reached very high levels and allow the production of devices with behaviors very close to the ideal, ageing is still a factor and IV characteristics degrade as well. The main effects of the degradation show up especially at very low injection currents where non-radiative recombination may become predominant, especially if the devices are subject to ESD or EOS events during installation or operation. In these conditions pure amplitude dimming could provide inconsistent results if very low dimming levels are used and the defect-related current components become relevant; PWM in these circumstances

Table 1:
Comparison between amplitude and PWM dimming

Amplitude Dimming		PWM Dimming	
+	High efficiency	+	Lowest colour shifts
+	Flicker free light	+	No brightness tolerances
-	Colour shifts at low levels	-	Low efficiency
-	Brightness tolerances at very low levels	-	Risk of flicker and stroboscopic effects

VS

A Universe of Light Measurement Solutions



LED Measurement Systems

StellarNet offers a complete line of portable, low cost LED test and measurement systems covering the 200-1700nm range. All instruments are NIST calibrated to measure the absolute intensity, with a selection of low cost integrating spheres ranging from 2" to 12" in diameter. These systems offer rugged, high performance measurements by utilizing shock-proof enclosures and permanently aligned optics to suit all your LED measurement needs, including QC and R&D applications.

- Irradiance (watts/m², μwatts/cm²)
- Luminous Flux & Luminance
- Illuminance (lux)
- Radiant Flux (watts)
- Color Temperature (CCT)
- Color Rendering Index (CRI)
- Dominant Wavelength & Purity
- Chromaticity coordinates x,y



can provide more consistent behavior from chip to chip and higher efficacy, although this last parameter might not be relevant at very low dimming levels.

PWM has the advantage that the LED is always supplied with its nominal current even in the dimmed state and there are therefore generally hardly any color shifts. At the same time, however, the constant switching of the LED can lead to flicker effects, precisely because a low and therefore better switching frequency is used.

AM scores favorably in terms of efficiency and the stability of the light – in other words no flickering – but does have the disadvantage that at low dimming levels (i.e. low currents compared to the nominal current) color drift in the LED module may be visible. In addition, the IV characteristic changes dramatically as the LED ages. At low dimming levels this may lead to large differences in brightness from LED to LED.

Both Pulse Width Modulation or Analogue Dimming

There is always an inherent drawback in opting for one or other of the two dimming methods. Although with PWM the color location remains constant, lower efficiency across the different dimming levels must be accepted as well as increased costs in terms of switching frequency for flicker-free or even camera-compatible operation. With AM the price for higher efficiency is poorer quality of light at low dimming levels.

It is obvious then that the two dimming methods can be combined to provide high quality of light at all dimming levels. At high dimming levels the AM method ensures flicker-free operation at maximum efficiency. PWM ensures color stability at amplitudes from 35 to 1 percent. A much smaller range is now dimmed using PWM so the duty cycle for the same dimming level and the same frequency is always greater than if PWM were used as the only method. The advantage is that fewer

disturbances due to flicker or stroboscopic artifacts can be expected.

Combining the two dimming methods does mean that there are a few challenges to overcome. The main challenge is to produce a clean dimming curve with no obvious switchover point between AM and PWM. A complicating factor is that the DALI interface standard uses only 8 bits to cover the entire dimming range. In the case of conventional light sources this comparatively low resolution was not an immediate problem thanks to the inertia of the light sources. LEDs react to changes in output without delay so these “steps” are now visible. A solution therefore has to be found within the converter.

Technical Implementation

The combined dimming approach can be implemented with the aid of a three-stage topology. Boost PFC (Power Factor Correction) is used as the input stage with the task of controlling the mains harmonics and the phase shift between current and voltage. It also provides a constant intermediate circuit voltage. For SELV separation a half-bridge and subsequent LLC circuit is used. This takes the intermediate circuit voltage and produces a high-frequency ac voltage which is then rectified and smoothed after the transformer for electrical separation between the input and output sides.

The LED current is then generated from the secondary intermediate circuit voltage via a current source - implemented as a buck circuit. An ASIC (Application-Specific Integrated Circuit) controls the PFC and the half-bridge on the primary side, with the ASIC itself being controlled in master/slave mode by a microcontroller. The microcontroller is also responsible for interpreting the commands via the interface. On the secondary side an ASSP (Application-Specific-Standard Product) controls the buck. At the same time the ASSP detects any connected resistance for adjusting the current or – if the resistance is temperature-dependent –

Figure 3:
Overview of mixed AM and PWM dimming

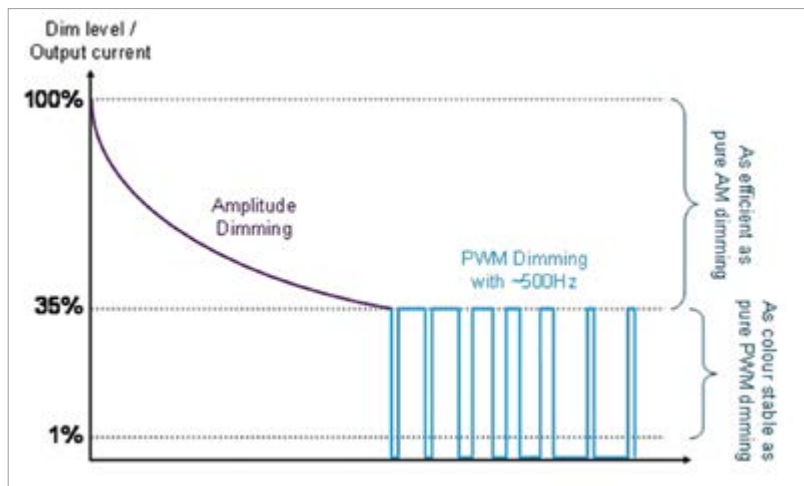
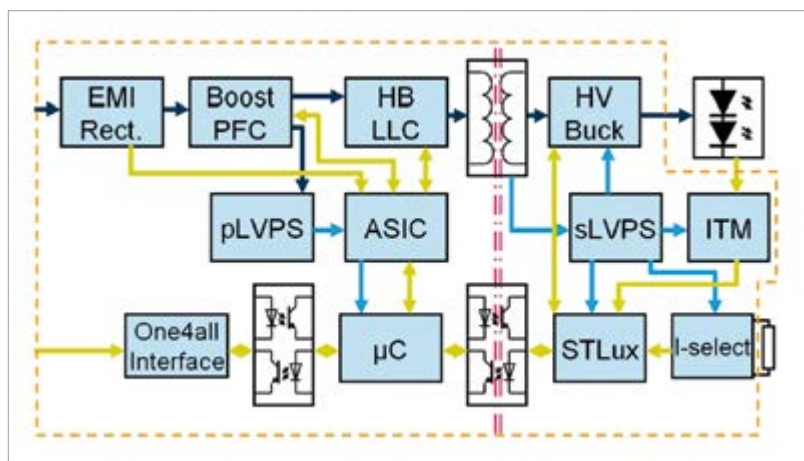

Figure 4:
Overview of control gear topology for the Tridonic ECO series



the temperature on the LED module. It is also connected via a UART with the primary side in order to receive commands from the primary microcontroller.

Coordinated Control Mechanisms for a Smooth Transition

The switch between amplitude dimming and pulse width modulation without any visible transition requires a few technical challenges to be overcome. One option is to have both control mechanisms active in parallel. This would ensure that each of the two control mechanisms is instantly ready to take over as soon as the transition point is reached.

Figure 5 shows the two, setpoint values for the control mechanisms as a function of the target dimming level. The two run in parallel and are limited in their inactive ranges but run virtually with the dimming level.

Figure 5:
Control mechanisms for AM and PWM

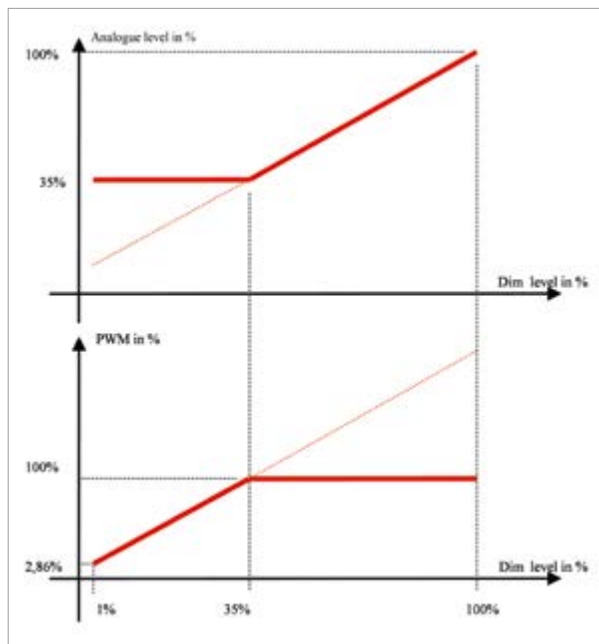

The control for amplitude dimming exhibits a PT-1 behavior, which causes the actual value to lag with respect to the setpoint. This means, for example, that when the light is faded up from 1% to 100% there would be a non-homogenous increase in the light as the dimming level passed through 35%. To reduce this effect so that it cannot be detected by the human eye the controller was designed as an adaptive device. In the initial period, therefore, the controller is considerably faster than later for static operation.

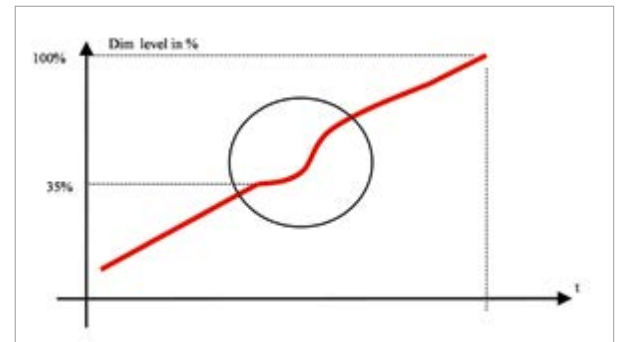

Figure 6: Lagging light behavior at the switching point

Figure 6 shows the dynamic behavior of the light for a fade curve from 1% to 100% and the lagging of the actual value at the transition to amplitude dimming due to the PT-1 behavior of the control circuit. This must be reduced to a minimum so that it cannot be detected by the human eye.

Stepless Dimming

Using DALI it is possible with Device Type 6 for LED control gear to adjust the light level in 255 steps (i.e. 8 bits). The human eye is capable of resolving much smaller steps however. In addition, the LED does not cross-fade when it switches between two setpoint values but more or less switches digitally, which makes the dimming curve more like a “dimming staircase” for the eye particularly at slow

SONTRONIC System-Vertriebs GmbH

LED Simulation
5-CH LED emulator



MCD-05-05002
5V / 200mA x 5ch

1-CH LED emulator



3340F 150W 2A 300V
3341F 300W 20A 100V

Sontronic
System-Vertriebs GmbH
Zur Deutschen Einheit 3/b
D-81929 München

Telefon +49 / 89 99301160
Telefax +49 / 89 937343
info@sontronic-gmbh.de
www.sontronic-gmbh.de

Besuchen Sie uns vom 12. - 15.11. auf der productronica in München.



productronica Halle A1 Stand 148

Figure 7:
Comparison
between BCM
and DCM

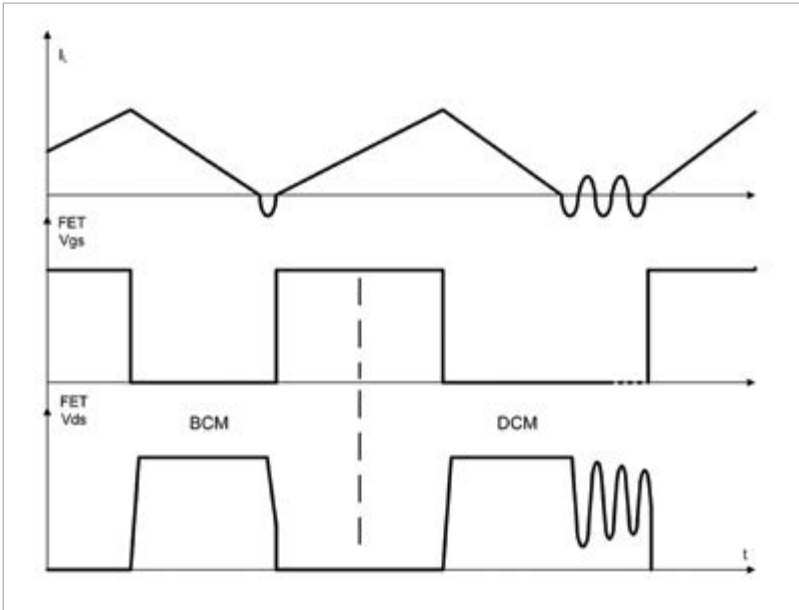

the PFC-FET a logic circuit has been installed. This allows switching only at a zero crossing of the voltage resulting from the resonance of the boost inductance and the FET drain source capacitance.

Figure 7 shows a comparison between BCM for the PFC and DCM. Whereas in BCM the FET is switched on again directly after reaching zero current (I_L), it remains off for a certain amount of time in DCM. However, it is still switched on in DCM when the current I_L is zero. This minimizes switching losses ($I_L \cdot V_{ds}$). Post-oscillation of the voltage V_{ds} can be detected; this is caused by the resonance from the boost choke and drain source capacitance.

Figure 8:
PFC FET on-time
as a function of
mains voltage

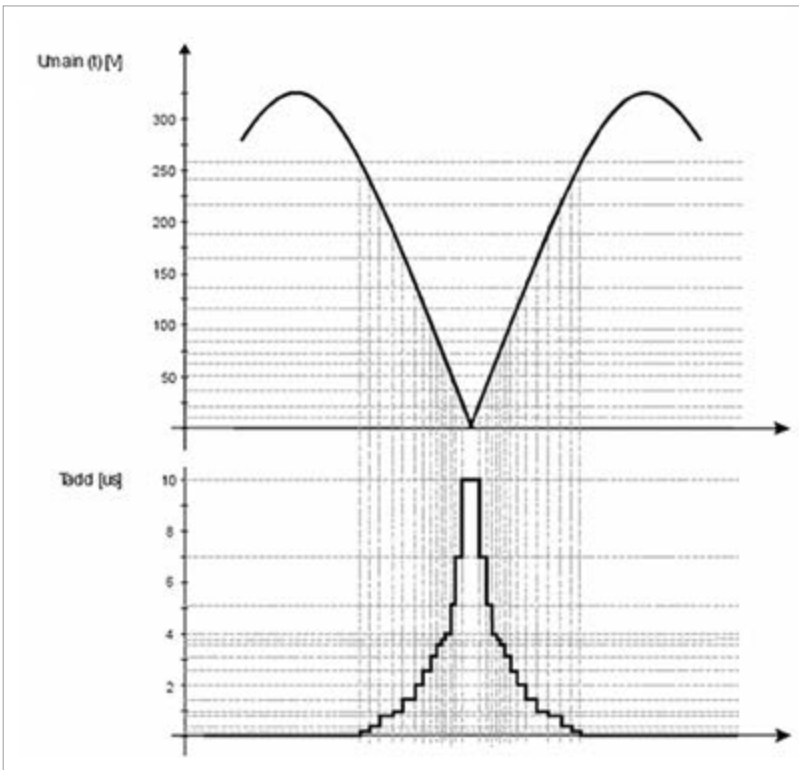

A logic circuit has also been included in the control chip for the PFC to minimize the harmonics in the mains current. This lengthens the switch-on time of the PFC switch as the mains voltage approaches zero. In this way, more current is drawn in this phase so the HF feedback capacitor is more heavily discharged. More current can then flow from the power supply and the plateau in the mains current is minimized so that the mains current is closer to a sinusoidal form.

Figure 8 shows how the on-time of the PFC-FET is artificially lengthened as a function of the mains voltage as the mains voltage approaches zero.

Two different sources for the LED current have been chosen. For the SELV range, in other words for output voltages less than 60 V a low-side-driven buck in CCM is used. This has the advantage that the LED ripple current can be directly influenced by the switching frequency. The disadvantage is that the buck switch is constantly under current, which leads to top losses and therefore to a rise in temperature at the switch.

Figure 9 shows the LED current of the buck stage in CCM mode. The ripple current is defined by the switch-on and switch-off times of the switch. Switching always takes place under current and voltage, i.e. not loss-free.

dimming rates. For this reason the 8 bits must be expanded internally to at least 14 bits. Only at a resolution of 14 bits or higher do the steps become imperceptible to the human eye so dimming appears uniform and is not seen as a succession of stages. Algorithms have therefore been integrated in the software for the device which expand the DALI-typical 8 bits into 16 bits and make them available to the controller as the setpoint value.

Large Load Range, Clean Power Supply

Since the large range of possible LED currents and LED voltage together with the dimming range of 1% to 100% represents a large load range the demands on the PFC block are high. Stable control of the intermediate circuit voltage has been achieved so that the PFC switches at low loads from Critical Conduction Mode (CCM) or Borderline Conduction Mode (BCM) to Discontinuous Conduction Mode (DCM). To minimize switching losses in



LONG GLASS TING

LED optics made from glass. The intelligent choice.

LED technology is more efficient today than ever before. So why use yesterday's materials? Rely on the advantages of our optics made from glass: temperature and UV resistance, stability and a long service life. In addition to proven standard products, we develop customer-specific and precise solutions: for your groundbreaking lighting concepts. And for light that stands the test of time.

See for yourself – at **Light+Building 2014, Hall 4.1, Stand J10!**

www.auer-lighting.com/led



Multifunctional AR111 Module using high efficacy COB component

★HM Emitter High CRI (up to 90) Version is Coming Soon!



EdiPower II HM Series

- Available in **5~40W**
- **CRI >80**
- **110 lm/W** for Warm White

Features:

1. Using Edison Opto's high lm/W COB LED.
2. Combines lens and reflector to achieve beam angle <math><15^\circ</math> .
3. Provides interchangeable reflectors to create different lighting effects.
4. Reflectors can be interchanged by users easily with a rotated action.
5. High uniformity collimated system-Patent pending.



Easy to assemble



4F, No.800, Chung-Cheng Rd., Chung-Ho Dist., New Taipei City, Taiwan 23586
T+ 886 2 82276996 F+ 886 2 82276997 service@edison-opto.com.tw

©2013 Edison Opto Corporation

Figure 9:
LED current at the buck stage in CCM mode

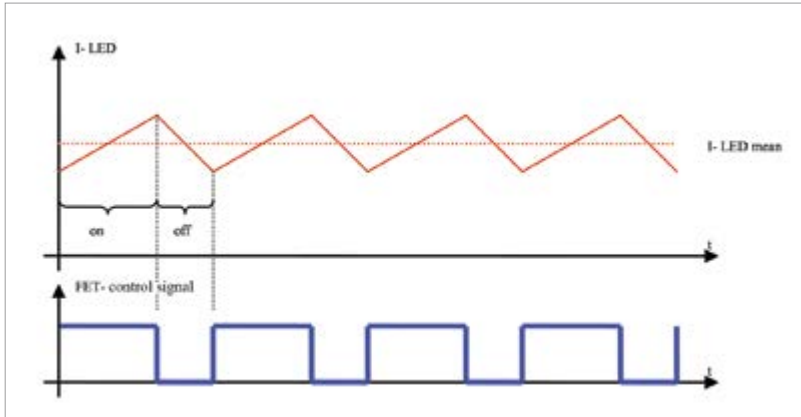
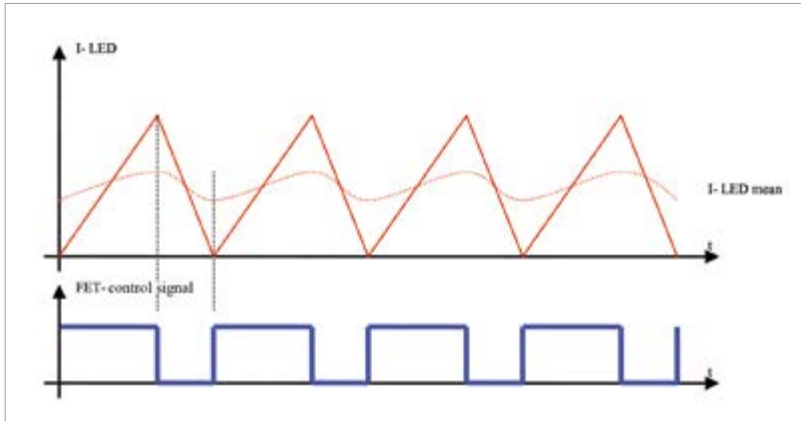

Figure 10:
LED current at the buck stage in DCM mode



For this reason a buck stage in CCM is used for the option with a relatively high output voltage. This has the advantage of voltage-free switching. Since the current here has a saw-tooth waveform which goes down to zero in every period there is a large LED current ripple which has to be attenuated by a loss-generating output filter.

Figure 10 shows the LED current of the buck stage in DCM mode. The current always goes to zero here, and the peak value therefore always to twice the rms value of the LED current. To attenuate this ripple an L-C filter is needed on the output side. Switching is always without current so that switching at relatively high voltages is possible.

Lower Standby Losses

To keep standby losses as low as possible at the same time an intelligent energy management system has been provided. The complete secondary side, for example, is switched off in standby mode to prevent unnecessary current demands. In addition, all the blocks in the ASIC that are not needed for standby mode are switched off. Only mains voltage monitoring runs at a low level in order to restart the device in the event of a switch to DC in emergency lighting mode.

Low-power mode is also activated in the microcontroller. The internal oscillator is deactivated and the microcontroller reacts only to a few interrupts which wake up the system. These interrupts include monitoring the

interface to receive any dimming commands and monitoring the ASIC which may notify the requirement for emergency lighting mode.

All the measure paths within the device that constantly draw current are of extremely high-impedance design. Optimum signaling technology and intelligent algorithms ensure that measurement signals are reliably differentiated from interference signals.

Better LED Dimming

The use of amplitude dimming to reduce the current of the LEDs as soon as possible in order to achieve higher efficiencies and then further dim down the devices with PWM in order to avoid the problems caused by the degradation of the electrical characteristics of the semiconductor enables the best compromise between efficiency, color stability, color consistency, reliability and lifetime to be achieved. This technology means that dimming not only saves energy but also maintains the original quality of light at all dimming levels. The basis for this was a detailed analysis of system behavior in conjunction with LEDs carried out before the development of the control gear. ■

References:

- [1] M. Meneghini, M. dal Lago, N. Trivellin, G. Meneghesso, E. Zanoni, Degradation mechanisms of high power LEDs, LpS 2013.

QFN LED FEATURES

EMC lead frame,
Small size, high power,
Max Ta:105°C, Typical R_{th}:10°C/W.



QFN-2835



QFN-3020



QFN-4014



QFN-3030

QFN-2835 series 1W
QFN-4014 series 0.8W

QFN-3020 series 0.5W
QFN-3030 series 1W、2W



深圳市瑞豐光電子股份有限公司
SHENZHEN REFOND OPTOELECTRONICS CO.,LTD.

Stock code:300241

E-mail:sales@refond.com

Tel:(+86)755-29675000

Fax:(+86)755-29675111

www.refond.com

Microbiog



Intelligent Over Temperature Protection for LED Lighting Applications

LED lighting is becoming increasingly popular. It offers numerous advantages over conventional lighting, but there are still some issues. One is thermal management. Bernd Pflaum and Hakan Yilmazer from Infineon Technologies explain how LED driver ICs with smart over temperature protection help to increase lifetime and optimize system costs of LED lighting systems.

System manufacturers are addressing thermal challenges by designing systems with appropriate heat sinks, high thermal conductivity enclosures and other advanced thermal design techniques. Generally these manufacturers do not consider the LED driver IC as a control component in the thermal system. The use of an LED driver IC with intelligent over temperature protection provides an additional control mechanism that can increase the lifetime of LED light sources significantly, ensuring the rated lifetime and reducing the incidence of defective products. Depending on the lighting manufacturer and application,

useful lifetime for LED lighting products range from approximately 20,000 hours to more than 50,000 hours compared to less than 2,000 hours for incandescent bulbs. The intelligent thermal protection also helps to reduce system cost by enabling system integrators to design the heat sink with a lower safety margin.

Despite the very high efficiency of LEDs compared to other light sources a large portion of the energy used to drive LEDs is converted to heat. Unlike other light sources, like incandescent bulbs, LEDs generate little or no infrared radiation. That's why the generated heat must

be conducted from the LED die to the underlying circuit board and heat sinks, housings or luminaries frame elements. If this heat transfer system has design or manufacturing flaws, or the system experiences extremely high temperature conditions the LEDs, the driver IC or other heat sensitive components like electrolytic capacitors can be damaged.

The patent pending smart thermal management technology included in the latest LED driver ICs can help to protect the system from thermal failure resulting in improved LED system designs.

Figure 1:
Lifetime of LEDs is a function of the junction temperature
(Source: EOS)

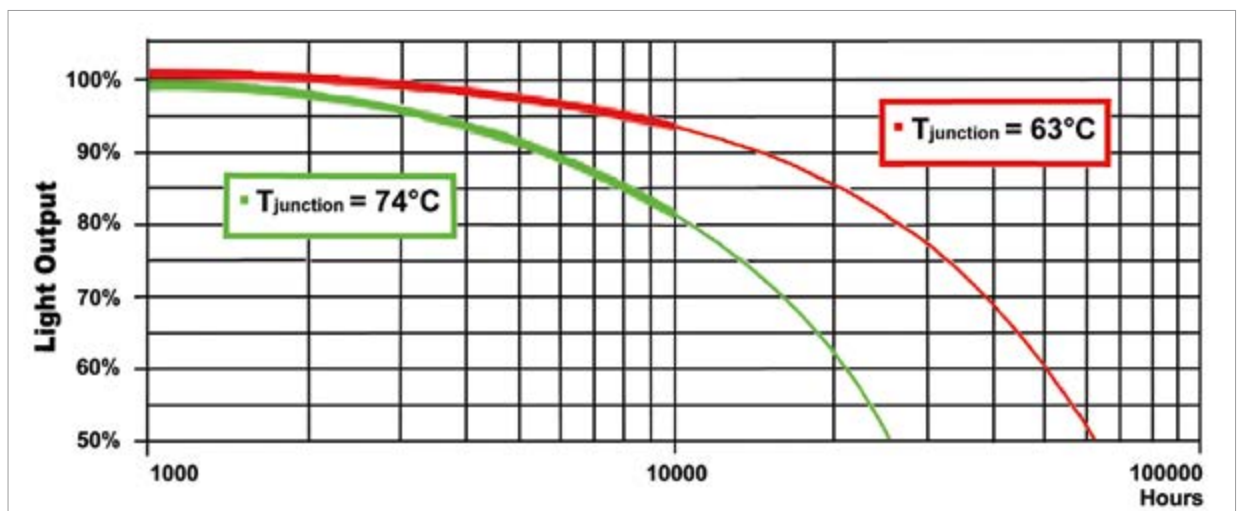

LED Lifetime Depends on Temperature

In general, high quality LEDs are robust devices that can operate in excess of 100,000 hours, when properly operated. The lifetime of LEDs is directly related to the junction temperature to which they are exposed. Increasing temperatures can reduce the operating lifetime significantly. Figure 1 illustrates the light output over time (experimental data to 10,000 hours and extrapolation beyond) for two identical LEDs driven at the same current but with an 11K difference in T_j . Estimated useful life (defined as 70% lumen maintenance) decreased from about 37,000 hours to 16,000 hours, a 57% reduction by a temperature increase of only 11K.

Different Approaches for Thermal Protection

The thermal design is often focused on the heat sink and PCB design, while the opportunities for thermal management by the LED driver IC and driving circuit are not considered. Intelligent over temperature protection by the LED driver IC can increase the lifetime of LED light sources significantly.

Temperature protection with LED driver ICs can be implemented in a variety of ways. Some LED driver devices include a sense pin to which an external temperature sensor may be attached. Different temperature sensing devices, including diodes, on-chip sensors, positive temperature coefficient (PTC) or negative temperature coefficient (NTC) thermistors can be used in LED lighting applications to protect the LEDs from overheating. NTC thermistors are often the preferred choice for temperature sensing and control in many of these applications, primarily because of their small package sizes and attractive price/performance ratio. But accuracy, response time and thermal gradient depend on the way the NTC thermistor is mounted. Once the temperature is accurately sensed, the response to over temperature must be considered. The typical response is to trigger an abrupt turn off of the current to the LEDs when a critical temperature has

been detected. These devices can then “restart” when the temperature is reduced or wait until a power cycle to restart. There are some disadvantages related to these methods:

- The abrupt shut-down method leads to setting the shut-down at a very high temperature in order to avoid incorrectly triggered shutdown. While this high value usually protects from catastrophic failures it still can result in significant reduction in the lifetime of the LEDs.
- Turning off the LED current means that the light is switched off abruptly. This can cause a serious situation like panic in public areas.
- Most drivers automatically restart when the system has cooled. Once restarted the system will heat up and shut-down can occur again resulting in a disturbing flicker effect.
- Drivers that latch “off” after the failure which requires a power on reset which is often not easy to implement or even not possible.

In security relevant applications (e.g. the illumination of emergency exits, escape routes, emergency shut-down switches, etc.) a simple shut-down of the LED driver is insufficient as maintaining the illumination is essential. This shut down behavior may also be insufficient in non-security related applications where light output is necessary under extreme conditions such as hot environments. Finally, it is desirable to reduce the required external components necessary to operate the LED driver and to protect the driver as well as the LEDs. The components required to provide the

thermal protection should be inexpensive and easy to integrate into an illumination device.

IC Implementation of Smart Over Temperature Protection

Leveraging the key idea of a patent to use the LED driver IC as a thermal sensor a patent pending technology has been developed to protect the LEDs with a slope dimming characteristic and adjustable trigger temperature for the start of thermal protection to overcome the limitations of conventional LED system designs. The new technology was implemented in the recently announced DC/DC hysteretic buck LED driver with high side current sensing (Figure 2).

Key Benefits of IC Implemented Over Temperature Protection

Saving system cost by using the driver IC as a thermal sensor for thermal protection

The driver IC can be used as a reference temperature to determine the LED temperature in systems where the driver is thermally coupled to the LEDs. This saves cost of NTC, additional wiring and connector pins. In addition, the design for thermal protection is simplified.

In a case where the driver IC cannot be installed with a tight thermal coupling the ILD6 series devices can also use an external NTC sense

Figure 2: Application circuit with the new ILD6070 driver: The current reduction is triggered at a threshold of the solder point temperature of the LED driver IC which is adjustable using an external resistor connected to the Tadj pin

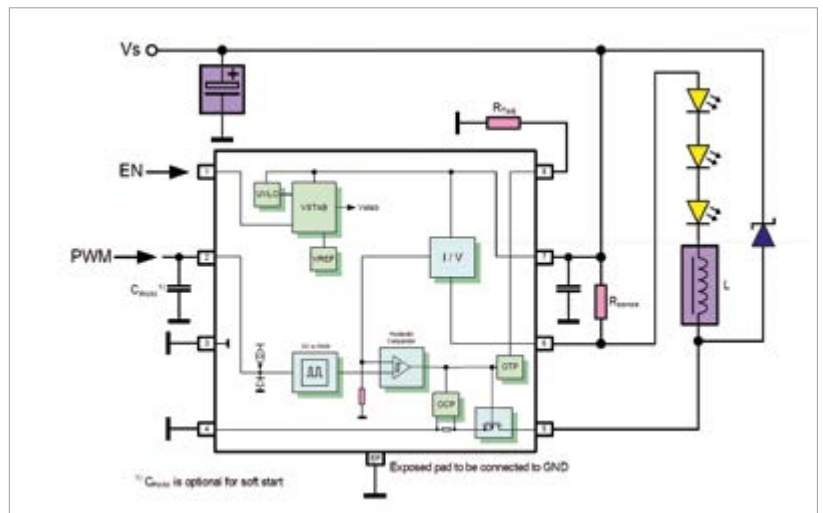

Figure 3: Depending on the application, the new driver ICs can use both internal temperature protection and external NTCs for thermal protection

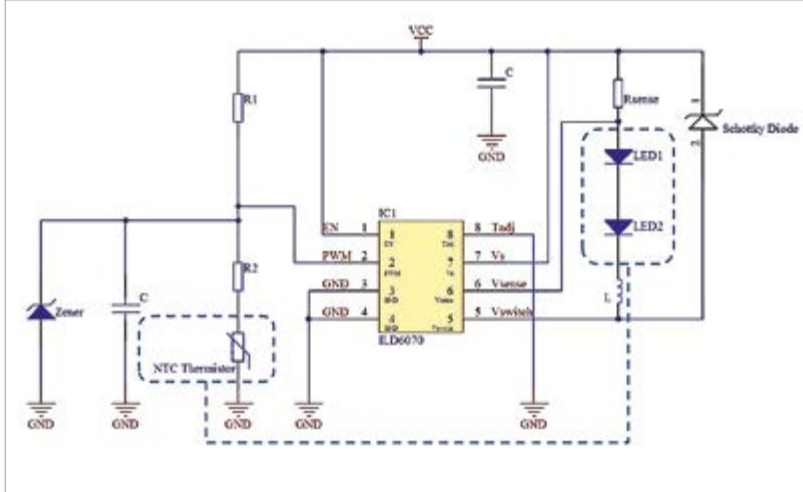
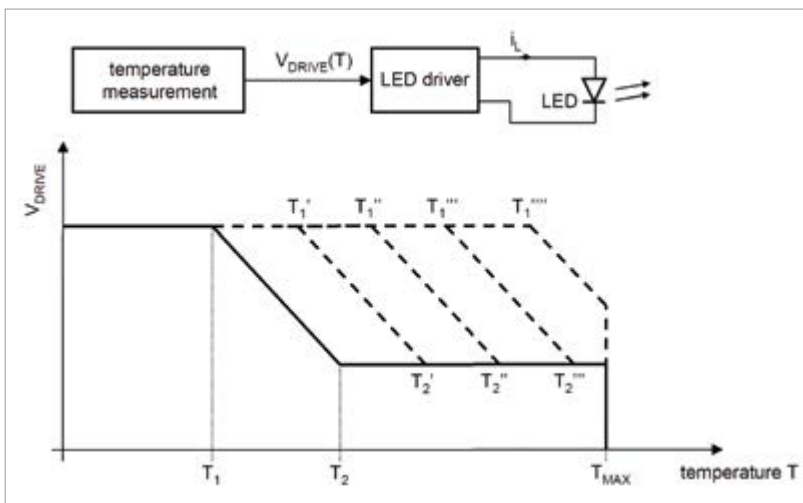

Figure 4: Basic concept of the adjustable temperature protection



The general concept behind this approach is described in figure 4. An LED driver is coupled to an LED (or a series circuit of LEDs) and configured to provide a load current I_L to the LEDs. The LED driver generates the load current I_L in accordance with an internal drive signal V_{DRIVE} such that the average load current matches the drive signal. Thus, the drive signal indirectly determines the average load current and, in turn, the luminous intensity of the LED. A temperature measurement circuit generates the drive signal V_{DRIVE} so that it depends on temperature. The LED driver should be placed close to the LEDs to sense the temperature precisely.

When a specific first temperature (T_1 in figure 4) is reached, the drive voltage V_{DRIVE} is reduced. The decrease of the drive voltage V_{DRIVE} continues as the temperature continues rising. When a specific second temperature (T_2) is exceeded, the drive voltage remains approximately constant. However, if the temperature rises and exceeds a maximum temperature T_{MAX} then a thermal shutdown is initiated.

element to protect the system (Figure 3). The NTC thermistor is placed near the LEDs to sense the temperature of the LEDs accurately.

Protection of LED lifetime by slope dimming mechanism

Reducing the LED average current with an integrated slope dimming mechanism protects the lifetime of the LEDs by reducing their junction temperature.

The protection circuit should ideally result in LED power deliver that has a smooth protection characteristic as hard switching may lead to flickering.

If a light source driven by the new LED drivers is exposed to a higher temperature condition than foreseen in the thermal design, the driver ICs will reduce the average current of the LED continuously in a slope-dimming characteristic; not abruptly.

This continuous range of adjustment allows the system to come to an equilibrium point that provides continued operation of the light source under exposure to the extraordinary condition with reduced light output. If the thermal equilibrium is overrun by additional thermal load this gradual reduction continues until a minimum of 25% of the target LED average current is reached and the light source will continue to provide light output with a luminance level of minimum 25% of the target light output.

The smart slope dimming mechanism enables customers to design their lighting solutions according to the main operating temperature range. Unforeseen peak temperature conditions which could destroy LED system can be protected by the smart slope dimming feature. This offers the option to design lower safety margin for heat sink size and herein save system costs.

The patent pending circuit design is based on standard components like resistors, diodes, capacitors, transistors, comparators or operational amplifiers (Figure 5). The temperature measurement is handled using serial Si diodes placed near the power stages, as the hottest and most sensitive parts in the driver IC. If LEDs are heating up, the power stages would recognize the temperature difference. The diodes are also placed close to power stages to protect the IC itself from overheating.

It is important to note that the V_{drive} signal is compared with an internal Sawtooth signal to generate an internal PWM signal for the dimming. The current I_{temp} is composed on the temperature dependent I_{slope} current and a fixed temperature independent current created by transistor T2, Si diode D2 and resistor R1. The external resistor (R_{ext}), controls a current source part which is added to the temperature dependent

Figure 5:
Simplified block diagram of the smart over temperature protection circuit

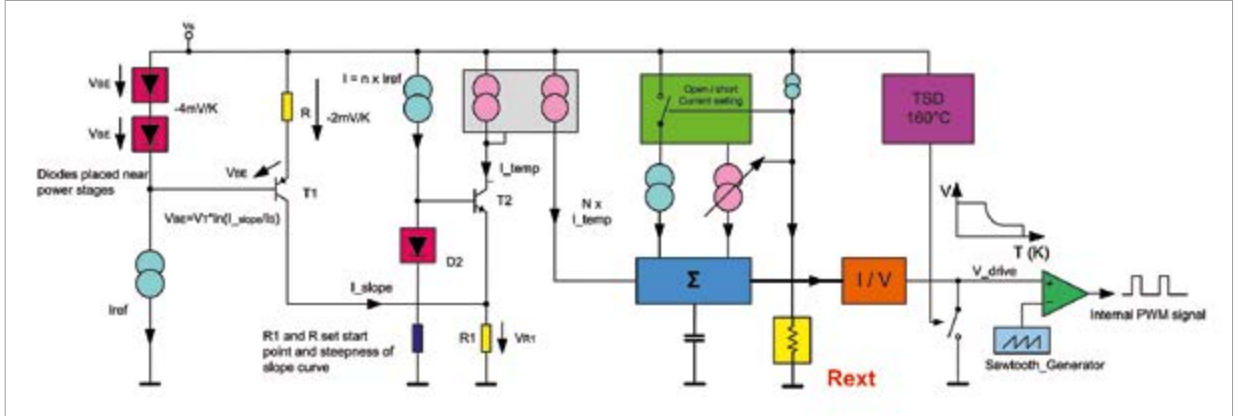

current $N \times I_{temp}$. Based on this analog circuit the trigger point where the slope starts can be selected. At $R_{ext} = \text{short / open}$ dedicated currents are implemented, which set certain slope characteristics. Both states are detected by comparator circuits.

The slope curve is decreasing with a certain incline to a minimum value defined by the protection circuit. Is the minimum value reached as the driver is overheating; the protection circuit keeps the LED lighting on a defined level. If the temperature further increases to more than 160°C the V_{drive} signal and therefore the LED current is completely switched off.

Optimization between lifetime and cost for thermal system by adjusting the triggering point for thermal protection

Luminary manufacturers can adjust the temperature that the protection engages by selecting the value of a low cost external resistor according to the end customer and application needs.

The current reduction is triggered at a threshold temperature of the junction temperature of the LED driver IC which is adjustable by an external resistor. The trigger point and the related profile can be set by using a resistor connected between the T_{adj} pin and GND pin (Figure 2). Based on the adjustable approach, the starting point of the current reduction at high temperature can be designed according to the specific LED lamp requirements. Therefore, the light system designers can optimize their products between cost and lifetime. In case a long lifetime has to be guaranteed to end customers the system integrators may decide to adjust a trigger point at a lower temperature. If system cost is the main competitive criterion, the triggering point can be set at a higher temperature in order to ensure nominal light output at higher temperatures and to protect the system by the thermal protection function of the IC instead of increasing the heat sink size to cover operating condition extremes. The lifetime of this LED system design will be shorter than the design mentioned first due to the higher junction temperature of the LEDs.

It should be noted that the heat sink must be designed in a way to maintain the operating temperature range of LEDs during normal operation.

Figure 6 shows measurement results of the profile with output LED current's duty cycle versus junction temperature of the ILD6070 driver by using 0 Ω, 10 kΩ, 20 kΩ, 35 kΩ and open at T_{adj} pin.

Maintaining light color during thermal protection due to PWM dimming method

Dimming by generating an internal PWM signal during thermal protection ensures that the light color doesn't change. Since the light color remains practically unchanged it might not be visible to end users that the LED system is in thermal protection mode.

The integrated temperature protection circuit will start to reduce the LED current by internal PWM modulation once the certain temperature trigger point of the slope characteristic of the IC is exceeded.

Figure 6 (left):
The adjustable trigger point defines the starting point and the shape of the slope

Figure 7 (right):
PWM modulated light output keeps the color unchanged during thermal protection

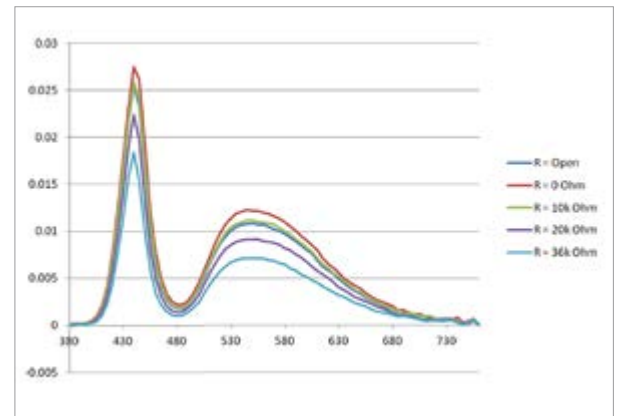
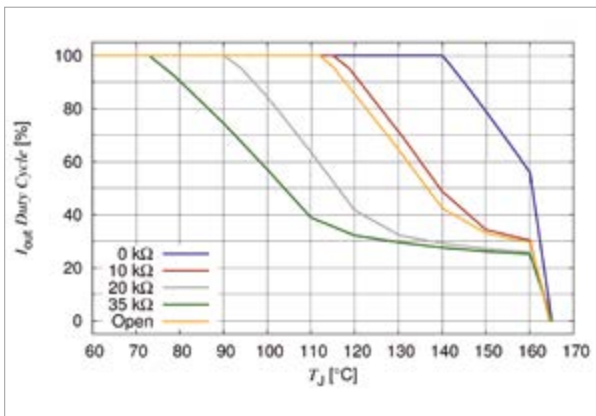

The LED current will be modulated by changing the duty cycle of an internal generated 1.6 kHz PWM signal due to thermal protection mode. As a result, the output light generated by the LED will be modulated by the PWM pulses, as well. The key advantage of having PWM modulated light output is that the wavelength spectrum and therefore the color of the light remains unchanged.

As shown in figure 7, the wavelength spectrum is only reduced in magnitude at different settings on the adjustable external resistance. For this experimental set up the module was heated up by LEDs and the hot ambient air to 120°C, where the IC works at thermal protection mode.

Summary

A key challenge in implementing high quality and durable LED lighting systems is managing the heat emitted from the LED components and electronics. Luminary designers are advised to consider other ways rather than only the heat sink design in order to manage the high thermal load at the PCB. This results in various benefits for luminary manufacturers and end users:

- Improved total cost of ownership by increasing the lifetime of the LED system
- No outage of light in thermal protection mode, in most cases there will be sufficient light available
- Reduced system costs for thermal protection since

- no NTC is required if the driver IC can be thermally coupled to the LEDs
- the heat sink design can be optimized
- Flexibility
 - to use the LED driver IC with or without an NTC depending on the distance between the driver IC and the LEDs
 - to adjust the trigger temperature for the start of thermal protection depending on end customer and application needs

With this smart thermal management technology described here and used in the latest LED driver generation, the lifetime and cost of LED designs can be significantly improved. ■

References:

- [1] "Thermal Management of White LEDs", DOE, February 2007
- [2] "Solving the System-Level Thermal Management Challenges of LEDs", Mentor Graphics Whitepaper, 2011
- [3] Application Note „ILD6070 60V/0.7A Highly Efficient Step Down LED Driver With Adjustable Thermal Protection“, Infineon Technologies, July 2013
- [4] Application Note 'ILD6150/ ILD6070 Thermal Management for LED Light Engine, Infineon Technologies, August 2013
- [5] Detailed information about the LED drivers with smart thermal protection can be found under the link www.infineon.com/lowcostledriver

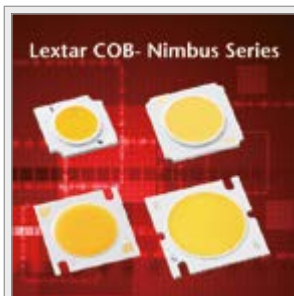

Simplify Your Design from Lextar High Quality COB

applicable to bulbs, par light, down light, track light, street lamps and high bays. COB is widely adopted recently thanks to its quality light, no multi shadow, low thermal resistance and good uniformity. It brings benefits to manufacturers for its simplifying luminaire design and reducing assembly costs.

For more details see Lextar.com

Lextar
Lextar Electronics

Sales.LM@Lextar.com



HIGH HEAT RESISTANCE AND ANTI-UV EMC-SERIES

High heat resistance and Anti-UV EMC-3030 (QFN Package LED), Much Economical than PCT or Ceramic LED; Compact size with high power & high luminous efficiency (Max: power 1.5W and 120lm/W); Applications: Spot light, bulb, TV backlight etc. (Rth: 14°C/W, Power: 1W, Typical: 110lm@150mA)

en.honglitronic.com

 **HONGLITRONIC**
鸿利光电
Stock code: 300219

sales@honglitronic.com



World's leading event for LED/OLED Lighting

—From manufacturing technologies to stylish design lightings—

LIGHTING JAPAN 2014

Consists of 3 specialised shows;

6th **LED/OLED Lighting Technology Expo**

4th **LED/OLED Light Expo**

DESIGN LIGHTING TOKYO 2014
2ND TOKYO DESIGN LIGHTING EXPO & CONFERENCE

Exhibit here and meet key persons from around the world

For more info ▶▶▶
www.lightingjapan.jp/en/

January 15 [Wed] – 17 [Fri], 2014

Tokyo Big Sight, Japan

Organised by: Reed Exhibitions Japan Ltd.

Organised by

 **Reed Exhibitions**

LIGHTING JAPAN Show Management, Reed Exhibitions Japan Ltd.
18F Shinjuku-Nomura Bldg., 1-26-2 Nishishinjuku, Shinjuku-ku, Tokyo 163-0570, JAPAN
TEL: +81-3-3349-8518 FAX: +81-3-3349-8530 E-mail: light@reedexpo.co.jp
A division of Reed Business Registered in England, Number 678540

HD-Retina LED Technology - Light Quality Beyond CRI

A common assumption is that full sunlight or traditional incandescent light offers ideal visual comfort. This is not the case, however, because both also tend to distort color. As an alternative, natural light that corresponds to between 3,500 K and 3,700 K has been identified to be ideal for human perception. The “HD-Retina” concept takes this finding into account. Giulio Vezzani from Martini Light discloses their latest insights into color perception, how the new approach works and how it differs from other HQ high CRI systems.

The design of the light spectrum emitted from a light source has always interested humans, since light represents a basic requirement for our lives. For many years traditional light sources, especially incandescent lamps, have satisfied this requirement. Within the last few years, LED light sources are increasingly replacing these traditional light sources. We can imagine that LEDs represent the transition from the analogic generation to the digital generation for light sources.

However, all LED light sources have been developed following the same target of copying the experience of traditional light sources. As result and in the best cases, they emit a similar light to traditional light sources.

Some years ago, Martini S.p.a decided to explore alternative ways and to investigate how to generate a new and improved type of light source resulting in the HD Retina LED concept, bringing LEDs into the digital age of light.

Table 1:
Summarized results given by the metrics for traditional light sources

Measurement Methods

Together with the luminous efficacy (lumens per watt), the degree of light quality emitted from a light source is always one of the most important parameters in the evaluation of the quality. Several metrics were developed as far back as 1960, to measure the quality of emitted light. Among the many proposals, the Color Rendering Index (CRI) [1], recommended by the Commission Internationale de l'Éclairage (CIE), was affirmed. CRI was defined at the beginning of the 70's and revised in 1995. Although there are known limitations [2, 3] and in recent years other metrics have been defined to measure the quality of light, the CRI is still the standard reference for all producers of light sources.

Recent developments in LED light sources continue to pursue CRI as the way to measure the quality of light. LED light sources are available today

with $CRI \geq 95$ and theoretically, if we continue in this direction and maximize up to $CRI = 100$ and choose the color temperature (CCT) = 2812 K, an LED could be produced with a quality of light equal to the incandescent light bulb.

For the development of the HD Retina light source it was decided early, not to consider CRI as the only indicator of the light quality, but also to focus on alternative metrics. The most important among these were the Color Quality Scale (CQS) [4] and the Memory Color Rendition Index (MCRI) [5].

The Color Quality Scale was developed by Y. Ohno and W. Davis and is recommended by NIST. It is currently one of the leading candidates for replacing the CRI. Like CRI, CQS uses a blackbody (Planck locus) obtained from Planck's law as reference, but it differs by using most saturated patch color and other

Lamps	CCT (K)	Duv	CRI	CQS (Qa)	MCRI (300 lx)
Super HPS	2529	-0,0023	85	84	81
NeoDimium	2757	-0,0048	77	90	87
Incandescent	2812	-0,0001	100	100	83
Halogen	2912	0,0005	100	100	83
Cool White FL	4290	0,0015	63	63	65
D65	6504	0,0034	100	100	90

Figure 1:
Performance of several color rendition and color quality metrics

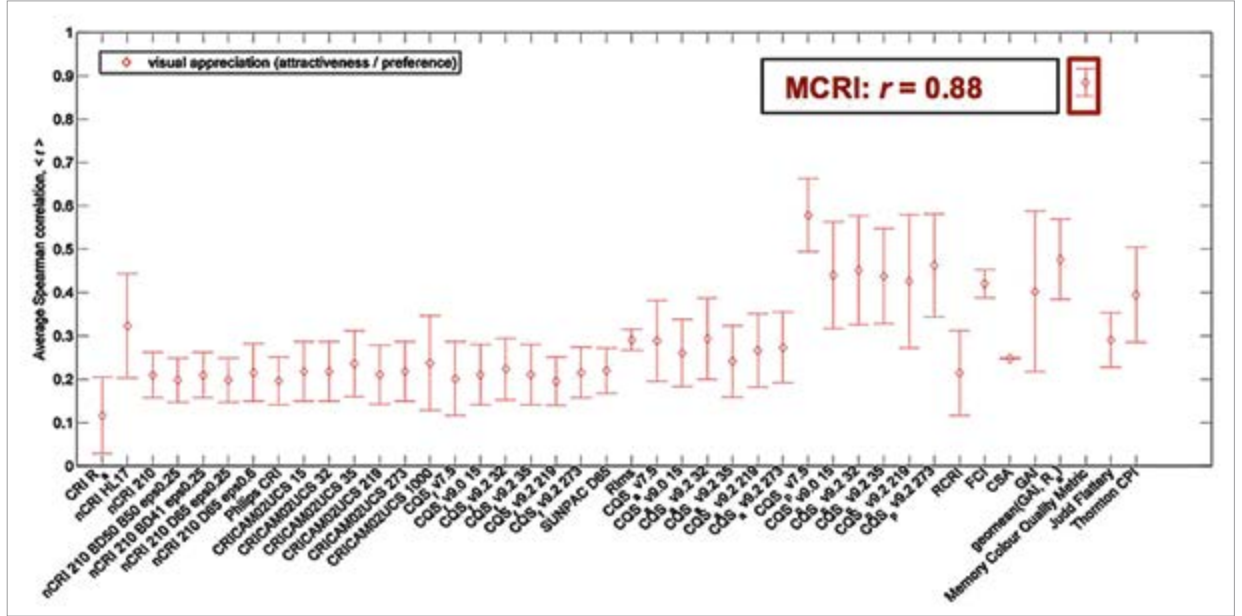

calculation methods to evaluate the score. The dependence of CRI and CQS on the blackbody means that an objective metrics has been defined which is particularly useful for the evaluation of color fidelity.

Memory Color Rendition Index was developed by K. Smet and P.Hanselaer from Gent University (Belgium). MCRI uses a statistical model [7] based on color appearance to build a reference. That means that the metrics is particularly useful for the evaluation of color preference and attractiveness.

The MCRI has been validated in two recent scientific publications [8, 9] using observer ratings from several published visual experiments [9-12, 14-18]. The memory color rendition index, R_m , was found to correlate highly ($r = 0.88$, $p < 0.0001$) with the visual appreciation of white light sources. In addition, the MCRI was found to be significantly better at it than several other published color

rendition and color quality metrics. The results are illustrated in Figure 1.

The right mix of these metrics allows defining spectrum data with good characteristics that can permit prototyping a light source offering both high fidelity and high preference values.

Duv value presented in table 1 is the distance from the Planck locus on the CIE 1960 uv chromaticity diagram, with polarity, plus (above the Planck locus) or minus (below the Planck locus).

Simulations Methods

The design of a light source that is only based on measurement methods usually requires an intense development of physical samples to calibrate all of the remaining parameters such as chromatic coordinates of white point and lots of visual tests to evaluate a correct color reproduction of the light source.

Given the inability to go directly to visual tests, (Martini Spa is not a manufacturer of light sources), a software (both for PC and iPad) has been developed that allows visual tests to be simulated.

Figure 2a shows a simulation under an incandescent lamp, while figure 2b shows the simulation of the same ambient setup illuminated by a neodymium (full spectrum) lamp, and figure 2c the simulates the same setup illuminated from Cool White FL lamp.

Software simulation can permit evaluation of color rendering and saturation (e.g. Figure 2c shows poor red). The simulation also permits the evaluation of differences in white at the approximate same CCT (Figure 2a vs. Figure 2b). – It shows that when Duv is too positive or too negative; in this case white becomes reddish like in Figure 2b. It also allows evaluating the right mix from chromatic and achromatic elements for the right ambience.

Figure 2:
(a) Incandescent simulation, (b) neodymium simulation, and (c) cool white FL simulation



Figure 3:

(a) CRI 97 LED
with CCT = 3,000 K,
(b) HD Retina LED,
(c) CRI >,80 LED
with CCT = 4,000 K

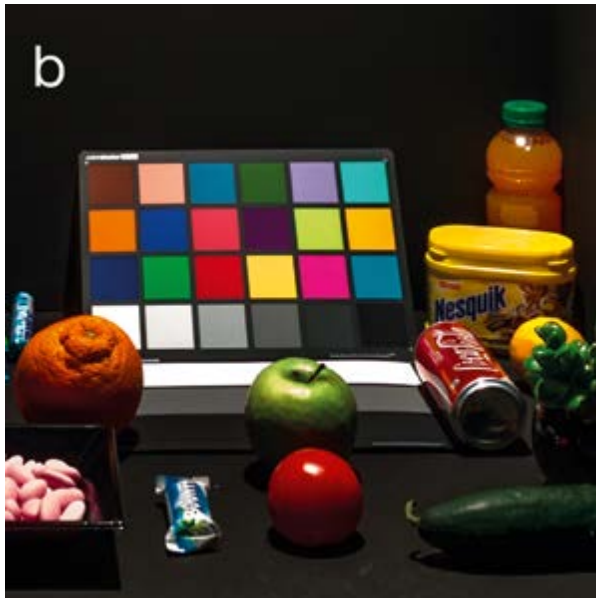
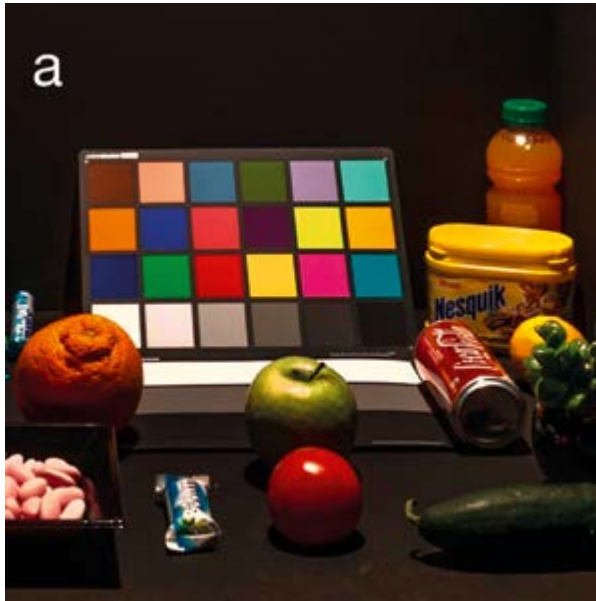

HD Retina Solution and Results

HD Retina LED was prototyped using the complete combination between both methods of measurement and digital visual simulation. First of all, visual simulation tests were conducted in order to identify the proper CCT target for the project. Once the choice of CCT (between 3,500 K and 3,700 K) was completed, the process for optimizing measurement methods was started, altering parameters, step by step, in order to produce a new set of spectral data. Each new generated spectrum was returned in the simulation and the feedback process loop until all the methods were satisfied. The final measurement and digital simulation results of the process generate a revolutionary patented light spectrum which saturates – at the same time and with a perfect balance – both warm and cold colors.

Integration of the calculated spectrum in an LED whit Chip on Board (COB) technology has led to the HD Retina LED that generates a pleasant light, able to render the true colors of the objects. Through innovative technology, the light source provides the ideal chromatic information which is part of the human evolutionary memory.

HD Retina LED is a light source which enhances the color perception of the human visual perception system throughout different situations and scenarios. For this reason it is a light source suitable for several applications; in particular, for all those where it is necessary to light up several different colored objects together, but getting perfect and balanced color saturation.

Figure 3 and 4 demonstrate the ability of HD Retina LED to improve actual LED light sources by providing a better ambient vision, a good color saturation and good white compared to LED light sources with different CCT and also very high CRI (97).

Conclusions

The newly developed simulation algorithms and development process allowed a good prediction of the final product parameters and led to a new light source concept. HD Retina LEDs get high scores based on the MCRI Index (memory color rendering index), a particular index considering not only color saturation, but also color memory perceptions made by the human mind. The perfect saturation both of warm and cold colors is completed by a “true white” – keeping a natural and clear impression, which gives and enhances an “unexpected and pleasant” visual comfort. ■



Touch the technology

GL SPECTIS 1.0 touch
Introducing world's first smart spectrometer.

If you need to measure:

- **Lux** – illumination value
- **Lumen** – the luminous flux
- **CRI** – color rendering index according to CIE
- **CCT** – correlated color temperature according to CIE standard
- **COLOR** – color coordinates according to CIE 1931 and CIE 1964
- **mWatt** – radiant power value.



www.gloptic.com

GL OPTIC Light measurement solutions



M90 Ceramic LED

- Highest flux density and reliability
- Ideal for outdoor, retail, industrial and commercial



M63 RGBW LED

- Red, green, blue and white in a single package
- Ideal for entertainment and architectural lighting



COB LED series

- Direct die bonding to copper
- Highest power and reliability
- Ideal for outdoor, industrial and commercial lighting

10W 15W 100W

References:

- [1] CIE 13.3:1995, Method of Measuring and Specifying Color Rendering Properties of Light Sources.
- [2] CIE 135/2:1999, Color rendering (TC 1-33 closing remarks).
- [3] J. Schanda and N. Sandor: Color rendering, Past – Present – Future, Proc. International Lighting and Color Conf., 50th anniversary of SANCI, 2-5 Nov. 2003 Cape Town, SA, pp. 76-85.
- [4] W. Davis and Y. Ohno: Color quality scale, Opt. Eng. 49(3), 033602 (2010).
- [5] K. Smet, W. R. Ryckaert, M. R. Pointer, G. Deconinck, and P. Hanselaer: Memory colors and color quality evaluation of conventional and solid-state lamps, Opt. Express 18(25), 26229–26244 (2010).
- [6] K. Smet, W.R. Ryckaert, M.R. Pointer, G. Deconinck, and P. Hanselaer, (2010): Color Appearance Rating of Familiar Real Objects.
- [7] Smet KAG, Ryckaert WR, Pointer MR, Deconinck G, Hanselaer P: A memory color quality metric for white light sources, Energy and Building, 2012; 49(C):216-25.
- [8] Smet KAG, Ryckaert WR, Pointer MR, Deconinck G, Hanselaer P: Correlation between color quality metric predictions and visual appreciation of light sources, Optics Express, 2011; 19(9):8151-66.
- [9] Jost-Boissard S, Fontoynt M, Blanc-Gonnet J: Thurstone scalings for attractiveness of fruit and vegetables under nine 3000 K and eight 4000 K light sources, (personal communication), 2009.
- [10] Jost-Boissard S, Fontoynt M, Blanc-Gonnet J: Perceived lighting quality of LED sources for the presentation of fruit and vegetables, Journal of Modern Optics, 2009; 56(13):1420-32.
- [11] Smet KAG, Ryckaert WR, Pointer MR, Deconinck G, Hanselaer P: Memory colors and color quality evaluation of conventional and solid-state lamps, Optics Express, Dec 2010; 18(25):26229-44. PubMed PMID: WOS:000285749500080.
- [12] Rea MS, Freyssinier JP: Color rendering: Beyond pride and prejudice, Col Res Appl. 2010; 35(6):401-9.
- [13] Smet KAG, Ryckaert WR, Pointer MR, Deconinck G, Hanselaer P: Memory colours and colour quality evaluation of conventional and solid-state lamps, Optics Express, December 6, 2010; 18(25):26229-44.
- [14] Narendran N, Deng L: Color Rendering Properties of LED Light Sources, Solid State Lighting II: Proceedings of SPIE2002.
- [15] Rea MS, Freyssinier-Nova JP: Color rendering: A tale of two metrics, Col Res Appl. 2008;33(3):192-202.
- [16] Schanda J, Madár G, editors. Light Source Quality Assessment. CIE 26th Session 2007; 2007; Beijing, China: CIE.
- [17] Szabó F, Csuti P, Schanda J: Color Preference under Different Illuminants – New Approach of Light Source Color Quality. Light and Lighting Conference with Special Emphasis on LEDs and Solid State Lighting; May 27-29, 2009; Budapest, Hungary; CIE; 2009. p. PWDAS-43.
- [18] Vanrie J: Appendix 4: Technical report to the user committee of the IWT-TETRA project (80163): The effect of the spectral composition of a light source on the visual appreciation of a composite object set. Diepenbeek, Belgium: PHL, 2009 June 11th, 2009. Report No.

Light Quality and Appropriate Light Measuring Methods in Demanding Applications

From the time LED lighting made its grand entrance in broadcasting and film making, it has become more and more popular. Rich Rosen, director of engineering at Litepanels - the first company to introduce professional LED lighting for broadcasting and motion picture industries - explains the requirements of the movie and broadcasting industry and how and why LED lights may soon dominate this field of application.

No lighting application is more demanding than broadcasting and television production. Lighting plays a pivotal role in the quality and consistency of filming, setting a scene and overall aesthetics. Traditionally tungsten, halogen and HMI lighting has been used in filming to create moods, imitate daylight and frame the perfect shot. However, the selection of LED lighting fixtures is quickly becoming the first choice. With the advances in technology, it is exceeding the quality expected from conventional lighting with numerous additional benefits.

On Location Lighting

Filming content on location provides unique challenges to the lighting designer and director. Generally, they have less control over the environment they have to illuminate. It's not always possible to place lighting fixtures in the ideal location, the varying surfaces in terms of color and reflectiveness need to be taken into account, and the amount of natural light that is available will change throughout the day, so lighting design needs careful consideration. Fixtures for these conditions need to be mobile, durable and easy to control. Power is also an essential element. There is less flexibility on location so careful

attention needs to be given to how the lights are powered, whether that is from the grid, generators or battery packs.

Outside Broadcast Lighting

Generally, outside broadcasts are reserved for live events such as sports or news. The main purpose of the lighting fixtures in these cases is purely to light the subject so viewers at home can clearly follow the action. While most sports venues will have their own lighting, there is still a requirement to light presenters and interviewees. For example, in announcer booths at sports events the lighting technicians face the challenge of maintaining a perfect match between the studio lighting and light on the announcers from the venue behind them, taking into account weather conditions and changes to the quality of light over the course of the day. The key is to have a focusable and dimmable lighting source to provide the technicians with the required control to cut the light exactly where it is needed and adjust the intensity. Outside broadcast lighting has similar requirements to on location lighting, but with the added complication of needing to be robust and highly mobile as lights are being moved from location to location on a regular basis. Broadcasters operating in this environment need lights that are

Figure 1:
Studio lighting has high quality requirements



Table 1:
The significant variations in energy output of the key lighting platforms

	Tungsten	HMI	Fluorescent	LED
Lamp life	200-350h	500-750h	2,000 – 10,000	25,000 – 50,000
Energy consumption	Very High	High	Medium / Low	Very low
Heat output	Very High	High	Medium / Low	Very low

compact, lightweight, have short strike times and do not require a large amount of extra appliances to enable them to work.

Figure 1:
On location lighting has also high quality requirements, but adds the need for flexibility, often dimming and sometimes color adaptation to the list of requirements



The Benefits of LED Lighting

The use of LED lighting as a single source LED or multiple array, offers significant benefits. The most common advantage is cost-effectiveness as the lights have a longer life span and due to decreased heat output less air conditioning is needed. From an environmental perspective, consider that calculations show that tungsten-based lighting in a single newscast studio can dump a staggering 200,000+ lbs. of CO₂ into the atmosphere annually. Energy efficiency of the bulbs themselves is a further benefit and in instances can use up to 85 per cent less than tungsten lighting. Other benefits include increased comfort levels, less glare for actors and presenters, and the lights themselves weigh less than traditional tungsten lights (Table 1 illustrates the significant variations in energy output of the key lighting platforms).

However, regardless of the type of lighting used, the requirements for high performance solutions remain a top priority. So how is this achieved with LED lighting?

Innovation

LED lighting has developed in leaps and bounds over the last few years with many companies, finding success through innovation, and pushing the performance envelop. Establishing relationships with LED manufacturers is an integral part of the design process. This point of differentiation ensures that the products are rarely “off the shelf” or ordered from a catalogue. Instead, engineering teams work closely with LED manufacturers to develop leading-edge LED products based on the latest technology advances.

What Makes a High Performing LED

Simply put, a high performing LED must encompass high quality components, including the LED die, phosphors and structural materials. The highest quality controls need to be in place from design through to assembly. In a recommended three stage process, LEDs are tested at the manufacturer, again prior to assembly, and final photometrics testing is performed after assembly.

Ensuring Light Quality

Tungsten lighting has traditionally dominated the lighting marketing. However, as LED lighting has evolved, high quality LED fixtures now offer better stability in terms of color temperature and performance, and exceed the vigorous requirements of lighting technicians. The best strategy is to develop and select LEDs with the highest ability to render all colors from the lit subject. This typically translates to LEDs with what is commonly known as high CRI values. With the advances in phosphor technology, manufacturers are now able to develop all lights with CRI values in the mid to upper 90s, with the highest rating being 100.

Close relationships with lens designers and fabricators is mandatory to ensure

that the lensing of the LED product range is flawless. The high quality lensing further ensures that the light beam patterns have a homogenous feel, there are smooth fall offs, and there are no chromatic aberrations. The company custom molds the lensing for the LEDs based on customer requirements.

Thermal Management

Although LEDs are much more efficient than incandescent bulbs, they do generate heat. A 2-kW equivalent LED Fresnel will generate over 200 watts of heat. That heat must be delivered to the world outside of the fixture. Since the lifespans of LEDs and the driving electronics are dependent upon controlled temperatures, great care must be taken to expel that heat.

Thermal management, or temperature regulation, is a specific focus when it comes to the design and manufacture of LED fixtures and nearly half of all design time is dedicated to this process. There are many different topologies for heat exchange, and in the more demanding situation of a Fresnel light, a heat sink is used to extract the heat from the LED. Specially selected fans are used to blow the heat off the heat sink, where it is then channeled to the outside. In the higher output Fresnels, omnidirectional heat pipes are used to aid the heat flow from the LED, to the fins of the heat sinks.

Traditionally the use of fans, especially in LED Fresnel lights, was strictly taboo due to the noise of the fan and reliability concerns. However, ultra-quiet bearing-less fans featuring laminar blade design emit an almost undetectable amount of noise. The result is that the use of fans in Fresnel lighting fixtures has become standard practice in the industry and can be used to excellent effect if they are well designed and run at sufficiently low speeds.

For Fresnels chip on board (COB) technology which is designed per individual application in conjunction with the LED manufacturer is the preferable choice. COB LEDs are a special case for thermal management in that so many Lumens are generated from a very small area. And with Lumen density comes heat density. Special heat conductants that do not degrade over time are needed to assure low LED temperatures as the fixture ages.

LED Light Fixture Dimming

In applications such as broadcasting and filmmaking, light intensity values are stringent and must be managed precisely in order to meet the needs of lighting technicians and directors. When LED lighting is used for these industries, management of the fixtures – that is several LEDs lights making up specific lighting configurations, such as fill, back and key lighting – becomes crucial.

Inexpensive or less sophisticated LED fixtures often utilize pulse width modulation (PWM) to control the dimming levels of their fixtures. This is a questionable design choice as these PWM frequencies can easily interfere with the shutter speeds of modern cameras, and produce a banding or pulsing effect in the image. However, by avoiding the use of off the shelf LED drivers, and opting instead for microcontrollers, it has proven to be the better solution to achieve the best possible perceived analogue dimming. The use of a microcontroller as the heart of the LED driver allows flexibility in the dimming profile, as well as the monitoring of other system variables, such as LED temperature and DMX control functions. LED Lumen output is not linear through its entire dimming range, especially at low LED output levels. Years of experience are crucial to understand where it is necessary to deviate from linear response to achieve the best perceived linearity.

Measuring Light Quality

There are two product types to distinguish; products that fall in either the 3,200 K tungsten replacement

range or HMI 5,600 K replacement range. The tungsten replacement range features warm white lighting, while the HMI replacement lighting features cooler daylight tonal range. As mentioned previously, these products feature a CRI of more than 90. To ensure that these so-called replacement lights offer the same light quality as the tungsten lights, careful attention is paid to the phosphor chemistry. Phosphors are therefore selected with the appropriate color bin that falls within the targeted area for replacement. Some companies, including Litepanels, will direct the LED manufacturer to use custom color binning to fit the application.

About color rendering and CRI

Other LED lighting vendors in the broadcasting and film making markets produce lights which use a combination of red, green and blue LEDs. This is referred to as RGB lighting. Just as the pixels on an old tube television can combine RGB light emissions to create a white light as detected by the human brain, RGB lights do the same. The real problem is that we use lighting to illuminate images, whose colors are reflected back to the cameras. If the image has a color that is not in the very discontinuous spectrum of an RGB light (or fluorescent light for that matter), that color will be detected with great attenuation. Cameras can balance color if the color is there. If the color is absent, only specialized post production can simulate the missing color. Continuous-spectrum light sources are the ideal for image capture.

CRI is the measure of the whiteness or continuity of the light. The sun, measured without the effects of the atmosphere, has a CRI of 100 per cent. A tungsten bulb has a very continuous spectrum and also measures at or near 100 per cent CRI. LEDs with specialized phosphors can achieve CRIs as high as 98 per cent.

Some LED fixture developers may use standard white LEDs, interspersed with a number of red, green and blue LED “pixels” to create a more even

frequency response and fool the CRI readings. In practice, to get close to the ideal tones some also need some amber, so they end up with five different colored points of light in the fixture (RGBWA). To create the idealized spectrum they have to reduce the light output: you cannot turn LEDs up over 100, so you have to bring some down to the balance point, which potentially leads to dimming a majority of them. The philosophy of high quality manufacturers is to remain abreast of technology trends and to invest sourcing in the optimal materials in order to create the idealized light source.

Television lighting consistency index - TLCI

With the increased use of LED lighting in television production there has been a call for a different standard of measurement as CRI may not be entirely appropriate to this industry. In November 2012 the EBU Technical Committee approved a recommendation which effectively validated the Television Lighting Consistency Index (TLCI). CRI supports a floating white point or variable color temperatures which may be used for creative, as well as compensatory reasons. TLCI is aimed at a standard camera model, to ensure consistency between studios and productions.

However, TLCI is not merely a measurement of the luminaire, as CRI is, but of the complete system from light source through the camera to the display, using only those specific features of cameras and displays that affect color performance.

Conclusion

LED lighting is revolutionizing film production and broadcasting and offers these industries inherent benefits. Light plays a significant role in this industry and as such must meet the exacting standards of film making professionals, most notably light quality. The key, therefore, to meeting these demanding requirements is the careful design of the LED and support system of the LED. ■



LED Lighting Taiwan

The 10th Int'l LED Lighting Exposition
www.optotaiwan.com

June 17-19, 2014

TWTC Nangang Exhibition Hall

VIP BUYERS Inviting!

Free Hotel Accommodation

Exhibits

■ **LED / OLED Light Source, Package / Module/ Engine**

LED Epi Wafer / Chip
OLED Components,
LED Package, LED Module / Engine,
OLED Module / Engine

■ **LED / OLED Lighting Fixture**

Technical Lighting, Decorative Lighting
Accessories and Electronic Components

■ **LED Applications**

Backlight, Automobile, Display Board
Traffic Signal, Projector, IrDA, IR / UV Lights, Others

■ **LED / OLED Materials**

LED Materials
OLED Materials

■ **LED / OLED Equipment**

LED Equipment
OLED Equipment

Organizers



Photonics Industry & Technology Development Association
5F, No 9, Sec 2, Roosevelt Road, Taipei 10093, Taiwan
Tel : +886-2-2351-4026 Fax : +886-2-2396-8513
[Overseas contact]
Sean Su (ext. 883) E-mail : sean.su@mail.pida.org.tw



Taiwan LED Lighting Industry Association



INTERNATIONAL EDITION
OPTOLINK
"Taiwan Photonics Trend and Meet"
http://www.pida.org.tw/OIE

www.LEDChina-gz.com



The World's Largest LED Event

23 - 26 February 2014

China Import and Export Fair Pazhou Complex,
Area B, Guangzhou

- 80,000 sqm in exhibition space
- 1,200 exhibitors and brands
- 80,000 domestic & overseas visitors

(The above are projected numbers)



LED CHINA 2014

Contact

UBM Korea Corporation
T 82 2 6715 5406
F 82 2 432 5885
E jameshj.lee@ubm.com

Organiser

UBM Trust Co Ltd
T 86 20 3810 6261
F 86 20 3810 6200
E led-trust@ubm.com

Our Network

Japan T 81 3 5296 1020
E tatsuo.ide@ubm.com
Taiwan T 886 2 2738 3898
E info-tw@ubm.com

USA T 1 516 562 7855
E cecilia.wun@ubm.com



Manufacturing Silicone Lenses and LED Packaging

The increasing power capabilities of LEDs are also challenging other components, like optics. This is especially due to thermal stress. Silicone based materials offer performance and reliability advantages in LED lighting applications but they need special knowledge and manufacturing skills. Tarik Karsandik from Tengifts Technology explains the silicone optic lens injection molding process, specifications and properties of silicone injection lens molding machines, equipment and tools.

The performance of the LED lighting industry has made unprecedented leaps over the last five years and has the potential to grow even faster in the next decade. Currently, LED lights cover 18% of the global lighting market. A report on the lighting industry indicates that over 70% of lighting worldwide will be LED-based by 2020.

Arguably, the LED lighting market in many countries remains highly fragmented. However, the medium to long term growth potential of the LED lighting market still carries considerable promise, driven by cost declines, regulatory incentives and rapidly increasing consumer awareness.

Over the course of the last five years the LED industry has been supplying the market with increasingly smaller compact designs, brighter luminaries and LED lighting products such as HP/UV LEDs.

Solid-state-lighting has great benefits over conventional lighting, such as energy consumption and long lifetime. However, heat is negatively affecting reliability and the lifetime of these high performance LEDs.

The ever-increasing thermal issue of high performance LEDs that challenged the emerging lighting segment brought silicone based materials to the attention of optics manufacturers. The industry has started exploring new materials such as silicones that, while less familiar in LED applications, bring a rich history of proven performance in dozens of other industries including advanced electronics, automotive and communications. Silicone based materials are designed to improve performance and reliability of the LED. For instance, silicone provides a tremendous compensation of mechanical tolerance, high resistance at elevated temperatures, reduces the yellowing effect, and produces raised illumination and luminaries with deep clarity.

There are different types of silicone molding processes available such as injection molding, dispensing, compressing, transfer molding and vacuum molding. Each molding process certainly has its benefits and difficulties throughout the process. However, the injection molding process differentiates itself by using no viscose silicone materials, which provides technical advantages and significant cost effectiveness.

Silicone materials seem to be the better choice for led optics and for component applications. There are

four key steps for successful LED packaging and the silicone optic lens manufacturing process.

The four manufacturing steps:

- Silicone optic lens injection molding process
- Factors affecting the packaging quality
- Reliability and durability tests
- Specifications and properties of silicone injection lens molding machines, equipment and tools

The Injection Molding Process

The behavior and form of the two materials differ during the plastic and silicone molding processes. The raw material, plastic, is in a granulated form before injection. In order to make it ready for the injection process it must be heated up. The melted raw material is then injected into the cooled mold.

The silicone molding process starts in a fluid form and high viscosity silicone material (A) and hardener (B) are mixed in during the cool, screw-spinning part to keep the silicone in liquid form before injection. Since it is a high-performance material it easily withstands temperatures of 150°C and higher without significant loss of optical or mechanical performance. Also, moldable silicones retain their

Figure 1 (left):
Typical steps
within a silicone
lens molding
system

Figure 2 (right):
Overview of a
well-designed
silicone lens
molding process

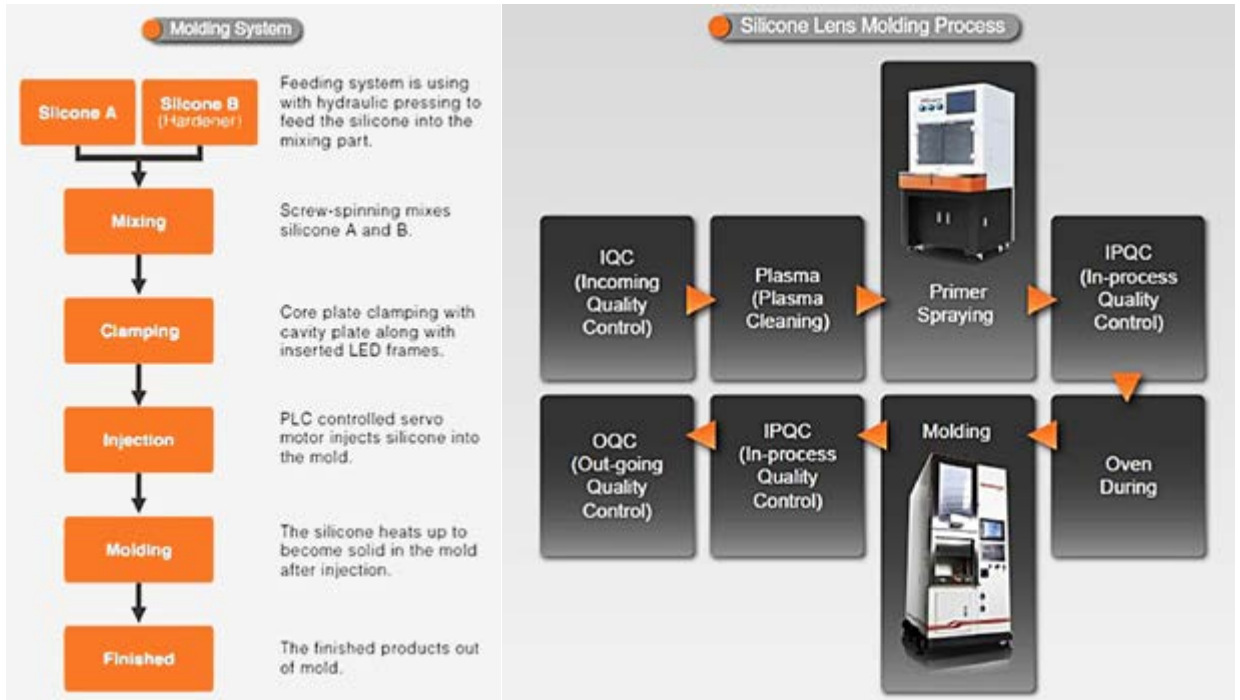

excellent optical stability and transparency even after prolonged exposure to temperatures upwards of 150°C, exhibiting comparatively little or no yellowing and greater reliability across the visible spectrum; in comparison to conventional plastic materials which decline over time at temperatures above 90°C.

Indeed, this emerging class of silicones enables LED optical components to maintain their lumen output and efficiency better over the course of an LED’s useful lifetime.

Packaging Quality

During the packaging process; substrate material, primer material, silicone material and process operating parameters show different reactions based upon LED types such as COB, MCPCB, SMD, PLCC, RGB, K2 and Ceramic.

There are five important points that need to be considered in order to have high quality packaging. Substrate material quality is one point. The substrate’s thickness should be ±0.025 mm. Inconsistency of the substrate’s thickness will cause a broken substrate and a silicone leak in the process. The structure of the substrate and / or having a hole in the substrate will

affect the mold design and the molding injection. Fluorescent quality during the spraying and dispensing processes (making sure that the silicone and primer go with the phosphor to prevent peeling). Spraying and dispensing materials quality (the spray gun plays a vital role when it comes to spraying the primer evenly on the surface of the substrate to prevent part of the silicone from peeling). Surface cleanliness; by preventing dust and keeping the humidity rate low. The quality of the wire and die bonding have a significant effect on the packaging quality.

During the molding process it is best to take samples, check the wire and die bonding and semi-packed LED quality and quantity.

After that, the semi-finished LED frames can be placed in warmed ovens for dehumidification of the LED surface during the baking process.

After dehumidification the semi-packed LED surface will be cleaned from dust and airborne particles by a plasma-cleaning machine.

After the plasma cleaning process, the semi-packed LEDs are moved to the primer spraying stage so the LED

surface can be sprayed and attain the bonding function for non-viscose silicone material.

After the primer spraying operations it is advised to test and inspect the quality of the spraying process and confirm primer spray conditions with an in-process quality control step.

During the molding stage, customized, highly sensitive and accurate molding tools are used for accurate lens production with different shapes, sizes and angles for the LED silicone lens requirements. During an in-process quality control the condition of the silicone lens, the shapes, bubble rate, silicone hardness rate and silicone bonding rate are confirmed.

The finished silicone LED lenses and packed LED lead frames or maps should be check before shipment to guarantee the best quality.

Reliability and Durability

Based on environmental conditions, different reliability and durability specifications need to be applied to various types of LEDs. The reliability tests and durability tests specs will also have different results based on conditional situations.

The following are five reliability and durability steps:

- Silicone hardness: Silicone A & B Mixed Health Test
 - Hardness Test: The hardness testing confirms that the mixing ratio of A & B material is correct and mixed evenly. An incorrect or uneven mixing ratio will cause irregular hardness in the resulting colloid cutting.
 - Adhesion strength test: This is a pull and/or thrust test to assure the attachment is sturdy and the substrate bonding strength is sufficient.
- Structural Testing: The test for IR reflow temperature (260°C), to simulate the process of SMT soldering operation. It begins with a high temperature and humidity environment (85°C with 85% RH or 60°C with 90% RH). After that, the testing goes on to -40°C to 85°C to confirm the actual corruption in practical use.
- LENS pull or shear: Silicone adhesive strength test for pulling or shearing.
 - LED characteristic test: This test is based on light types testing as well as optical efficiency tests.
 - IR Reflow test: SMT high temperature structural reliability tests.
 - Thermal Shock Test: Ambient temperature structural reliability tests.

Equipment Specifications and Properties

The machine start up time (mold heat up) as well as the amount of waste raw silicone material has a significant effect on production costs and capacity. There are four key molding tools and pieces of equipment that help to shape and produce high quality silicone production.

The four single machines:

- Primer Sprayer Machine - is used for spraying frames or maps to attain the bonding function for non-viscose silicone material
- Water Cooling Machine - is used to prevent the hardening of A and B material prior to the injection process
- Baking Oven - humidity weather conditions used for the dehumidification process.
- Plasma Cleaner – cleans surfaces

It is commonly acknowledged that optical design and reflection rate are the key steps for lighting. Therefore, highly sensitive molding equipment and tools are needed for accurate lens production with different shapes, sizes and angles for the LED silicon lens requirements.

During the injection process, the molding machine allows you to inject the silicone accurately so you can have customized lens angels and shapes of from 30 degrees to 140

degrees. It is also applicable to light guides, primary optics, secondary optics, chip encapsulates and silicone components.

Conclusions

To provide high quality silicone based optics, it is important to understand the process and have good control mechanisms during the whole process. Handling silicones is challenging but when done correctly it offers many advantages over other optical materials for LED lighting issues. ■

Figure 3:
Simplified system of silicone lens molding equipment consisting of four machines

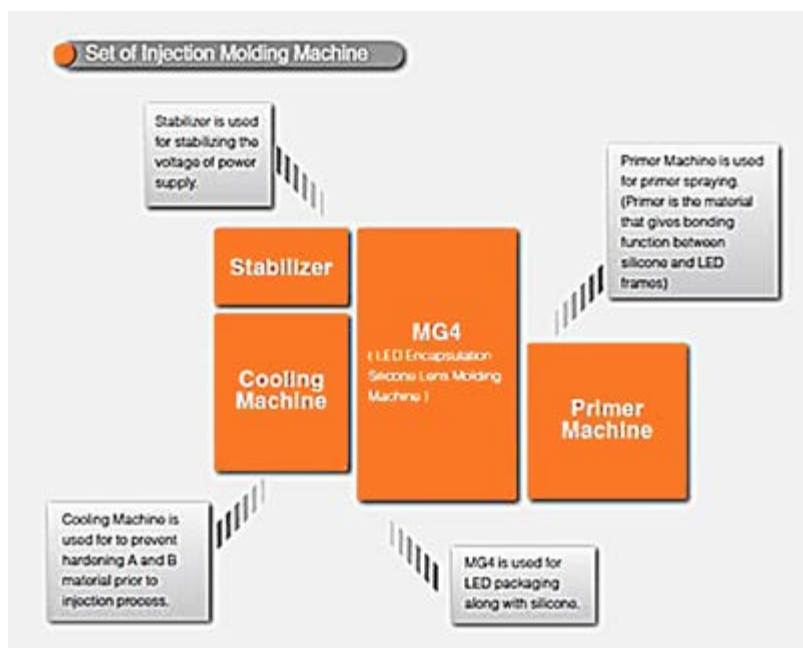

TAIWAN INT'L TILS LIGHTING SHOW

Taiwan's Foremost LED Lighting Event!

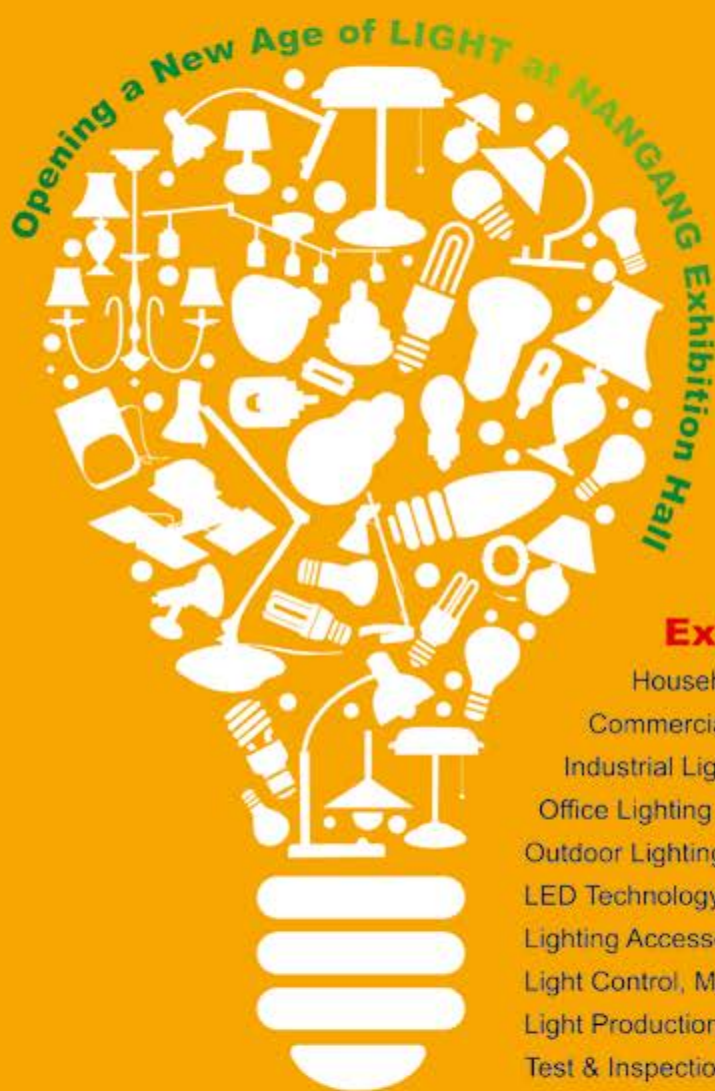

Exhibits Profile

- Household Lighting
- Commercial Lighting
- Industrial Lighting
- Office Lighting
- Outdoor Lighting
- LED Technology
- Lighting Accessories, Parts & Components
- Light Control, Management and Measurement Systems
- Light Production and Measurement Equipment
- Test & Inspection Equipment

MAR. 20-23
2014

TWTC NANGANG Exhibition Hall

www.TILS.com.tw

For further information, please find your nearest TAITRA office online:
<http://branch.taiwantrade.com.tw>



Organized by:

Bureau of Foreign Trade, MOEA



Implemented by:

TAITRA
www.taipei-tradeshows.com.tw



TLFEA
www.lighting.org.tw



Supported by:

China Economic News Service

Key Technologies – Drivers of the (LED) Lighting Market

Traditionally, the more than 100-year-old electric lighting market has been dominated by a small number of incumbent players including Phillips, Osram, GE and Zumtobel. Until recently, they have enjoyed a 60% to 70% combined market share. A new research report from memoori Business Intelligence demonstrates that with the arrival of commercially viable LED lighting, the lighting market for buildings is in a period of transformation not seen since the days of Edison and Westinghouse. Arno Grabher-Meyer, Chief Editor at LED professional picked out the technology based findings of the report to discuss the key drivers and future developments.

While LED lighting is recognized as the lighting of the future, adoption is advancing relatively slowly. Drivers can be classified into those that are speeding up the market and those that are slowing down the market but in the long run they both lead to saturation of the market. Positive key market drivers and key issues have improved cost competitiveness and ROI as well as light performance. Other parameters like population growth and urbanization, construction and floor space growth, as well as regulatory measures that depend on governments also have positive effects on the market. Most of these factors do not boost the LED lighting market specifically but rather, the overall lighting market. Although we don't see it today, drivers with the inhibiting effect of heavy price pressure combined with a cannibalistic-like saturation of the replacement market will have to be taken into account in the future.

While the drivers for the overall lighting market are mainly non-technical external ones, there are additional drivers for LED lighting that are mostly related to technical issues. On the other hand, there are also clear barriers and challenges to be taken into account. A persistent lack of information and awareness, consumer mistrust and quality concerns due to bad experiences with misleading and wrong performance data are the most critical issues. Technical challenges are also often argued to be limiting market adoption. To verify or invalidate this argument it is necessary to identify these challenges correctly and to analyze them (Table 1).

A closer look at table 1 shows that these challenges may cause technicians some sleepless nights.

However, there are solutions available for most of them and for the rest, there is a solution on the horizon. The technologies and solutions have emerged to a level that allows us to fully agree with Eric Peeters, vice president of Dow Corning Electronic Solutions, who said: "None of these emerging application challenges represent a showstopper for the next-generation of LED lighting designs. But the next wave of breakthrough solutions will only occur through close collaboration between designers, manufacturers and material developers."

Seen from this angle, one can concentrate on technologies as described in the report with a potential to foster the lighting business from now to 2017.

Figure 1:
The current transition from no control to full control of light that is occurring in the smart lighting space (Source: Vireak Ly, Program Manager at Southern California Edison)



Table 1:
This table of the memoori report lists and describes the major challenges

Thermal management	Unlike traditional incandescent lighting, LED lamps require conductive cooling. Whilst LEDs run cooler than most other lighting technologies, it is a common misconception that they run without generating heat. While LEDs will not burn skin like some lighting products, only 20 to 30 percent of the power created by white LEDs is actually converted into visible light (lumen); the rest, 70 to 80 percent, is converted to heat. Excess heat affects both the short- and long-term performance of LEDs. Operating an LED at high temperature results in lower initial light output and a much shorter life. The failure rate for most electronic components will double for every 10 °C increase in temperature. Manufacturers are looking at 3 different areas to improve the thermal performance of LEDs, these are i) Substrate Materials, ii) Interface Materials and iii) Heat sinks.
LED Droop	LEDs operate most efficiently at low currents; as the current increases, efficiency is reduced by a mysterious droop effect. Scientists have long theorized the root cause of this effect. Droop reduction has been identified as one of the keys to improving efficiencies, generating increased Lumen outputs, and reducing the cooling requirements for LED lamps and Luminaires. Researchers at the University of California, Santa Barbara and colleagues at the École Polytechnique in France now claim they have identified “Auger recombination” as the mechanism that causes LEDs to be less efficient at high drive currents. Knowledge gained from this study is expected to result in new ways to design LEDs that could have significantly higher light emission efficiencies. LEDs have enormous potential for providing long-lived high quality efficient sources of lighting for residential and commercial applications.
Dimming	In theory, LEDs are easily and fully dimmable, because unlike fluorescent light sources there is nothing inherent in their makeup that would impede the dimming process. LED lighting products are therefore often touted as fully dimmable, but that claim is frequently contradicted by real-world experience, especially with phase-cut dimmers, which were designed for incandescent lighting and thus can be incompatible with LED drivers. The industry is aware of the problems associated with dimming LED light sources and is addressing them with new standards. The DOE has supported efforts led by the NEMA to develop manufacturer dimming guidance and standards for SSL.
Driver Efficiency	LEDs require a driver that is comprised of both a power source and electronic control circuitry. Most drivers convert line voltage to low voltage and current from AC to DC, and may also include supplementary electronics for dimming and/or color correction. The LED drivers that currently available are typically about 85% efficient, with some improvement projected.
Binning and Color Consistency	Binning is a term used to describe the categorizing of LED chips by quality. When LED dies are manufactured, they are essentially punched out from one larger “master” chip. At the center of this ‘master chip’ there is generally a higher concentration of phosphors and this generally leads to better light output and higher lumens compared to chips from the edge of the master chip. Effective binning processes are not only costly, but can also increase the lead time on the delivery of LED die orders. In 2008, ANSI and NEMA collaborated to establish new binning standards which have become a minimum requirement for Energy Star® certification.
Energy Intensive Production Process	The LED production process is energy intensive and although the end products do not generally contain hazardous chemicals, the manufacturing process does. Moreover, the majority of LEDs are produced in countries with significantly lower standards regarding labor rights and environmental standards.
Temperature Dependence	LED performance largely depends on the ambient temperature of the operating environment. Most manufacturers’ published ratings of LEDs are for an operating temperature of 25 °C. Over-driving the LED in higher ambient temperatures may result in overheating of the system, eventually leading to device failure. By contrast LED light output rises at lower temperatures, leveling off, depending on type, at around –30 °C. However, because they emit little heat, ice and snow may build up on the LED luminaire in colder climates.
System Complexity can Impact Reliability	LED lamps and luminaire systems include many components, such as the driver, optics, housing and thermal management in addition to the LEDs. A critical failure can occur in any of these components, which means it is not easy to measure the overall system reliability and lifetime, which are important to end-users. In fact, a study by Appalacian Lighting Systems concluded that over 90% of luminaire failures were due to something other than the LED itself, with 52% of failures occurring at the driver level. Standardization and improved testing regimes are helping to alleviate these issues.

memoori's Top 7 of Potential Key Technologies

Smart lighting

Smart lighting means using lighting control systems on various parameters. It can provide the ability to manage every aspect of the lighting system – setting operating hours, brightness and dimming levels, how

long lights stay on and more. It can even integrate with sensors to monitor factors such as occupancy, movement, color temperature and amount of natural light / daylight.

Initial Situation: Today, smart lighting systems are used in a very low percentage of buildings. LED lightings’ controllability nature makes it well

suited for use with sensors in smart lighting applications for a number of purposes including increasing energy savings. New infrared sensor technologies capable of detecting stationary heat-emitting objects are also emerging.

Target Groups: Deployment of smart lighting is of particular interest to

building owners, governments, utilities, and many other stakeholders as it can help to further reduce energy consumption. Controls can allow perceived light quality to match lighting codes precisely and allow LEDs to be powered at lower current levels, extending their lifespan as dimming an LED makes it run cooler, which in turn makes it more efficient and reduces depreciation. Some manufacturers claim potential savings of 30 % to 70% on building lighting costs over and above those achieved by LED alone by installing smart lighting systems, and a payback period of 2 to 5 years.

Applications and Benefits: Besides energy efficiency, several companies have also begun to focus on wireless lighting control systems. Installation of wireless lighting control systems is relatively easy, as it does not involve modification to existing structures.

Another application of smart lighting that is emerging is remote control, particularly mobile phone and tablet controlled dimming. An advantage of this technology is the ability to dim without a dimming enabled switch.

There's also potential due to the functionality of LEDs that will allow users to control an LED's visible spectrum, which makes it possible to change chromaticity; not just for aesthetic reasons, but also to optimize our mood, productivity and health.

Such applications are proving particularly popular in nightclubs where the lighting scheme can be automated to color change in time with the music. Philips also recently launched the "Lighting Hue SSL retrofit lamp" which can provide 16 million colors and tunable white light with ZigBee-based control via smartphones and tablets.

State-of-the-Art: LED Technology offered new options for Smart Lighting, or the controls business. Besides the established lighting and controls network standards like DALI, LON, KNX, several new approaches, like wireless systems, are coming up.

In March 2012 the ZigBee alliance ratified the Light Link standard that offers wireless control for LED lighting. The alliance claims that energy efficient light bulbs, LED fixtures, sensors, timers, remotes and switches built using ZigBee Light Link will connect into a single network, without special devices to coordinate the network. Consumers will be able to install products and add extra devices to their lighting network.

Market prospects: The market for smart lighting is growing at a rate equivalent to that of LED lighting. According to recently published research from RnR Market Research "The growth of the smart lighting market is expected to be remarkable with the revenue increasing from \$1,070 million in 2012 to \$6,747 million by 2018, at an estimated CAGR of 36% from 2013 to 2018." However, contrary to the LED manufacturing market, entry barriers are low and many new players are arriving in this market (because it is mainly software orientated).

The major established players in the smart lighting industry include Lutron, Philips, Osram, Schneider, Zumtobel, Acquity Brands, and Legrand, whilst recent new entrants include NXP Semiconductors, Digital Lumens and Redwood Systems.

OLED

Today's Organic Light Emitting Diodes (OLEDs) basically consist of a glass substrate and layers of organic semiconductors between a (transparent) electrode and counter-electrode. OLEDs are very thin (including the glass substrate and the encapsulation usually less than 2 mm) and are therefore very light, so they are considered to be highly marketable as surface light sources that allow a wide range of applications (transparent and flexible lighting) with various designs (Figure 2).

Initial Situation: To date, OLED revenue has been mainly generated in the display application space, particularly for smartphones and tablets, a technology that differs from OLED technology for lighting applications. An OLED screen is able to work without a backlight. This reduces the power consumption and size over LED screens, while producing extremely clear black levels and high contrast ratios, even when exposed to ambient light. Some in the OLED industry are now targeting the general lighting market.

Applications and Benefits: Despite the constraints above, as OLED panels emit light uniformly in all directions which offers potential for many new application areas, such as light walls, light tiles or windows, we do expect OLED to make gains in

Figure 2: Just one of a number of manufacturers, Philips used OLEDs at the Light & Building 2012 and caused a sensation (Credits: Philips)



some niche applications such as specialty and high end lighting given their design characteristics.

Market prospects: The low production volumes, relative immaturity of the industry and high R&D costs for OLED development mean high prices for OLED based lighting. Given current prices of \$1,700 per kilolumen (DOE April 2012); we feel that mass-market penetration in any of the major sectors of our report unlikely in the short to medium term. Furthermore, OLEDs have a still relatively short lifespan.

Alternative substrates

Gallium nitride (GaN) is generally the semiconductor material of choice for solid-state lighting. Made from half gallium and half nitrogen, GaN converts electrical impulses to light and is typically grown on the surface of wafer substrates of SiC or Al₂O₃ that are 50 mm, 75 mm, or 100 mm across. Several firms are pursuing R&D into the use of alternative substrates with the goal of lowering costs or improving performance based on the usage of cheaper substrates, or using substrates that allow for larger wafer sizes (Figure 3).

GaN-on-Si

Initial Situation: Firms including Plessey Semiconductors, Bridgelux (whose IP in this area was recently acquired by Toshiba) Azzuro Semiconductor, Translucent and Epistar claim to be close to developing or having available commercially viable LEDs based on gallium nitride on alternative silicon (GaN-on-Si) technology.

Challenge: According to materials science researcher Professor Sir Colin Humphreys of Cambridge University, depositing high-quality gallium nitride layers on silicon is tough, mainly because the materials expand and contract at very different rates when heated and cooled. The process is carried out at temperatures around 1,000°C, and, upon cooling, the gallium nitride cracks because it is under tension. If these stresses and strains are not dealt with as the GaN crystal grows on the silicon, the GaN degrades, limiting light emission and driving down efficiency.”

Benefits: The main allure of a silicon substrate is the potential lower cost, both in terms of materials and wafer size. Efforts to develop high brightness blue GaN LEDs on silicon date back 10 years, but until recently, efficiencies and wafer sizes significantly lagged behind those of commercial devices made on other substrates. Switching to 200-mm silicon would trim the LEDs' cost of materials, because such wafers are cheap and common.

Bridgelux has gone as far as to suggest that GaN-on-Si LEDs could offer a 75% cost reduction from conventional LEDs made using sapphire or silicon carbide substrates.

State-of-the-Art: The use of Plessey's MAGIC GaN line using standard semiconductor manufacturing processing provides yield entitlements of greater than 95% and fast processing times providing a significant cost advantage over sapphire and silicon carbide based solutions for LEDs of similar quality.

GaN-on-GaN

Initial Situation: Meanwhile Silicon Valley start-up Soraa has adopted an alternative approach, opting to invest its efforts in the development of a GaN-on-GaN process. According to Soraa CEO Eric Kim, the GaN-on-GaN LEDs suffer less droop (relative to initial efficiency) even when operated at

250 A/cm². Driving the LEDs harder produces more light from a smaller area. The spec sheets for Soraa's lamps claims that “Soraa's unique LED technology allows its lamps to operate effectively and efficiently at higher temperatures than other LED lamps, resulting in more light output per diode.”

Benefits: According to Brian Coppa of the all LED Lighting blog, GaN substrates exhibit 1,000 times fewer defects than sapphire. This significantly boosts light output and leads to better performance at higher currents and higher temperatures. Heat sinks can be simplified. So Soraa can generate more light with a single LED chip, reducing the number of chips in a fixture for a given luminosity. Also, Soraa is selling its LED products mainly in high-volume bulk orders, further reducing prices.

Market prospects: Soraa was able to leverage funding from the US Department of Energy (DOE), and now the company has been appointed by the DOE to lead the industry in this mission of developing a low-cost GaN substrate, since it is a leader in this technology.

Phosphor technology

There are several approaches to generate white light using LEDs. Three basic methods are described below.

Figure 3:
8 inch silicon wafers in a MOCVD reactor
(Credits: Bridgelux)

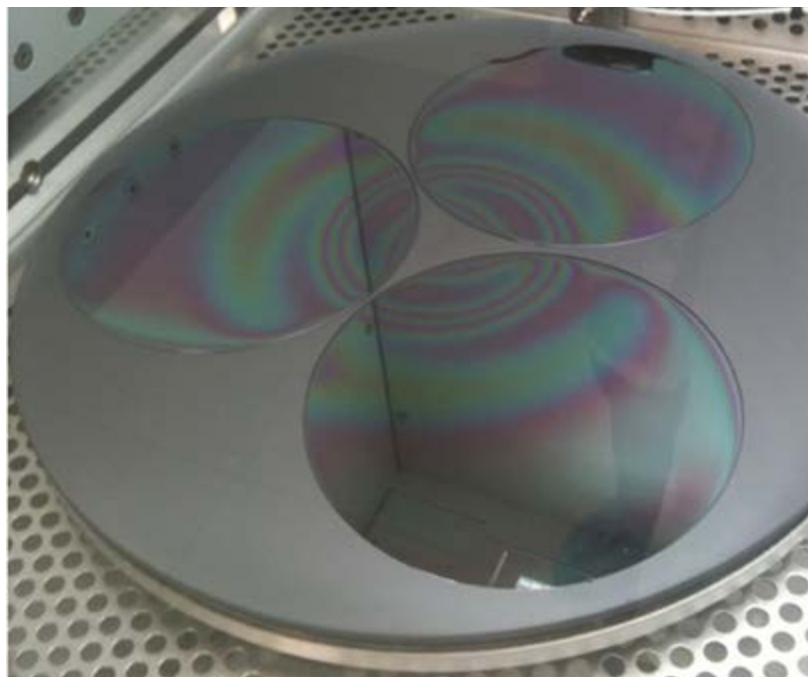
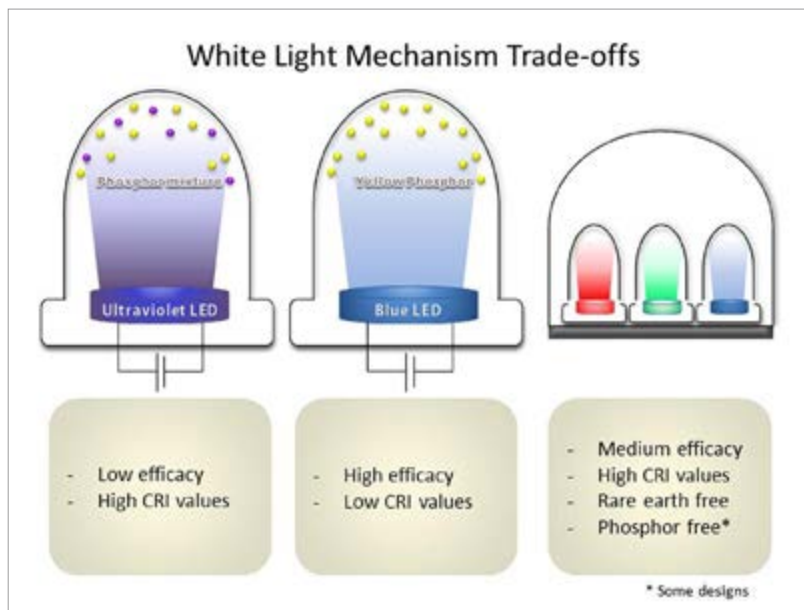

Figure 4:
Three basic approaches to generate white light with LEDs



Meanwhile there are several variations and also combinations of these approaches available.

State-of-the-Art: The first is to use ultraviolet/purple LEDs, which illuminate a red, green and blue phosphor. These phosphor materials convert the high energy UV light from the LED chip, down to lower energy wavelengths of red, green and blue light. The total light is combined to produce white light. The second option is to use a blue LED to illuminate a yellow phosphor. Actually, there were also products introduced that add red phosphor to the system to improve CRI. The third option is to use individual LEDs with red, green and blue colors, together in one bulb, to produce white light. More sophisticated solutions add an amber LED or white LED, and some even use up to eight LEDs of different color to provide higher CRI.

A fourth option, known as the “remote phosphor” method is now being pursued by a growing number of companies, since it is claimed it can improve white LED efficiency by 30-40% compared with existing ones by minimizing heat generation and light losses.

Initial situation: Leading LED phosphor firm Nichia as well as the main lighting firms including GE, Philips, and Osram as well as more specialized firms like

Toyoda Gosei and Intematix have invested R&D in this technology. In this case “remote” refers to the fact that the phosphor is not connected to or built into the LEDs. This is done for a number of design reasons, including the placement of the highly directional LEDs and to prevent multiple shadows from forming.

Market prospects: In terms of their market share today, these alternative technologies are less popular than phosphor illumination by LED chips. However, they are all potentially viable technologies in the solid state lighting roadmap. Eventually, the quality, reliability, and actual product price will be the principle differentiators between choosing one white light generation technology over another.

Low voltage AC LED

In most applications, LEDs are driven by a DC power supply, but AC offers several significant advantages. A relatively new approach is to develop AC LEDs, which can operate directly from an AC power supply. At the forefront of these developments are Lynk Labs, Seoul Semiconductor and III-N Technology. Bob Kottrisch of Lynk Labs claims that driverless LEDs provide several advantages.

Benefits: With AC, power is transmitted and used much more efficiently. Putting LEDs directly on the end

without having to include complex electronics to convert AC back into DC offers a double advantage. Power is handled efficiently in the distribution environment, and is delivered more effectively without intervening electronics.

State-of-the-Art: A technology developed by Seoul Semiconductor and separately by III-N Technology uses the Christmas tree approach at the die level. The AC LED device is actually made up of two strings of series-connected die, connected in different directions; one string is illuminated during the positive half of the AC cycle, the other during the negative half.

The strings are alternately energized and de-energized at the 50/60Hz frequency of the AC mains power source, and thus the LED always appears to be energized. The technology developed by Seoul and III-N specifically relates to LED devices designed for high-voltage 50/60 Hz mains AC power.

Lynk Labs, however, has developed and patented alternative AC-LED technology for both high and low-voltage AC. They use existing LEDs or dies with various designs. Some layouts were demonstrated by Bob Kottrisch from Lynk Labs at LpS 2012 and in his article in LpR 31-2012; for example bridged, hybrid and driverless rectified designs (Figure 5). The company claims to hold the broadest patent portfolio surrounding AC-LED devices, assemblies, drivers and systems. Also, Lynk Labs and Philips separately hold fundamental IP in driving LEDs with high frequency inverter type drivers.

Quantum Dot LEDs

Quantum dots are semiconductor nanocrystals made from the same materials as ordinary semiconductors (mainly combinations of transition materials and / or metalloids). Unlike ordinary bulk semiconductors, which are generally visible to the naked eye, quantum dots are incredibly small, from 2 to 10 nanometers (10-50 atoms)

Figure 5: Bob Kottritsch from Lynk Labs distinguishes between self-rectifying LED circuit topologies (simple anti-parallel and hybrid bridge structures) and externally (bridge) rectified - hVf LED circuits

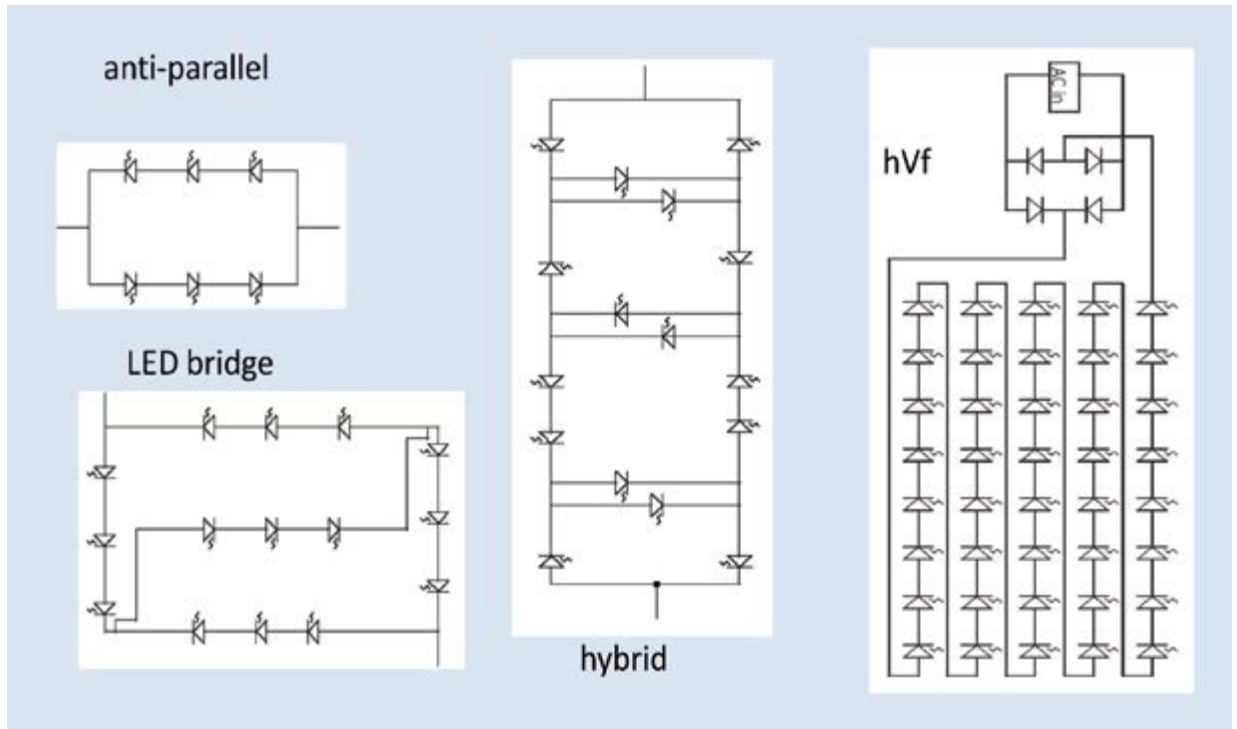

in diameter, this is so small in fact that they are considered as “nearly zero-dimensional”. These nanocrystals possess unique optical properties, whereby their emission color can be tuned from the visible throughout the infrared spectrum. This allows quantum dot LEDs to create almost any color.

Initial situation: Companies, such as QD vision and Nancoco are investigating the potential of combining quantum dots with LEDs as an alternative to phosphors to improve color rendition. Although exploratory technology at this stage, Quantum Dot LEDs (QLEDs) could be used in much the same way as LED phosphor coatings to offer improved color saturation, color tunability and color precision.

Market prospects: Quantum dots are also being considered for use in white light-emitting diodes in liquid crystal display (LCD) televisions. According to US Researchers Nanomarkets, Quantum dots, which can be precisely tuned to deliver only the needed / desired emission colors, may be the next “big thing” in solid state lighting and could pose a long-term threat to conventional phosphor technologies.

Evolving Form Factors

If we analyze the form factors adopted by the latest best in class LED luminaires in terms of lumen output, they are adopting very different shapes and sizes to conventional lighting sources to maximize the potential lumen output of LEDs so to achieve the best efficiencies, consumer expectations of what a lamp or luminaire actually looks like may need to evolve over time.

Initial situation: When considering the future of the lighting industry most people still think in terms of traditional form-factors such as the basic A-19 incandescent lamp. Many manufacturers are addressing this market with an evolutionary approach; incorporating LEDs into traditional lighting fixtures and replacement bulb form factors. Others are taking a more revolutionary approach and using the LED chip as an opportunity to rethink the lighting value proposition and leverage LEDs as highly controllable illumination sources that open up new types of applications.

State-of-the-Art: Due to their small size and directional light characteristics, LED light sources do not have to follow the same rules as competing

technologies. No inert gases are required to prevent combustion, and no mercury is required to generate light. This freedom creates new potential future designs of LED lighting.

Applications and Benefits: The bulb style LED fixtures on the market today may become free-form luminaires and bulb-less luminous wall coverings instead and there are increased possibilities for lighting mood management and colors. This could result in the development of new applications but also provides potential for highly innovative luminaire players to differentiate themselves from competitors through new designs and more sophisticated systems. The options for OLED based devices are even more extreme, as they can be made on extremely thin and flexible substrates, OLED based lighting could be incorporated into furniture or architectural designs.

Market prospects: Such changes are likely to occur first in the high-end retail and hospitality sectors initially as a form of differentiation for discerning clientele, but increasingly differentiated products may help firms to retain a strong market position.

Conclusions

The proposed key technologies are very heterogeneous and have very different preconditions. In fact, these technologies can be split up in at least two groups; basically one that contains established and one that contains emerging and immature technologies.

From a technical point of view, the first group of mature or almost mature technologies consists of phosphor technology and smart lighting. These technologies are well understood. The choice of the right solution for an application is relevant. While the phosphor technologies are the basics of white light generation, and the business success is directly related with the sales of white LED systems, it is different for smart lighting. Smart lighting is a feature on top of pure illumination. The technologies are available, but the costs were limiting a broad adoption until now. The possibilities in combination with LEDs and more cost effective new solutions could lead to an over-proportional growth of that business.

The five other technologies need to develop further to become a relevant fraction of the lighting market.

Both alternative substrate technologies are an approach to make LEDs more cost efficient. This may speed up the

adoption of LED lighting, but there are also other measures from manufacturers to reduce production costs. However, these technologies are boosting competition and therefore support cost reduction.

AC LEDs and driverless technology is already at a stage where it has its position in the market. The technology is constantly improving, but still has to deal with some flicker issues that are not acceptable for some applications. It may be unrealistic that this will become a one-for-all technology, but there are a number of applications where this technology can be applied and is already applied.

For some lighting applications, OLEDs would have advantages. However, they have efficiency, durability but mainly cost problems when compared with LEDs. Before they find their way into mass production, the price has to be dramatically reduced. Even then OLEDs may only be the first choice if required by an application when, for instance, a design requires a thin and bendable light source. OLEDs will have their application, but in many fields they have to compete with cost effective LED solutions directly.

Quantum dots have a very similar handicap to the one that OLEDs have. In the end they might prove to be the

better technology, but currently they are not at all competitive. While the competing technologies are also developing further, it is hard to say if QDs will be broadly adopted or only used for some niches.

Finally, evolving form factors is probably the most interesting proposal of the report. This point requires good expertise within the whole system. Traditional lighting manufacturers are used to dealing with standard light sources and are used to assembling standard components with a design that is limited to the housing. This is the big chance for newcomers that understand LED systems. They are re-defining the design quality of the housing as well as the light. Combining a good new design with an affordable price will certainly be a winning strategy.

None of the seven technologies approaches presented is a real game-changer. They all have their advantages and drawbacks. However, they could all be relevant for the success of a product and in turn, a company on the market. In the end a lighting company needs to be aware of them and needs to be able to deal with all of them. Once again it proves to be true that not the single technology or component is relevant, but the best combination for an application is what counts. ■

Acknowledgements:

LED professional wants to thank Jim and Allan P. McHale for providing the report and giving their permission to use parts of it for this article. Besides the technology aspects, the authors Jim and Allan P. McHale also analyzed drivers and barriers. To learn more about this and other memoori reports, please visit <http://www.memoori.com/research/>.

guangzhou international lighting exhibition

广州国际照明展览会

19th

**The most influential and comprehensive lighting
and LED event in Asia**

9 - 12 June 2014

China Import and Export Fair Complex
Guangzhou, China

www.light.messefrankfurt.com.cn



Contact
Messe Frankfurt (HK) Ltd.
Tel: +852 2238 9969
Fax: +852 2598 8771
light@china.messefrankfurt.com
www.light.messefrankfurt.com.cn



LED professional Review (LpR) - Annual Subscriptions

LpR Digital Magazine

- 6 issues
- pdf download
- high resolution pictures and graphs
- printable
- commercial use
- access to all previous issues
- Euro 78.80

LpR Printed Magazine

- 6 issues
- Euro 158.40

<http://www.led-professional.com/subscription>

Cover-page:

Artwork: Thomas Klobassa,
©LED professional 2013

Main Image: Arno Grabher-Meyer,
LED professional

Product: Itswell UV LEDs & COB LEDs



The emitted light from the surrounding UV LEDs excites the phosphors of the cool white and warm white COB LEDs at the Itswell booth at LpS 2013

Next LpR

Performance & Standards
Issue 41 - Jan/Feb 2014 -
Short Overview

Technology:

How SSL LEDs Become Top Performers

There are different levers to improve LED performance. The authors have a look into the device itself and explore the principal limitations of the different contributors to device efficacy. They will show how to balance driving current and chip size to define the right LED, and explain the impact on performance and system costs of LED packages for the intended lighting task. ■

Characterization:

Developments in Photometry of LEDs and OLEDs

SSL devices such as LEDs and OLEDs have rapidly developed and offer an incredible range of benefits and opportunities over traditional light sources for new lighting installations. But with these opportunities also come challenges. The International Commission on Illumination (CIE) has risen to these challenges and will soon be publishing an International Standard Test Method for photometry of LED Lamps, LED Luminaires and LED Modules. This article will look in detail at some of the issues relating to the photometry of SSL products and the work being done by the CIE solving these challenges. ■

Measurement:

Using Integrating Spheres Correctly to Measure LEDs

LEDs have opened up new dimensions of design freedom, allowing architects and designers to give free rein to their creativity. Light-emitting diodes permit manifold design solutions as a light source in illumination products. The article shows a suitable measuring method or comparing key technical data that is required in order to get the best out of the diversity of illumination products available. ■

Regulation:

Understanding New EU Regulation for Directional Light

The European Union has introduced new regulation for directional light which means that the conventional method for measuring lumen is no longer valid. A new method has to be used to measure the effective lumen value which requires luminous intensity distribution to be measured. New consideration also has to be taken when designing new directional lighting fixtures to ensure the highest efficiency. ■

subject to change

Imprint

LED professional Review (LpR), ISSN 1993-890X

Publishing Company

Luger Research e.U.

Institute for Innovation & Technology
Moosmahdstrasse 30
A 6850 Dornbirn, Austria / Europe
phone +43 5572 39 44 89
fax +43 5572 20 60 70
info@lugerresearch.com
www.lugerresearch.com

Publisher

Siegfried Luger +43 5572 39 44 89-70
s.luger@led-professional.com

Editor-in-Chief

Arno Grabher-Meyer +43 5572 39 44 89-18
a.g-m@led-professional.com

Int. Account Manager

Theresa Koenig +43 5572 39 44 89-20
theresa.koenig@led-professional.com

Marketing & Sales Manager

Katharina Fink +43 5572 39 44 89-43
katharina.fink@led-professional.com

Your Local Contacts

China, Hong-Kong

Iris Yuen +86 1380 27 01 367
irisyuen88@hotmail.com

Germany

Armin Wezel +49 30 526 891 92
armin@eurokom-media.de

Japan

Eiji Yoshikawa +81 3 6751 0090
scala@s3.dion.ne.jp

South Korea

Jung Won Suh +82 2 78 58 222
sinsegi-2@sinsegimedia.info

Switzerland

Monika B. Ailingner +41 41 850 44 24
m.ailingner@marcomedia.ch

Taiwan

Leon Chen +886 2 256 81 786-10
leon@jkmedia.com.tw

United Kingdom & France

Zena Coupé +44 1923 85 25 37
zena@expomedia.biz

US East

Karen C Smith-Kernc +1 717 397 7100
KarenKCS@aol.com

US West & Canada

Alan A. Kernc +1 717 397 7100
AlanKCS@aol.com

Copyrights - Luger Research e.U.

The editors make every reasonable effort to verify the information published, but Luger Research e.U. assumes no responsibility for the validity of any manufacturers, non profit organisations or individuals claims or statements.

Luger Research e.U. does not assume and hereby disclaims any liability to any person for any loss or damage caused by errors or omissions in the material contained herein, regardless of whether such errors result from negligence, accident or any other cause whatsoever. You may not copy, reproduce, republish, download, post, broadcast, transmit, make available to the public, or otherwise use LED professional Review (LpR) content without prior written consent from Luger Research e.U. - Institute for Innovation & Technology, Austria. ■



MORE THAN
21,500
READERS

The leading worldwide authority for
LED & OLED lighting technology information.

LEDs • OLEDs • Light Engines • Lighting Modules • Optics • Drivers • Thermal Management • Lamps • Fixtures • Production & Measurement Equipment
Project Reports • Patent Reports • Research Reports • Event Reports

LED
professional

www.led-professional.com
www.led-professional-symposium.com

powered by Luger Research e.U.

Transforming Solid-State Lighting—Five Years Out

Where ever you are in the design process, we can help you access the world's leading SSL technology, select and source the best materials, design and engineer for speed to market produce the modules you need, and manage your supply chain.

Our engineers, designers, and innovators are working to help make the world of Five Years Out brighter than ever before.

Are you Five Years Out?

Then you're probably working with us.

Featured Suppliers

AVAGO
TECHNOLOGIES

molex

CREE

OSRAM
Opto Semiconductors

LINEAR
TECHNOLOGY

TE Authorized Distributor
connectivity

RECOM

NXP

LEDIL

Infineon

