



International Year of Light 2015 - Opening
DC Supply Grids for LED Lighting
Phase Cut Dimming
Tech-Talks BREGENZ: Ewing Liu

Special: EnLight
Project Outcomes

We create light because
it allows us to see the beauty
most often overlooked.
See more.

For years, we've been the world's leading creator of light engine technology. Innovation, quality, and reliability drive everything we do. Today, we're proud to reintroduce ourselves as a uniquely focused company, dedicated to shaping the future of light and helping our customers illuminate the world.

lumileds.com





EnLight Outcomes

EnLight stands for “Energy efficient & intelligent lighting systems” and was an EU funded and Philips Lighting coordinated project which ran from 2011 to 2014. The consortium consisted of 27 leading European companies and academic institutions from across the entire lighting value chain.

Now, for the first time, the EnLight consortium is publishing the main technical outcomes exclusively in this issue of LED professional Review. This EnLight compendium is comprised of six articles that total 38 pages. They consist of a project overview, a description of the system architectures, definitions of new form factors and light effects, the building blocks for intelligent luminaires, highlighting of peripheral devices and the new granular lighting controls from Philips Lighting, AME, University of Erlangen, Insta Elektro, PKCE, Infineon, Fraunhofer IZM, Philips Research, Legrand, Eagle Vision Systems, Fraunhofer IIS/EAS, CEA Leti and Osram.

The project had three technical objectives namely the optimization of LED lighting modules, the design of future non-conventional luminaires and the use of new and intelligent lighting systems. As a result the energy savings in office applications could be shown at 44% compared to LED retrofit and standard controlled lighting systems. The energy savings in hospitality could nearly be doubled and ended up at a figure of 81% energy reduction by using new luminary designs with intelligent controls.

This research is fundamental because the complete value chain on all different system levels was taken into consideration. Congratulations go out to Frank von Tuijl from Philips Lighting and the whole consortium team for this highly relevant work and the fantastic collaboration.

Besides the EnLight project results, you'll also want to read the report about the International Year of Light Opening Ceremony in Paris, Phase Cut Dimming techniques, DC Current Grids, Lighting for Horticulture, the Tech-Talk BREGENZ with Everlight, one of the Top 10 LED manufacturers and the commentary from Samsung about Human Centric Lighting.

Have a great read.

Yours Sincerely,

Siegfried Luger
CEO, Luger Research e.U.
Publisher, LED professional
Event Director, LpS 2015

COMMENTARY

- 06 LED Innovation Will Offer a Human-Centric Smart Lighting Platform
Enabling Enterprise IoT
by Frank Harder, Samsung

EVENTS

- 32 Let there be Light - A Brief Overview of the Meaning of Light
by Arno Grabher-Meyer, LED professional

TECH-TALKS BREGENZ

- 42 Ewing Liu, Technical Marketing Manager at Everlight
compiled by Dr. A. Prasad, LED professional

RESEARCH

- 48 Direct Current (DC) Supply Grids for LED Lighting
by Prof. Eberhard Waffenschmidt, Cologne University of Applied Science

TECHNOLOGIES

- 54 Solving the Phase-Cut Dimming Challenge
by Craig Sharp & Bill Trzyna, CCI Power Supplies LLC

SPECIAL

- 60 LED Lighting for Horticulture
by Ian Ashdown, Lighting Analysts

SPECIAL: ENLIGHT PROJECT OUTCOMES

- 68 EnLight - Next Generation Intelligent and Energy Efficient Lighting Systems
by Frank van Tuijl
- 72 System Architecture for Distributed Intelligence
by Lex James et al.
- 80 New Form Factor Luminaires and New Light Effects
by Herbert Weiß et al.
- 86 The Building Blocks for Intelligent Future Luminaires
by Tim Böttcher et al.
- 92 Peripheral Devices for the Right Light
by Werner Weber et al.
- 98 Granular Lighting Control Enables Significant Energy Savings
with Optimized User Comfort
by Eveliina Juntunen et al.

REGULARS

- 03 EDITORIAL
- 08 PRODUCT NEWS
- 26 RESEARCH NEWS
- 30 IYL 2015 NEWS
- 106 ABOUT | IMPRINT

IYL 2015

- 32 Let there be Light - A Brief Overview of the Meaning of Light
by Arno Grabher-Meyer, LED professional



SPECIAL: ENLIGHT

- 66 Project Outcomes
Written by various project partners



ADVERTISING INDEX

| | | | | | |
|---------------------|----|------------------------------|----|------------------------------------|-----|
| LUMILEDS | 2 | INSTRUMENT SYSTEMS | 22 | CREE | 31 |
| LEDFRIEND | 5 | GLOBAL LIGHTING TECHNOLOGIES | 23 | UNDERWRITERS LABORATORIES | 45 |
| INSTRUMENT SYSTEMS | 7 | FUHUA | 24 | LED EXPO THAILAND | 47 |
| LEDLINK | 9 | DANGOO ELECTRONICS | 25 | LED CHINA | 53 |
| ELLSWORTH ADHESIVES | 11 | INFINEON | 26 | GUANGZHOU INT. LIGHTING EXHIBITION | 57 |
| VOSSLÖH-SCHWABE | 11 | EDISON | 27 | LED & OLED EXPO | 59 |
| BICOM | 13 | WEBINAR: LAMBDA RESEARCH | 28 | LIGHTFAIR INTERNATIONAL | 65 |
| GL OPTIC | 15 | WEBINAR: INFINEON | 28 | LED PROFESSIONAL / LPS | 105 |
| HONGLITRONIC | 15 | PARAGON | 29 | ILLUMINOTRONICA | 107 |
| EPISTAR | 17 | BICOM | 29 | WAGO | 108 |
| REFOND | 19 | CREE | 29 | | |
| LEXTAR | 21 | LED LIGHTING TAIWAN | 29 | | |



Professional supplier of
LED drivers & power supplies

Regional Sales Agent Wanted!

To light up one third of the world

Low-Profile Aluminum Casing LED Drivers

- 1.LIFUD low-profile (21 x 30mm) aluminum casing. Output power 20W-70W.
- 2.AC100-277V for global market application.
- 3.ENEC, CE, RCM, UL, FCC, PSE, CCC certifications.
- 4.Common type, flicker-free type, 1-10V dimmable versions all available.
- 5.Lifetime 25,000 hours under temperature of 50°C, the life time doubles when the temperature is dropped by each 10°C.
- 6.Compatible with class 1 and class 2 LED lights application.
- 7.Designed for LED lights application such as tri-proof lights, tube lights, grid lights and etc.

High Performance-Price-Ratio LED Drivers

- 1.Economic design, high performance but economical cost.
- 2.Output power 10W-50W.
- 3.AC200-240V input, specifically designed for European, Australian and China markets.
- 4.CE, CB, TUV, SAA certifications.
- 5.Plastic covers, both screw terminal blocks (IP20) and female and male connector cable version (IP60) are available.
- 6.Low harmonics (THD < 10% for samples and < 15% for mass production).
- 7.Lifetime 25,000 hours and 50,000 hours version under temperature of 40°C are both available.
- 8.Applied for LED down lights, ceiling lights and panel lights, and etc.



Shenzhen Ledfriend Optoelectronics Co.,Ltd (Headquarter)

TEL:+86 755 23420300

FAX:+86 755 83739228

sales@ledfriend.com

www.lifud.com

Building B, Jiahua Industrial Park, Xinpotou Village, Guangming New District, Shenzhen CN-518107, China.

Sichuan Ledfriend Technology Co.,Ltd (Production Base)

Add.:Shigao Economic Development Zone, CN-620564 Renshou County, Sichuan Province, China.



Frank Harder

Frank Harder is the Vice President of Business Development at the Samsung Strategy and Innovation Center in Menlo Park, California. He holds an M.S. degree in Electrical Engineering from the University of Düsseldorf and graduated from the Octagon Leadership program at the Wharton University of Philadelphia.

LED INNOVATION WILL OFFER A HUMAN-CENTRIC SMART LIGHTING PLATFORM ENABLING ENTERPRISE IOT

After a century of analog electrical light, the lighting industry has spent the last decade in transition to digital light sources; LEDs, sought to replace the tungsten filament. LEDs are now embedded in all market segments in both residential and commercial applications. The predictions of early LED pioneers such as Dr. Roland Haitz have become reality today: more lumens delivered at a lower cost with increasing reliability and quality of light attributes. As a result, the world of electrical light has accepted that LEDs will be its primary light source and contribute to saving significant electrical energy, reducing carbon emissions and providing increased safety and comfort in our homes, at work and even while commuting in traffic.

Today, we are on a fast track to the commoditization of light sources using LEDs. What we have yet to realize is that this change offers an enormous opportunity. The so-called digital lighting revolution is about to take place and early efforts in the market are already showing promise. Technology evangelists, the hi-tech start-up world and large technology firms equally are evaluating the opportunities at the intersection of the digital light sources and the internet of things (IoT). Market and technical requirements are in flux without standards and the direction is still not clear. How exactly will the market for intelligent lighting evolve and how quickly will it become commonplace?

At conferences around the world such as the LED professional Symposium and LightFair International, there are many presentations that focus on how IoT will advance intelligent applications such as human-centric lighting in combination with connectivity, sensors and data. A human-centric smart lighting system will require broad awareness with a deep level of systems understanding in order to

provide the environmental and situational criteria that enable decision-making from a valuable smart lighting system. Algorithms and analytics will be the key differentiator to leverage data that are generated from sensors.

The goal is a seamless link between LEDs and selected use cases through secure and scalable connectivity of all established wireless and wired standards, the fusion with sensors (internal and external), processing power, memory and application programmable interfaces (APIs). Such innovation will be enhanced by a state machine embedded in the core of a new platform. It will offer both the lighting OEM community as well as the application developer community the option to customize services tailored around end-user needs, ultimately to develop additional value and business opportunities far beyond energy savings to their customers.

We believe that the realization of smart lighting will require a new and holistic platform approach and an ecosystem of sensor providers, analytics specialists and app developers. No longer can we think of a light source that is connected to other things, we must instead think about a connected platform that, among other things, also delivers light. In the near future, appliances that deliver light will also connect to the HVAC, printers, the security system and other building and city functions. Companies like Samsung Electronics are addressing this thesis by developing a smart lighting platform through close collaboration with sensor, analytics and lighting partners as well as leveraging a wide range of divisions that operate in different markets. It is a holistic approach to an opportunity that will ultimately deliver a true smart platform that forever changes the way we think about light. ■

F.H.

We bring quality to light.



DISCOVERING
LIGHT

Putting LEDs in the right light.

SSL solutions from the world leader in LED measurement



LGS 1000
Goniophotometer
with new features

Right from the start, we have been supporting the LED industries with our measurement equipment. You will also benefit from this expertise in the new Solid-State Lighting applications. Our solutions combine highly precise spectroradiometers and photometers with a complete family of goniometers and integrating spheres. Discover light with Instrument Systems.

www.instrumentsystems.com/ssl

 **Instrument
Systems**
light measurement

Flip Chip Opto Introduces 300, 600 & 960 W CoB LEDs

Flip Chip Opto, a LED lighting technology company, announced its innovative P-Series of high-power LED Flip Chip / Chip-on-Board (COB) products. These high-performance lighting modules are comprised of patented 3-Pad LED flip chips with a Pillar Metal Core Printed Circuit Board (P-MCPCB) to substantially reduce module thermal resistance, and results in lower junction temperature, lower thermal decay and the feasibility of smaller light emitting surfaces (LES). Our innovation enables designers to enhance “Lumen-per-Dollar” performance by either driving the modules at higher currents for more light output, or shrinking the heatsinks and optics dimensions, or reducing LED chip counts.



Flip Chip Opto's 300, 600 and 960 W CoB LED modules are based on their patented 3-Pad LED Flip Chips with Pillar Metal Core PCBs

The High Power P-Series COBs feature 45x45 mils 3-Pad LED flip chips and high flux density in small LES. The current models, P110-12S8P (96 chips), P110-15S12P (180 chips) and P110-15S19P (285 chips) support “Boost” power at 300 W, 600 W and 960 W with LES of 45 mm, 60 mm and 85 mm, respectively. Their high “lumen-per-dollar” value and extremely low thermal resistance (0.01°C/W, 0.008°C/W and 0.007°C/W) make these COB solutions ideal to replace HID luminaires applied over stadium, sport complex, wharf, storage, airport, golf course, farmland and architectural display. ■

Cree Updates CXA Platform with SC5 Technology

Cree, Inc. introduces a new addition to its industry leading CXA LED array family, CXA2 LED arrays, delivering up to 33% higher efficacy in the same form factors.

Utilizing elements of the Cree SC5 Technology™ Platform, this improvement in lumen density enables better performance and radically reduces system size and cost. The new chip-on-board (CoB) LEDs allow lighting manufacturers to rapidly deliver more innovative solutions for applications such as track, downlight and outdoor lighting.



Cree's CXA2 now incorporates SC5 technology to boost performance and reliability to a new level

“We are working together with Cree to evaluate their latest CoB technology,” said Massimo Parravicini, R&D director of Reggiani Illuminazione. “I believe that the new CXA2 LED arrays, which deliver excellent performance in such small LES [light emitting surface], would be a great solution for the new generation of indoor luminaires we are currently developing.”

With the new CXA2 LED arrays, lighting manufacturers can achieve the same or better performance with a smaller LES compared to earlier products. For example, a 3800 lumen output from a larger 19 mm LES LED can be replaced with a smaller 12 mm LES LED, resulting in up to 60% system cost savings from lower LED, mechanical and optic material costs.

“The new CXA2 LED arrays make it possible for lighting designers to radically reduce system costs in the next generation of industry-leading lighting products,” said Dave Emerson, vice president and general manager for Cree LEDs. “By giving our customers innovative LED solutions instead of incremental LED improvements, we enable them to differentiate their products in the marketplace and deliver more value to their end customers.”

CXA2 LED arrays share the same physical design as earlier arrays, allowing lighting manufacturers to leverage the existing optical, mechanical and electrical design elements to accelerate time to market without additional cost. LM-80 data is

available for all CXA2 LED arrays for lighting manufacturers seeking Energy Star® qualification. The CXA2 LED arrays are also UL®-recognized components and feature a level 4 rating.

Through improvements in the light conversion process, Cree has reduced LED-to-LED color variations and, among other options, offers CXA2 LED arrays in 2-step and 3-step EasyWhite® bins. XLamp® CXA2 LED arrays are available in 2700 K to 6500 K, CRI options of 70, 80 and 90 with multiple voltage options in LES ranging from 6-30 mm with a lumen range of 250-19,000 lumens to address a wide variety of applications. Product samples are available now, and production quantities are available with standard lead times. ■

Osram Opto Updates Duris E 3 for Cost-Effective Linear Tubes

Osram Opto Semiconductors is presenting a new version of the well-established Duris product family: the Duris E 3 (GW JCLMS1. EC). Featuring a new leadframe material, the LED offers a longer lifetime and greater performance reliability than its predecessors. In linear tube lighting applications, the new Duris E version boasts a high efficacy of typically 135 lm/W at 4000 K and 65 mA as well as one of the best lumen/cost ratios in the series.



Osram Opto's new Duris E 3 offers compact size and excellent price-performance ratio

Technical Data:

- Footprint: 3.0 mm x 1.4 mm
- Typical flux (at 65 mA, 4000 K): 27 lm
- Viewing angle: 110°
- Efficacy: typ. 135 lm/W at 4000 K
- Color rendering (CRI): min. 80



Ledlink Optics, Inc.

▶ New Products

▽ Silicone street lighting

Type I



LL01CR-BZT80140L83-Mx

LxWxH(mm) 67x35x17.2
FWHM 80°x140°
Cree CXA15xx

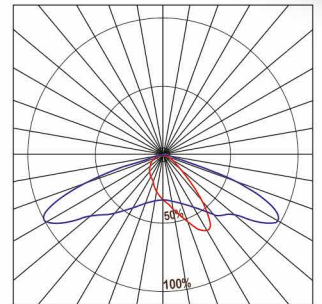

▽ Wall washer



LL01CR-CAX1090L06
LxWxH(mm) 20.5x20.5x13.9
FWHM 10°x90°
Cree XP-E2/ XPG2/ XPL
Nichia NVS19B/ NCS19B
LGIInnotek H35C1
Osram Oslon Square



LL01CR-CAX2590L06
LxWxH(mm) 20.5x20.5x13.9
FWHM 25°x90°
Cree XP-E2/ XPG2/ XPL
Nichia NVS19B/ NCS19B/ 757D
LGIInnotek H35C1
Osram Oslon Square

▽ Multi lens

4in1



LL04CR-CECxxL06

LxWxH(mm) 50x50x8.5
FWHM 25° 50°
Cree XPE2/ XPG2/ XPL
Nichia NVS19B/ NCS19B
Osram Oslon Square
Lumileds Luxeon T



Our Services



▶ R & D ▶ Precision Mould ▶ Manufacture
▶ Component solution ▶ Customerization

Further technical information is available, please contact us for more details.

| www.ledlink-optics.com | service@ledlink-optics.com



The package of the new Duris E 3 is made from a special PCT leadframe material that permits a longer lifetime and higher performance reliability than the PPA material used in the current Duris E 3 version (LxW JNSH.EC). As a result, it achieves the best brightness level per dollar (lm/\$) within the Duris E series. Furthermore, the new LED has a high efficacy of typically 135 lm/W at 4000 K. The new Duris E 3 offers a range of lumen packages from 25 lumens (lm) to 30 lm, which can optimally be used in linear tube light applications. Integrated in these lighting solutions, the number of LEDs can be minimized and the so-called hot-spot effect can be avoided. The Duris E 3's thermal resistance is typ. 41 K/W.

With a beam angle of 110°, the Duris E 3 is ideal for homogenous and uniform light distribution. Another advantage is the small footprint of 3.0 mm x 1.4 mm, a competitive value by industry standards. With its excellent color uniformity, stability and a good color rendering of min. 80, the new LED is particularly suitable for interior lighting applications like linear, troffer or panel lights, retrofits - especially fluorescent replacement lamps - downlights and fixtures. ■

Toshiba's Improved White GaN-on-Si LEDs with up to 160 lpw

Toshiba has launched a new series of high power LEDs ideal for use in a wide variety of residential, commercial and industrial lighting applications. The TL1L4 series offers significantly better performance than the preceding TL1L3 series.

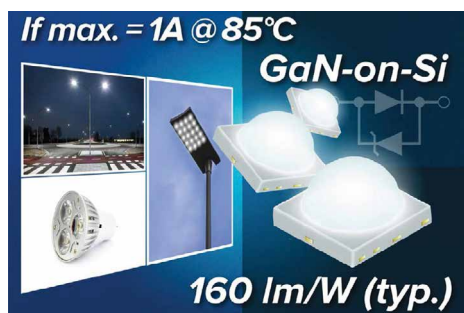

Toshiba's latest GaN-on-Si TL1L4 series LEDs are capable of being driven with up to 1 A

The new TL1L4 series achieves an industry leading high luminous efficacy that surpasses 160 lm/W at room temperature operation. Under conditions of $T_a = 85^\circ\text{C}$, operating current can be driven to 1 A and

luminous flux is more than 60% greater than that offered by the preceding TL1L3 series. This contributes to improved luminous efficacy and lower power consumption for LED applications.

Available in nine-color variations from 2700 K to 6500 K, the TL1L4 series utilizes cost-effective gallium nitride-on-silicon (GaN-on-Si) wafer technology to create LEDs optimized for both output and energy efficiency.

The devices are housed in a compact 3.5 x 3.5 mm lens and rated to support an absolute maximum forward current of 1.5 A max at $T_a < 55^\circ\text{C}$ and $T_j < 150^\circ\text{C}$. Hot binning tests for electrical and optical characteristics are conducted at 85°C and $I_f = 350\text{ mA}$ that simulate real-life operating conditions. ■

New Duris S 8 LEDs with Even Better Color Rendering & Consistency

Osram Opto Semiconductors presents two new members of its Duris LED family with a very good color rendering. The CRI of the Duris S 8 GW P9LM32.CM and GW P9LR31.CM is at 95 (typ.) respectively 90 (min.). Due to the same footprint and design the different versions can be replaced easily. The thermal resistance and the forward voltage of the new products are lower than its predecessors. The LEDs are binned at 100°C , so their brightness and color values can accurately be determined with regard to their later use.



The new Duris S 8 not only features high color consistency for directional retrofits, downlights and spots, but also the highest CRI of up to 95

The new Duris S 8 with CRI 90 is the next step in the Duris S series regarding increasingly better color rendering. The very good color consistency (color binning) is achieved through the close grouping of the multi-chip LEDs, which corresponds to the

coverage of a 5-step MacAdam ellipse. 3-step MacAdam grouping is additionally available. As its predecessors, the products are grouped at the junction temperature of 100°C instead of at room temperature. Another positive characteristic is the improved thermal conductivity.

The footprint (5.89 mm x 5.2 mm) of the new high-power LEDs exactly corresponds to the existing Duris S 8 versions as well as the viewing angle of 120° . The optics are also compatible to the predecessors so the different versions can be replaced easily. The correlated color temperatures (CCTs) can be chosen between 2,700 and 4,000 K. With the new Duris LEDs single light source design can be implemented. This avoids multiple shadow effects and simplifies lens and PCB (printed circuit board) design.

The new Duris S 8 can be inserted in retrofits and fixtures for accent and effect lighting in shops and museums. The certification process for the high lifetime standard of LM-80 with 6,000 hour tests for both new LEDs is done and the results are already available. ■

Osram Opto Offers "Far Red" LED for Horticultural Lighting

Osram Opto Semiconductors is expanding its LED product range for horticultural lighting with a new type of the well-proven Oslon SSL. In addition to the existing hyper red (660 nm) and deep blue (450 nm) versions, the high-tech company developed a far red Oslon SSL LED with a wavelength of 730 nm.

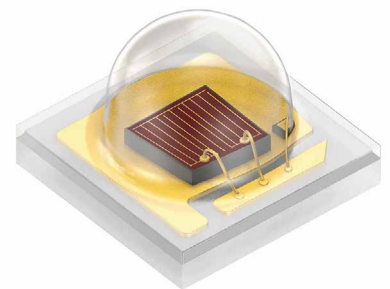

The far red Oslon SSL LED with a wavelength of 730 nanometers leads to better growth for certain plants such as tomatoes, pepper or roses

For certain plants such as tomatoes, pepper or roses, it is exactly this wavelength which leads to better growth. Customers now have a better coverage of the color spectrum.

From Lighting to Electronics...

ELLSWORTH
ADHESIVES

Specialty Chemicals for Your Complete Lighting Assembly

Adhesives | Sealants | Potting Material | Thermal Management



Ask the Glue Doctor®

1.800.888.0698
ellsworth.com

Products from



The new ultra compact Oslon SSL will be available in two new product versions with a narrow beam angle of 80° and 150°. Because of these features, the LEDs can be arranged close to one another and offer a uniform light impression. All Oslon SSL versions can be combined easily because of the same size of footprint and solder pad and because they feature the same technical characteristics. This offers high design flexibility for ambitious horticultural lighting applications, where each greenhouse lighting system needs a tailor-made solution.

LED lighting can stimulate plant growth by up to 40%. Different wavelengths address different plant properties: blue light supports flowers to open up and red light helps stems to grow better. Thus, a combination of the three existing versions of the

Oslon SSL LED family (far red (730 nm), hyper red (660 nm) and deep blue (450 nm)) provides an optimal growth pattern. With this range of three colors, the customers can address a large variety of plants.

There are several general benefits of LEDs for use in horticultural lighting: Because of the single LEDs, the lighting can easily be steered and controlled in the greenhouses. LEDs have a longer lifetime than other lighting technologies; they are very energy-efficient and thus drastically reduce energy consumption over time.

They also emit no heat in the lighting direction, so the plants will not be damaged. Furthermore LEDs are available in different wavelengths and lighting solutions can be exactly adjusted to the value the respective plant needs. ■

LIGHTING SOLUTIONS

LUGA Shop Pearl White

Impress your customers with the unique light quality of LUGA Shop Pearl White, the new star on the fashion horizon and the future of shop lighting.



Brilliant Colours
High CRI
L90/B10 | > 143 lm/W

www.vossloh-schwabe.com

Bridgelux's New LED Arrays with 130+ lm/W Warm White Efficacy

Bridgelux, a leading developer and manufacturer of LED lighting technologies, is now shipping its Vero® and V Series™ LED array products with high performing warm white efficacy of 130 lumens per watt (lm/W) and greater. This enhanced performance delivers up to 10% additional energy savings over previous generations. Furthermore, the company has achieved a record warm white efficacy of greater than 160 lm/W on its existing chip on board platforms. With these efficacy gains, Bridgelux continues its tradition of breakthrough LED chip and packaging technology innovation and helps further accelerate the adoption of solid-state lighting.



Bridgelux's latest generation of Vero® and V Series™ LED array products exceed 130lm/W efficacy

LED arrays with an efficacy of 130lm/W not only provide a significant return on investment to end customers, but also help OEMs and manufacturers better compete with product offerings in state of the art LED based products. The featured 130 lm/W efficacy is now a standard across all Bridgelux Vero and V Series product form factors (3000K, 80 CRI nominal current). Bridgelux Vero arrays provide designers with a best-in-class light source design, a wide range of premium color options, easy integration and installation, reduced manufacturing costs and the industry's best product warranty for LED light source products. Bridgelux V Series arrays leverage the technology and performance of the Vero products in smaller, cost effective packages.

"Our team is committed to programs that improve LED package efficiencies, while maintaining the dazzling high-level

of Bridgelux color and uniformity that our customers have come to rely upon," said Aaron Merrill, Director of Product Marketing at Bridgelux. "With advancements in phosphor and die technology we're already achieving efficacies on our current platform that position Bridgelux to push our efficacy leadership well into the future."

With a strong focus on R&D advancing emerging technologies, Bridgelux is a leading innovator in the ever-expanding market for LED lighting solutions. The company is dedicated to the efficient delivery of differentiated, high performance and cost-effective light source solutions that delight the public with aesthetically pleasing, energy saving LED lighting. ■

Osram Opto Adds High CRI Duris E5 for High Quality Applications

Osram Opto Semiconductors presents a new Duris E5 with a significantly improved efficacy of more than 130 lm/W compared to the current version. A high color rendering index (CRI) of more than 90 and typically 95 enables high quality lighting solutions in shops or museums. Due to the same footprint and other common features the new mid-power LED can replace the current product versions very easily.



With a high CRI and high efficiency, the new Duris E5 is the ideal choice for cost effective, high quality general lighting products

The new Duris E5 (GW JDSRS1.CC) will complement the well-known Duris product family of Osram Opto Semiconductors by mid of January 2015. With an improved efficacy of 131 lm/W at 4000 K and 120 mA it can be used perfectly for energy saving lighting applications. Furthermore, the new mid-power LED features an improved

thermal conductivity as well as lower forward voltage (3 V at 120 mA). The optics are absolutely compatible to all members of the Duris family and the platform design is the same, so customers can replace the current LED versions easily.

The typically good color rendering of 95 makes the new Duris E5 ideal for applications in which the requirements for good quality of light are particularly high, e.g. professional lighting solutions in shops or museums, but they can also be used for non-directional indoor LED retrofits. The well-known package offers great design flexibility for the customers and facilitates the replacement of previous product versions, too.

Cree Expands SC5 Technology Platform with New XLamp MHD

Building on the success of the XLamp® MH family of LEDs, Cree introduces the XLamp MHD-E and MHD-G LEDs, the high-power LEDs that combine the high lumen density and reliability of a ceramic chip-on-board LED with the design and manufacturing advantages of a surface-mount package. Utilizing elements of the Cree SC5 Technology™ Platform, the ceramic XLamp MHD LEDs simplify development, increase design flexibility and improve manufacturing efficiency compared to mid-power LEDs. The MH family enables new designs and significantly lower system costs, all while delivering industry-leading performance.



Cree's latest extension of the SC5 platform technology, the XLamp MHD series, is ideal for semi-directional, high-lumen applications

Cree XLamp MH LEDs "The high lumen output and high reliability of Cree's new MHD-G LED allows us to develop a new downlight that outperforms other downlights in the market," said Baly Luo, general manager,



LED Tube Cover

BICOM

Professional LED Lenses & Reflectors Manufacturer

- Develop over 100 new products monthly
- Cooperate closely with Osram, Philips, Cree, Nichia etc.
- Have rich industry experience in optics design and manufacture
- Finish a new optical design within 3 days& Trial-mould samples in 5 days
- Provide high efficiency LED Lenses, Reflectors, Tube& Bulb Covers

Single Lens



Reflector



LED Bulb Cover

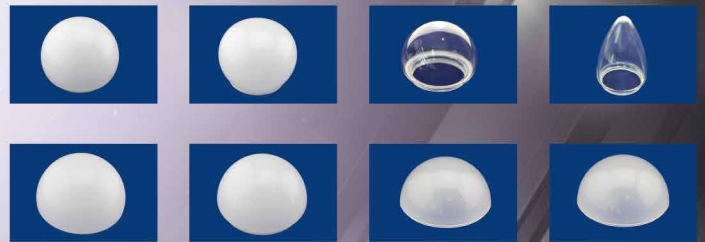

Streetlight Lens

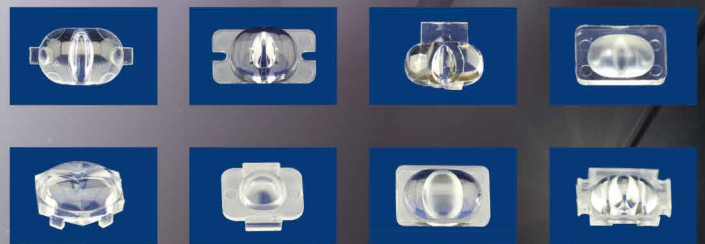

www.bicomoptics.com

SHENZHEN, CHINA

TEL: +86-755-29199996

FAX: +86-755-82033711

HONGKONG

TEL: +852-39216016

FAX: +852-27837978

SHANGHAI

TEL: +86-21-33634169

FAX: +86-21-33634512



ADD: B4 BUILDING, XINJIANXING INDUSTRIAL PARK, FENGXIN ROAD, GUANGMING DISTRICT, SHENZHEN

Email: sales@bicomoptics.com

Aeon Lighting Technology. “ALT’s compact-size, 4-inch downlight that is built with the MHD-G LED generates over 1800 lumens at 3000 K while other downlights can only produce 800 to 1000 lumens.”

Featuring Cree EasyWhite® technology in a 7 mm x 7 mm package, XLamp MH LEDs enable a smaller board size, tighter beam angle and a more traditional appearance than mid-power LEDs. Delivering more than 1800 lumens at 14 W and 2500 lumens at 19 W respectively, the XLamp MHD-E and MHD-G LEDs are ideal for semi-directional, high-lumen applications such as downlights, high-bay and outdoor area applications.

“At Cree, we continue to deliver innovative products that give our customers a competitive edge in the marketplace,” said Paul Thielen, Cree director of marketing, LED Components. “With the MHD LEDs, we’re offering chip-on-board performance to lighting manufacturers that prefer surface-mount technology, making it easier for them to achieve lower system cost than with the same commoditized mid-power LEDs that everyone is using.” ■

LG Chem Announces Two OLED Lighting Product Milestones

LG Chem announced that it achieved two important milestones in the development of OLED lighting products with the start of mass production of the 320 x 320 mm OLED light panel, the world’s largest available in the market, and the completion of the research and development phase for a new plastic-based flexible OLED light panel.

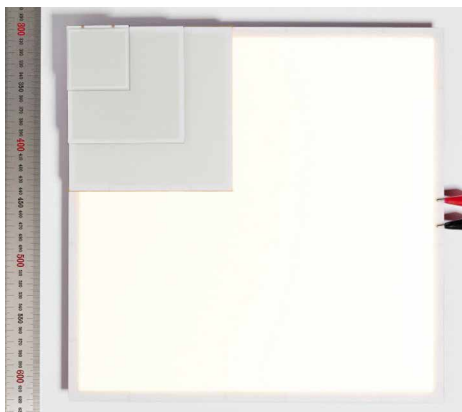

Area size comparison of LG Chem’s new 320x320 mm OLED to conventional standard sized OLED panels

The 320x320 mm OLED light panel is a 0.88 mm thick panel and has an efficiency of 60 lm/W, CRI over 90, and has output levels of 800 lm with a nominal input (8.5 V 1.6 A). The panel’s output can reach 1,200 lm which is similar to a common 60-75 Watt incandescent lamp. This is significant because it marks the first time that OLEDs can be considered as an energy-efficient / human-friendly light source available for general purpose use.

With LG Chem having begun mass-producing the 320x320 mm panels in January, the panels can be ordered at US \$680 per panel, with a lower negotiated price for bulk orders.

LG Chem has also completed development of a truly flexible plastic-based OLED light panel and engineering samples are now available. LG Chem’s current bendable OLED panels (F6BA40, F6BA30) are thin-glass based that provides a limited bending radius of 75 mm. The new flexible OLED panel has vastly increased the bending radius flexibility to 30 mm because of the adoption of a plastic substrate for the panel, which also eliminates the danger of the panel shattering when excessive force is applied.

The main challenge of converting from a glass substrate to plastic was to maintain the performance levels of efficiency, luminance, and CRI. LG Chem has overcome this challenge by adopting its expertise in barrier and encapsulation technology.

The specifications of LG Chem’s new plastic-based OLED light panel are 60 lm/W efficiency, 75 lm brightness, 3,000 K in color temperature, and CRI over 85. Engineering samples are available at US \$250 per panel. Mass production of the flexible panel is scheduled to begin in July 2015. The price will be adjusted accordingly once mass production starts. ■

Soraa Enters LED Light Engine Business with “Optical Light Engines”

Soraa, the world leader in GaN-on-GaN™ LED technology, launched a small, low profile series of light engines that provide fixture manufacturers access to the company’s full visible spectrum GaN-on-GaN LED technology. From narrow spot to flood,



Soraa’s Optical Light Engines provide fixture manufacturers access to the company’s full visible spectrum GaN-on-GaN LED technology

Soraa’s Optical Light Engines produce incredibly high CBCP; and the engine’s optical design provides flawless beam definition, smooth beam edges and is customizable with the company’s SNAP System. Designed for seamless fixture integration, the Optical Light Engines are compatible with a wide variety of industry-standard LED drivers and perfect for use in enclosed, non-ventilated indoor and outdoor fixtures.

“Fixture manufacturers have been asking for a compact, powerful, high-quality light engine and our full visible spectrum GaN-on-GaN LED technology has delivered. With Soraa’s signature Point Source Optics™, VP3 Vivid Color™ and VP3 Natural White™ technology imbedded in the engine, we have brought brilliance to light,” said Susan Larson, VP of OEM Sales at Soraa. “Fixture manufacturers everywhere now have a true source of design inspiration.”

Soraa’s Point Source Optics™ technology produces beautiful, high-intensity and uniform beams within a very slim form factor. Narrow spot options at 10 degree or narrower are offered with an unprecedented low profile of only 16 mm for 500 lumens, and 28 mm for 1,000 lumens. The optics technology also enables the offering of a unique 4 degree ultra-narrow spot version that is as low as 28 mm.

Soraa’s Violet-Emission 3-Phosphor (VP3) LED technology allows for perfect rendering of colors and whiteness. Utilizing every color in the rainbow, especially deep red emission, Soraa’s VP3 Vivid Color™ renders warm tones beautifully and accurately. It achieves a color-rendering index (CRI) of 95 and deep red (R9) rendering of 95. The VP3 Natural White™ is achieved by engineering the violet emission to properly excite fluorescing brightening agents including natural objects as well as manufactured white materials.

GL SPECTIS 1.0 touch

the world's first smart spectrometer



- » precise measurement of single LEDs
- » luminous flux and radiant power measurement with GL OPTI SPHERE 48
- » perfect for quality control of LED production
- » intuitively operated touch screen



Visit us
Booth # 3528

GL OPTIC Light measurement solutions

Soraa's new Optical Light Engines are available in three sizes 11, 16, 30 (or 1.5"- 37 mm, 2"-50 mm, and 4"-100 mm diameters); lumen outputs of 500 or 1000; 4 degree, 10°, 25°, and 36° beam angles; 2700 K, 3000 K, 4000 K, and 5000 K color temperatures; and with an optional heat sink. Additionally, Soraa's narrow spot beam light engines work with its award-winning magnetic accessory SNAP System. With a simple magnetic accessory attachment, beam shapes can be altered and color temperature can be modified, allowing endless design and display possibilities. ■

make use of the efficiency from each chip and at the same time save the cost and space wasted on the PC board. This design could provide professional commercial and home lighting fixtures a better solution to bring out a higher efficiency within limited space without causing light spots or asymmetric viewing angle issues like traditional DoB modules.



Ledtech's DoB modules were demonstrated at LED EXPO India last December

Ledtech Offers New Driver On Board Light Engine

As a leading supplier of LED low temperature lighting and CoB (Chip-On-Board) components, Ledtech Electronics has applied its advanced technology in high wattage CoB modules and develops a brand new ceramic based Driver On Board (DoB) light engine module which is far way different from existing SMD type DoB modules. Ledtech's new design on DoB could better

Ledtech's ceramic based DoB series is not only better in design of viewing angle and efficiency but we also put a lot of effort in LED protection devices to make sure our partners get the most reliable products. With 200 to 240 VAC direct input, Ledtech's DoB features in protection devices from soft start, over voltage protection), to heat compensation.



HONGLITRONIC
鸿利光电
Stock Code: 300219

We are Leading White Light LEDs



LED Filament 360°

- Sapphire substrate

COB

- LM-80 certified
- Ranging from 3w to 150w

EMC LED

- LM-80 certified
- Ranging from 0.5w to 2w

2835

- LM-80 certified
- 0.2W-2W PPA-PCT-EMC product portfolio

2016

- Ranging from 1w-3w
- Application: photo flash, mobile flash, portable lighting

1400KK Pcs month production capacity
First manufacturer in China to pass the IES LM-80
EPA Recognized certification laboratory



Welcome to Electronica 2015 LIGHT(Warsaw)
Booth: Hall4-D9 Date: March 25-27th, 2015

Guangzhou Hongli Opto-Electronic Co., Ltd

E-mail : sales@honglitrionic.com
Tel : +86-20-8673 3333 ext 3033
Fax : +86-20-8673 3883



www.honglitrionic.com

Official website Official wechat

In addition, the standard dimension of Zhaga has also been adopted by Ledtech DoB series. From settings with a diameter of 40 mm (Book 11), 50 mm (Book 3) to 75 mm (Book 10) of our circle shape PCB we could work easily with big names in the LED lighting industry, allowing customers to change light source in fixtures as easy as changing a light bulb. Ledtech has shown their great ambition by dauntlessly competing with industry giants to provide premium light sources and fight for a higher market share in LED components.

Ledtech and its subsidiary Energyled attended the great LED EXPO in New Delhi last December and demonstrated the brand new premium DoB module on site. Many of the international and local distributors and agents were extremely keen to get the price and excited about this new module released in the market.

Ledtech's premium DoB light engine can provide lighting output from 3 W to 45 W with 90 lm/W, PF>0.9, CRI >85 and all these features allow the most popular home lighting products like bulbs, track lights, down lights and bay lights compatibility with some authentic and well-designed light fixtures with limited space. ■

MechaTronix Launches Universal LED Cooler for BJB LED Module

The BJB LED star cooler GH36d is specifically designed for luminaires using the BJB GH36d series LED modules and various brands of COB LED modules mounted by BJB Zhaga Book 3 or Zhaga Book 11 LED holders. The compact module GH36d consists of a based and encapsulated LED lamp with suitable Twist&Lock lamp holder.

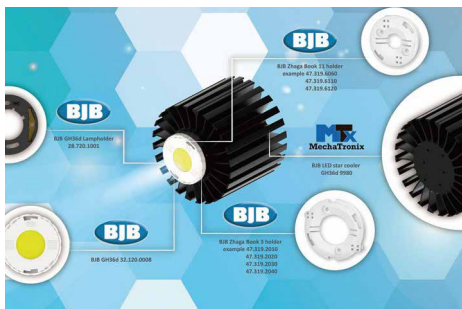

MechaTronix's star cooler GH36d accommodates all versions of BJB modules and holders

The pre-tensioned leaf springs, which are fixed with two standard screws, ensure a defined contact pressure of the light source to the heat sink and thereby constant heat dissipation.

The versions with 1,200 lm, 2,000 lm, and 3,000 lm luminous flux, as well as with 3,000 K and 4,000 K color temperature, enable easy entry with low-maintenance, flexible LED solutions in shops, offices and the hospitality field.

With a thermal resistance of 1.1°C/W in a diameter of 99 millimeter, the BJB LED star cooler offers a perfect passive cooling platform for luminaires up to 5000 lumen. Through a modular mounting pattern the GH36d LED cooler offers a wide platform of mechanical exchangeability - including Zhaga book 3 and Zhaga book 11 mounting platforms.

Specific on this design is the advanced performance under tilted positioning. While most star shaped LED coolers lose over 30% of their cooling capacity once tilted over angles of more than 40 degrees this design is optimized for tilting luminaires like track spots and globes. ■

Heraeus Introduces CoolStrates™ PCBs

Heraeus Electronics, a world leader in electronic packaging materials and technology, will soon unveil CoolStrates™, a new line of circuit boards made with Celcion™ Thick Film Paste. These innovative boards utilize cooler aluminum substrates, resulting in improved thermal management, performance and cost in LED systems.

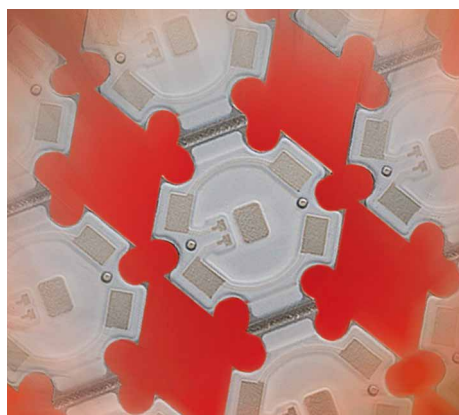

Heraeus calls its latest thermal management innovation CoolStrates™

CoolStrates™ allow customers to easily apply the LED chip, thus reducing steps in the manufacturing process and enabling more efficient production. They are available for chip-on-board, chip-on-heatsink and standard packaging technology.

"We are constantly seeking ways in which we can improve our products and processes for customers with cutting edge innovation and ideas," said Mark Challingsworth, R&D Manager at Heraeus. "We feel we've done just that with CoolStrates™, and we are looking forward to introducing it to the market."

The Celcion components used in CoolStrates™ are recognized by Underwriter Laboratories (UL®). ■

Fischer Introduces Active Heat Dissipation System for LEDs

Fischer Elektronik is now specifically expanding its comprehensive product portfolio for weight-sensitive applications with an active LED heat dissipation concept. It allows easy mounting for Zhaga-compatible modules and uses a special low-noise fan.



While Zhaga-compatible modules can be mounted directly to the heat sink, for other modules and holders, a pre-threaded mounting plate is available

The lifetime of LEDs directly depends on the heat dissipation concept. Drastic temperature fluctuations will considerably shorten it, and overstepping the permitted chip temperature has a direct impact on the light yield. The use of extruded aluminum heat sinks for free convection already serves as an effective LED heat dissipation concept.

With an active LED heat dissipation concept under the article number LA LED 68, Fischer Elektronik expands its product

portfolio for weight-sensitive applications. The base is made from a thermos-technically optimized aluminum hollow-chamber profile. Zhaga-conform LED modules can be directly bolted to the front of this by way of additional threads. There is also the option of fastening various LED modules from different manufacturers, as well as their holder systems, to the pre-threaded mounting plate with the help of an adapter screwed into the base section.

A special low-noise fan motor in a round design is integrated in and fastened to the back of the base section. The motor has a double slide bearing and is designed for the special requirements of LED applications where noise and lifetimes are concerned. Mechanical processing, cover panels with ventilation slits, customized designs and surface coatings are also all available for your application. ■

Infinion ICL5101- HV Resonant LED Controller with PFC

Introducing the ICL5101, Infineon Technologies AG extends its portfolio of lighting control ICs, addressing lighting systems in the range of 40 W to 300 W. The new high-voltage resonant controller IC provides a high level of integration which translates to a reduction in system cost. Typical applications which benefit from these features include indoor and outdoor LED lighting, high-bay and low-bay lighting, street lighting, parking garage and canopy lighting, office lighting, retail and shop lighting. Since the total cost of ownership is an important aspect for industrial lighting, customers prefer to use resonant topologies supported by the new ICL5101 due to its high efficiency up to 95%.



Infinion's ICL5101 is targeting indoor and outdoor high-power LED lighting applications like high-bay/low-bay lighting or street lighting

The highly integrated ICL5101 allows for advanced LED driver designs with approximately 25% less components compared to similar solutions which require separate PFC and resonant ICs. This leads to smaller form factors with more reliable designs, less complex PCB layouts and reduced costs. The ICL5101 integrates the half-bridge and the PFC gate drivers. All operation parameters of the IC are adjustable by simple resistors, enabling cost effective but reliable and stable parameter-settings. The chip supports outdoor use by an extended junction temperature ranging from -40°C to +125°C.

The LED controller ICL5101 is designed to control resonant converter topologies such as LLC. The integrated digital PFC stage operates both in critical conduction mode (CrCM) and discontinuous conduction mode (DCM), which allows an extremely stable regulation in low load conditions, occurring, e.g. when the device is dimmed. The LED lighting can be dimmed down over an extremely wide range from 100% to 0.1% of its nominal load. State of the art dimming today typically ranges from 100% to 5%. In addition, the ICL5101 enables a fast time to light - under any conditions - with less than 200 ms.

The adjustable PFC stage of the ICL5101 delivers high power quality, providing a low total

EPISTAR

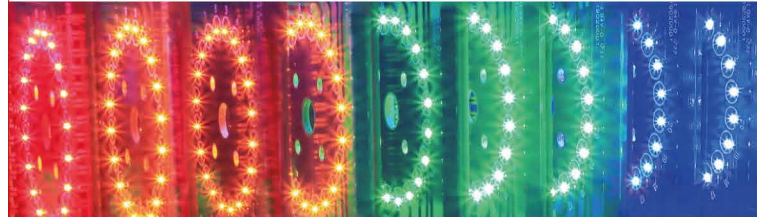

TAIWAN INT'L LIGHTING SHOW

Date

25.03.2015 - 28.03.2015

Location

Nangang Exhibition Hall,
Taipei

Booth

Area M 0320



EPISTAR Corporation
5 Li-hsin 5th Road, Hsinchu Science Park,
Hsinchu 300, Taiwan
T: +886 3-567-8000 F: +886 3-579-0801
sales@epistar.com.tw www.epistar.com



Website Facebook

harmonic distortion (THD) of less than 10% and a high power factor of more than 0.99 over wide line input voltage range. This enables lighting manufacturers to comply with energy efficiency standards. Furthermore, the output of the ICL5101 is extremely stable over line voltage variations. A comprehensive set of protection features including external over temperature protection and capacitive load protection ensure the detection of fault conditions and increase system safety. ■

EnOcean Launches Complete Wireless LED Control System in the US

LED lighting is one of the most promising and fast-growing technologies of today. EnOcean, the leading provider of energy harvesting wireless solutions, announces a comprehensive LED control system for the North American market based upon innovative self-powered sensors and switches, combined with LED fixture controllers and commissioning tools to simplify installation and setup.



The comprehensive LED control portfolio is based on the widely adopted energy harvesting wireless standard

The building blocks include:

- LED controller family: the transceiver module (TCM 330U) for integration into drivers and modules as well as LED Fixture/Zone Controllers with relay and 0-10 V output, and without relay
- Comprehensive application firmware enabling dimming, occupancy, daylighting and Title 24-compliant controls right out of the box
- Navigan, an easy-to-use commissioning tool to link devices and setup parameters over the air from a graphical user interface
- EnOcean's established line of white label self-powered wireless switches, occupancy and light level sensors

Faster time to LED market:

With this offering, EnOcean's OEM customers benefit from significantly shorter development timelines and reduced investment, enabling them to focus on the quickly evolving LED market opportunities. Employing EnOcean modules, OEMs can develop products on their own, leveraging established LED control applications. Those OEMs seeking a ready-to-use solution can employ finished products to speed time-to-market and reduce development effort.

Wireless control and daylight harvesting:

The new LEDR/LEDD controllers use wireless technology to communicate at 902 MHz with other self-powered EnOcean-based products. It provides a simple solution for dimming control of a single fixture or a zone of multiple daisy-chained LED fixtures. In addition, it supports daylight harvesting scenarios, occupancy control and manual dimming processing data from EnOcean-based self-powered wireless occupancy sensors, light level sensors, and switches. The compact size enables flexible installation inside of or next to electrical boxes and fixtures so it can be easily wired out of sight using standard wiring practices.

Users can connect the LEDR/LEDD controller to a central controller or a gateway to integrate lighting control into building automation systems. Alternatively, the TCM 330U transceiver module can be implemented into existing controllers. It already includes the firmware to get immediately started with wireless control.

Easy setup and remote configuration:

LEDR/LEDD provides a very simple manual user interface for configuration and linking of devices. With only two buttons, the user can link and unlink sensors and switches, to dim up and down manually, and to set the minimum dimming value.

For the LED lighting configuration of advanced settings, EnOcean offers the easy-to-use wireless Navigan remote commissioning software to link devices and set parameters (e.g. ramp speeds, dimming levels, integrated repeater etc.) from a laptop computer. Using the Navigan commissioning tool, installers can easily configure the LEDR/LEDD controller over the air in accordance with on-site requirements, define properties and settings as well as edit and store projects.

Access to a standardized ecosystem

A unique strength of the EnOcean LED control portfolio is its compatibility with the strong EnOcean Alliance eco-system. OEMs have access to hundreds of automation products and solutions based on the leading EnOcean wireless standard and standardized application profiles. This huge range of interoperable wireless self-powered devices is already established on the market and offers LED control a consequently standardized communication. With the comprehensive EnOcean LED control portfolio, OEMs can fall back on this broad line of interoperable products to create a flexible LED control solution meeting specific customer requirements.

Both LEDR and LEDD controller employ the Remote Commissioning certification recently defined by the EnOcean Alliance, which provides a common framework for over the air linking and configuration of EnOcean-based networks. ■

New 480 V High Wattage LED Drivers from TRP

Thomas Research Products has introduced new 277-480 V LED drivers with 96 W output. This eliminates the need for step-down transformers inside luminaires. Thomas Research Products is a leading manufacturer of SSL power solutions.



TRP's PLED96W LED driver perfectly accommodates both high wattage indoor or outdoor LED luminaires

New PLED96W-HV series drivers are based on TRP's high performance PLED96W series. Providing flicker-free output, these drivers are perfect for high wattage indoor or outdoor LED luminaire designs. Available in constant-current, dimmable, and constant-voltage versions, the new High Voltage drivers work on any mains from 277-480 Vac. This makes them perfect for 347 V applications.



瑞豐光電

Stock Code:300241

**EMC provide mid-power LED products
with high quality
and performance**

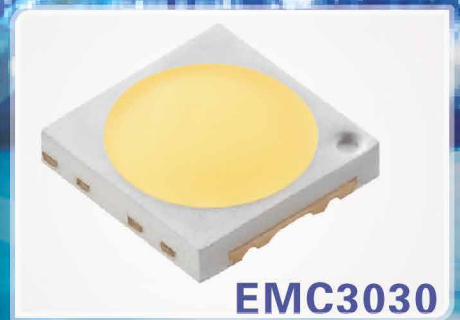
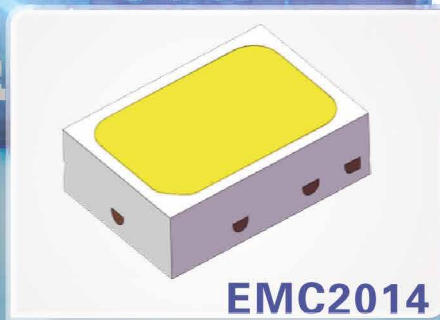
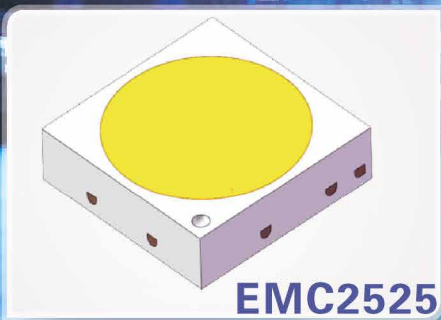

深圳市瑞豐光電子股份有限公司

SHENZHEN REFOND OPTOELECTRONICS CO.,LTD.

ADD : Building #1, 10th Industrial Zone, Tian
Liao Community, Gong Ming Area, Guang
Ming New District, SHENZHEN, CHINA

TEL:0755-66839118 FAX:0755-66839300



www.refond.com

The driver design is robust enough that it also qualifies for hazardous locations. These models are Type HL rated by UL. Even though not all applications require this rating, it provides OEMs assurance that these drivers will perform in a variety of environments.

TRP's new drivers offer the same features as their regular PLED drivers, including Black Magic Thermal Advantage™ aluminum enclosures. They are also IP66, rated for dry and damp locations. ■

Vishay - Integrated Tiny RGBW Color Sensor with I²C Interface

The Optoelectronics group of Vishay Intertechnology, Inc. introduced a new digital RGBW sensor featuring Filtron™ technology for accurate RGBW spectral sensitivity while providing ambient light spectral sensitivity with responses close to that of the human eye. Vishay Semiconductors' VEML6040 incorporates photo-pin-diodes (RGBW) and a signal processing IC in a compact 2.0 mm by 1.25 mm by 1.0 mm surface-mount package while offering an I²C bus interface for simple operation.

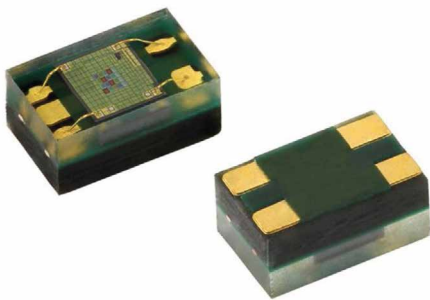

Vishay's Filtron™ sensor technology offers an excellent RGBW spectral sensitivity

The device released today senses red, green, blue, and white light, and it offers 16-bit resolution for each color channel. The VEML6040 is ideal for consumer devices such as smartphones, digital cameras, and televisions, where it allows the brightness and color temperature of backlighting to be adjusted based on ambient light, making LCD and LED panels more comfortable for end users' eyes. Containing the circuitry needed for color balancing, backlight control, and color temperature measurement in one device, the sensor saves space, lowers costs, and simplifies designs by eliminating the need for an external resistor.

The VEML6040's built-in ambient light photo-diode offers extremely high sensitivity, with detection from 0.0056 lx to 11.7 klx, allowing the device to operate in applications with dark lens designs. The sensor provides fluorescent light flicker immunity, low power in shutdown mode of < 1 µA, and excellent temperature compensation stability from -40°C to +85°C.

The device features an operating voltage and I²C bus voltage range of 2.5 V to 3.6 V and is offered in a lead (Pb)-free, 4-pin OPLGA package. The VEML6040 is RoHS-compliant, halogen-free, and Vishay GREEN. ■

Tridonic connecDIM - Decentralised Light Management 2.0

Tridonic unveils connecDIM, an easy-to-integrate light management system solution for industry and commerce. The system, comprising connecDIM Gateway and connecDIM Cloud, combines cost efficiency and user-friendly design with decentralized light monitoring and control options from anywhere in the world. Small applications with only a few DALI devices can benefit just as much as complex lighting systems.



Based on standard hardware and internet technologies, Tridonic's connecDIM is a cost effective smart controls solution

A long-term study conducted by Zumtobel in cooperation with the Fraunhofer IAO has confirmed that the present lighting situation in offices often does not meet the requirements of the various groups of users. Lighting that is tailored to the needs of users has been shown to improve their well-being and make workplaces more attractive. More than 50 percent of all employees would like individually adjustable lighting that they can tailor to their specific needs and to the requirements of changing work situations. connecDIM makes this possible. This light management solution not only enables the

lighting to be monitored at any time and from anywhere in the world, it also allows employees to adjust the lighting to suit their own individual needs quickly and easily via a PC or smartphone app. Both the intensity and the light color (Tunable White) can be adjusted, thereby making employees feel more comfortable at work, as those who took part in the study can testify.

Whether the DALI system is a new one or an existing one, integrating it in a high-level light management system via the connecDIM Gateway is much easier, quicker and more cost-effective than has ever been possible with other approaches. This solution is based on standard hardware and internet technologies so there is no need to invest in expensive specialist hardware or software. connecDIM is easy to install, operate and tailor to individual customer requirements, and offers automated emergency lighting test functions. Once connected to the internet, the gateway, as the heart of the system, collects all the data and parameters of the connected DALI devices and transfers them via TCP/IP to the central ConnecDIM cloud.

The data stored in the cloud can be accessed at any time from anywhere in the world. Access is possible via web browsers from any PC or Mac, and also wirelessly via tablets or smartphones running iOS or Android. There are apps available for wireless access, namely connecDIM Lite for monitoring and controlling the installation within the property via the in-house WLAN and connecDIM Architect for commissioning and maintaining the installation.

Building operators, facility managers and operation and maintenance personnel all benefit from the central monitoring functions. Not only do they receive an overview of the connected DALI devices, they can also see any lamp faults, hardware faults and dimming values at a glance so they can immediately take appropriate action. It is also possible to change the energy consumption without having to be on site.

If the luminaire installation is expanded additional DALI devices can be easily integrated via a PC or Mac internet connection or wirelessly via a tablet or smartphone. This involves addressing the devices, defining test routines (for example for emergency lighting operation), setting up predefined lighting scenes and controlling the light color in the case of tunable white. ■

ams Combines Daylight Sensor & Lighting Manager to an IoT-Hub

ams AG, a leading provider of high performance analog ICs and sensors, introduced its revolutionary AS721x Autonomous Daylighting Manager, the industry's first integrated chip-scale Internet of Things (IoT)-connected smart lighting manager. This new class of sensor-integrated smart lighting manager solutions delivers cost-effective, IoT-connected integrated control capabilities to luminaire, light engine and replacement lamp manufacturers. A Smart Lighting Integration Kit (SLIK) allows for easy and quick implementation.



To get started, ams offers the Smart Lighting Integration Kit (SLIK)

Attributes of the ams' AS721x Autonomous Daylighting Manager:

- 20-pin 2.1 x 2.3mm chip-scale and 4.5 x 4.7mm land grid array package options
- Photopic daylighting sensor for accurate ambient light sensing and control
- Integrates with industry standard 0-10V controls, driving 0-10V and multi-channel PWM outputs
- Standard serial UART (AS7211) for expansion to any standard networking or integrated IR remote control decoding (AS7210)
- Network-enabled architecture with a high-level, driverless smart lighting command set for IoT connectivity via Bluetooth 4.x (BLE), ZigBee, WiFi, Ethernet/PoE or other networks
- I²C sensor expansion creating lighting-hosted sensor-bridge capabilities

Photopic sensors built with nano-optic filters integrated into the AS721x series are designed to help lighting manufacturers address the growing challenges of energy-saving lighting mandates, including daylighting controls. These challenges are more cost-effectively met by bringing the controls and high-granularity sensing into the luminaires themselves.

The AS721x family is ams' first platform technology of integrated sensor solutions that provide system-level sensing and control capabilities, greatly reducing system costs and shortening time-to-market. The AS721x Autonomous Daylighting Manager senses the ambient daylight and enables the delivery of constant lux levels in the space by managing subtle adjustments as the amount of outside light varies. Integrating a sensor-based manager into each luminaire optimizes the overall responsiveness and efficiency of the lighting system, maximizing energy savings. The approach also delivers accurate lumen maintenance over time and temperature variations, and allows fully connected luminaire systems to respond to building- or space-level command and control strategies.

Lextar

Lextar Electronics

The Smaller, The Better!

Tiny size, Better performance

Lextar 3014 provides only quarter size of 5630 with more competitive cost. Offering high efficacy up to 170 lm/W with 50,000 hrs long life. The most economic options for various linear applications.



3014

- LM-80 certified LED
- High efficacy & high lumen output
- Delivering uniform light
- Best performance and cost for linear application
- Dual design - top / side view



Lextar.com

Sales.LT@Lextar.com

guangzhou international
lighting exhibition
9-12 June 2015



Hall 10.2
Booth No. C19

Competitive offerings in the space are essentially “build your own” devices requiring discrete components, including sensors, processors, memory, and I/O chips, that require design, integration and time-consuming programming of control and communications algorithms. In contrast, the AS721x family delivers a fully integrated solution, providing users with a high level of integration at far lower cost and complexity. “ams’ ground-breaking sensor-integrated manager series addresses head-on the lighting industry’s desire for technically feasible integrated controls that are also cost- and space-effective. It’s a solution that will truly revolutionize the lighting industry, and deliver the kind of network-connected system approach that exemplifies the power of the Internet of Things,” said Brian Bedrosian, Senior Director, Product Marketing of Broadcom, which is providing Bluetooth Low Energy (BLE) Smart connectivity for the IoT-connected AS721x series.

Code Mercenaries - New 4 Channel Intelligent LED Driver

Code Mercenaries introduces a 4 channel, intelligent, and programmable LED driver. LED-Warrior04 has I²C, DMX512, and DALI interfaces. Bluetooth LE can be added with a piggyback module.

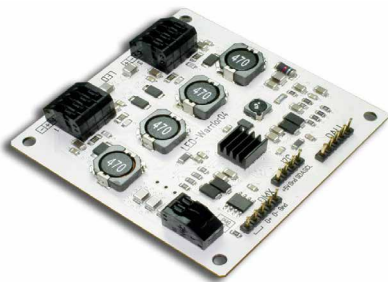

Code Mercenaries' LED-Warrior04 is a 4 x 25 W intelligent, and programmable LED driver with I²C, DMX512, and DALI interfaces

Technical data:

- DALI to PWM controller
- According to DIN EN 62386-101/-102/-207
- All protocol elements implemented
- PWM output at 500 Hz
- PWM dimming from 0.1 % to 100 %
- Logarithmic and linear dimming curves
- Available as module or DIL8/SOIC8 chip

For each of the four channels the forward current and brightness of the LEDs can be individually and independently programmed. Current can be programmed from 200 mA to 1000 mA in steps of 5 mA. Brightness is controlled by internal 12 bit PWMs for each channel, allowing 4096 steps.

Programmability of the LED forward current enables the use of a single type of driver for a wide range of LEDs. The high resolution of the brightness control allows precise color mixing or calibration of multiple LED groups.

I²C, DMX512 and DALI are available for control of the four channels. The I²C interface also allows programming the LED-Warrior04 for stand-alone operation.

The I²C interface may be used for service to recalibrate already installed units. Light scenarios can be programmed for stand alone operation, to run independent effects like fading or color change. LED-Warrior04 operates with DC input from 7 V to 32 V and drives up to 4 x 25 W to the connected LEDs at up to 94% efficiency. ■

Billion Electric Offers Smart Lighting Solution and LED Driver

Billion Electric Co. Ltd. announces the launch of Smart Lighting Control Management System (LCMS) and High Efficiency Class 2 Drivers to the global LED Lighting market. Continuing the cooperation with lighting

technology leader Everlight Electronics, Billion develops its wholly owned Street Light Control Management System (LCMS) that provides automatic dimming schedule, streetlight status diagnosis, and remote control for streetlights operation. Besides the new streetlight control solution, Billion develops a rich selection of LED Drivers serving as outperforming power supplies and essential engines for the operation of solid lighting systems.



Billion Electric's smart Lighting Control Management System (LCMS) basically consists of the Smart Lighting Transceiver (A), a Gateway (B), online server (C) and an operator control software (D)

To achieve lifetime sustainability and energy efficiency, Billion's LED Drivers are compact, versatile, and reliable, supporting a broad range of indoor and outdoor lighting applications. The high quality LED Drivers are available in Constant Current and Constant Voltage varieties; non-dimming and dimming drivers; PWM or 1-10v dimming; and various application specific products, including those designed for the signage market.

Billion's Class 2 LED Drivers are exclusively installed with power isolation mechanism and have a current leakage smaller than 0.25 mA. With the designed functionality, Billion's Class 2 LED Driver is able to provide more user safety and overheat protection than other LED driver brands in the market. The Billion's Class 2 LED Drivers serve as power dimmable lamps and are easy to deploy for various lighting scenarios. ■



Putting LEDs in the Right Light

SSL solutions from the world leader in LED measurement.

- **Spectroradiometers**
Unprecedented photometric and colorimetric accuracy
- **Goniophotometers**
Three models for different sample sizes
- **Integrating Spheres**
Ranging from 25 cm to 2 m in diameter
- **Imaging Photometers and Colorimeters**
Homogeneity of extended sources and OLEDs

Instrument Systems
light measurement

www.instrumentsystems.com

IS LumiCam 1300 Advanced - Six Filters for Precise Color Measurement

German specialist for light measurement solutions Instrument Systems presents the LumiCam 1300 Advanced. This new imaging photometer and colorimeter has been designed for the highest accuracy when analyzing the characteristics of displays and electronic panel graphics.



Instrument Systems' LumiCam 1300 Advanced provides more accurate measurement and eye sensitivity curve adjustment with its six channels

The innovative camera concept of the LumiCam 1300 Advanced is based on six filters. Alongside the four optical filters used in the LumiCam 1300 Color, the new camera has been expanded by two filters. The patent-pending procedure allows very accurate adjustment to the eye sensitivity functions using the data recorded from the six channels.

The LumiCam 1300 Advanced provides excellent accuracy for the color coordinates particularly when taking LED color measurements. Therefore it offers a good alternative to spectroradiometric instruments with significantly shorter measurement times.

The LumiCam 1300 Advanced is the third member of the LumiCam family and complements the proven camera models LumiCam 1300 Mono and Color with a further imaging measurement system. If required, the advanced model can be operated in exactly the same way as the Mono or Color versions - with analog measuring times and accuracies. The relevant operating mode can easily be selected in the software.

The LumiCam software also provides a comprehensive range of tools for evaluating the test results. Luminance, luminous intensity, contrast, color coordinates and dominant wavelength can be determined within seconds. Different manual and automatic analytical tools operate on configurable regions of interest and allow for clear visualization. ■

New Multi-Exposure (HDR) Feature for Imaging Photometers

SphereOptics introduced a new "multi-exposure" feature (also known as "HDR" or High Dynamic Range mode) for their I- and Y-Series ProMetric™ imaging photometers made by Radiant Vision Systems. Radiant Vision Systems, formerly known as Radiant Zemax, is well known for their ProMetric™ high performance imaging photometers and colorimeters (cameras which measure the amount and color of light) which are widely used in the development and testing of flat panel displays, lighting, LEDs and in vehicle lighting applications.

HDR off HDR on

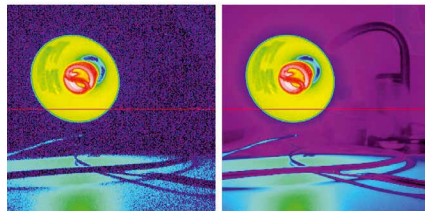

The new HDR function of SphereOptics' I- and Y-Series ProMetric™ imaging photometers offers a similar effect as in ordinary photo cameras extending the dynamic range while reducing image noise

The new HDR mode increases the dynamic range of the ProMetric camera significantly (up to 1,000,000:1).

The newly developed algorithm achieves this range extension by combining separate images with different exposure times. This method increases the grey scale range of the image while at the same time, lowering the noise level.

The accuracy of the measured luminance and color remains very high, with a percentage error of +/- 3 % for luminance (cd/m^2) and color coordinates x, y of +/- 0,003.

ULTIMATE PERFORMANCE IN AN LED LIGHTGUIDE.

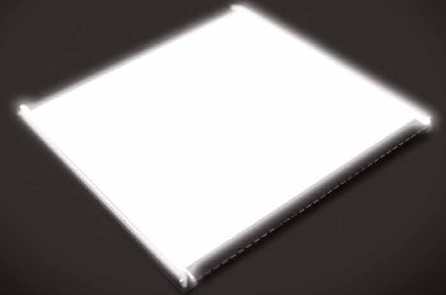

low cost
thin
durable
long life

excellent uniformity
large range of sizes



www.glthome.com

See Us at LightFair in Booth 3909



UE Electronic
Since 1989

24W indoor LED driver
(UE24WZ1-A1Z)
3-24V DC 0.1-3A
TUV(LED EN61347), CE

PSB BSMI SABS WEEE ISO 14001:2004
ISO 9001:2008 CEC OHSAS 18001:2007

CB CCC CQC UL US SP US FC
CE JET TLC GS DZMC

Fuhua Electronic Co., Ltd
Fuhua Electronic Industrial Park, Xianglong Rd.,
Huangzhou New Town, Shilong, Dongguan,
Guangdong, China
Tel: (86) 769-8602 2222 Fax: (86) 769-8602 3333
www.fuhua-cn.com E-mail: fuhua@fuhua-cn.com

The multi-exposure HDR feature allows for a more accurate luminance analysis of a device under test that features both low and bright light illumination levels simultaneously. A good example of such an application is the measurement of emergency signs when looking simultaneously at the sign and at the light pattern on the wall. Other examples are street lights and their pattern on the street or on the pavement, where the HDR mode allows for the measurement of the illumination pattern as well as the light emitted directly from the lamp. ■

Labsphere Introduces New Uniform Light Sources for Calibration

Every day improvements of cameras and sensors in terms of color perception and resolution lead to higher requirements in quality assurance and production control. Labsphere's new series of uniform light sources CCS-1000 is dedicated to camera and sensor calibration in the production line.

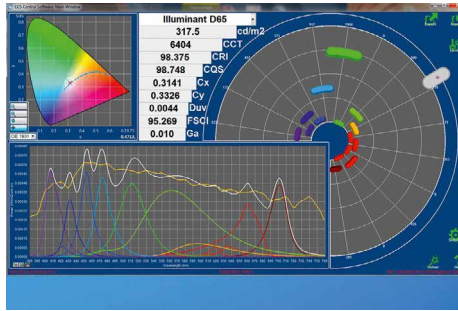

Screenshot of Labsphere's CCS-1000 system SW interface

Traditionally flat fielding and other camera and sensor corrections were made with uniform sources including a halogen light source, due to the constant output of halogen lamp over time and the well-known linear spectrum. But because of the change in time and the replacement of traditional light sources with LED sources there is a demand to adapt calibration equipment as well.

Cold white LEDs consist of a blue LED with a yellow phosphor layer on the top. Therefore, they have a large peak in the blue range which does not appear in case of a halogen spectrum. As the calibration scenario shall be as close as possible to the later usage of the devices, it is important to adapt the integrating sphere systems.

Labsphere's latest series of CCS-1000 systems replaced the halogen source, inside the high reflectance integrating sphere, made out of the material Spectralon™, by 16 LEDs distributed over the VIS and NIR range to generate almost every spectrum. Standard sources like illuminant A, B, C, D50, 55, 65, 75, F2 and F12 are set as defaults; customer specific spectra could be composed easily. ■

Nora Lighting Adds New Light Channels to Their Product Portfolio

Nora Lighting introduces a new series of LED Tape Light Channels that expand the versatility of the Nora tape light product line. The channels can be recessed or surface mounted in interior walls, hallways and stairways or within railings and ceilings. They can also be mounted under cabinets for energy-saving LED lighting in homes or offices. The channels are available in 4-foot lengths, which can be joined for longer runs. Six models are offered with various channel depths, including a corner model.



Nora Lighting offers six LED Tape Light Channel models with various channel depths, including a corner model

Constructed from aluminum, all channels include end caps and a white diffuser panel to soften the LED lighting effect. The new channels accommodate the complete line of Nora LED tape lights, which are available in white or amber. They include: Hy-Brite LED Tape Light; Standard LED Tape Light; High Output LED Tape Light; Side-Lit LED Tape Light; along with RGB Color Changing LED Tape Light.

Nora Lighting is an innovator in the introduction of LED products and now offers LED retrofit downlights; LED track and rail fixtures; LED puck lights; LED pendants; LED step and brick lights; and LED emergency / exit signs.

Along with LED fixtures, Nora manufactures incandescent, fluorescent and HID sources in track and rail systems, recessed lighting, multiple lighting systems, under cabinet and an expanding series of accent lights, including pendants and sconces. ■

Green Creative's New BR30 LED Lamp with "Cloud" Design

Green Creative, the commercial grade LED lighting manufacturer proudly announces the launch of its new BR30 8 W LED lamp. The BR30 8 W Cloud is the latest addition to Green Creative's Titanium LED Series 4.0 and was selected by the Illuminating Engineering Society (IES) for its prestigious 2014 Progress Report. Green Creative had five lamps chosen for the 2014 Progress Report which showcases unique and innovative products significant to the lighting industry.



Green Creative's BR30 LED Cloud, offers the same quality and features of their other products in an innovative lightweight design

Weighing less than 100 g, the BR30 Cloud features a revolutionary design that is 60% lighter than the previous generation BR30. This dimmable lamp emits smooth and evenly distributed light and is one of the only BR30 65 W replacements available that is suitable for use in totally enclosed fixtures. Its traditional incandescent form factor makes it an ideal choice for recessed, accent and general lighting applications.

"The BR30 Cloud is more than just a uniquely designed product," says Green Creative's Principal, Cole Zucker. "It uses 35% less material than our previous generation but at the same time raises the bar for energy efficiency in the market."

At 81 LPW, this lamp's efficacy is more than 20% higher than the Tier 1 LED 65 W replacement industry average and exceeds Energy Star® requirements. The BR30 Cloud

is Energy Star certified, dimmable, lasts 25,000 hours and is available in 2400 K, 2700 K, 3000 K and 4000 K CCT.

Green Creative will be releasing a full line of BR lamps utilizing the Cloud design in the coming months. ■

Verbatim's Dichroic LED Lamps Deliver High-Quality Light Beams

Verbatim has unveiled dichroic-effect LED lamps as cost-effective replacements for dichroic halogen lamps. Using technology developed by parent company Mitsubishi Chemical Corporation, Verbatim has provided an energy-efficient alternative to the MR16 and PAR16 halogen lamps popularly used for track lighting, pendant fixtures and retail display lighting to produce a unique, surround lighting and glitter effect.



Verbatim's dichroic MR16 LED lamp with GU5.3 base as well as the GU 10 LED lamp version delivers excellent optical control

Some LED manufacturers have found it very difficult to replicate dichroic lighting largely due to the necessity of a sizable heatsink. Verbatim's new high quality dichroic MR16 and PAR16 lamps deliver a high quality beam without any noticeable heatsink in sight and as a result it fits neatly into standard fixtures while providing all the energy saving benefits of LED lighting.

Verbatim's 3.7 W dichroic MR16 LED lamp with GU5.3 base delivers excellent optical control with minimal spill and a crisp 35° beam angle focusing light where it's needed. A 4 W dichroic PAR16 lamp with GU10 base is also available offering the same beam angle. Besides delivering a higher power output and light intensity, its 3000 K warm white color temperature, 480 cd luminous intensity and luminous flux of 250 lm at 90° angle are all of equal measure to the MR16 lamp. Competing LED products in the market tend not to deliver as much of a glitter effect from the dichroic mirror they employ.

"Making dichroic-effect LED MR16s without a noticeable heatsink and delivering high performance, reliability and quality at the same time isn't easy. Verbatim has delivered yet another outstanding product that our customers tell us more than matches their needs. Verbatim has introduced many high quality, innovative LED products in recent months and we are looking forward to unveiling many more high-performance spotlights in 2015," commented Jeanine Chrobak, Business Commercial Manager LED EUMEA, Verbatim. ■

LED PAR LAMP RANGE

The perfect replacement of traditional halogen Par lamps, emitting the same amount of candela power while only consuming 12% of the energy.

Available in shape of Par16/20/30s/39L/38, narrow flood and wide flood, CCT 2700-6500K, Color Rendering Index of 80/90/95 optional.

Accurate optical design for best performing beam control.

High quality surface finishing and artistic shape, wet location rated design, suitable for shops, exhibitions, hotels, restaurant and so on.

UL and ENERGY STAR® certified.

DANGOO



PAR 16



PAR 20



PAR 30s



PAR 30L



PAR 38

Dangoo Electronics

www.dangoo.com.cn | info@dangoo.com.cn | Tel: +86 (21) 5426 4988 | Fax: +86 (21) 5426 4977

Global Offices: Asia | USA | Europe



Osram Improves Efficiency of Blue LED Chips by Reducing Forward Voltage

Osram Opto Semiconductors has achieved one of the best values in the world in terms of forward voltage for blue high-current chips. This has led to an increase in efficiency of up to eight percent. Optimized InGaN chips (Indium-Gallium-Nitride) featuring UX:3 chip technology are the basis for blue or white LEDs – and are already used in production. Osram experts also see considerable potential for reducing the value by a further 20 to 30 millivolts (mV) by the summer of 2015 – offering a further boost in efficiency.

The blue Osram Oslon Square (LD CQAR), for example, now has a typical forward voltage of only 2.87 volts (V) instead of the 3.05 V specified so far in the data sheet – the

lowest typical values in this component class worldwide. At 85° C a voltage of 2.78 V can be achieved in the component. Depending on the operating point, this translates into an increase in efficiency of these light emitting diodes (LEDs) of six to eight percent, which can be transferred to the entire UX:3 chip family. These chips can be found in all blue and white LEDs. The LEDs are used in an extremely wide range of applications – the Osram Oslon Square, for example, in street lighting and industrial lighting. “The reduction in forward voltage was achieved thanks to a new process in the epitaxy”, said Dr. Marcus Eichfelder, Project Manager at the Regensburg high-tech company. Production of the first optimized chips started back in August 2014.

The next steps: transfer to production

There is still enormous potential. “In the laboratory we have already succeeded in further reducing the forward voltage by as much as 30 mV”, said Dr. Joachim Hertkorn,

Epitaxy expert at Osram Opto Semiconductors. This would improve the efficiency of the LED chips by a further percentage point. “In view of the speed with which this first step has been implemented, we are confident that the improved process can be transferred to production by the summer of 2015”, added Hertkorn. “Any further reductions in forward voltage will then only be marginal owing to the laws of physics.” ■

Novel LEDs by Band-Structure Engineering in van der Waals Heterostructures

Semi-transparent, flexible electronics are no longer just science-fiction thanks to graphene’s unique properties, University of Manchester researchers have found. Published in the scientific journal, Nature Materials, University of Manchester and University of Sheffield researchers show that new 2D ‘designer materials’ can be produced to create flexible, see-through and more efficient electronic devices including semi-transparent LEDs.

The team, led by Nobel Laureate Sir Kostya Novoselov, made the breakthrough by creating LEDs which were engineered on an atomic level. The new research shows that graphene and related 2D materials could be utilized to create light emitting devices for the next-generation of mobile phones, tablets and televisions and other devices to make them incredibly thin, flexible, durable and even semi-transparent.

The LED device was constructed by combining different 2D crystals and emits light from across its whole surface. Being so thin, at only 10-40 atoms thick, these new components can form the basis for the first generation of semi-transparent smart devices.

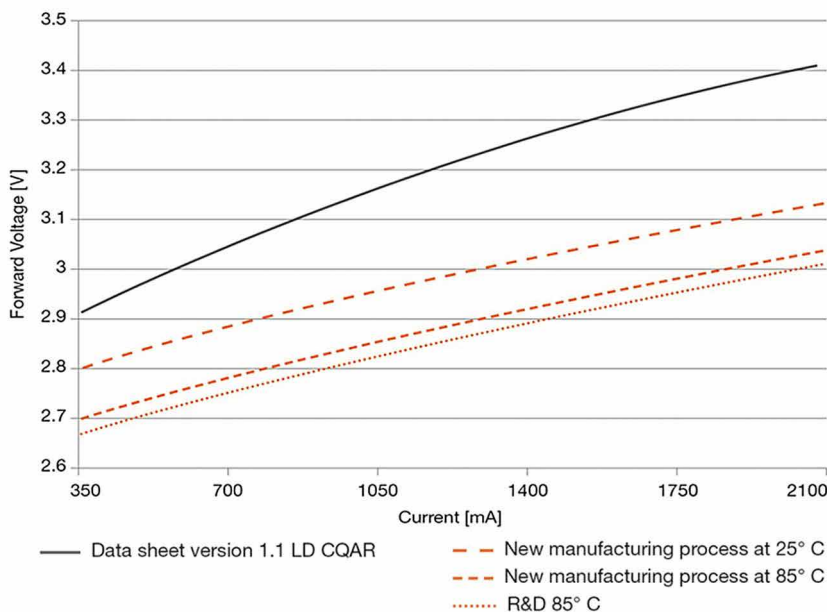

Osram experts have significantly reduced the value of the forward voltage, compared with the data sheet for the previous Osram Oslon Square



New ICL5101 High-Voltage Resonant Controller IC for LED Drivers

The ICL5101 integrates a half-bridge controller with a PFC stage for efficient and compact professional lighting. The PFC stage supports stable operation at low load conditions and the LLC half-bridge resonant stage provides gate drive function for MOSFETs rated up to 650 V. The high level of integration leads to smaller form factors with more reliable designs, less complex PCB layouts and reduced costs. All operation parameters are adjustable with simple resistors allowing simple configuration.



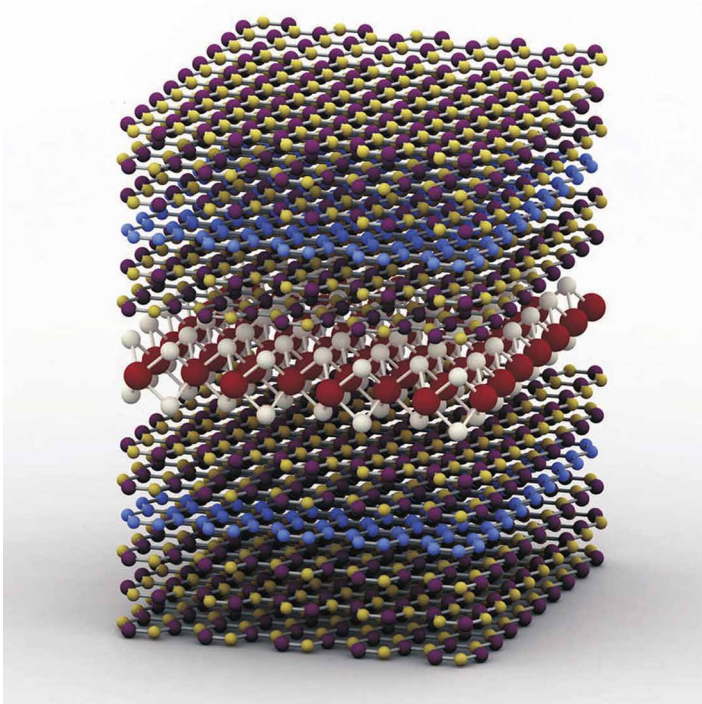

Schematic of the SQW heterostructure for graphene based, band-structure engineered LEDs

By building heterostructures - stacked layers of various 2D materials - to create bespoke functionality and introducing quantum wells to control the movement of electrons, new possibilities for graphene based optoelectronics have now been realized.

Freddie Withers, Royal Academy of Engineering Research Fellow at The University of Manchester, who led the production of the devices, said: "As our new type of LED's only consist of a few atomic layers of 2D materials they are flexible and transparent. We envisage a new generation of optoelectronic devices to stem from this work, from simple transparent lighting and lasers and to more complex applications."

Explaining the creation of the LED device, Sir Kostya Novoselov said: "By preparing the heterostructures on elastic and transparent substrates, we show that they can provide the basis for flexible and semi-transparent electronics."

"The range of functionalities for the demonstrated heterostructures is expected to grow further on increasing the number of available 2D crystals and improving their electronic quality."

Prof Alexander Tartakovskii, from The University of Sheffield added: "The novel LED structures are robust and show no significant change in performance over many weeks of measurements."

Despite the early days in the raw materials manufacture, the quantum efficiency (photons emitted per electron injected) is already comparable to organic LEDs.

The paper Light-emitting diodes by band-structure engineering in van der Waals heterostructures by F.Withers, O. Del Pozo-Zamudio, A. Mishchenko, A. P. Rooney, A. Gholinia, K.Watanabe, T. Taniguchi, S. J. Haigh, A. K. Geim, A. I. Tartakovskii and K. S. Novoselov appears in Nature Materials. ■

EdiLex AC Module Series

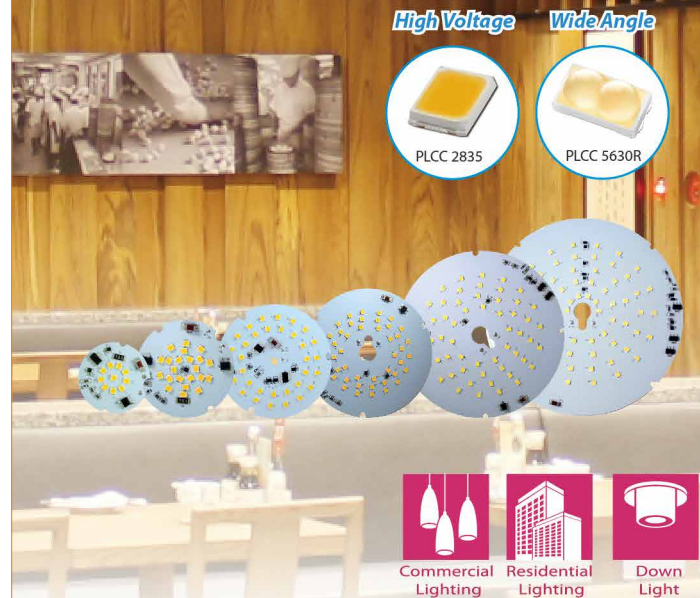

Features :

- *Connects directly to AC line voltage*
- *High Power Efficiency & Factor*
- *3-Step MacAdam*
- *CRI 90 Available*

2015 LIGHTFAIR International

05-07 May 2015

Visit us at Booth 2747



Visit us at www.edison-opto.com

The Future of More Efficient LEDs and Lasers Probably Starts in 2D

The future of electronics could lie in a material from its past, as researchers from The Ohio State University work to turn germanium - the material of 1940s transistors - into a potential replacement for silicon.

At the American Association for the Advancement of Science meeting, assistant professor of chemistry Joshua Goldberger reported progress in developing a form of germanium called germanane.

In 2013, Goldberger's lab at Ohio State became the first to succeed at creating one-atom-thick sheet of germanane - a sheet so thin, it can be thought of as two-dimensional. Since then, he and his team have been tinkering with the atomic bonds across the top and bottom of the sheet, and creating hybrid versions of the material that incorporate other atoms such as tin.

The goal is to make a material that not only transmits electrons 10 times faster than silicon, but is also better at absorbing and emitting light - a key feature for the advancement of efficient LEDs and lasers.

"We've found that by tuning the nature of these bonds, we can tune the electronic structure of the material. We can increase or decrease the energy it absorbs," Goldberger

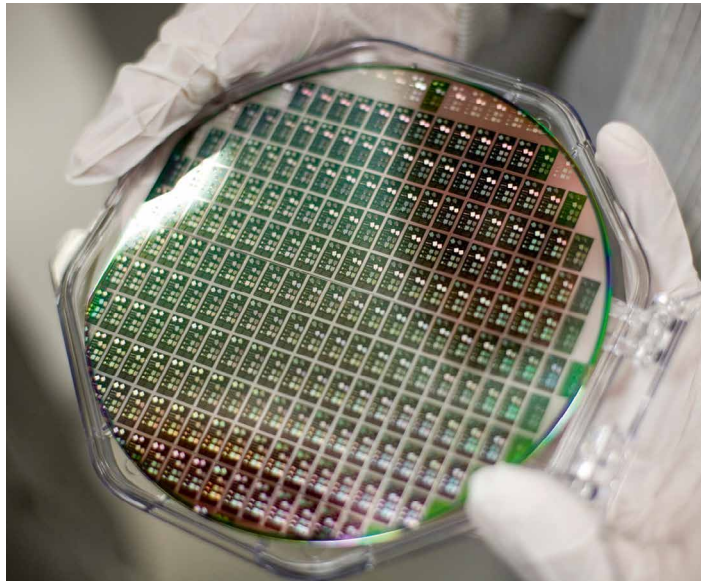

Researchers at the Ohio State University have developed a technique for making one-atom-thick sheets of germanium for eventual use in advanced electronics. In 2010, MIT's Material Research Group already demonstrated the first germanium laser (Photo: Dominick Reuter/MIT)

said. "So potentially we could make a material that traverses the entire electromagnetic spectrum, or absorbs different colors, depending on those bonds."

As they create the various forms of germanane, the researchers are trying to exploit traditional silicon manufacturing methods as much as possible, to make any advancements easily adoptable by industry.

"Aside from these traditional semiconductor applications, there have been numerous predictions that a tin version of the material could conduct electricity with 100% efficiency at room temperature. The heavier tin atom allows the material to become a 2D

"topological insulator," which conducts electricity only at its edges," Goldberger explained. "Such a material is predicted to occur only with specific bonds across the top and bottom surface, such as a hydroxide bond."

Goldberger's lab has verified that this theoretical material can be chemically stable. His lab has created germanane with up to 9 percent tin atoms incorporated, and shown that tin atoms have strong preference to bond to hydroxide above and below the sheet. His group is currently developing routes towards preparing the pure tin 2D derivatives. ■

WEBINARS

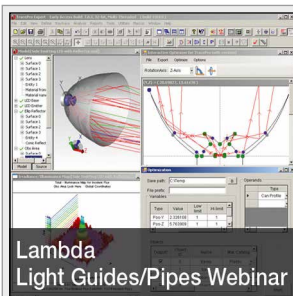

Designing & Optimizing Light Guides/Pipes - Tips & Tricks for a Streamlined Process

The Light Guide Design and Optimization webinar will teach viewers how to enhance the efficiency and output uniformity of their design. Viewers will learn how to take advantage of Total Internal Reflection, when to use diffusers and resins, and how to use photorealistic rendering to see exact light pipe output before moving to the costly prototyping stage. There will also be a full demo of how to use 3D CAD software to virtually prototype light pipes to avoid a trial-and-error design process.

www.led-professional.com/Lambda-Webinar



How Smart Thermal Protection Provided by LED Driver ICs Helps to Extend Lifetime of LED Lighting Systems

Learn more about different ways to protect the lifetime of LED systems from very basic to quite advanced methods.

Watch our webinar!

www.led-professional.com/Infineon-Webinar





LED Lighting Taiwan

The 11th Int'l LED Lighting Exposition
www.optotaiwan.com

June 16-18, 2015

TWTC Nangang Exhibition Hall

LED Niche Applications and New Business Opportunities



A The development of new LED business patterns

The new blue ocean market for LED: UV LED, IR LED, Proof lights, jointly demonstrated in special zones



B Total Solution @ One-stop shop in "Photonics Taiwan"

Cross-industry platform, promotion and integration of energy-saving services, finding best partners in Taiwan



C Most update market trends

International forums, IOA meeting, new technical publications to disclose comprehensive market trends and new technologies

Exhibits

■ LED / OLED Light Source, Package / Module/ Engine

LED Epi Wafer / Chip, OLED Components, LED Package, LED Module / Engine, OLED Module / Engine

■ LED / OLED Lighting Fixture

Technical Lighting
 Decorative Lighting
 Accessories and Electronic Components

■ LED Applications

Backlight, Automobile, Display Board
 Traffic Signal, Projector, IrDA,
 IR / UV Lights
 Others

■ LED / OLED Materials

LED Materials, OLED Materials

■ LED / OLED Equipment

LED Equipment
 OLED Equipment



Photonics Industry & Technology
 Development Association

【Contact】 Tel : +886-2-2351-4026
 Fax : +886-2-2396-8513

David Heh (ext. 254)
 E-mail : david.heh@mail.pida.org.tw



ParagonLED Provides Dimmable Driver-on-Board CoB & SMD

ParagonLED has been devoting on developing driver-on-board CoB & SMD LED, which intake power directly, thus does not need driver. Now dimmable version is available. It is with low THD (<15%). For CoB, we have 12 W, 18 W, 24 W, 36 W, and 54 W under 120 V and 230 V for American and European market respectively. For SMD, we accept customization needs. Non-dimmable version is also available. All are in mass production. ParagonLED always strives to offer you more illuminating options!

Please contact us for detail information at sales@paragonled.com

ParagonLED®

www.paragonled.com
sales@paragonled.com



BICOM LED Lenses 3R45

Highlighted here is an Acrylic plastic lens with a frosted surface. It matches LEDs from Osram, Cree, Philips, Citizen and many more. The lens is 44 mm in diameter x 21.49 mm in height. It is made from optical grade acrylic. Efficiency is up to 92%. In addition to its outstanding performance, the cost is lower and it's easy to assemble.

Please visit www.bicomoptics.com to learn more.



Cree's New CXA2 LED Arrays Enable System Cost Savings up to 60 Percent

Cree's new CXA2 LED arrays deliver up to 33% higher efficacy in the same form factors as earlier arrays. This improvement in lumen density enables better performance and radically reduces system size and cost. The new chip-on-board (COB) LEDs allow lighting manufacturers to rapidly deliver more innovative solutions for track, downlight and outdoor lighting. With the new CXA2 LED arrays, lighting manufacturers can achieve the same or better performance with a smaller LES compared to earlier products.

For more details visit cree.com/cxa2





EPIC is an industry association that promotes the sustainable development of organizations working in the field of photonics in Europe. We foster a vibrant photonics ecosystem by maintaining a strong network and acting as a catalyst and facilitator for technological and commercial advancement. To achieve our mission, we publish market and technology reports, organize technical workshops, B2B roundtables and coordinate EU funding proposals, and more.

IYL 2015 AND DAY OF PHOTONICS: AVENUES TOWARDS GLOBAL AWARENESS OF PHOTONICS

by Carlos Lee, Director General, EPIC – European Photonics Industry Consortium

The responsibility of an association is also to promote the sector towards the general public, which is why EPIC initiated DAY OF PHOTONICS as a preparatory action leading up to the International Year of Light 2015 (IYL).

Someday the word ‘photonics’ will be as common as ‘electronics’. People recognize the important role of electronics in our society and in today’s world. The DAY OF PHOTONICS aims to accelerate



Day of Photonics celebrated at the Australian National University in Canberra

the process of global photonics appreciation. The first edition of this biennial event took place in 2014 with 130 companies, universities, and organizations in 30 countries reaching out to their communities and raising awareness about photonics and its importance. They opened their doors to the public, invited journalists and families to visit facilities and encouraged staff to make presentations at schools to promote photonics.

International Year of Light 2015 is a most unique and important initiative because of its global scope and because it involves people from various sectors: non-profit organizations, scientific societies, academic and research institutions, and private companies from all over the world. Every country in the UN community has been tasked to take part and reach out to the public and most have responded positively. For instance, Israel has issued a stamp commemorating IYL 2015! Technologies have no borders and photonics companies are found everywhere in the world, so it makes sense to have a global initiative which has a very strong, local, regional and national aspect – and this is what IYL offers.

In order to show the multidisciplinary character of the year, Epic plans on collaborating in specific events with international student organizations with which we are connected through the Informal Forum of International Student Organizations (IFISO).

EPIC is a “Gold Associate Sponsor” of IYL because when people understand photonics, they will press politicians to support the industry. Government aid, will, in turn, spur investments and more parents will likely support children interested in pursuing studies in photonics-related courses. With more young and bright minds involved in photonics, new ideas and innovations will constantly be produced, making the whole industry ecosystem even more dynamic and vibrant! Both IYL2015 and DAY OF PHOTONICS are important because they complement each other in many ways, and learnings can be shared from both initiatives. This year, however, all attention and support from the photonics industry should be directed towards the International Year of Light - so become engaged and start by reviewing the latest updates on www.light2015.org. ■

C.L.

GAME CHANGING IS GREAT.

BOTTOM LINE CHANGING IS BETTER.

NEW CREE® XLAMP® LEDs CAN
IMPROVE RELIABILITY
REDUCE SYSTEM COST
REDEFINE LED LIGHTING

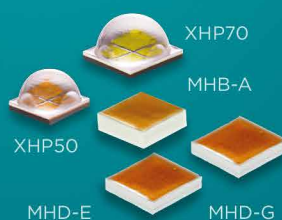

You can't change your bottom line by using the same LEDs that everyone else is using. Cree's Extreme High Power (XHP) LEDs deliver double the lumen output at high operating temperatures, while our MH LEDs combine the system advantages of our best arrays with the manufacturing ease of a discrete. And our CXA2 LED arrays are packed with lumens to offer system cost savings up to 60%.

See how higher power equals lower cost. cree.com/xhp
The new way to a better LED array. cree.com/mh
Save up to 60%. cree.com/cxa2

CREE 

Let there be Light - A Brief Overview of the Meaning of Light

The inauguration of The International Year of Light at the UNESCO headquarters in Paris brought to mind that, despite its importance, LED lighting only represents a small fraction of the photonics world. All of the many light based technologies are included in The Year of Light. Arno Grabher-Meyer from LED professional attended the opening ceremony and talks about the journey he made there through lighting history, space, culture and inventions.

Ancient cultures may only have been subconsciously aware of the relevance of light in connection to life, especially for humans.

As the early religions formed so did prehistoric man start comparing their god(s) to light. Later, the idea that God is light became the belief for the

world's major religions. The idea of bringing light to the world is of great importance to nearly all natural and world religions.

Rekindling the idea that light is necessary for our lives and cultures is one of the most important aspects of the Year of Light. The inauguration

ceremony demonstrated this idea by touching on scientific, religious, political, cultural, artistic, humanistic, economic and ecological viewpoints. The contributions were of great interest, even for those of us whose professional lives only revolve around LED lighting.

Inauguration ceremony
in the plenary hall of the
UNESCO

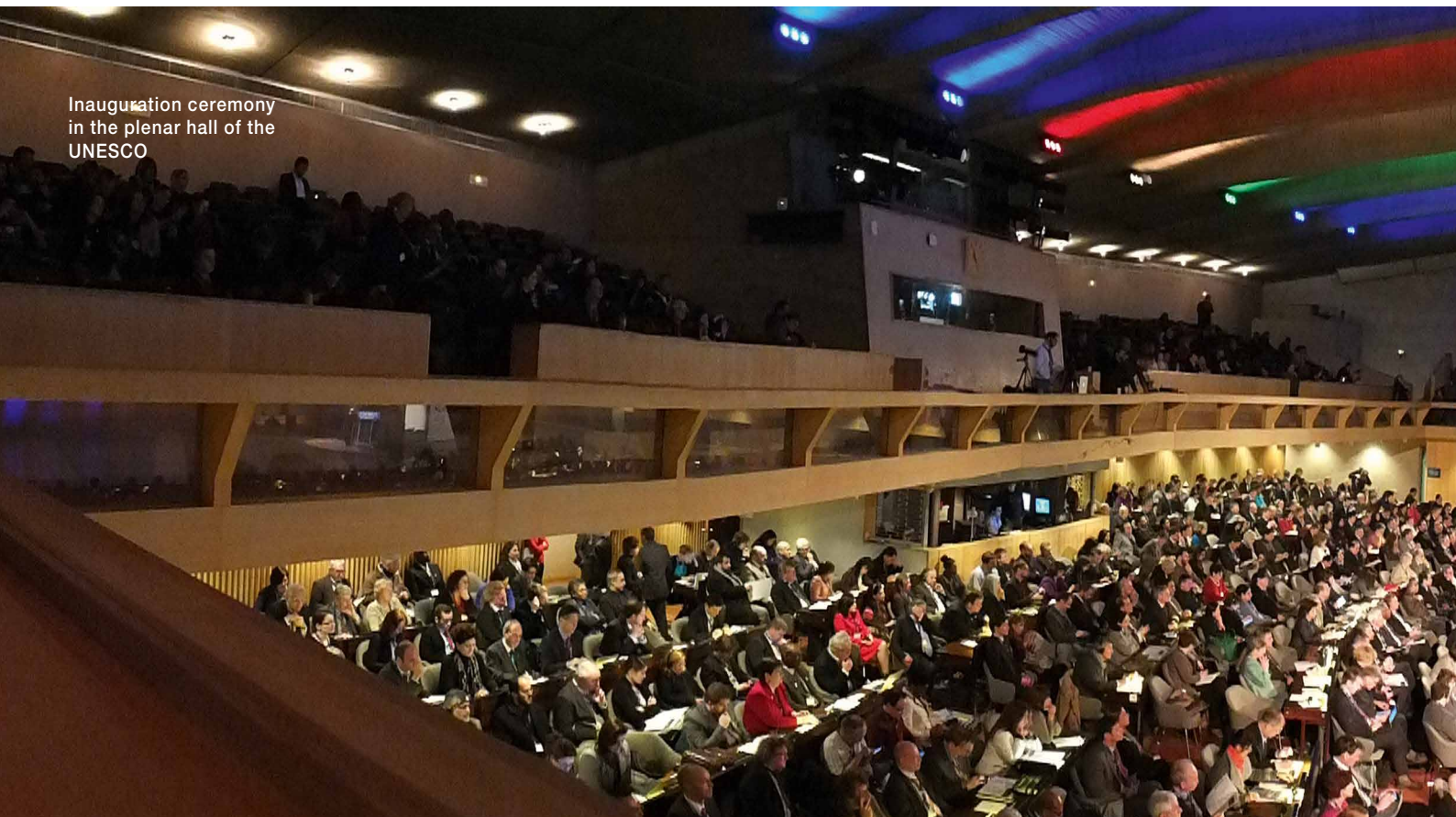

After the welcome speech made by the Secretary General of the United Nations, Ban Ki Moon, Irina Bokova, Director General of UNESCO and Flavia Schlegel, Assistant Director General for Natural Science at UNESCO made their speeches. They were followed by dignitaries from some of the initiating states and organizations who also addressed the audience. The program continued to impress the guests with “Nobel Plenary Lectures” held by Nobel Prize winners in the fields of photonics and “Thematic Sessions” where experts shared their opinions on the given topics.

There were also several artistic performances, movies, presentations of planned activities, and a cocktail party. To complete the event that evening, the outside of the UNESCO building was imaginatively illuminated.

Nobel Laureate's Plenary Lectures

Nobel Laureate Ahmed Zewail chose the topic of “Light and Life” [1] where he showed different biological processes that are based on light.



Ahmed Zewail was the first of the Nobel laureates to speak. He made the audience familiar with the history of lighting science, future challenges and opportunities, and his understanding of a better world

He emphasized that the process of photosynthesis, probably the most important process for life, has not been able to be replicated despite the huge amount of money invested in research. He also conveyed how impressed he is by the highly efficient biological process that allows us to see and pointed out that without light there wouldn't be any vitamin D synthesis. And without vitamin D we wouldn't be able to survive. In addition, Ahmed Zewail also gave an historical account of optical science from the early days up until today. He talked about the life of Ibn al Haytham (965 - 1039 A.D.), also known as

Alhazen, who has been credited as being the founder of modern optical science and is a central figure of one of the remarkable campaigns for the Year of Light. Ibn al Haytham was the first to understand and describe the basics of vision correctly. He invented the Camera Obscura, which is still the basis of today's photo and video cameras. Mr. Zewail applauded Galileo, Newton, Fresnel, Young, Maxwell, as well as Einstein, Planck, and de Broglie for describing the nature of light. He also acknowledged the relevance of coherent light, known as laser light, that has allowed for many new developments

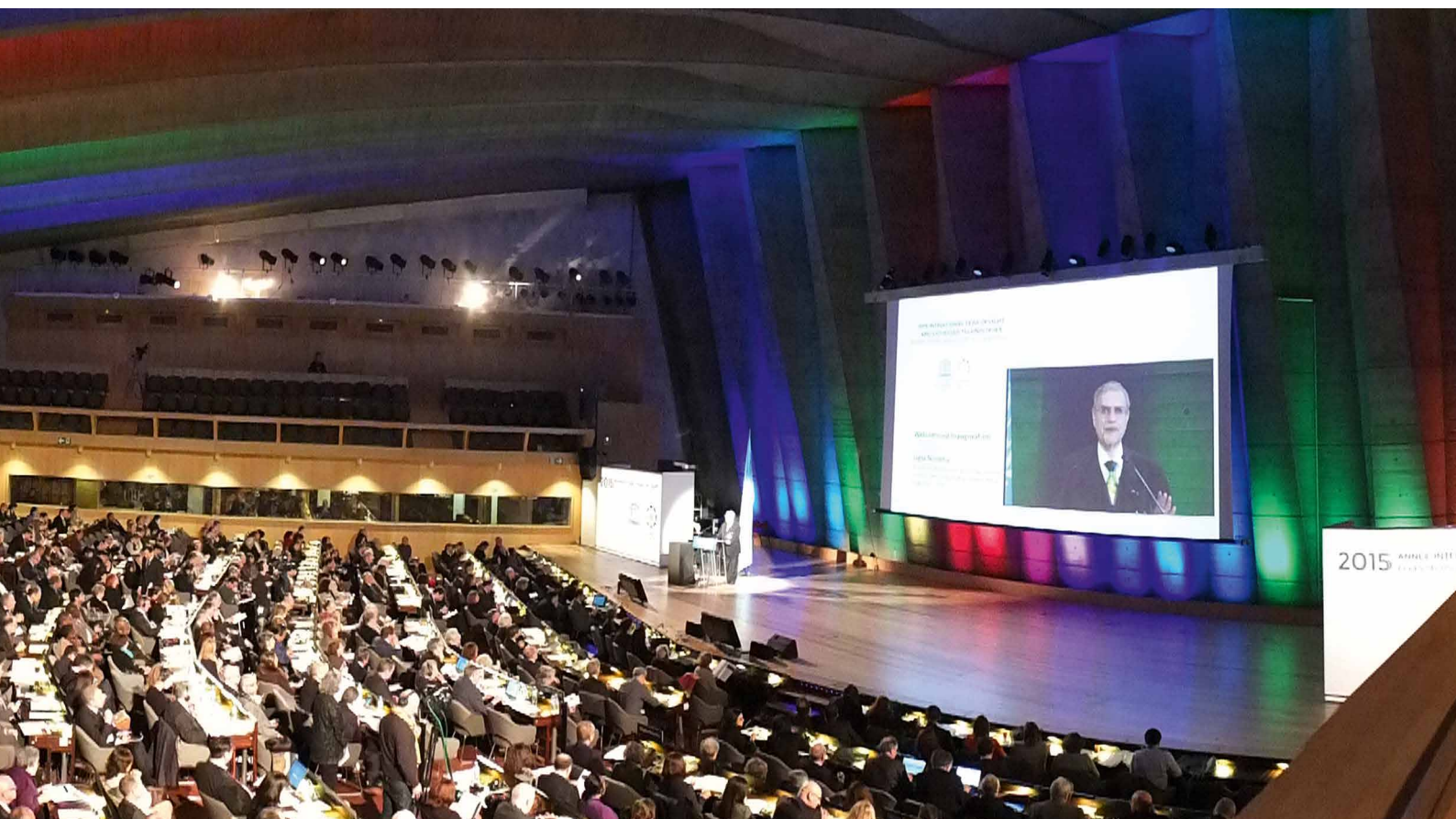

Nobel laureate, Steven Chu, emphasized that climate changes are made by man. He described how photonics can contribute towards environmental protection



like trapping and cooling atoms, optical communications and quantum physics. Finally, he introduced his own research of Femtochemistry and Femtobiology where his team not only wanted to understand molecular processes in time, but also in space. One of the tools needed to do that is the electron microscope. This had to be developed into a so-called ultrafast 4D electron microscope. This microscope allows movies to be taken of moving objects on the nm scale. These films can be used in many research areas to help clarify the mechanisms of diseases like Alzheimer's and possibly to defeat it. And everything is light based. Mr. Zewail also raised the topic of "Light and the Future of Civilization". Here he mentioned challenges and showed examples in medicine and biology, alternative clean energy, global warming, water, food and population, nano-machines and molecular control, information technology and space exploration. Finally, he pointed out that the driving power for science is curiosity. Ahmed Zewail closed his lecture with a plea for a better AAA world. The three A's stand for alleviating the "Not Knowing", alleviating the

"Not Having", and alleviating the "Not Free", by providing education and science, aid on a partnership basis, and liberty and justice.

Steven Chu, who shares the Nobel Prize for Physics and awarded for laser cooling and the trapping of atoms, talked about "Energy and Climate Change: Challenges and Opportunities" [2]. He started his speech with the philosophical statement that the words 'vision' and 'insight' go well beyond the sensory input. Honoring Maxwell's achievements he gave a brief overview of the frequencies that are used and known today. He produced clear evidence of the climate change from the rise of global average temperatures to the increased worldwide weather related losses of insurance companies. He explained that measuring the current and projected rise of the sea level and the shrinkage of glaciers is based on photonics. Environmental issues included the example of particulate matter less than 2.5 microns, which are known to increase the risk of lung cancer by 36% per $10 \mu\text{g}/\text{m}^3$. While the current annual EPA average limit already allows $12 \mu\text{g}/\text{m}^3$ (WHO 50), in some areas,

such as Beijing, the average concentration is $194 \mu\text{g}/\text{m}^3$, which is significantly higher than in a room full of smokers. Your chances of getting lung cancer in Beijing are 27 times higher! Mr. Chu also showed that generating electricity using alternative energy technologies is cheaper than conventional energy generation. Real contracts for wind power purchase are based on approximately \$0.03 (US) per kWh, whereas a new natural gas based contract is approximately \$0.05 (US) per kWh. Similarly, he showed that photovoltaic-based electricity is on a par with natural gas based contracts. He demonstrated that there is a huge demand for off grid photovoltaic solutions using batteries and that the cost of batteries is crucial. In the last part of his lecture he talked about light and some of the latest achievements like improved light measurement and increased sensitivity and resolution. Here he mentioned the development of algorithms that increase the resolution of optical microscopes by determining the centers of the blurred light points. He also showed an example of rare, earth-based nanoparticles developed by his team, that have



The Nobel Prize winner for Physics 1997, William D. Phillips, used - as he said - “the coldest stuff you’ve ever seen”, liquid nitrogen, to demonstrate what the advances in photonics mean for laser cooling technologies and subsequently for practical applications

several advantages over known quantum dots, being brighter and more stable. These molecules emit in a wavelength where tissues are transparent and could be used in different medical diagnostics applications. Another fascinating optical mathematical method for optical microscopy, called structured illumination, does not increase resolution much, but gives a 3D image of the observed object.

William D. Phillips, the 1997 Nobel Prize winner for Physics, had an action-packed presentation titled “Einstein, Time and Light” - a revolution resulting from Einstein’s $E = m \cdot c^2$. Schools and universities use liquid nitrogen for experiments, and using it as well, Prof Phillips showed what the race for lowering temperatures closer and closer to absolute zero means. The boiling point of liquid nitrogen is -196°C or 77 K and this, as Mr. Phillips said, “is the coldest stuff you’ve ever seen”, but it is far from the temperature that researchers are trying to achieve. In 1995, the lowest temperature record was set at $1\ \mu\text{K}$. Since this breakthrough, many groups throughout the world routinely reach nK temperatures with a reported lowest temperature

of $3\ \text{nK}$ in 2002. In 2003 the record was broken and a new record of $500\ \text{pK}$ was set. This resulted in highly improved accuracy of the atomic clocks from a $1 \cdot 10^{-16}$, which means that the clock is accurate to within one second in 300 million years, to $2.4 \cdot 10^{-18}$, which equals an accuracy of one second to 13.7 billion years, which is the age of the universe. If you’re wondering if this is of practical importance, the answer is yes. Because of this, the accuracy of GPS measurement and the satellite-based measurement of sea levels and other altitudes has increased from meters to a few centimeters. Why was this a relevant part of the Year of Light opening? Quite simply, the technology was only made possible by using light in the form of laser based cooling. Mr. Phillips concluded with a list of what this technology could be used for in the future in regards to light and cold matters. He mentioned better clocks, cold chemistry, tests of the fundamental understanding of nature, quantum information, quantum computer research, and quantum simulation. He also said, “Perhaps the IYL will inspire young people to think of even more exciting ideas.”

His closing statement was, “We are coming to the end. But it is not the end, it is just the beginning.”

“Light and the Quantum”, the title of Serge Haroche’s lecture, sounded as if only Nobel laureates would be able to understand it but Prof. Haroche made it easy for everyone to comprehend. He demonstrated quantum physics based on three questions about the nature of light at the beginning of the 20th century: Why does the spectral distribution of a heated body follow a bell-shaped curve? Why is there a threshold for the photoelectric effect? Where do the discrete lines in absorbed or emitted light come from? The answers opened the way to the world of microscopic atoms and photons and led to today’s quantum physics that finally gave the keys to modern technologies. Using Schrödinger’s Cat thought experiment, he illustrated how quantum physics are challenging our common understanding. He emphasized that the strange behavior of quantum physics holds the key for new technologies for communication and computing. He explained that light extends far beyond the visible range

The wave-particle dualism of light, here perfectly interpreted by the artist D. Hofstadter, is the basis of quantum physics and was a core concept of Prof. Haroche's lecture



(radio waves, x-rays, etc.) and went on to talk about the findings that led to this new world of exciting new applications like ultra-deep cooling and MRI. Basically, it was Einstein's finding that light waves are quantized photons, Bohr's finding that there are quantized electronic orbits and de Broglie's theory that electrons have wave properties. The quantitative formulations of these findings by Heisenberg, Schrödinger and Dirac in the mid 1920's finally opened the door to today's physics. Prof. Haroche showed the strangeness of quantum physics when he explained that sending photons one at a time through a double-slit leads to the same interference pattern as the classical double-slit experiment. He also made the basics of the complex superposition and entanglement topics understandable in his illustrative speech. He demonstrated the influence of the environment on experiments and showed why the classical world observations don't show the strangeness of the "quantum world". Prof. Haroche pointed out that tunable lasers, today's fast computers and superconducting materials are direct results of the understanding of quantum theory. Leading up to "Schrödinger's Cat" and uncertainties, he spoke briefly about his own research,

Cavity Quantum Electrodynamics, which aims to explain interactions between matter and light on a very fundamental level. Then he asked the question "why is this basic research important?" The simple answer is: Wanting to understand how nature behaves on a certain level. This understanding finally leads to new and modern technologies and applications; applications that often even exceed the imagination of the researcher who did the basic work and the inventor of the resulting new technology.

Prof. Zhores Alferov led the audience through the world of "Efficient Light Conversion and Generation" [5], by citing George Porter from the Royal English Society of Science who said, "Science is always applied science; don't divide between basics and applications. The only difference is that some applications appear immediately, while others need time." Prof. Alferov started with explaining about research on nuclear energy and weapons, namely the hydrogen bomb, "which is basically a simulation of the sun on earth" based on nuclear fusion. Despite being skeptical, he is convinced that if there is a solution for the commercial use of nuclear fusion for power generation to become reality, laser technology will play the key role. After his

introduction he concentrated on solid-state lighting, giving an historic overview, starting with Oleg Losev who discovered visible light in a silicon-carbide point contact diode for the first time in 1923 - the first LED. Prof. Alferov continued with an introduction to semiconductor heterostructures, and super lattices, necessary for solid-state lasers and LEDs, and the Nobel Prize laureates in the related research fields. While being important for opening the way to fast fiber optical telecommunications via laser diodes and LEDs that can work at room temperature, heterostructures are also relevant for other applications like solar cells. Prof. Alferov pointed out the corner stones of the development of modern LEDs, mentioning the first pn-junction laser and LED development. He commended the academic achievements of Isamu Akasaki, Hiroshi Amano, and Shuji Nakamura for inventing the blue, light emitting diodes. One slide and side-note were used to give a short overview of a color tunable monolithic multi-color heterostructure LED as a next step leading to phosphor converted LEDs. Besides the commonly known figures on energy saving and market penetration, he showed some very interesting facts about the Chinese goals of targeting 70% SSL penetration in 2020. This would cause an energy savings of 340B kWh/year - which equals four times the production of the Three Gorges hydroelectric power plant on the Yangtze River in China. He also compared the potential of heterostructure based silicon solar cells, especially in multi-junction configurations, with GaAs/GaNP solar cells. Finally, he referred to the lecture of Prof. Chu, when he showed the prediction for energy sources in 2013 and said: "While it is always hard to make a prediction, solar energy conversion made by photovoltaic semiconductor materials will definitely be one of the main energy sources. And semiconductor lasers and LEDs will be the main light sources for many applications."



John Dudley (left) and Joseph J. Niemela (right), two of the coordinators and initiators of the IYL, led a good number of the thematic sessions

Short Overview on the Thematic Sessions

The thematic sessions were segmented into “The International Community of Light and Light-Based Technology”, “Lighting the Future”, “Light for Humanity and Culture”, “Light on Development”, “Light at the Limits”, “The Future of Light” also called “Science Frontiers”, “Light Solutions” and “Science Policy”. More than 35 powerful speakers from different disciplines and countries presented their views on these topics. An overview of all of the lectures

would exceed the objectives of this article; therefore just a handful of exemplary statements and an overall summary for each session shall be covered here.

There was one unmistakable major message in “The International Community of Light and Light-Based Technology” session which dealt with context, challenges and opportunities in 2015 for the lighting community: Affordable lighting for the underprivileged is essential, especially in emerging countries.

This is seen to be the key for reducing poverty for several reasons: Firstly, LED lighting in combination with photovoltaics helps people to save money. It provides light in the evening and nighttime with no additional costs. Secondly, it allows children and students to learn in the evenings and thereby improve education in these countries. Thirdly, it helps to improve health and saves the environment because no kerosene or candles need to be burned in the quarters that release toxic fumes. In addition, the need



Speakers from very different regions and disciplines held talks demonstrating their commitment to the IYL. Just to name a few (from top left to bottom right): Charles Falco from the University Arizona, Danielle Harper representing the Int. Association of Physics Students, Alain Aspect - UNESCO Niels Bohr Medal Laureate, Sune Svanberg - former chair of the Nobel Committee for Physics, Eric Rondolato representing Royal Philips as CEO of the lighting sector, and Yanne Koumou Chembo from the African Physical Society

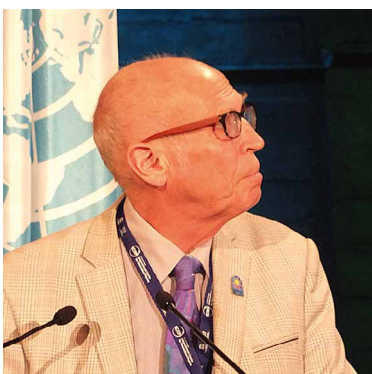

for a better cooperation with emerging countries was addressed. In this sense, Francis Allotey from Ghana said, “Africa missed several technical advances and trends but must not miss the photonics revolution.”

The session “Lighting the Future” also addressed the topic of lighting for the poor as well as other aspects like safety, lighting of cultural heritage sites, lighting for improved quality of life or energy waste and light pollution. The contributors approached these topics from different sides, taking philosophic, pragmatic and exemplary views. The theme running through these speeches was that lighting the future means developing innovative solutions that keep in mind the various aspects presented and providing light to improve the quality of life.

“Lighting for Humanity and Culture” covered lectures of a very different character. The tremendous significance of light in different cultures and for civilization was impressively demonstrated. For instance, Gianfranco Cardinal Ravasi gave an overview of what light means in religions and how it is interpreted. Light is not just a medium that passes knowledge and tradition from generation to generation, it is also relevant for art, art history and art science. For example, an artwork can be perceived differently depending on the light used. In addition, using imaging technologies with different lighting can make invisible layers

of paintings and artworks visible. The cultural importance is also marked by the fact that all the known geniuses devoted themselves to light. Probably the most outstanding person in this context was Ibn Al-Haytham whose findings and life were impressively reviewed by Charles Falco.

The thematic sessions of the second day started with the topic “Light on Development”. In a mixture of lectures representing the broad view of this issue, lectures were held presenting the status and impact of optics and photonics research in Africa, as well as the impact of lasers as medical instruments on societies by the example of the lives of vulnerable communities in Vietnam. Sudhanshu Sarronwala from the WWF in Singapore closed the session with his report on the history and status of the Earth Hour campaign by demonstrating the power of light as a vehicle to point the way.

“Light at the Limits” was the very apt title for the lectures that followed. The speakers gave an impressive demonstration of how studying the properties of light have led to breakthroughs in our understanding of the physical world. They showed how limits were pushed further and further. The results have proved to not just be relevant for optical science, but also for new advances and understanding in fundamental physics and multidisciplinary applications.

The subsequent sessions “The Future of Light” and “Science Frontiers” took up the thread by following the application path. Alain Aspect from the Institut d’Optique did a thorough review on how and which basic research has yielded important applications in many different areas of science and technology. Bernard Kress from Google C-Labs provided an overview about their projects and developments that are based on photonics technologies and research, and how they think these applications could ease and improve people’s quality of life, especially in remote areas. Ways to fight diseases with biophotonics was the topic of Brian Wilson from the University Health Network Biophotonics, while Sune Svanberg, former Chair of the Nobel Committee for Physics introduced the audience to the history and principles of the Nobel Prize and the success story of light being recognized numerous times for this highest scientific award.

The journey into “Light Solutions” once again led the audience through emerging countries. While Illac Diaz from the “Liter of Light” and “My Shelter Foundation” demonstrated a simple DIY solution for bringing light to houses in tropical regions without heating them up, Martin Aufmuth from “The OneDollarGlasses Association” showed a business model that provides affordable glasses to ametropic people in emerging countries while giving local individuals a business perspective.

The last program point before the official closing was a panel discussion about science policies with former and active ministers for science and technology, university members, and board members of the EC and UNESCO





Impressive artistic performances and artworks were presented to demonstrate the importance of light in different human cultures and ages. The spectacular showcase of "From Darkness to the World of Light" by the Ngati Ranana London Maori Club visualized the struggles of bringing light to the world. The film, "Einstein's Light" from Nicolas Barris with the music composed by Bruce Adolphe and divinely interpreted by Joshua Bell on a Stradevari, accompanied by Marija Stroke on the Piano, honored Einstein's contribution to today's modern world.

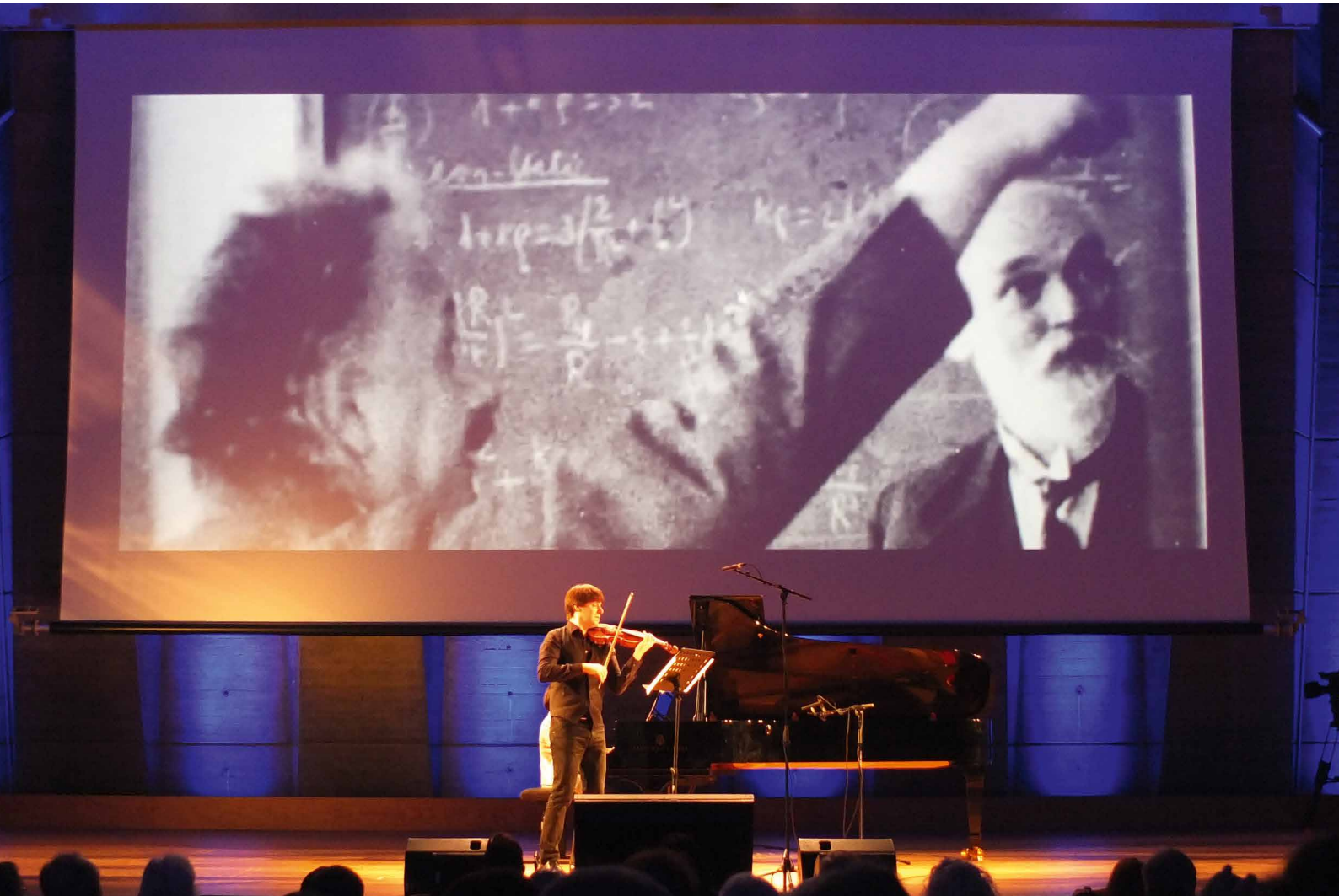

A similar idea to provide affordable solar lights was proposed by Linda Wamune, representing “Sunny Money” and “Solar Aid”, from Kenya.

The last session before the closing remarks was held as a round table discussion under the title of “Science Policy”. The participants were in agreement when they stated that the fruits of science have to have a long-lasting impact on society, but at the same time emphasized that to facilitate this, many issues and topics have to be addressed and some problems need to be solved. With their different backgrounds, they recognized that the North-South cooperation needs to be improved by promoting education in science and engineering as well as driving innovation and economic growth. They also agreed that a good portion of civic engagement will be necessary. Naledi Pandor, Minister of Science and Technology of South Africa reminded the audience that emerging countries and their research institutes, even if they have the prerequisite capabilities and resources, are not recognized as possible partners in projects. She also pleaded for a kind of emancipation of emerging countries, Africa, in particular.

Supporting Program and Artistic and Cultural Acts

Different session topics of the first day were not just addressed by lectures, but also visualized with artistic performances, exhibits and installations. With the 1001 Inventions and the World of Ibn Al-Haytham Campaign, the life of this outstanding scientist, inventor, architect and artist was honored and the world of photonics presented. Al-Haytham, who published his “Book of Optics”

in 1015, is recognized as the father of optics. He invented the camera obscura, which is still the basis of today’s cameras.

The performance “From Darkness to the World of Light” by the Ngāti Rānana London Maori Club, visualized the genesis from emptiness to the existing world: At the beginning, the earth and the skies came into being through the self-generation of Ranginui, sky father, and Papatuanuku, earth mother. Ranginui and Papatuanuku prevented light from reaching the world because of their close embrace, and their offspring lived in a world of darkness and ignorance between the bodies of their parents. They plotted against their parents in order to let light into the world. It is said that some of the sons decided that their situation could be remedied only if they separated their parents, so that Ranginui would be pushed up to become the sky and Papatuanuku would remain as their Earth. When they set about their task, it was Tane who finally got them apart by resting his shoulders on Papatuanuku and thrusting his legs upwards and pushing Ranginui to the sky. By this separation of Rangi and Papa the world of light, of existence, the third state of creation, came into being. The impressive rendering of this myth demonstrated the global and universal relevance of light across different cultures.

Equally impressive was “Einstein’s Light”, impressions of images and music. The tripartite film, “Einstein’s Light”, from Nicolas Barris and Imaginary Films was a fantastic arrangement of film sequences, images, documents, and artworks from and around Einstein’s life and work. Joshua Bell, accompanied

by Marija Stroke on the Piano, delighted the audience with his divine interpretations of Bruce Adolphe’s compositions on a Stradivari. His three compositions for the film; “Light, Speed, Grace”, “Einstein’s Sarabande - The Loneliness of Genius and the Guidance of Light”, as well as “Innovation - From Mozart, War, to Flash of Scientific Insight” were inspired by the importance of light.

The Reception Cocktails were served in the Salle des Pas Perdus of the “Light is Here” illuminated UNESCO building. The evening ended in a relaxed atmosphere that invited the guests to experience the exhibition. The opportunity to communicate and to come to know each other better was taken advantage of by most of the visitors. The outside illumination was designed and implemented by the Finnish artist Kari Kola who transformed the facade of the building into the Aurora Borealis.

Closing Remarks

The opening ceremony for the International Year of Light and Light Based Technologies in Paris was a brilliant start. It opened everybody’s eyes to the different meanings of light. Even though it was a festive event, the speakers also addressed serious topics. The program covered all possible aspects of light from fundamental scientific research to applications, art, culture and social and political consequences. It gave a first overview of what else can be expected from upcoming events celebrating the Year of Light 2015. It will be well worth keeping our eyes open for the numerous events around the world and attending as many as possible. ■

References:

- [1] “Light and Life”, Ahmed Zewail: <http://www.youtube.com/watch?v=FxHkAoAFGHs>
- [2] “Energy and Climate Change”, Steven Chu: <http://www.youtube.com/watch?v=P59f8x6Xgg4>
- [3] “Einstein, Time and Light”, William D. Phillips: <http://www.youtube.com/watch?v=eodXu0t78ns>
- [4] “Light and the Quantum”, Serge Haroche: http://www.youtube.com/watch?v=_7D5SIYa28g
- [5] “Efficient Light Conversion and Generation”, Zhores Alferov: <http://www.youtube.com/watch?v=BOuHWzUEUxw>



Some of the exhibits from the “1001 Inventions and the World of Ibn Al-Haytham” campaign were on display in the Segur Hall of the UNESCO building, creating an inspiring ambience for the “Evening Cocktail Reception”. Contemporary light art was presented in the exhibition area and Finnish artist, Kari Kola, re-created one of the most fascinating natural light phenomena, the Aurora Borealis, to illuminate the façade of the UNESCO building



Tech-Talks BREGENZ - Ewing Liu, Everlight, Technical Marketing Manager



Ewing Liu

Ewing Liu is the Technical Marketing Manager at Everlight Americas, Inc. After completing his education at the University of Texas he joined Everlight as a Strategic Account Manager. He is well versed with a variety of Everlight products, technologies, global market performance and trends.

LED manufacturers have different strategies and approaches for their product portfolios depending on from which business they are originated. Everlight has a very long experience in optoelectronics as packaging company. Accompanied by Christopher Keusch, Director of Lighting Business EMEA, Ewing Liu, Technical Marketing Manager at Everlight, talks about about the background of the company, the worldwide strategies and upcoming technologies.

LED professional: Could you give us some background information about Everlight?

Ewing Liu: Robert Yeh founded Everlight in 1983 to manufacture, market and sell LEDs. In 1983 we started with visible LEDs and a year later with IR LEDs, photo couplers and other products. This enabled us to be a complete optoelectronic manufacturer. We have between 5,000 and 6,000 employees worldwide and that makes us one of the largest LED manufacturers in Asia. Mr. Yeh has a background in production and is responsible for a lot of Taiwan's LED market. For example, Epistar, the largest chip manufacturer in the world, only made 4 element chips at first. When everyone started to shift towards 3 element InGaN chips Epistar didn't have the capital to buy MOCVD machines. Robert Yeh stepped up and supported Epistar in terms of creating the blue LED business. If that hadn't happened, the white LED business would be very different, right now. Mr. Yeh was on the Board of Directors of Epistar for quite some time and he's also the owner of Everlight. In 1990 Everlight was publicly traded on the Taiwan stock exchange. Since Epistar is the largest chip manufacturer in the world and we are one of their largest customers, this enables our capacity to be one of the largest in the industry as well. By the end of November 2014 we were selling 4 billion LEDs per month.

LED professional: Everlight's main business is packaging. What are the main fields of applications that you supply to and what is the approximate share for each in terms of lighting, medicine, displays and so on?

Ewing Liu: Yes, our main business is packaging and we are vertically integrated with Epistar. 75% of the chips we use come from Epistar. Our largest segment is backlighting at the moment. This includes TVs, laptops, cellphones and even navigation units. That is about 25% of our business. The next largest would be our infrared business - which is about 22% and then lighting comes in at about 13% to 15%. We also do a little bit of automotive and signage. The rest are standard commodity indication type LEDs. In 2014, Everlight was ranked 8th in the world by a market survey and showed the highest growth in the industry across all areas. Most of our growth comes from lighting.

LED professional: Cost reduction, longer lifetimes and higher efficiencies are always a topic for industry. What are the main packaging trends and challenges?

Ewing Liu: Cost is a given since everyone tries to make bigger profits so the price per component has to go down. Longer lifetimes are not necessarily true any longer for a lot of lighting products. Of course there are different segments in lighting; you have consumer products, professional lighting type products and industrial type products. You may have to maintain a high lifetime for professional and industrial products, but for consumer products reliability is not a main issue anymore. It is all about cost. For example, everyone wanted a minimum of 50,000 hours for a light bulb and this came at a certain cost but people are now dropping down to 15,000 hours, and for some specific cases they only require 8,000 hours. When you allow

lifetime to be at a certain level there is a cost advantage. You can use a different type of LED and different type of packaging material. So there is a cost lifetime trade-off depending on the market. I think for large manufacturers with billions of pieces per month, the quality level is on a set path. Unless we drastically change a chip, material or bonds there will not be a big difference in reliability.

LED professional: There is a trend, also due to cost optimization, to eliminate the package entirely and just put the dye on the substrate, directly on the heat sink. Are you also moving in this direction?

Ewing Liu: In the overall scheme of things Everlight's focus is still on components but Everlight does have a lighting fixture business. In the USA and Europe it is called Zenaro. In China it is called Everlight Solid State Lighting. So we are headed in that direction. It has to do with survival because at some point there won't be too much demand for packaging in lighting, with the exception of very low-cost products. It takes huge capital investment to be able to do chip on heat sink or chip on substrate and no one has the capacity to do it on a large scale as yet. It might not even make sense in terms of the investment into facilities and labor.

Christopher Keusch: We have developed all the packaging technology at Everlight and this is still our focus, but we have discontinued the so-called 'old packages' with high thermal impedance or high thermal resistance because they didn't provide the required efficiency. Therefore, all of the LED packages

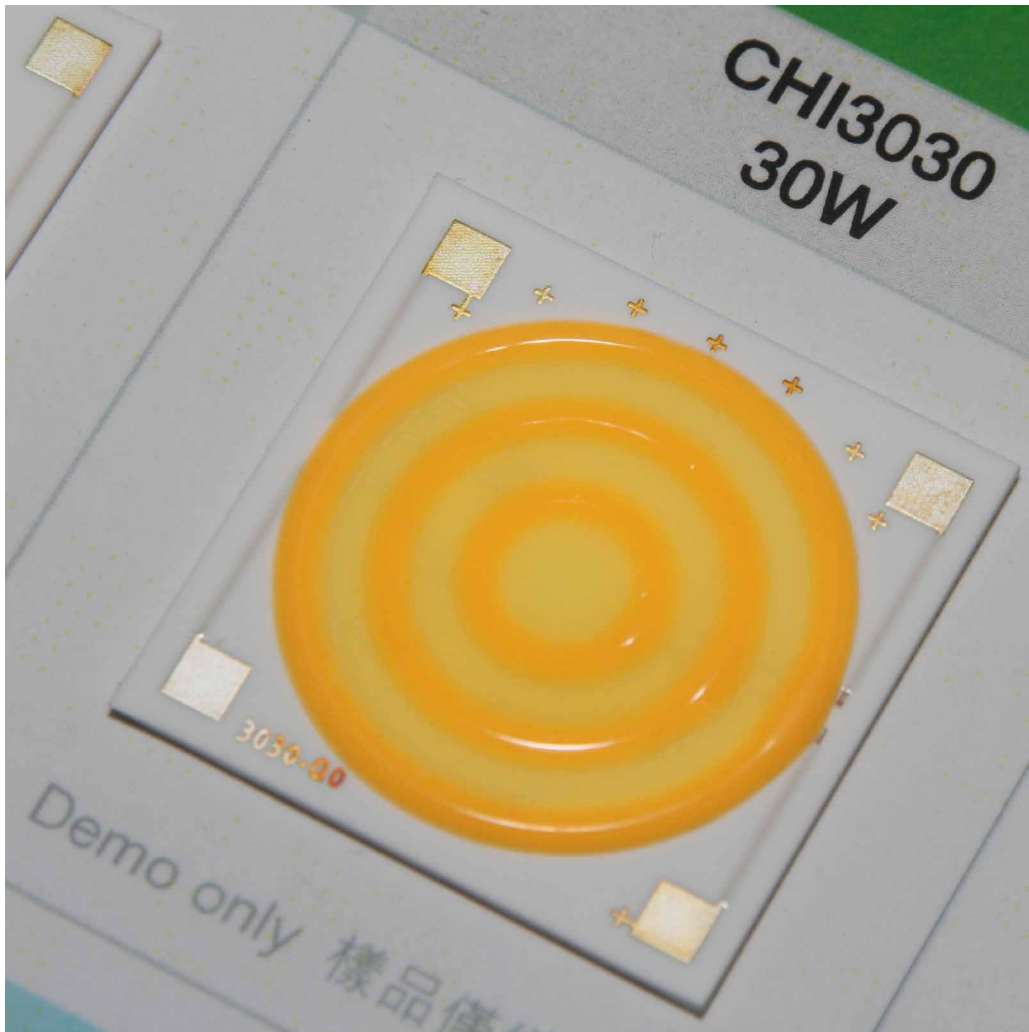

Ewing Liu brought brand new demo samples of Everlight's latest products. The Color Choice® Series makes designing CCT tunable luminaires easier

currently provided have an internal heat slug that allows the chip heat to be transferred directly to the heat sink. A metal piece located right underneath the chip allows the chip to dissipate heat directly to the heat sink. In earlier designs, heat had to travel all the way through the heat frame and this has been eliminated. We can achieve 30% to 40% better thermal resistance with this design.

LED professional: How do you decide whether to have a separate or integrated heat slug with the cathode? What are the pros and cons and are they application specific?

Ewing Liu: When you have a thermally isolated lead frame like a heat slug, the cost is slightly higher. So cost is one consideration. For many of our low to mid power components, we originally started with thermally isolated products and it still remains for a lot of higher

efficiency applications that need better thermal resistance and better thermal dissipation. If the product is more cost conscious, we switch to a newer version that is not thermally isolated and we're dissipating the heat through the anode or cathode. That's the main difference. A lot of the cost conscious products won't need thermal isolation because they can have a higher case temperature for the LED for a lower cost. Those with long lifetime, high-grade product requirements might choose the heat slug.

LED professional: Do you use single dies or multiple dies in a package?

Ewing Liu: There are many different types of combinations. Everlight has one of the largest capacities on the market so it is hard to have a single, focused product or combination for any type of LED. We are very

modular and flexible. We set some parameters but in the lighting market everybody wants something slightly different. Each application is very different so it usually depends on what the customer wants. We select a particular chip, lead frame, specific package material and phosphor to create a combination that works for the customer. The lighting industry moves too fast for us to have one set LED with a very clear family line.

LED professional: How big do the volumes have to be for customization?

Ewing Liu: It is quite easy if it is just a matter of switching out a smaller chip for a bigger one so that it's a bit brighter and customers can underdrive for higher efficiency. We can open that up for a particular customer. As an example, we have started to serve low power packages with high CRI since we see a trend towards more light quality. We can easily follow this trend and simply adapt the phosphor that we developed for the low power, to COBs with high CRI - it depends on what the customer wants. Our marketing team also maps out what the requests could be from the market. For example, most requests for CRI 90 come from Europe and mid-power mainly comes from Europe, Korea and Japan.

LED professional: What is the base material, the substrate and package itself and will that change?

Ewing Liu: We are right in the process of very large changes with packaging material because of the different design trends and directions on the market. Both directions mainly go towards more cost effective products. First we have to make the package smaller - the less silicon or phosphors you need to fill the cavity - the lower the cost. We're going from sizes like 5630, 3528, 3020 right down to 2016 type sizes (2 mm x 1.6 mm) this is a very small LED with a low to mid power chip in it but you save a lot of the

packaging costs. When that happens you have less thermal dissipation. A standard PPA type of material might not be sufficient enough for some lifetime requirements so we may need to switch to a higher grade chip or we may need to switch to a different type of packaging material to dissipate heat from this chip so PPA goes to PCT with better heat dissipation. But these are still in the plastic realm. Another realm is called thermal molding; either epoxy molding compound (EMC) or silicone molding compound (SMC). There, thermal dissipation is significantly better than PPA and PCT. Everlight is focusing a lot more on thermal molding because performance is a lot better than plastic but price is not much higher. So everything is going in that direction. But in the next stage you want even better thermal dissipation and ceramic materials are probably the highest level you can get for an LED lifetime or reliability using a ceramic substrate. We offer all of these materials because, especially with ceramics, there are different types of applications. Our complete portfolio includes low, mid and higher power LEDs and COBs some with the EMC package already implemented. The size is smaller but we can still achieve 0.06 W to 0.5 W and potentially up to 1 W with the 2016. The higher the wattage, the better the material you need to use. But because it is so small it will still be more cost effective. Larger manufacturers like OSRAM and Philips who are very interested in these packages, also support this trend.

Another design trend is to increase the power of the package itself. This allows the customer to overdrive the package for more lumens while maintaining good performance. That means the lumen per dollar is a lot higher. So it is still the COB philosophy but instead of putting it on an aluminum or ceramic substrate we package it like standard LEDs in a 5050 type of package made of EMC. This can drive from 3 W all the way up to 9 W or 10 W and because standard EMC packaging material is a lot more cost effective than COB ceramic or aluminum, you have a much better cost vs. performance, high power product. This is on our latest roadmap.

LED professional: Another aspect is how tightly packed the LEDs are to get a low light emitting surface. Currently it looks like ceramic is the first choice for tightly packed systems. Is that also your view?

Ewing Liu: COB is one way that everyone is trying to get a smaller LES. Cree has one that is 6 mm and Everlight has one that is 5.7 mm. For a lot of the professional lighting products where you have to pair secondary optics, the smaller the package, the more lumens you can get. Everlight is doing that with our next generation of COBs. There is another concept of a smaller package with higher power called CSP or chip scale packages, where the substrate is 1.1 times the chip size used so you can make a very small LED. With that you have a lot of design flexibility. You can use one at very high lumens with optics, and control the light whenever you want or put a cluster together to have even more lumens from a small LES. Those are the two directions we are going to reach smaller or higher lumen density.

LED professional: Are you thinking about adding other components to the LED like optics, intelligence or drivers? What will come next?

Ewing Liu: I think for the European market there is more need for “value added”. Labor here is more expensive and it would be easier to buy a board with LEDs and optics designed in the application. They can just put it into the assembly and it becomes a fixture. That is a high demand from countries where labor is expensive. Everlight is not going in this direction right now but we have the capabilities if the need arises.

LED professional: High voltage components were also mentioned. What is your view and understanding of this?

Ewing Liu: This whole idea initially started because the pressure on LED components was too much. Dropping 30% to 40% per year in terms of component cost is too much and causes a lot of manufacturers to drop out; mainly the competitors from China that came up so quickly. They are trying to slightly take attention away from component cost. The driver is a big cost, especially for consumer products.



BEYOND NORTH AMERICA

- Obtain energy efficiency, performance, safety certifications and more
- Access global markets
- Leverage industry expertise and standards development
- Verify the quality of your lighting products

DISCOVER MORE AT
UL.COM/WEKNOWLIGHTING



Using high voltage LEDs you don't need to down convert or transform the different voltages as much.

At Everlight, we approach it from a high voltage DC perspective so you still need a bridge rectifier to convert AC to DC but from there you can go directly to a string. This saves a lot on the converter in the driver. For about 120 V you might need forty 3 V LEDs but we have chips with packages for 30 V or 48 V so all you need is three or four LEDs.

LED professional: Are single dies in series within the package or is it the monolithic chip approach?

Ewing Liu: Actually, both concepts exist. We use monolithic Epistar chips for our 30 V or 48 V HV LEDs, but we have also LEDs with slightly higher voltage compared to standard LEDs. These are 6 V, 9 V or 12 V packages consisting of multiple single chips which we connect in series inside the package.

Christopher Keusch: For example, for a high voltage bulb consisting of 30 V LEDs, basically the benefit is you can save drastically on driver cost using linear driver technology instead of the old driver concept with components that wear out a lot faster. For instance, capacitors tend to dry out. This doesn't happen with linear driver technology. In fact, we have high-end customers, even in Germany, who developed linear driving technology simply following the concept of using a lot of LEDs in series or using high voltage LEDs in order to connect them to main voltage. Some customers have eliminated ripples by these kinds of driving technologies.

LED professional: Is 48 Volts the maximum?

Ewing Liu: It could go higher but the price scheme would be a lot higher. Epistar has 50 V, 70 V and even a 110 V chip.

Christopher Keusch: It should be mentioned that there is a low voltage directive of 50 V so a lot of manufacturers have to consider that they may exceed this directive. But more customers now have the competencies to do proper isolation in order to allow using higher voltages. The low voltage directive is a hurdle but also an opportunity to build up competency.

Ewing Liu: Every direction we have talked about so far has been for cost-down, smaller packages, multiple chips and higher lumens per dollar or high voltage LEDs to reduce costs on total lamp cost through the driver. All have been cost driven types of designs. In the next 2 to 3 years there will be an overhaul of lighting manufacturers. Some might go out of business or naturally pull out because the margin is so low.

LED professional: Could you tell us more about tunable white COB technology?

Ewing Liu: This is also in the category of higher ASP (Average Selling Price) for professional lighting markets. In retail applications, you will often see a mixing of warm and cool white lamps. Or they might turn different lamps on at different times of the day. Using this type of COB technology, all you need is one lamp you can create any type of

color temperature you want. Other manufacturers make similar products. Ours is circular because the final application is usually a spotlight using a round reflector. Sharp, for example, uses a silicone dam in-between each color. We don't have anything in-between. We have a patented way of putting the phosphors right next to each other and keeping it separate so that everything can be shrunk even further.

LED professional: Many major players in this market are now looking at added value in the electronics provided. Right now the products have a very high quality and standard. Lifetime, reliability, color aspects, etc., are very important in the European market. One of these trends is Human Centric Lighting with controls, sensors, drivers, and so on. What are your comments about this trend?

Ewing Liu: This is true because the European market has to justify a higher price compared to Asian competition and they have to find their way in this very competitive business. However, since we are a components manufacturer we would like to serve these luminaire manufacturers within Europe and we would like to provide them with concepts and solutions to stay competitive so that they can provide this added value. Our core competency is packaging and our job is to do it as well as possible and meet requirements in terms of efficiency and competitive prices.

LED professional: Thank you very much. ■

**ASEAN'S LARGEST
INTERNATIONAL EXHIBITION ON
LED LIGHTING PRODUCTS & TECHNOLOGY**

THAILAND
LED
EXPO 2015

21 - 24 MAY, 2015
HALL 1-3
IMPACT EXHIBITION & CONVENTION CENTER,
BANGKOK, THAILAND

www.ledexpothailand.com

**LED EXPO THAILAND 2015
MOBILE APP NOW AVAILABLE!**

DOWNLOAD NOW!

Scan with your smartphone!



iphone & ipad



Android Phones & Tablets



ORGANIZERS



IMPACT Exhibition Management Co., Ltd.

Bangkok Land Building, 10 Floor, 47/569-576, Moo 3, Popular Road,
Banmai Sub-district, Pakkred District, Nontaburi 11120

Ms. Wong Wing Yan: Tel: +66 (0) 2833 2013

Ms. Panvisut Buranakarn: Tel: +66 (0) 2833-5328

Fax: +66 (0) 2833-5127 to 9



MEX Exhibitions Pvt. Ltd

9 LGF, Sant Nagar, East of Kailash,
New Delhi-110065, India

Ms. Himani Gulati Tel. : +91-9312285142, E-mail: himani@mexexhibits.com

Mr. Gaurav Juneja Tel. : +91-9810301644, E-mail: gaurav@mexexhibits.com

Fax : +91-11-41071644

Direct Current (DC) Supply Grids for LED Lighting

Since many alternative energy sources as well as electronics and controls technologies are based on DC current, DC grids have been investigated more intensely in the last decade. DC grids with a centralized AC/DC conversion have proven to be advantageous in server farms. While LED lighting is also a DC current related technology, an obvious choice would be to use DC grids for them. Prof. Eberhard Waffenschmidt from the Cologne University of Applied Science in conjunction with Philips Research presents the results of an office building DC lamp system installation with photovoltaic (PV) support.

Most electrical devices operate on direct current (DC) internally, but are supplied by alternating current (AC). A power supply with DC makes the rectifier electronics unnecessary. This makes the devices simpler and more reliable and generates less power losses. When many identical devices like lamps in supermarkets or open offices are operated, this becomes especially evident.

This publication aims to show solutions of DC operated professional buildings like offices or supermarkets and homes. A special focus is put on high voltage supply at 380 VDC.

First, the component effort for solutions with AC and DC current supply is compared. LED-lamps can especially benefit from a DC supply because lamp drivers can be reduced to a few reliable components and then a loss breakdown including transmission losses is presented. The major advantage of a DC supply appears if a micro-grid including decentralized energy generation and storage is considered. In addition, standardization initiatives working on high voltage DC grids are listed. Finally, an implemented office test bed including DC LED illumination and photovoltaic (PV) support is presented.

Introduction

One trend in lighting is to distribute light sources. This becomes possible with LED lamps, which offer a small amount but efficient light power. However, this also requires efficient lamp drivers. Furthermore, assigning each lamp its individual lamp driver becomes a high effort in material. Therefore, concepts are needed to deal with an increased number of similar lamp drivers. One solution could be to use a DC power supply. This makes omission of the rectifier electronics possible, which, in turn, makes the devices simpler, more reliable and generates less power losses. This is attractive especially in installations where a high number of lamps are connected to a power rail, like in open space offices or supermarkets (Figure 1). Each lamp contains an AC to DC conversion circuit, which can be omitted with a DC supply rail. This becomes particularly attractive if the system is combined with a local photovoltaic generator, as shown in [1].

DC supply systems are proposed by a number of publications especially for residential applications, e.g. [2] [3]. But as derived in [4], a large variety of different requirements for different devices, a DC system for residential applications faces even larger challenges. Contrarily, in



Figure 1: Lamp installations in open office space (left) and supermarkets (right)

lighting applications the loads are quite similar in their requirements and thus much better suited for a common DC supply.

Effort for AC to DC Conversion

Figure 2 shows the block diagram of a typical lamp driver operated on AC with the parts necessary for AC to DC conversion. Similar components are necessary for all AC power supplies.

The rectifier is the essential element and is typically a bridge rectifier consisting of four diodes.

The electrolytic capacitor (elcap) levels out the pulsating rectified sinusoidal voltage. Recently IEC SC77A WG1 agreed to a new review of the standard IEC 61000-3-2, which means that in the near future lamp drivers with more than 5 W will require a power factor correction (PFC) circuit. A PFC ensures that the current drawn from the grid is sinusoidal. The PFC may consist of an inductor, but this is usually too bulky. Especially for higher power levels a switch mode converter, typically a step up converter (boost converter) is used. However, this requires a filter to avoid higher frequency content generated by the switched mode PFC polluting the grid.

Space and components saving

Figure 3 shows a photograph of a Philips Xitanium lamp driver for a 39 W light emitting diode (LED) lamp as used in the reference setup. In the figure, all parts that are necessary for AC to DC conversion, are marked. As can be seen, approximately 40% of the printed circuit board (PCB) is occupied by these components. Especially the PFC and the filter circuit require a lot of space. The storage elcap is also significant, but the bridge rectifier itself is a comparable small component.

As discussed, these components might also be necessary for DC operation. An overview of this is shown in table 1. The bridge rectifier may be necessary to allow an arbitrary connection of the DC supply leads. However, this problem may also be solved by a suitable mechanical coding of the plug to avoid a wrong connection. The elcap may be needed to suppress voltage dips of the DC supply. However, it should be acceptable for lamps to pass the dips to the lamp and allow a short flicker. Then an elcap is not necessary.

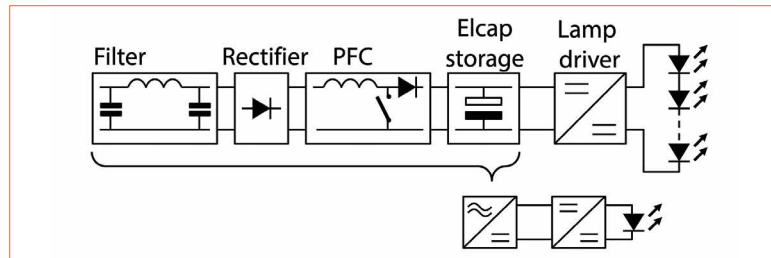

Figure 2: Typical AC lamp driver

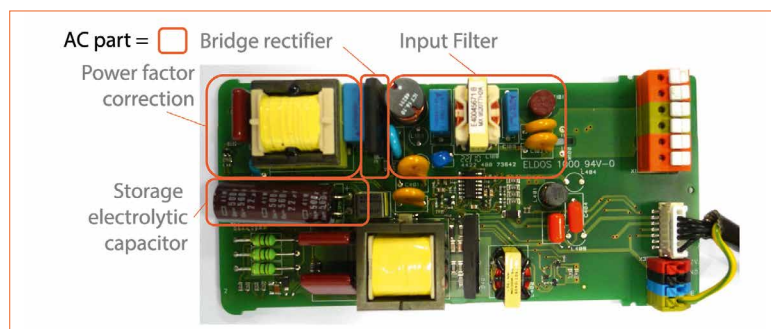

Figure 3: Power driver for a 35 W LED lamp

| Component | AC supply | DC wide voltage range and reverse polarity protection | DC narrow voltage range, mechanical rev. polarity protection |
|---|------------------------------|---|--|
| Filter | Required because of PFC | Required because of DC-DC | Can be omitted with linear driver |
| Rectifier | Required | Required for reverse polarity | Omitted |
| Power factor correction (PFC) / DC-DC converter | Required for P > 25 W | Required to match wide voltage range | Not necessary |
| Elcap storage | Required to avoid flickering | Required because of dips | Can be omitted, if dips are accepted |

Table 1: Overview of required components for AC to DC conversion

Figure 4:
Power and loss characteristic of a linear current controlled LED driver

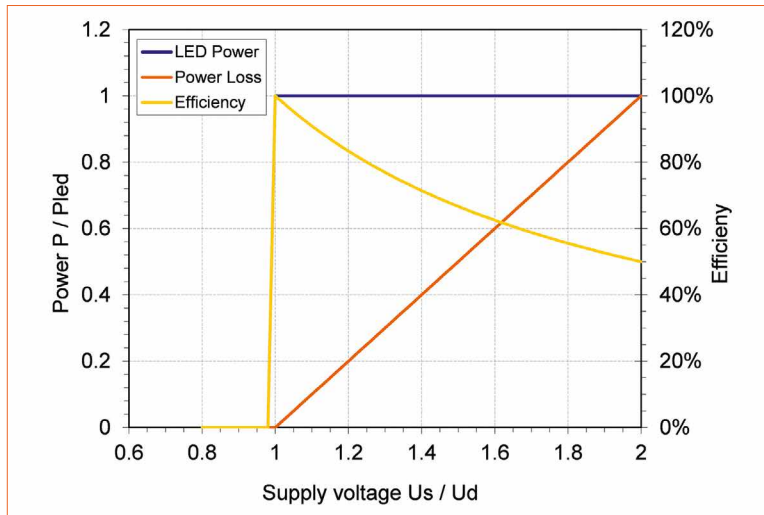

Figure 5:
Loss comparison of AC grid (a) and DC grid (b)

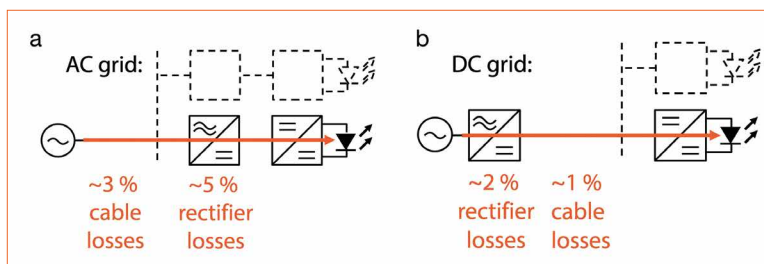
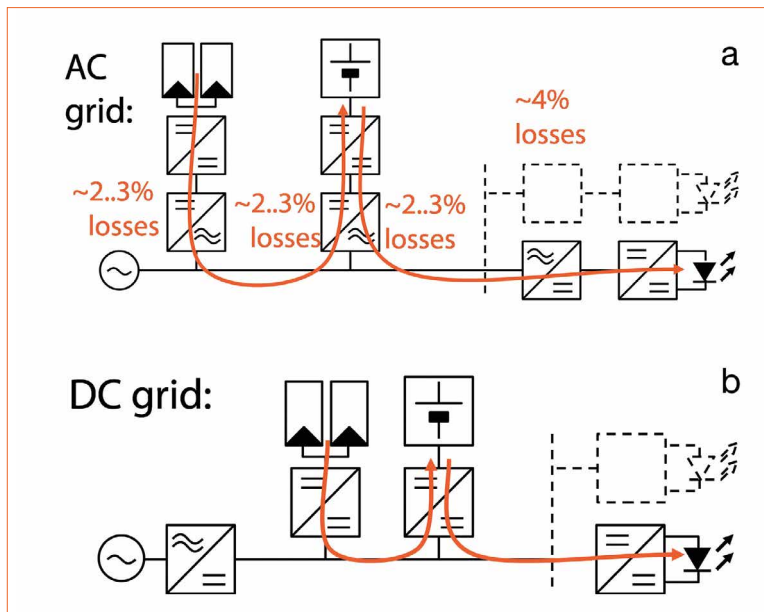

Figure 6:
Loss comparison of AC grid (a) and DC grid (b) with photovoltaic and battery storage operation



If the DC supply voltage has a large variation, it may be necessary to convert it to a constant level of an intermediate voltage. This requires a DC-to-DC converter, similar to an active PFC. However, if the DC voltage range has a narrow specification the DC-to-DC converter can be omitted.

The filter is necessary to suppress high frequency contents of switched mode converters. It becomes necessary if an active PFC is used.

If the lamp driver itself uses switched mode conversion, it remains necessary. However, with a linear lamp driver, even the filter may be omitted.

In conclusion, the components needed for AC to DC conversion can be omitted if the DC power plug is mechanically coded, if dips can be accepted, if the voltage is specified in a narrow range and, optionally, if a linear lamp driver is used.

Linear LED driver

The advantage of a lighting DC supply becomes most obvious with LED lamps. A most simple “driver” for an LED is simply a resistor. If the supply voltage is very well defined, this would be the most simple, reliable and durable “lamp driver”. However, if the voltage is less stable, the brightness of the LED would vary remarkably, because a small voltage variation would already lead to big changes of the output power.

A solution, nearly as simple, is a linear current driver. A linear current source can easily be built with one J-FET and one resistor.

The efficiency of such a circuit is good and is calculated assuming a constant forward voltage U_{of} of the LED and neglecting a residual voltage drop at the FET. The results are presented in figure 4. As long as the DC supply voltage U_s is larger than the forward voltage U_{of} the LED power (blue) is the nominal value. If the supply voltage increases above U_{of} the voltage across the FET rises linearly. The power loss in the FET (orange) increases proportionally to it. Efficiency (yellow) is calculated from the LED power and the losses.

If the voltage variation is within $\pm 10\%$ of the nominal voltage U_N (like in the public AC grid), efficiency can still be above 84%. This simple and reliable circuit can thus achieve similar efficiency to small-switched mode converters, as long as the voltage range is narrow enough.

Loss savings

The components needed for AC to DC conversion also generate losses. Typically, the smaller the device, the lower the efficiency. Our own measurements showed losses in the order of 5% of the output power for lamp drivers. This arrangement is shown in figure 5a. These losses can be avoided if the device is operated on DC. But if the AC grid supplies the DC grid, an additional central rectifier is needed. However, this central rectifier can be more efficient due to its larger size.

Its losses are estimated at about 2% of its output power, as illustrated in figure 5b. In addition, cable losses can be reduced if a DC voltage of 380 V is used, as shown in figure 7. In total, losses of about 5% of the output power could be avoided using a 380 V DC grid.

Even larger loss savings can be achieved in a different use case as illustrated in figure 6. It shows a system that is optimized for self-consumption of photovoltaic (PV) energy. The PV energy harvested during the day is stored in battery storage and used in the evening.

If all components are connected to the AC grid, losses in the AC to DC (and vice versa) converters end up to be 10% to 13% of the output power (Figure 6a). In a DC system, these losses can be completely avoided (Figure 7b). Reference [5] shows a similar result for such a system, where operation including PV and battery is considered.

Voltage Selection

The supply voltage of the DC grid also has an influence on the losses. Low voltages like 24 V or 48 V have the advantage of being safe to touch and commercially available devices exist. However, to transmit the same power, much higher current I is necessary compared to 230 V AC. A high DC voltage like 380 V is compatible to many 230 V AC devices, which operate on a similar intermediate DC voltage internally.

The power loss P_{loss} in the cable is proportional to the square of the current I : $P_{loss} \sim I^2$. Figure 7 shows the cable losses that appear at different supply voltages, scaled to the losses at 230 V AC. To achieve the same losses at higher currents, the cable cross sectional area A must also be scaled proportionately to the current: $A \sim I$. Therefore, the same figure 7 shows the amount of copper that is necessary to achieve the same losses as with the 230 V AC supply.

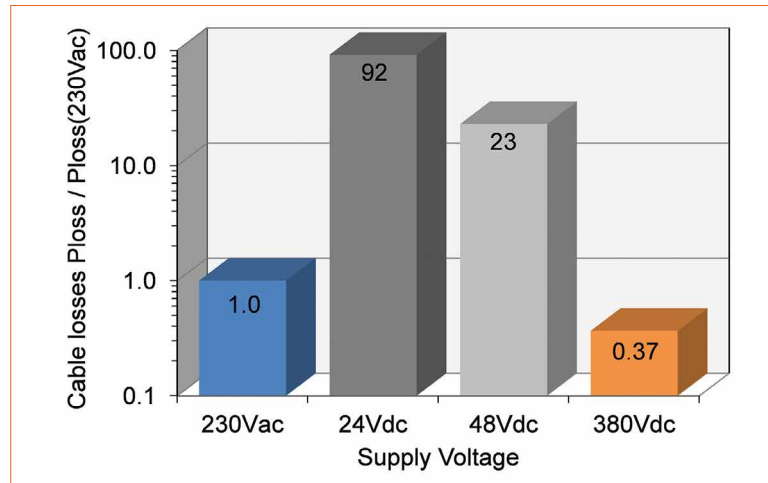

Figure 7: Comparison of cable losses for different supply systems. Losses are scaled to 230 VAC. Cable losses are equivalent to the amount of copper that is needed to achieve identical losses for the different voltages. Remark: 380 VDC requires similar insulation to 230 VAC

| Organization | Topic |
|---|--|
| International Electrotechnical Commission (IEC) | Many standards covering low voltage DC grid systems already |
| | SMB SG4 working group "LVDC distribution systems up to 1500V DC": Managing new standardization projects at IEC technical committees (TC) |
| | National standardization working groups. Germany: TBINK-LVDC working group at DKE/VDE |
| European Telecommunication Standardisation Institute (ETSI) | European standard: EN 300 132-3-1 V2.1.1 (2012-02) |
| | Value: Definition of DC appliance inrush current limits and measurement setup |
| EMerge Alliance | Standardization working group on 380 V DC power grids for datacenters |
| | Standardization working group on 380 V DC for campus and microgrids |

Table 2: Overview of organizations working on standardization of low voltage DC grids

It is clearly seen that the low voltages of 24 V and 48 V either generate extremely high losses or require significantly more copper. It also shows that a 380 V DC supply generates only about 1/3 of the losses compared to 230 V AC. It should be noted that insulation properties of 230 V AC cables are also suitable for 380 V DC operation because they need to withstand the peak voltage.

This safety issue is discussed with other safety issues in more detail in reference [6]. It concludes that operating at a DC voltage of less than 380 VDC can be considered similar to operating at 230 VAC. A further safety aspect of DC grids discussed is arcing, which mainly appears when a load is unplugged during operation. Therefore, one must take care that lamps are not exchanged during operation in a DC system.

Standardization on 380 V DC

The voltage level of 380 V DC is not only attractive for lighting applications, but also for other applications like the power supply in data centers. A standardized DC supply system will produce the most advantages. Table 2 gives an overview of the organizations that work on standardization and their current work.

DC Lighting Demonstration Setup

To demonstrate the functionality and to experience the problems related to it, a DC lighting demonstration is set-up in an office building at Philips Research in Eindhoven, The Netherlands.

Figure 8 shows a schematic overview of the system.

Figure 8:

DC-grid demo installation with solar support and an AC reference grid. Grid voltage: 380 VDC, Solar modules: 2 kW_{pk}, LED lamps: 56 x 37 W, adapted LED drivers, Reference system: 230 VAC

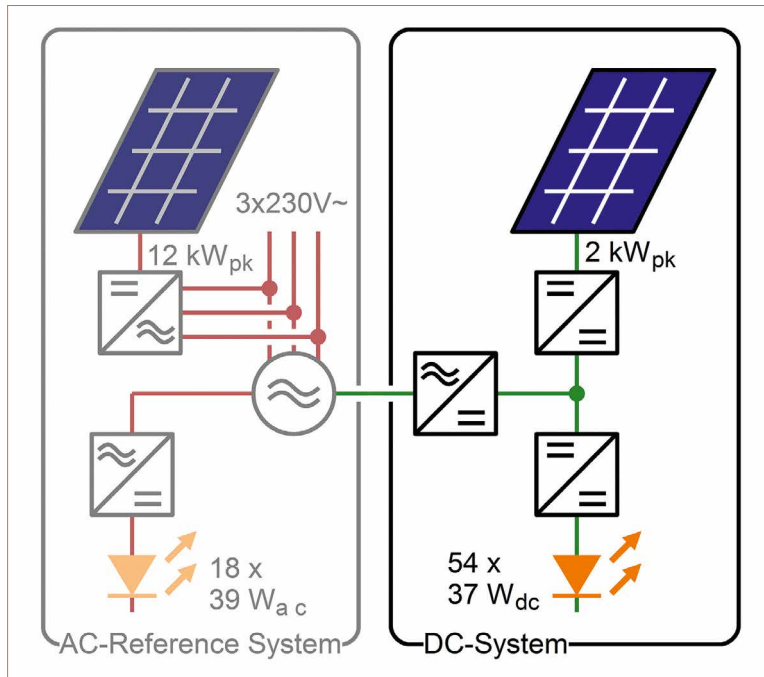
**Figure 9:**

Photos of the reference system: Photovoltaic panels (left), LED-Lamps (right)

**Figure 10:**

Comparison of total consumption in the DC system and the AC reference system. The energy in the AC system is scaled to the DC system

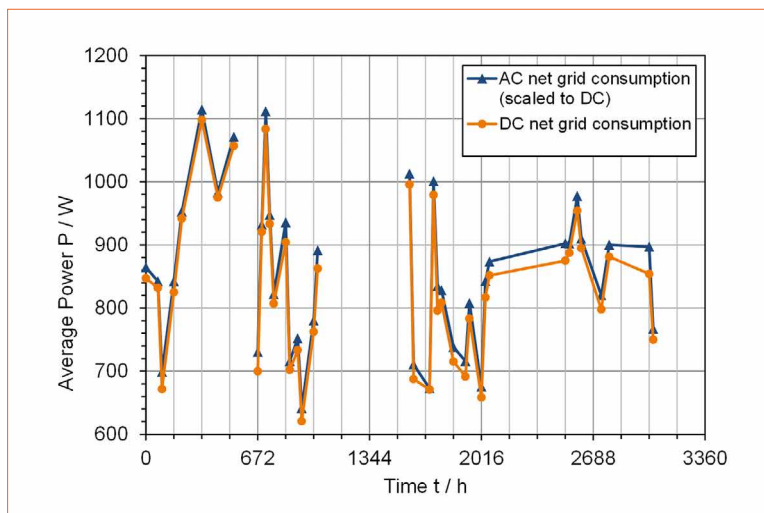

The DC part operates on 380 VDC and consists of a rectifier, a 2 kW_{pk} photovoltaic (PV) generator and 54 LED lamps with 37 W each. The lamps are driven by lamp drivers, which are adapted to the DC system. Figure 9 shows photographs of the PV panels and of some of the lamps. The lamps

illuminate the floor and are switched on during working hours throughout the day. In the best case, the PV generator is able to supply all the DC lamps. No feed in of PV power into the AC grid is provided. The lamps are Philips Xitanium lamps, with drivers modified for DC operation.

A 230 V AC system is also in operation as a reference. Here, the PV power is directly fed into the mains grid. Furthermore, 18 comparable AC operated Xitanium LED lamps are monitored.

In the DC system the energy drawn from the mains grid is monitored. In the reference AC system, the energy needed by the lamps (including drivers) and the energy generated by the photovoltaic system (grid feed in) is monitored. To get a comparison, the needed lamp energy in the AC system is scaled to the number of lamps in the DC system. The generated PV energy in the AC system is scaled to the size of the DC PV system and finally both values are subtracted to achieve a net energy demand comparable to the DC system. Data was measured from April 29th, 2013 until Sept. 6th, 2013. The average power was calculated from the monitored energy. The results are shown for the DC power demand and the scaled AC power demand in figure 10. There are two gaps in the data resulting from failures and maintenance time, which are not considered for the final comparison. The figure shows that the power demand of the DC system is always lower than that of the comparable AC system. In total, the DC system demand was 2132.6 kWh, while 2181.4 kWh relate to the scaled AC system. In conclusion, the DC system energy demand was 2.24% lower than the comparable AC system.

Conclusion

Operating lamps and other devices with a residential DC grid offers two major benefits:

Overall power losses can be reduced. However, for a supply of the residential DC grid from a public AC grid, this effect is partly compensated by losses in the central rectifier. But energy savings become especially visible with the integration of additional local power sources.

LED CHINA 2015



The World's Largest LED and LED Lighting Event
16 - 19 September 2015
 Shanghai New International Expo Centre

• 80,000 sqm in exhibition space • 90,000 domestic & overseas visitors • 1,200 exhibitors and brands
 (The above are projected numbers)

Expect even more from the most influential event in the Sign industry with our move to **Shanghai!**



Organizer
UBM Trust Co Ltd
 Tel: 86 20 3810 6261, 3810 6263
 Email: sign-trust@ubm.com
 Website: Website: www.LEDChina-sh.com

Shanghai Office
 Tel: 86 21 6157 3921
 Email: info-trust@ubm.com

Our Network:

Japan
 Tel: 81 3 4360 5664
 Email: ubmcanonjapan@ubm.com

Taiwan
 Tel: 886 2 2738 3898
 Email: info-tw@ubm.com

Korea
 Tel: 82 2 6715 5406
 Email: jameshj.lee@ubm.com

USA
 Tel: 1 516 562 7855
 Email: cecilia.wun@ubm.com

As a further benefit, complexity can be reduced in the powered devices by shifting it into the infrastructure. This can make the devices more durable and reliable. Especially for mass products like lamp drivers and consumer devices, which are manufactured and used in a huge number, this will reduce the overall cost.

From a system point of view, it is advantageous to make those devices, which are needed in large numbers as simply and cheaply as possible and to allow a few central devices to be more complex. This cost advantage should be considered as the main benefit of the DC system.

The specification of a DC system should take these benefits into account: To reduce losses in the distribution system and the voltage should be as high as possible. For lamps, an operating voltage like 380 V DC is proposed. To allow the reduction of complexity, the definition of a narrow voltage tolerance is required. ■

References:

- [1] Ulrich Boeke, Matthias Wendt, Lennart Yseboodt, "Combined Solar and AC Mains Powered LED Lighting System", 14th European Conference on Power Electronics and Applications (EPE'11), Birmingham, United Kingdom, 30. Aug. - 1. Sept. 2011.
- [2] T.-F. Wu, Y.-K. Chen, G.-R. Yu, Y.-C. Chang, "Design and Development of DC-Distributed System with Grid Connection for Residential Applications", 8th International Conference on Power Electronics - ECCE Asia, May 30 - June 3, 2011, The Shilla Jeju, Korea, paper no. TuF1-4.
- [3] Rakwichian Wattanapong, "Community Smart Grid for ASEAN Decentralize Power", Presentation at World Alternative Energy Forum, Chiang Mai, Thailand, 12.-14. Dec. 2012. (Online available (29.6.2014) at <http://www.adicet.cmru.ac.th/waef2012/>)
- [4] Bernhard Scheeren, "Optionen für eine Gleichstromversorgung in einem Wohnhaus", Masterthesis at Cologne University of Applied Science, Institute for Electrical Power Engineering, Cologne, Germany and Zuyd Hogeschool, Heerlen, The Netherlands, 16. April 2014.
- [5] Suponthana Wuthipong, "MW Scale Stand-Alone PV Hybrid Mini Grid System", Presentation at World Alternative Energy Forum, Chiang Mai, Thailand, 12.-14. Dec. 2012. (Online available (29.6.2014) at <http://www.adicet.cmru.ac.th/waef2012/>)
- [6] Jung-Hoon Ahn, Dong-Hee Kim, Byoung-Kuk Lee, Hyun-Cheol Jin, Jae-Sun Shim, "DC Appliance Safety Standards Guideline through Comparative Analysis of AC and DC Supplied Home Appliances", Journal of Electrical Engineering & Technology Vol. 7, No. 1, 2012, pp. 51~57, (Online available (29.6.2014) at: <http://dx.doi.org/10.5370/JEET.2012.7.1.51>)

Solving the Phase-Cut Dimming Challenge

The evolution of dimmable LED lighting is an ongoing subject and phase-cut dimming is often dissatisfactory. While some weaknesses may be acceptable in residential applications, they are definitely not acceptable in professional applications. Stage lighting, studio lighting, TV and movie lighting set the highest standards. Craig Sharp and Bill Trzyna, Research & Design Engineers at CCI Power Supplies LLC discuss which developments helped to overcome limiting obstacles and led to a solution that also satisfies stringent requirements.

Stage lighting has always been one of the most progressive and advanced lighting applications. Using a vast number of different filters for accurate color appearance or unlimited light levels from zero to full brightness to support different scenes are examples of this. Some of these tasks have become simpler with LED lighting, but others, like dimming, have become more complex and challenging. It comes to no surprise, then, that stage, studio, architectural, and other high-performance lighting professionals are about to raise the curtain on full-range LED dimming again. This giant leap was recently made possible by the introduction of a new LED power supply dimming technology being studied and adapted by LED lamp and fixture manufacturers.



Figure 1: Stage lighting is certainly one of the most challenging tasks. Correct light distribution and light level are necessary to highlight the graceful moves of a ballerina

Early Days of Dimming

With the advent of the electric light, the need for dimming was immediate. It was easy to turn down the lights with a simple valve when gas illumination was the rule. But those new-fangled electric lamps posed a challenge. The first method commonly in use placed jars of salt water in series with the lamps. The electrodes could be withdrawn to vary their resistance and throttle the current flow to the lamps. In 1890 Granville Woods invented the safety dimmer, a form of resistance wire rheostat (flow control), which persists in some installations to this day. Both of these methods generated a tremendous amount of heat and sometimes caused fires. In 1933 General Radio announced the invention of the Variac (a contraction of vary AC), a continuously adjustable autotransformer. This was a major improvement in dimmer technology, substantially reducing the power wasted in comparison to resistive dimmers. However, like the rheostat, it is a mechanical device that adjusts slowly.

Phase-Cut Dimming

In 1959 Joel Spira invented the SCR (silicon controlled rectifier) controlled dimmer and a year later Eugene Alessio announced a TRIAC (Triode for AC) controlled dimmer. These thyristor-based controls are the mainstay of dimmer technology today, although the IGBT (Insulated Gate Bipolar Transistor) is used in some of the newest dimmer designs because it is an easier device to drive and control.

All of these devices work by cutting off part of each half cycle of the AC line waveform. The amount that's cut off is measured by the phase angle. A complete sine wave is 360 degrees in length; a half wave is 180 degrees. If the dimmer cuts off 90 degrees of each half cycle, the effective voltage applied to the lamp is reduced by half because only one half of the waveform or 180 degrees remains.

Phase-cut dimmers can operate on the leading edge (forward phase-cut) or trailing edge (reverse phase-cut) of the waveform. Forward phase-cut developed naturally from the thyristor behavior. The SCR or TRIAC is triggered to turn it on and it turns off when the waveform crosses zero voltage. Reverse phase-cut dimming was developed to improve performance of low voltage halogen lamps operating on an electronic transformer, a type of switch mode power supply.

Let's look at some of the challenges in controlling LED lamps with phase-cut dimmers, because this technology has dominated the market for decades and there's a huge installed base of these dimmers.

Simple phase-cut dimmers are connected in series (two wires) with an incandescent lamp and can only draw power for its electronics during the period when the AC line is cut off. This is when there is voltage present across the dimmer. More sophisticated dimmers require more power for their electronics and have an added wire (three wires) provided to power their electronics. A dimmable LED fixture has only the two wires from the dimmer to provide power, without the benefit of the full line voltage being present during the cut off part of the phase. Thyristor based dimmers require a minimum load current for proper

operation. The dimmable LED fixture has to provide this load current even at low line voltage, which is contrary to the improved efficiency of the LED compared to an incandescent lamp.

Because of these limitations dimming LED fixtures with existing phase-cut systems were generally unsatisfactory. Dimming below 30% brightness was unreliable. Fixtures would pop on as the dimmer control was advanced. Sometimes the fixtures would behave erratically, cycling between zero and full brightness. To overcome these limitations, technology developers have looked to digital methods for LED dimmable control. In many fields of engineering, digital innovation has often removed barriers to improved product performance and application cost. Could a digital solution similarly be written for LED dimming?

The Digital Dimming Dilemma

Both dimmers and drivers have various requirements that must be met so as to achieve smooth LED operation. Digital dimmers are one of the toughest problems to solve with LED lamps because the microprocessor requires power even while the dimmer is off. This results in a small current, typically around 20 mA that needs to flow through the lamp when the light should be off.

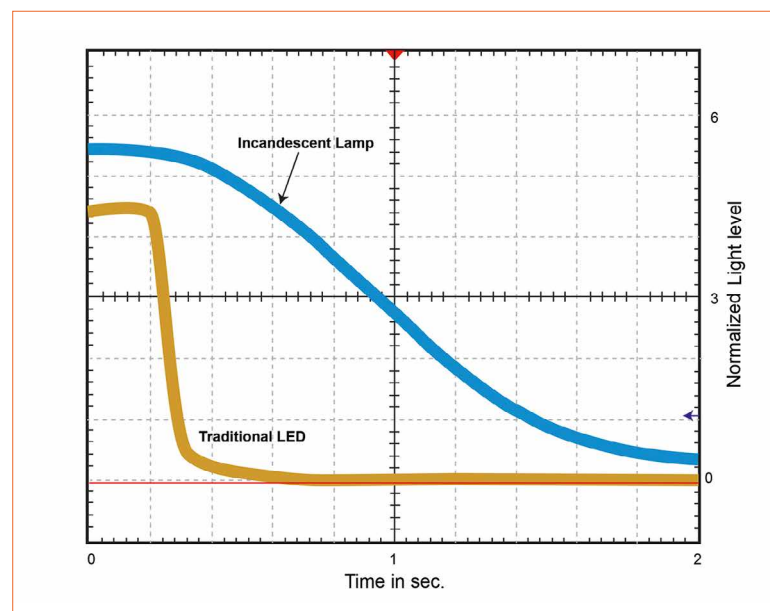
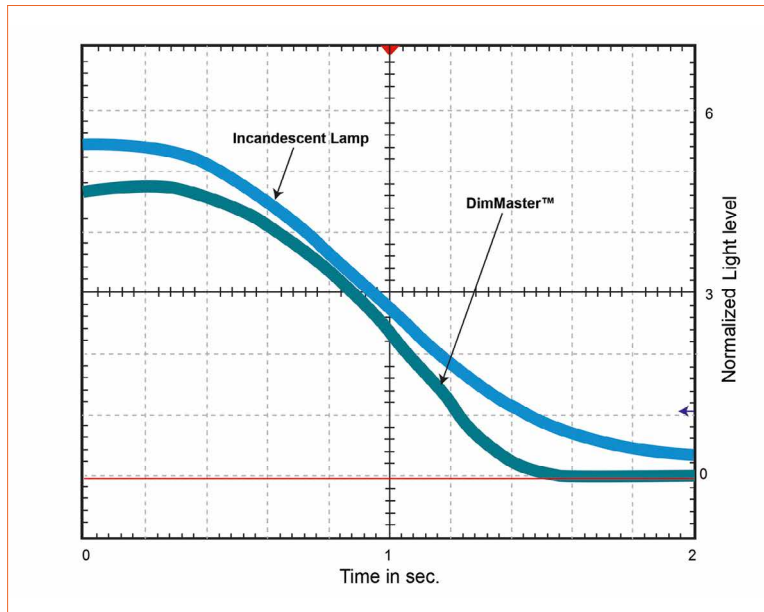

Figure 2: The relative light output curve of a digitally controlled LED dimming power supply fails to produce the low-end, full-range “S” curve that is characteristic of traditional incandescent dimming. This has been characteristic of LED dimming attempts to date

Figure 3:
A recently introduced LED dimming technology produces an “S” curve that emulates the light output of traditional incandescent dimming. Importantly, low end dimming for scene exits and transitions is closely emulated



The drivers must convert a chopped AC signal from the dimmer into a steady DC signal for the LED's in order to emit a constant light, while interpreting the altered waveform to the appropriate dimming level. In other words, drivers must be designed to interpret a duty cycle modulated signal and transfer the information to constant current output levels. As the conduction phase angle is decreased, the output current must also decrease. Providing constant light output requires a balancing act between drawing current through the AC waveform while it is being cut out by the dimmer. Storing power in capacitors and inductors helps provide power when there is none.

How the New Technology Works

The ultimate challenge around LED dimming is to satisfy the aesthetic eye of the technical artist. When it comes to utilizing high wattage stage and television lights, the technical producer is looking for flicker-free lighting with smooth dimming from less than 1% to 100% just as one would experience with an incandescent light fixture. This has been extremely difficult to achieve up until now.

A recently introduced LED power supply dimming technology called DimMaster™ is compatible with

phase controlled dimming, resistive or auto-transformer dimming and can also be controlled via an RS 485 bus. A key engineering objective behind the technology has been to provide a smooth, full-range dimming curve, no matter what type of dimming system the customer used. Powered by this driver type, a LED lamp can mimic an incandescent lamp's dimming behavior, so that in the theatrical, stage and TV world, a newly integrated LED lighting fixture can seamlessly blend, and therefore support, a venue's transition from incandescent to LED over a cost-managed period of time.

The inner workings of a typical LED fixture include a switching power supply that is more complex than the electronic transformer used for low voltage halogen lamps. The power supply rectifies the line voltage and then reduces the voltage to a level suitable for the LED driver. It may feature sophisticated controls, DMX or WiFi, but it is incompatible with AC line controlled dimming. The new LED power supply technology also powers the LED driver. Additionally, it provides two AC line dependent pulse width modulated (PWM) control signals to the LED driver that regulates the current through the LED array. The driver can now regulate the LED current in proportion to the effective AC

line voltage. The relationship between the PWM signals and effective line voltage is defined in the microprocessor programming to produce the desired dimming curve.

When an AC line dimmer is set for low brightness, the effective voltage applied to the fixture is low. Because of this, the power supply in an AC line dimmable fixture has to operate down to extremely low input voltage. It also has to provide a minimum load for thyristor phase-cut dimmers or they will malfunction. Another challenge is suppressing electromagnetic interference from the switching supply without inducing ringing of the AC line current, which can also cause thyristor phase-cut dimmers to malfunction. Often this malfunction is exhibited as strobing or pulsation, or sometimes the brightness varies erratically like the flickering of a candle. The new LED power supply dimming technology incorporates a power factor corrected front end and matching EMI filter developed specifically for this application. It operates down to extremely low input voltage and presents an appropriate load for phase-cut dimmers, even during the narrow conduction angles necessary for low brightness settings, while meeting FCC Class B conducted emissions limits.

A particularly annoying behavior of some AC line dimmable LED fixtures is called popcorn turn-on. As the dimmer's brightness setting is increased, the fixtures turn-on at different levels and times, creating the popcorn effect. In the new technology approach, a separate control power supply starts up first then the microprocessor monitors the AC line to determine when the PWM outputs will commence operation. This sequence is not as dependent on the dimmer setting or the main power supply start-up time, effectively eliminating popcorn-turn-on.

For high-end LED fixtures, compatibility with video cameras is also a great concern. Some

guangzhou international lighting exhibition

广州国际照明展览会



**The most influential and comprehensive lighting
and LED event in Asia**

9 – 12 June 2015

China Import and Export Fair Complex
Guangzhou, China

www.light.messefrankfurt.com.cn

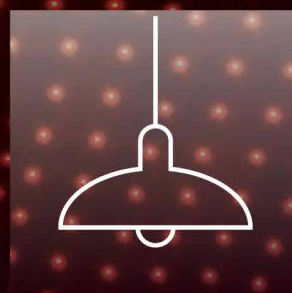
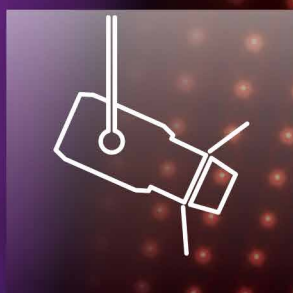
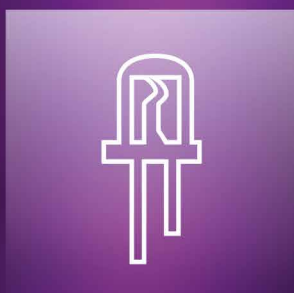
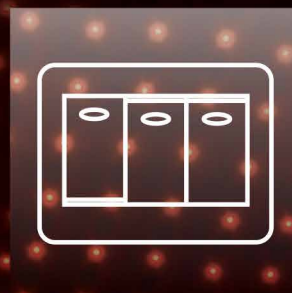
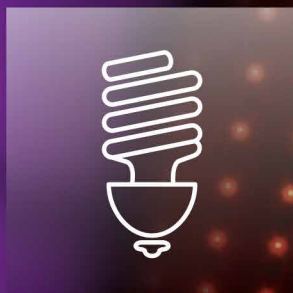
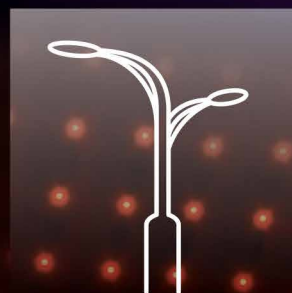

Contact

Messe Frankfurt (HK) Ltd

Tel: +852 2238 9969

Fax: +852 2519 6079

light@china.messefrankfurt.com



 **光亞 · Guang ya**

 **messe frankfurt**

Figures 4a-c:

- (a) Analog controlled LED dimming.
 (b) Digital controlled LED dimming.
 (c) DimMaster™ controlled LED dimming

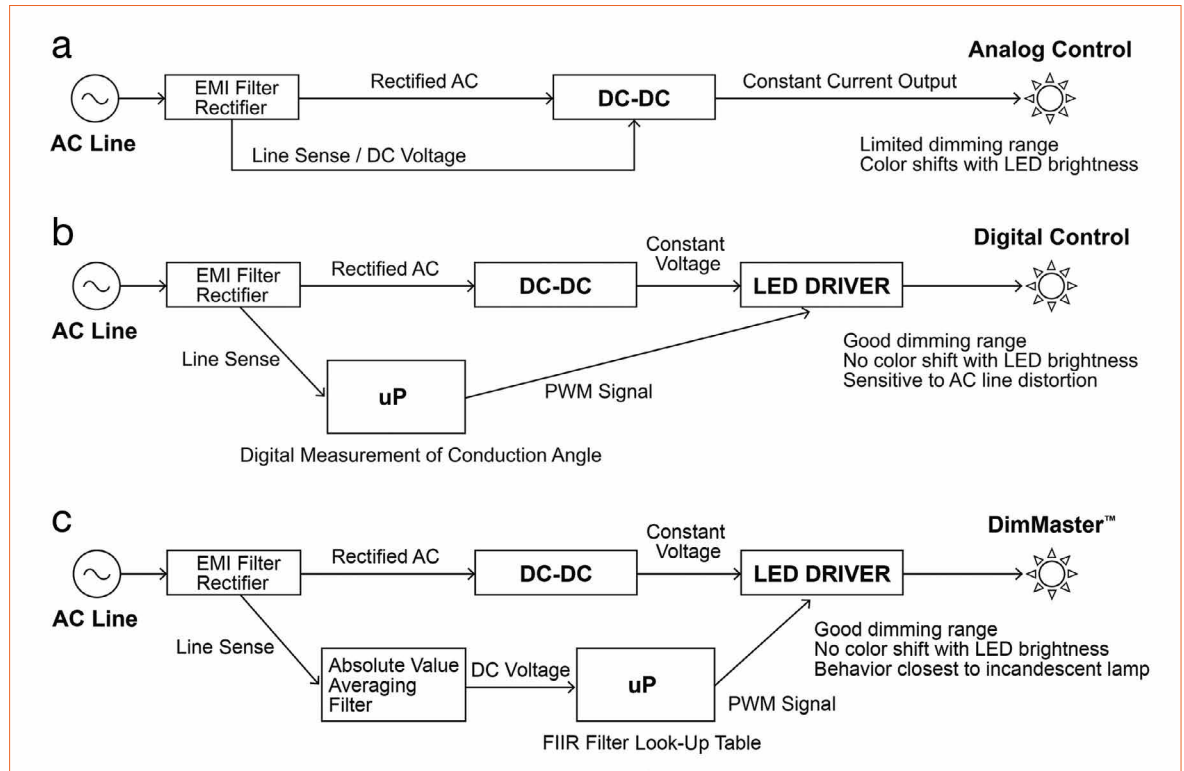

dimnable fixtures control the LED current by producing a burst of pulses from the LED driver, which causes a flickering brightness of video displays. Other LED fixtures switch continuously, but at a relatively low frequency, which is good for efficiency, but causes a venetian blind effect of light and dark horizontal bands across the video display. Alternatively, the new technology's PWM output presents a continuous stream of pulses at a frequency high enough to eliminate the venetian blinds effect, but not so high that it reduces efficiency.

The first dimmable LED power supplies used an analog control approach (Figure 4a). They sensed the rectified DC value of the line voltage and used this to directly control the output current of a switched mode power supply. The most common topology for the DC-DC stage is the flyback, because it is a good choice for low cost at low power and it can also provide power factor correction as in a single stage. This is still a popular approach for consumer-oriented LED lighting. Often the dimming range is limited and the color of the light shifts as the current to the LEDs is reduced.

Along with higher power LED lighting came the demand for better dimming characteristics. Analog controls for constant current, PWM LED drivers were developed that improved efficiency and eliminated color shift with changes in brightness. Digital controls that generate the PWM signal after calculating the conduction angle from the measured line voltage parameters were developed (Figure 4b). With this approach, the dimming characteristics could be precisely adjusted, but distortion of the voltage waveform and transients on the AC line can disturb the brightness setting. Measuring the conduction duration is attractive, because it is easy to implement in the microprocessor program. However, this measurement is frequency sensitive and it is unable to determine the brightness setting of non-phase controlled dimmers.

The new LED power supply technology uses a hybrid approach to sensing the effective line voltage, which does not depend on directly measuring the conduction duration (Figure 4c). The new approach integrates the absolute value of the AC line voltage waveform and then measures the result to determine

the dimmer setting. The approach is compatible with all forms of AC line controlled dimming. If you happen to be using jars filled with salt water as your dimmer it will work with that too.

Conclusions

By closely emulating an incandescent lamp's dimming behavior, improved LED power supply dimming technology will enable those in the theatrical, stage and TV world to seamlessly blend their differently generated lighting to make the transition from incandescent to LED over a cost-managed duration.

Venue owners and stage managers can incrementally and cost-affordably retrofit their incandescent systems to LED, with no loss in lighting performance. Full-range, high performance LED dimming is about to take center stage. ■



The 13th International

LED & OLED

EXPO 2015

2015. 6. 23 - 26 / KINTEX, Korea

Concurrent Exhibition : Int'l LASER EXPO 2015

Why should Exhibitors Choose LED & OLED EXPO?

Certified Exhibition

- ✓ World's first B to B trade show for the LED industry (in 2003)
Certified by UFI (Union des Foires Internationales) and by Ministry of Trade, Industry & Energy(Korea)

Supported by Korean Government

- ✓ "Promising Trade Show" by the : Ministry of Trade, Industry & Energy for 9 consecutive years(2006~2014)

A Major, Must-Attend International Event for Business Development and Networking

- ✓ Top-tier companies from around the world
Industry leaders from Korea, Japan, China, Southeast Asia, Europe and North America
1:1 business matchmaking service based on request submitted by exhibitors in advance

Newest Technology and Trends

- ✓ Top business, academic and government speakers to address future market and technology issues
Insight and information to help exhibitors guide your business successfully into the future



LED & OLED EXPO 2015 Secretariat

TEL : +82-2-783-7979 FAX : +82-2-783-7292

E-mail : led@exponu.com / oled@exponu.com

Website : www.ledexpo.com / www.oledexpo.com

LED Lighting for Horticulture

Solid-state lighting is increasingly being used in horticultural applications, including greenhouses and indoor “vertical farms”. To meet the needs of the horticultural industry, SSL manufacturers and lighting designers will need to understand the spectral power distribution requirements of photosynthesis for optimal plant health and growth. Ian Ashdown, Chief Scientist of **Lighting Analysts**, provides an overview of plant action spectra and how to convert lumens and lux into units of PAR and PPF.

There is a bright future for solid-state lighting in horticulture, including greenhouses and indoor “vertical farms”. For SSL product manufacturers and lighting designers, however, the problem is that horticulturalists speak an unfamiliar language. Success in this market will depend on a basic understanding of plant photosynthesis and the spectral power distribution (SPD) requirements for optimal plant health and growth. SSL manufacturers and lighting designers will also need to understand how to convert photometric units of lumens and lux into Photosynthetically Active Radiation and Photosynthetic Photo Flux Density for different light sources, including both white light and quasimonochromatic LEDs. For horticulturalists, the availability of multichannel SSL luminaires with color-tunable SPDs will provide new opportunities to explore the unique spectral requirements of different crops and the integration of SSL products with greenhouse climate control systems.

Plant Photosynthesis

Photosynthesis is the process used by plants to convert electromagnetic radiation - light - into chemical energy that is used for growth and development. All that is needed for this process is carbon dioxide (CO₂), nutrients, and water. The process itself is not particularly efficient; only 4 to 6 percent of the absorbed radiation is converted into chemical energy [9]. Still, it is the engine that drives most life on this planet.

Photosynthetically active radiation (PAR) is defined as electromagnetic radiation over the spectral range of 400 nm to 700 nm that photosynthetic organisms are able to use in the process of photosynthesis to “fix” the carbon in CO₂ into carbohydrates. Horticulturalists measure PAR for both plant research and greenhouse lighting design using specialized photometers [1].

A common unit of measurement for PAR is photosynthetic photon flux density (PPFD), measured in units of moles per square meter per second [i]. In this case, every absorbed photon, regardless of its wavelength (and hence energy), is assumed to contribute equally to the photosynthetic process. This is in accordance with the Stark-Einstein law, which states that every photon (or quantum) that is absorbed will excite one electron, regardless of the photon’s energy, between 400 nm and 700 nm. For this reason, photosynthetic photon flux is also referred to as quantum flux.

Whether a photon with a given wavelength is absorbed by a plant leaf is dependent on the spectral absorptance of the leaf, which in turn, is determined largely by the leaf optical properties, including the concentration of plant photopigments such as chlorophyll A and B, various carotenoids (carotenes and xanthophylls), and anthocyanins. (The chlorophylls are responsible for the characteristic green color of leaves; the carotenoids and anthocyanins contribute to the yellow, orange, and red colors respectively of autumn leaves after the chlorophylls decompose.)

Typical absorptance spectra for chlorophyll A, chlorophyll B, beta-carotene, and two isoforms of phytochrome are shown in figure 1. It must be noted, however, that these spectra are approximate. They are measured in vitro by dissolving the pigments as extracts in a solvent, which affects their absorptance spectra. By themselves, they suggest that blue and red LEDs alone are sufficient for horticultural applications. In reality, however, the situation is much more complicated.

Photosynthetic Action Spectra

McCree [4] measured the quantum yield of CO₂ assimilation for the leaves of 22 species of crop plants [ii]. Taking the average measurements at 25 nm intervals for all plant species, he produced an action spectrum plot (Figure 2) that is representative of most crop plants. -

PHOTOSYNTHESIS AND VISIBLE LIGHT

For illumination engineers, it might seem suspicious that the photosynthetically active radiation is defined over the spectral range 400 nm to 700 nm - exactly the range we commonly assume for human vision. What about longer and shorter wavelengths?

When McCree [4] measured his 22 crop species both in the field and in laboratory growth chambers (with very similar results), he obtained the following action spectra.

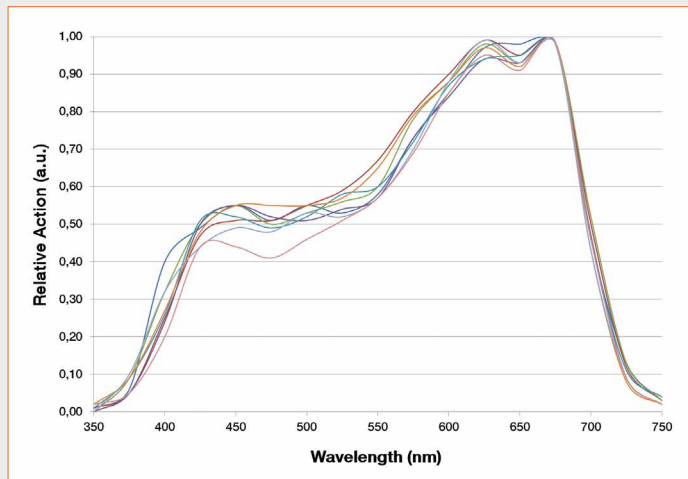

The action spectra clearly explain the logic of the 400 - 700 nm spectral range

Below 400 nm, there is the risk of photooxidation that generates toxic radicals, which can destroy the cell's chlorophyll and other cellular components. Under intense UV radiation, violaxanthin (which is involved in photosynthesis) is converted via the xanthophyll cycle into zeaxanthin. In doing so, it receives excess energy from chlorophyll and releases it as heat. This process thereby offers the plant photoprotection.

At the same time, other plant photopigments, including cryptochromes and phototropins, do have sensitivities (as measured in vitro) that extend into the ultraviolet, and likely

respond under dim light conditions. However, these are likely suppressed under high light conditions by the xanthophyll process.

Above 700 nm, the photon energy is too low to activate the photosynthetic process via the chlorophylls and various carotenoids. However, the phytochrome photopigment, which is responsible for stem elongation, leaf expansion, shade avoidance, neighbor perception, seed germination, and flower induction, has two isoforms called Pr and Pfr. In its ground state Pr, phytochrome has a spectral absorbance peak of 660 nm. When it absorbs a red photon, it converts to its Pfr state, which has a spectral absorbance peak of 730 nm. When the phytochrome molecule absorbs a far-infrared photon, it converts back to its Pr state, and in doing so triggers a physiological change in the plant.

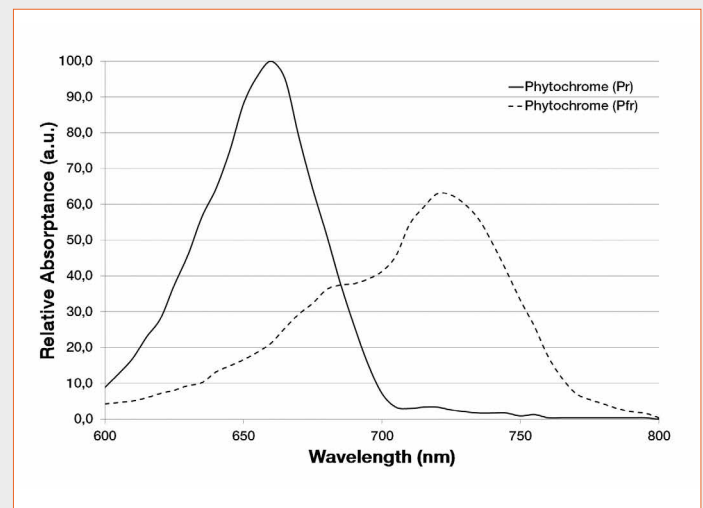

Phytochrome action spectra

Chlorophyllous leaves are transparent to infrared radiation. So the phytochrome signaling mechanism is ideal for sensing the lighting environment on forest floors and in the presence of neighboring plants competing for available direct sunlight.

Ian Ashdown, P. Eng., FIES, Chief Scientist, Lighting Analysts Inc.

An action spectrum is simply a plot of biological effectiveness as a function of wavelength of incident light.

As noted by McCree [4], PPFD is not a perfect measure of photosynthetically active radiation in that it systematically overestimates the effectiveness of blue light relative to red. It is useful, however, in that it is independent of any particular plant species, and it can be measured both in the laboratory and in the field using a radiometer with a spectrally-calibrated quantum sensor such as the LI-190SA from LI-COR [5].

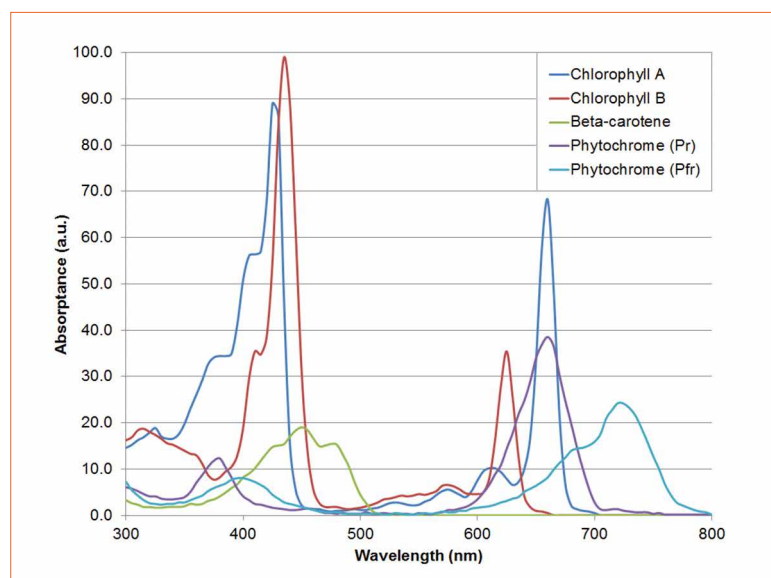

Figure 1: Photopigment spectral absorbances

Figure 2:
Action spectrum
for crop plant
photosynthesis

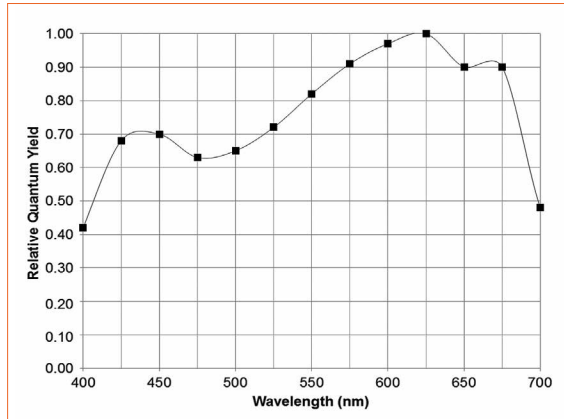

Figure 3:
5000 K LED relative
spectral power
distribution

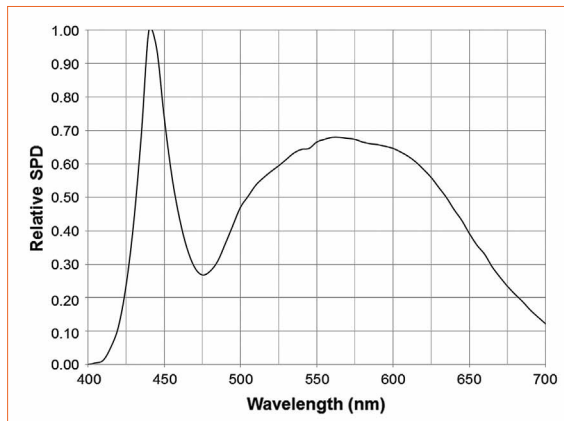
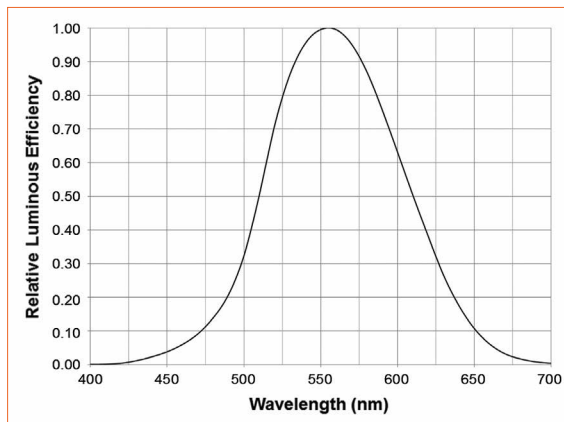

Figure 4:
CIE 1931 luminous
efficiency function V(λ)



From Lux to PPFD

As lighting designers, we need some method of converting lumens to quantum flux (PAR) and illuminance to quantum flux density (PPFD). But we can do so only if we know or can estimate the spectral power distribution (SPD) of the light source.

Suppose then that we have a light source with a known relative spectral power distribution (SPD), such as, for example, a typical 5000 K “cool white” LED (Figure 3).

One watt of radiant power at 555 nm is, by definition, equal to 683 lumens. Given the CIE 1931 luminous efficiency function (Figure 4), we can calculate the spectral radiant flux $\Phi(\lambda)$ in watts per nanometer for each lumen as:

$$\Phi(\lambda) / lm = \frac{W_{rel}(\lambda)}{683 \sum_{400}^{700} V(\lambda) W_{rel}(\lambda) \Delta\lambda}$$

where $W_{rel}(\lambda)$ is the relative spectral power distribution, $V(\lambda)$ is the luminous efficiency function at wavelength λ , and $\Delta\lambda$ is the wavelength interval (typically 5 nm). For the above example, the spectral radiant flux per nanometer for each lumen at 440 nm is 22.5 microwatts, while the total radiant flux per lumen is 3.18 milliwatts.

With this, we can calculate the photosynthetic photon flux (PPF) per nanometer in micromoles per second per nanometer:

$$PPF / nm = 10^{-9} \cdot \frac{\lambda \Phi(\lambda)}{(N_a \cdot 10^{-6}) hc}$$

(where N_a is Avogadro’s constant), while summing over the range of 400 nm to 700 nm yields the photosynthetic photon flux (PPF) per lumen for the given light source:

$$PPF = \frac{10^{-3}}{N_a hc} \cdot \sum_{400}^{700} \lambda \Phi(\lambda) \Delta\lambda \approx$$

$$8.359 \cdot 10^{-3} \cdot \sum_{400}^{700} \lambda \Phi(\lambda) \Delta\lambda$$

Given an illuminance value (lumens per square meter) and knowing the light source SPD, we can similarly calculate the photosynthetic photon flux density (PPFD) in micromoles per second per square meter ($\mu\text{mol}/\text{sec}\cdot\text{m}^2$) for the given light source. Again for the above example, one kilolux is equal to 14.62 $\mu\text{mol}/\text{sec}\cdot\text{m}^2$.

Conversion Factors

It is easy enough to find graphical representations of light source spectral power distributions, but it is considerably more difficult to find this information in tabular form suitable for the above calculations. Fortunately, this information is published in CIE 15:4, Colorimetry [2]. It does not include white light LEDs, but this information can be obtained by digitizing manufacturers’ product catalog data (e.g., [6]).

Given such information, it is possible to calculate kilolux-to-PPFD conversion factors for common light sources:

Table 1 does not include commercial products such as the Sylvania SHP-TS GroLux (with a CCT of 2050 K) because Sylvania and most other lamp manufacturers do not publish their lamp SPDs in tabular form. It is possible to digitize the graphical representations of white light LEDs because the bandwidth of the blue “pump” LEDs is at least 15 nm. With high-pressure

| Light Source | Conversion Factor |
|--------------------------------------|-------------------|
| CIE A (incandescent, 2856 K) | 17.0 |
| CIE 5000K daylight (D50) | 28.5 |
| CIE 5500K daylight (D55) | 28.0 |
| CIE 6500K daylight (D65) | 25.2 |
| CIE 7500K daylight (D75) | 22.8 |
| CIE HP1 (standard HPS, 1959 K) | 3.9 |
| CIE HP2 (color-enhanced HPS, 2506 K) | 13.0 |
| CIE HP3 (metal halide, 3144 K) | 9.2 |
| CIE HP4 (metal halide, 4002 K) | 9.0 |
| CIE HP5 (metal halide, 4039 K) | 13.9 |
| 2700 K white light LED | 16.9 |
| 3000 K white light LED | 18.2 |
| 3500 K white light LED | 17.4 |
| 4000 K white light LED | 17.7 |
| 5000 K white light LED | 14.6 |

sodium and metal halide lamps, however, it is impossible to digitize their published SPDs because the wavelength resolution is unknown. A subnanometer-wide line emission, for example, could vary in height by five times, depending on whether the wavelength binning is 1 nm or 5 nm.

LED Lighting for Horticulture

At this time, high-pressure sodium (HPS) lamps are the most common light source for greenhouse lighting, where it is commonly used to supplement daylight during the winter months. However, with the growing interest in urban horticulture that relies exclusively on electric lighting, light-emitting diodes offer many advantages. This is particularly true for multilayer cultivation, where the close spacing of plants in vertical rack-mounted trays make HPS lighting impractical.

McCree [4] noted that the relative quantum yield for crop plant photosynthesis has two peaks at 440 nm and 620 nm. He also noted however, the Emerson effect, which states that photosynthesis in the presence of two or more wavelengths can be more efficient than the sum of that due to the individual wavelengths. In particular,

adding white or blue light to deep red light can beneficially increase the rate of photosynthesis.

Green light is also used in photosynthesis, as can be seen from the crop action spectrum (Figure 2). It has been established that green light drives photosynthesis more effectively than red or blue light deep within the leaf [8]. Further, the insects used in greenhouses as pollinators and biological control agents see best in the green and ultraviolet regions of the spectrum.

It is likely, for this reason, that many horticultural LED modules feature efficient 450 nm indium-gallium-nitride (InGaN) deep blue LEDs and 660 nm aluminum-indium-gallium phosphide (AlInGaP) deep red LEDs. Typical examples of these LEDs are the Philips Luxeon Royal Blue and Deep Red products [7]. Both of these products are quite efficacious, converting some 45% of their electrical input power into visible light. Green LEDs, while beneficial, are rarely used because of their much lower radiant efficiencies. (This may soon change however, as Osram Opto recently announced the development of 530 nm InGaN green LEDs with 25% external quantum efficiency.)

Herein, however, lies a problem: 450 nm and 660 nm are close to the limits of our color vision (Figure 4). Consequently, Philips and other manufacturers typically express the optical performance of these products in radiometric rather than photometric terms - milliwatts instead of lumens.

So, the lighting design process becomes a bit more complicated. We first need to digitize the published LED spectral power distributions to determine the conversion factors between milliwatts and lumens - these will be needed for the lighting design simulations. These are given by:

$$\Phi_L = 0.683 \cdot \frac{\sum_{400}^{700} \Phi_R(\lambda) V(\lambda)}{\sum_{400}^{700} V(\lambda)}$$

where Φ_L is the luminous flux, $\Phi_R(\lambda)$ is the relative spectral radiant flux and $V(\lambda)$ is the luminous efficiency function at wavelength λ .

Using the Philips Luxeon Royal Blue and Deep Red products as an example, the conversion factors are approximately 0.07 and 0.03 lumens per milliwatt (lm/mW) respectively. However, these figures must be approached with some caution, as they apply to 450 nm and 660 LEDs only. If, for example, the peak wavelength of deep blue LED was 440 nm rather than 450 nm, the conversion factor would be 0.05 lm/mW. Similarly, if the peak wavelength of the deep red LED was 650 nm rather than 660 nm, the conversion factor would be 0.06 lm/mW. The Philips LED binning ranges are 440 to 460 nm and 650 to 670 nm respectively, which equates to (from Figure 4) conversion factor uncertainties of +75%, -50% for blue and +60%, -30% for red. The above conversion factors are therefore decidedly approximate.

(Some horticultural LED module manufacturers bin their LEDs more tightly, as peak maxima shifts as small as 10 nm have been shown to have dramatic effects on plant

Table 1:
Illuminance (kilolux)
to PPFD ($\mu\text{mol}/\text{sec m}^2$)
conversion factors

Figure 5:
Test installation for horticulture lighting
(Credits: Aeon Lighting Technology Inc. - www.aeonlighting.com)

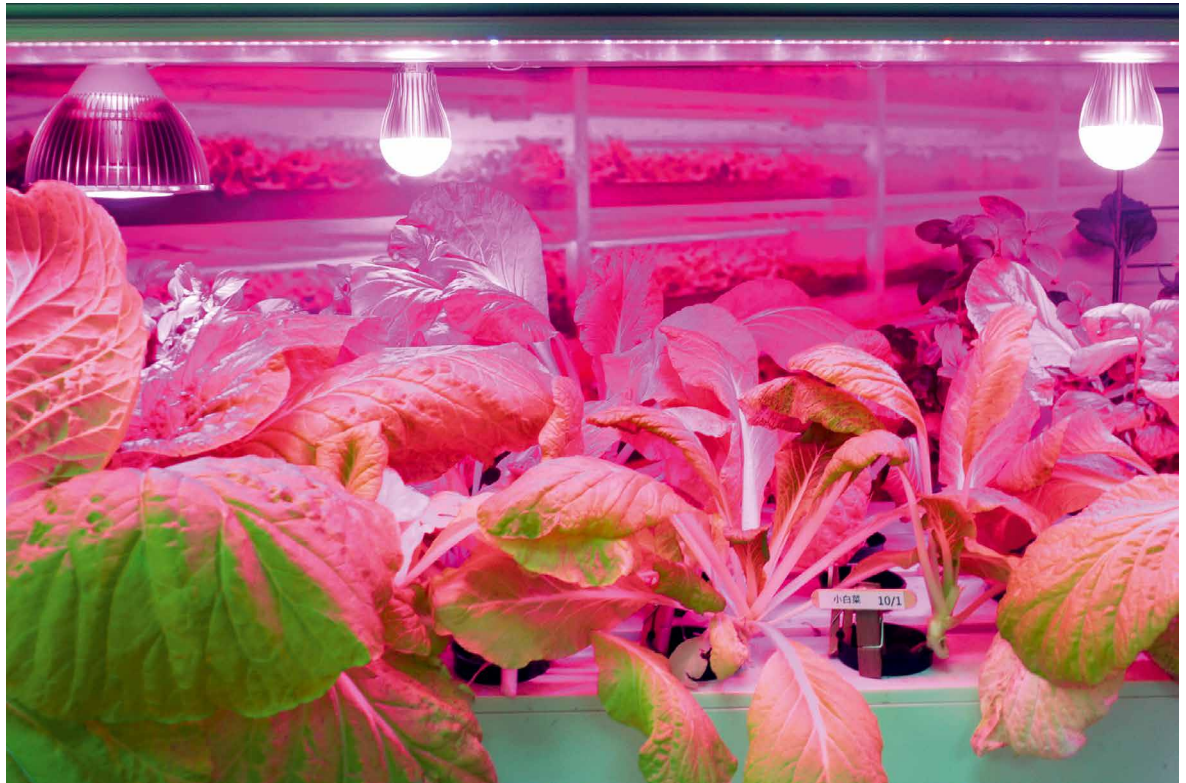

Table 2:
Illuminance (kilolux) to PPF (μmol/sec-m²) conversion factors

growth. However, unless the binning policy is stated in the manufacturer's product literature, this cannot be assumed.)

A further word of caution: even the best illuminance meters can be wildly inaccurate when measuring deep blue and deep red light levels. Commercially available photometers are usually classified according to their f1' number (with f1' < 3% being preferred), which is basically a measure of how closely the spectral response of the meter matches that of the photopic visual efficiency function (Figure 4). As noted in CIE 127:2007, Measurement of LEDs [3], this is useful for white light measurements only. To quote, "In the case of single-color LEDs, the spectral mismatch errors can be very large even if f1' is reasonably small, due to the fact that some LED spectra are peaking in the wings of the V(λ) function where the deviation makes little effects on f1' but can cause large errors."

With these conversion factors in hand, we can now calculate the approximate illuminance-to-PPFD conversion factors for horticultural LEDs:

| Light Source | Conversion Factor |
|----------------------|-------------------|
| 450 nm deep blue LED | 14.3 |
| 525 nm green LED | 1.0 |
| 660 nm deep red LED | 15.6 |

How horticulturalists choose to balance the ratio of red to blue light will likely depend on the specific plant species being cultivated and their stage of growth. Some plants like shade, while others prefer direct sunlight, with different SPD requirements. Regardless, the above conversion factors will still be useful.

In addition to using chlorophylls and carotenoids for photosynthesis, plants use these and other photopigments for a wide variety of functions. The phytochromes Pr and Pfr, for example, respond to 660 nm red and 735 nm infrared radiation respectively, and in doing so induce seed germination and flowering, regulate leaf expansion and stem elongation, and trigger photoperiod and shade avoidance responses.

Other photopigments regulate phototropism (leaf and stem

orientation) and circadian rhythms (for which blue light is the most effective), photomorphogenesis (plant shape), root growth, stomatal opening, chloroplast movement, etc. The list goes on, as horticultural researchers continue to explore the role between lamp SPDs and optimal plant health and growth [iii].

Summary

As a reminder, photosynthetically active radiation (PAR) does not consider the spectral response of plants (Figure 2); it simply represents the number of photons (quanta) per unit area per second within the range of 400 to 700 nm. With the availability of color-tunable LED modules for greenhouse lighting, horticulturalists will likely want to experiment with different SPDs for specific crops and flowering plants, as well as both the directionality and daily timing of the luminaires. Regardless, being able to convert predicted and measured illuminance values to PPF values for common light sources will certainly ease the communication problems between lighting designers and horticulturalists. ■

Notes:

- [i] A mole is a unit of measurement used in chemistry to express the number of elementary entities in a substance that is equal to the number of atoms in 12 grams of the isotope carbon-12. It corresponds to the Avogadro constant, whose value N_A is 6.022×10^{23} particles (in this case photons) per mole. A micromole is one millionth of a mole
- [ii] The quantum yield in photosynthesis is defined as the micromoles of carbon dioxide fixed per micromole of photons absorbed
- [iii] See www.photobiology.info for an informative summary of plant photobiology

References:

- [1] Barnes, C., T. Tibbitts, J. Sager, G. Deitzer, D. Bubenheim, G. Koerner, and B. Bugbee. 1993. "Accuracy of Quantum Sensors Measuring Yield Photon Flux and Photosynthetic Photon Flux," *Horticultural Science* 28(122):1197-1200.
- [2] CIE. 2004. *Colorimetry, Third Edition*. CIE Technical Report 15:2004. Vienna, Austria: Commission Internationale de l'Eclairage.
- [3] CIE. 2007. *Measurement of LEDs, Second Edition*. CIE Technical Report 127:2007. Vienna, Austria: Commission Internationale de l'Eclairage.
- [4] McCree, K. J. 1972. "The Action Spectrum, Absorbance and Quantum Yield of Photosynthesis in Crop Plants," *Agricultural and Forest Meteorology* 9:191-216.
- [5] www.licor.com
- [6] Philips Lumileds. 2014a. *Luxeon Rebel ES Portfolio Datasheet DS61*. Philips Lumileds Lighting Company.
- [7] Philips Lumileds. 2014b. *Luxeon Rebel Color Portfolio Datasheet DS68*. Philips Lumileds Lighting Company.
- [8] Terashima, I., T. Fujita, T. Inoue, W. S. Chow, and R. Oguchi. 2009. "Green Light Drives Leaf Photosynthesis More Efficiently than Red Light in Strong White Light: Revisiting the Enigmatic Question of Why Leaves are Green," *Plant & Cell Physiology* 50(4):684-697.
- [9] Zhu, X.-G., S. P. Long, and D. R. Ort. 2010. "Improving Photosynthetic Efficiency for Greater Yield," *Annual Review of Plant Biology* 61:235-261.



THE GLOBAL LANGUAGE OF LIGHT

NEW YORK, NY USA

Javits Center

PRE-CONFERENCE

May 3 – 4, 2015

TRADE SHOW & CONFERENCE

May 5 – 7, 2015

LIGHTFAIR.COM



IALD



PHOTO CREDITS
(1) WALL ILLUMINATION FANTASY OF PIOLE HIMEJI, HIMEJI-SHI, JAPAN | LIGHTING DESIGN: UCHIHARA CREATIVE LIGHTING DESIGN INC + TAKEKAWA CORPORATION | PHOTOGRAPHY © MASAKI KAWAGUCHI (2) BRANZ KOSHEN, NISHINOMIYA, JAPAN | LIGHTING DESIGN: AKARI+DESIGN ASSOCIATES | PHOTOGRAPHY © HIROYUKI TSUDA

SPECIAL: ENLIGHT PROJECT OUTCOMES



- 68 EnLight - Next Generation Intelligent and Energy Efficient Lighting Systems
by Frank van Tuijl, Philips Lighting
- 72 System Architecture for Distributed Intelligence
by Lex James, Philips Research; Martin Creusen, Philips Lighting; Micha Stalpers, AME
- 80 New Form Factor Luminaires and New Light Effects
by Herbert Weiß & Thomas Noll, Osram; Martin Möck, University of Erlangen-Nuremberg; Martin Creusen, Philips Lighting; Friedhelm Holtz, Insta Elektro
- 86 The Building Blocks for Intelligent Future Luminaires
by Tim Böttcher & Lucie Chandernagor, NXP; Philippe Maugars, PMC; Hannu Vihinen, Helvar; Mark Coopmans, Philips Lighting; Olli-Pekka Jokitalo, PKC Electronics; Raimo Ontero, Valopaa; Christian Paul, Infineon; Rafael Jordan, Fraunhofer IZM
- 92 Peripheral Devices for the Right Light
by Werner Weber, Infineon Technologies; Lex James, Philips Research; Arjan van Velzen, Plugwise; Bruno Vulcano, Legrand; Micha Stalpers, AME; Arend van de Stadt, Eagle Vision Systems; Jens Döge, Fraunhofer IIS/EAS; Wilfried Rabaud, CEA Leti
- 98 Granular Lighting Control Enables Significant Energy Savings with Optimized User Comfort
by Eveliina Juntunen, VTT; Frank van Tuijl, Philips Lighting; Herbert Weiss, Osram; Ambali Talen, Philips Research

Summary

The “LEDification of lighting” has led to breakthroughs in light source efficiency and lifetime. However, the real revolution, the digitization of lighting is yet to come. The EnLight consortium, made up of 27 key players in the lighting market, has been working on developing a next generation lighting solution based on intelligent, networked luminaires for the last three years. Shifting from a centralized control system to a network of intelligent luminaires, the EnLight system enables each individual light source to adjust to the conditions around it based on input for its own sensors and other sensor and control inputs using programmed rules and a modular Plug-and-Play intra-luminaire bus architecture. In pilots, the EnLight solution, with its inherent granular lighting control, has already achieved energy savings from 40% for office to 80% for hospitality, while providing the same or better level of user comfort as today’s leading LED solutions. Fuelling new growth opportunities in LED lighting applications, EnLight will lead in the creation of new lighting solutions that inspire and enable designers in ways conventional lighting never could. ■

THE ENLIGHT PROJECT

The EnLight project ran from 2011 to 2014 and was coordinated by Philips Lighting. In 2014, at the European Nanoelectronics Forum in Cannes, the project received the 2014 Innovation Award from the ECSEL Joint Undertaking.

The project was supported and partially funded by the Public Private Partnership ENIAC JU under the Nanoelectronics Energy Efficiency subprogram and by the respective national agencies. The ENIAC Joint Undertaking (JU) is a public-private partnership on nanoelectronics bringing together the ENIAC member States, the European Union, and AENEAS (an association representing European R&D actors in this field). ■

EnLight Consortium Partners:

- Applied Micro Electronics (AME) B.V.
- Besi Netherlands B.V.
- BJB GmbH & Co KG
- Commissariat à l'énergie atomique et aux énergies alternatives
- Eagle Vision Systems B.V.
- Enel Distribuzione SpA
- Fraunhofer Gesellschaft zur Förderung der angewandten Forschung e.V.
- Helvar Oy Ab
- Infineon Technologies AG
- I-NRG B.V.
- Insta Elektro GmbH
- Legrand France SA
- TNO Nederlandse Organisatie voor Toegepast Natuurwetenschappelijk Onderzoek
- NXP Semiconductors France SAS
- NXP Semiconductors Germany GmbH
- OSRAM GmbH
- Philips Electronics Nederland B.V.
- Philips Lighting B.V.
- PKC Electronics Oy
- Plugwise B.V.
- Rheinisch-Westfälische Technische Hochschule Aachen
- Technische Universiteit Delft
- Technische Universiteit Eindhoven
- There Corporation Ltd.
- Università degli Studi di Perugia
- Valopaa Oy
- VTT Technical Research Centre of Finland



ENLIGHT

Energy efficient & intelligent lighting systems

Consortium Partners:

AME



Your Connection to Light



INSTA



PHILIPS



there.



TU/e



valopaa.



EnLight - Next Generation Intelligent and Energy Efficient Lighting Systems

The “Solid State Lighting Revolution” has given lighting and controls new significance. Research projects have become necessary to explore new opportunities and set free the full potential of the new technology. Perhaps the most extensive research in this direction was performed by the EnLight consortium. Frank van Tuijl from Philips Lighting introduces the project and explains why it was initiated and what the aims were. Furthermore, he provides some background information about the five selected technical articles.

The lighting industry is undergoing a radical transformation, driven by rapid progress in solid-state lighting and semiconductor technologies as well as changing societal needs for sustainability, improved energy efficiency and CO₂ reduction. To serve the latest business requirements and drive R&D, these changes need to happen quickly and take place in an open-innovation ecosystem [1].

Recent advancements in solid state lighting (LED), the “LEDification of lighting”, have led to breakthroughs in light source efficiency and lifetime. However, the real revolution, the digitization of lighting is yet to come and will involve a paradigm shift from a lighting component approach to an application centric approach [2].

To achieve this, a consortium of 27 leading European companies and academic institutions have been working together on the project [3], a pre-competitive three-year ENIAC-JU R&D program to develop technology breakthroughs for energy-efficient and intelligent LED lighting solutions. Partners include a number of leading European companies in the lighting industry (including Philips and Osram), the semiconductors industry (NXP and Infineon) and the lighting controls industry (including Insta and Legrand), plus universities and research centers from across the semiconductor and lighting value chain.

Energy Saving through Intelligence

The main goal of the project was to exploit the full potential of solid-state lighting through breakthrough innovations on non-conventional, energy efficient, intelligent lighting systems beyond today’s common lighting control applications. The aim was to achieve 40% energy reduction compared to today’s LED retrofit systems.

The project had three technical objectives:

- Optimized LED lighting modules: Improved optical design, thermal management, driver integration and realization of a communication interface
- Future, non-conventional luminaires: Allowing for freedom of design, integration of novel features, architectural flexibility and serviceability, unrestricted by retrofit solution constraints
- Intelligent lighting systems: Providing means for data mining, smart sensors, sensor fusion and interfacing with Building Management Systems (BMS)

EnLight explored next generation intelligent lighting systems, with the goal of improving light source

energy efficiency (i.e. electrical efficiency of LED drivers and power supplies, optical efficiency and thermal efficiency) and control system intelligence to provide the right light, in the right amount, at the right place and at the right time.

As a “Green Field Approach”, the project addressed the second solid state lighting (SSL) transition wave, overcoming restrictions of legacy technology and infrastructure. The project examined the integration of electronics and controls into luminaires, with a focus on optimal utilization and integration of LEDs, optics, sensors and heat management systems.

The goal was not just to improve efficiency through reduction of the junction temperature and improved light output ratios [4] but to take a next step towards the shape and functional integration of the luminaire, breaking completely free from the conventional form factors associated with traditional lighting. The notion of a luminaire was taken much farther than could be imagined with traditional light sources. In this respect, the objectives are clearly beyond those of the Zhaga program, which focuses on the standardization of mechanical, electrical and thermal interfaces on the components level.

And finally, a third digitalization wave is associated with controls and sensors, which may be part of the luminaire and make the luminaire ready for the Internet of Everything.

Breakthrough Innovations

Breakthrough innovations in the following areas were achieved, taking a disruptive step into the future of lighting.

Distributed intelligence

Inspired by the Internet-of-Things, the project partners explored a novel distributed rules-based intelligence system allowing each individual luminaire to make lighting decisions based on presence, occupancy events or ambient light information detected by its own integrated sensors, or events and information from other nodes in the network (sensor, luminaire or user control). To enable this, a few additional Zigbee cluster libraries were defined.

Distributed intelligence enables deep energy savings with optimal user centered comfort. Without the need of a central controller, it reduces installation and commissioning effort and increases robustness, flexibility & scalability

over lifetime. The inter-luminaire architecture is described in the article “Lighting System Architecture for Distributed Intelligent”.

Digital modular luminaire architecture

A novel Plug-and-Play intra-luminaire bus architecture and communication protocol was created that allows the development and management of a portfolio of re-usable and easily exchangeable luminaire building blocks. The intra-luminaire communication bus is built on an I²C physical layer, using ILB as the communication protocol. The building blocks include LED light engines, embedded sensors, high- and low-power supplies, and embedded controllers. The modular approach makes it easier to manage the diversity and complexity of luminaires throughout the supply chain, decouples lifecycles of independent modules/technologies and enables market players to contribute, differentiate and compete. The “Lighting System Architecture for Distributed Intelligent” and “The Building Blocks for Intelligent Future Luminaires” articles describe the intra-luminaire architecture and the modular building blocks.

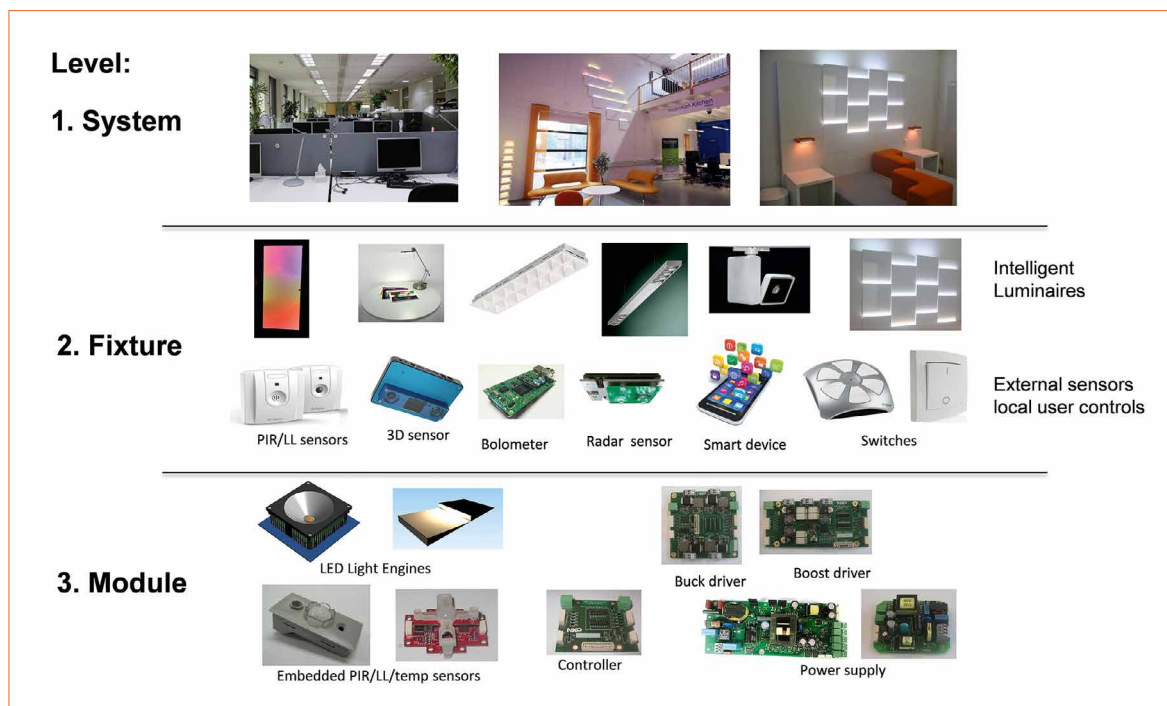

Figure 1: System hierarchy and building blocks

Figure 2:
Office and hospitality demonstrations
(from left to right:
Office demonstration - Philips;
office demonstration - VTT;
hospitality demonstration - Osram)



Technical Highlights

The consortium partners developed EnLight-compatible building blocks at module, fixture and system level as illustrated in figure 1. These contributions included modules, intelligent luminaire and external sensors and local user controls.

Modules

Specific technologic innovations included compact multi-channel LED drivers and power supplies with high electrical efficiencies (up to 90-95%) over the whole dimming range, electronic designs for low standby power, compact embedded sensors (ambient light, occupancy, ambient temperature), LED light engine designs for high LOR (Light Output Ratio, up to 90%) and high thermal efficiency.

Intelligent luminaires

Philips contributed the (mini)-PowerBalance and TaskFlex intelligent luminaires as the lead carrier platform for this development. The PowerBalance luminaires were equipped with 4-channel LED strings for tunable white applications and the combined PIR/light level/temperature multi-sensor.

Osram developed an extendable RGBW decorative tile concept and novel luminous door concept, while Insta contributed the Glow, a suspended intelligent luminaire with both task and ambient light. The “New Form Factor Luminaires and New Light Effects” article gives an introduction into the novel luminaire concepts.

All luminaire types were built from the same plug-and-play building blocks developed in the project,

showing that with only a limited set of intra-luminaire modules, a large variety of luminaires can be constructed across different module suppliers and luminaire makers. The building blocks are described in the “The Building Blocks for Intelligent Future Luminaires” article.

External sensors and local user controls

At fixture level System-on-Chip (SoC) implementations for advanced and cost effective image and radar sensors for reliable occupancy, presence and activity detection were developed by several academic and SME partners (University Perugia, Institutes TNO, Fraunhofer-EAS, CEA-Leti and SME Eagle Vision). External sensors and user controls were developed by Plugwise, AME and Legrand. They are described in the “Peripheral Devices for the Right Light” article.

System Demonstrations

Three system demonstration pilots in the office and hospitality application domains were realized at three different locations (Figure 2), each using 60-120 EnLight compliant ZigBee nodes (intelligent luminaires, external sensors or user control) without any central controller.

Sophisticated energy saving strategies were demonstrated, such as task tuning, personal control, occupancy control and daylight harvesting. As both embedded sensors and external sensors provide information to the luminaires, granular control strategies have been tested centered around users using light bubbles, local daylight

regulation and personal control with smart integrated desk lights. Comfort enhancing features using tunable white and colors were also demonstrated including circadian rhythm in the open office and scene settings with ambient colors to support activities in the meeting room.

Validation of energy efficiency and user comfort results

For evaluation, the Lighting Energy Numeric Indicator (LENI) described in standard EN 15193 was used: Energy performance of buildings - Energy requirements for lighting as the indicator of the energy performance. This measures the actual annual energy consumption of the lighting system (in kWh/m² per year) taking into account the installed power of the luminaires, the lighting controls strategy and system parasitic power.

The results from the three representative office and hospitality pilots realized in the project confirmed significant energy savings of between 44% and 81% compared to current LED retrofit applications with a standard room occupancy-based control strategy.

The office pilot demonstrated overall energy savings of 44% with an average contribution from the sophisticated granular control strategy of 30% and an overall lumen efficacy improvement of 20%.

The hospitality pilot demonstrated even larger overall energy savings of 81%, with a 67% average contribution from the control strategy and 42% from luminaire efficacy improvement. The large difference between the office and hospitality results was

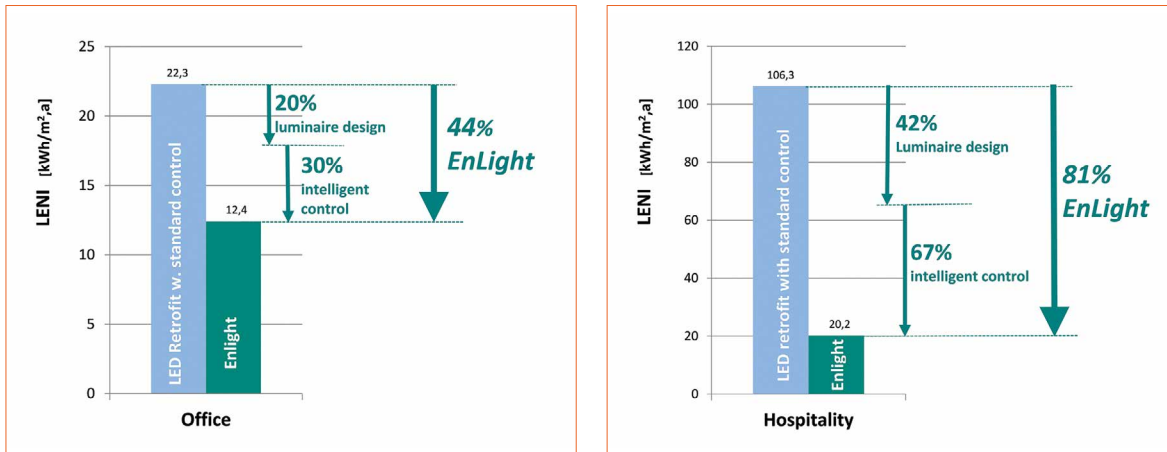

Figure 3:
Energy saving results
for office (left) and
hospitality (right)
demonstrations

due to the higher lighting power density, lower occupancy and use of decorative but less efficient luminaires in the hospitality application.

As the resulting energy saving for the total installation for each of the pilots was more than the targeted 40%, the primary challenge of the project was accomplished.

From a lighting comfort perspective, based on key lighting parameters such as lighting quality, brightness (glare) and room appearance, the new developed system delivered a comparable performance with respect to reference non-retrofit LED lighting installations. While significant differences in lighting comfort were not statistically proven, qualitative analysis results showed an 80% preference for the EnLight system over a state-of-the-art LED reference system.

The LENI energy values measured overall for office are 12.4 kWh/m² per year compared to 20.4 kWh/m²

per year for the LED retrofit baseline. These results amply exceed the best in class scores of the building energy performance benchmarks (i.e. EN 15193 [5], ASRAE [6], Title 24 [7]) and score the maximum of LEED [8] credit points. The hospitality installation surpassed even green building performance norms with a 45% better saving performance (20.2 kWh/m² per year).

The energy efficiency and user validation results are described in the “Granular Lighting Control Enables Significant Energy Savings with Optimized User Comfort” article.

The Road Ahead

EnLight developed a novel, decentralized and modular system architecture for next generation intelligent lighting systems, empowering the next generation smart lighting systems.

Driven by granular control strategies, the new system demonstrated significant energy

savings without compromising and even improving light quality and user comfort. The substantial additional energy savings for lighting will lead to a reduction of global CO₂ emission. This is an important step to meet the EU directive 2010/31/EU for a near zero energy building performance in 2020.

By building on Europe’s leadership in semiconductor and lighting technology and exploring future ecosystems featuring the intra-luminaire bus and decentralized rule-based intelligence, this new concept is helping shape the lighting market for the coming years. It enables new lighting solutions that were not possible with conventional lighting technology.

This creates opportunities both for large companies and SMEs. Fuelling new growth opportunities in LED Lighting applications, this project will lead to the creation of new lighting solutions that inspire and enable designers in ways conventional lighting never could. ■

References:

- [1] http://www.eniac.eu/web/downloads/projectprofiles/call3_enlight.pdf
- [2] Dr. Kees van der Klauw: „The Paradigm Shift in Lighting” ISS Europe 2013, Milan (2013)
- [3] EnLight: <http://www.enlight-project.eu>
- [4] The ratio of luminous flux emitted by the LED light source and that emitted by the entire luminaire system.
- [5] EN 15193:2007 Energy performance of buildings - Energy requirements for lighting
- [6] ANSI/ASHRAE/IES Standard 90.1-2007
- [7] <http://www.energy.ca.gov/2012publications/CEC-400-2012-004/CEC-400-2012-004-CMF-REV2.pdf>
- [8] Leadership in Energy and Environmental Design (LEED)

System Architecture for Distributed Intelligence

The usage of intelligence and sensors is not totally new, but solid-state lighting has brought it to a new level that has led to a new way of thinking about system architecture. The EnLight project found the distributed intelligence approach to be the preferable solution. Lex James from Philips Research, Martin Creusen from Philips Lighting, and Micha Stalpers from AME explain the reasons why, what the system architecture for distributed intelligence looks like, and how it works.

System architecture is about partitioning a system into its components and defining the relationships between those components. In general, it is good practice to partition a system so that the components are loosely coupled and have few dependencies while still maintaining the cohesion of the system as a whole. The notion of “separation-of-concerns” should be leading in any system architecture.

This is certainly true for the EnLight project which introduces a paradigm shift in lighting control by applying the “publish-subscribe” design pattern, appreciated both for its scalability and loose coupling. In such a lighting system, sensors inform luminaires instead of controlling them. As a result, the publisher (e.g. sensor) does not need any knowledge of its subscribers (e.g. luminaires). It just delivers its event to any subscribed device. This makes the publisher subscriber-agnostic, but what if the subscriber could also be publisher-agnostic too?

To achieve this objective, a second architectural choice is needed: every subscriber needs to be equipped with a decision engine that can be programmed

with rules. The rules specify how each subscriber acts when it receives an event. So the rules have a dependency with the publisher rather than the decision engine itself.

The third important architecture choice for this project is closely related to the economy of scale of luminaire manufacturing. The concept of an Intra Luminaire Bus (ILB) allows luminaire manufacturers to build a large variety of luminaires from standardized HW/SW modules.

Since it would be impossible to address the complete EnLight system architecture in this article, the following three key topics have been selected. The chapter on system hierarchy addresses the various control levels of the system. The area level communication section describes the communication protocol that implements the “publish-subscribe” pattern. The third chapter covers the intelligent luminaire which acts as both a subscriber (light sources) and a publisher (embedded sensors). Due to the decentralized nature of the architecture, the intelligent luminaire is the cornerstone of the new developed lighting system.

System Hierarchy

Four distinct aggregation levels make up the EnLight architecture, as shown in figure 1. The project focused on luminaire and area levels, together with the corresponding intra- and inter-luminaire communication technologies. Building and enterprise, the two higher aggregation levels, are also supported by the new architecture (for example, to release information from the lighting system to the building management system).

The decentralized architecture is based on distribution of information rather than controlling individual luminaires via a centralized control unit. Thus “events” generated by sensors are distributed across the whole network. Thereafter each luminaire decides autonomously, according to its own embedded rules, how to control its lighting function based on notified events. So, decision making is made at the lowest aggregation level instead of in the centralized control unit.

Another key architecture element is the decoupling of the lighting domain from adjacent domains. Sensors report events without knowing the type of subscribed luminaires. Therefore, events are not interpreted or prioritized by the distributing sensor. This yields a transparent architecture with a

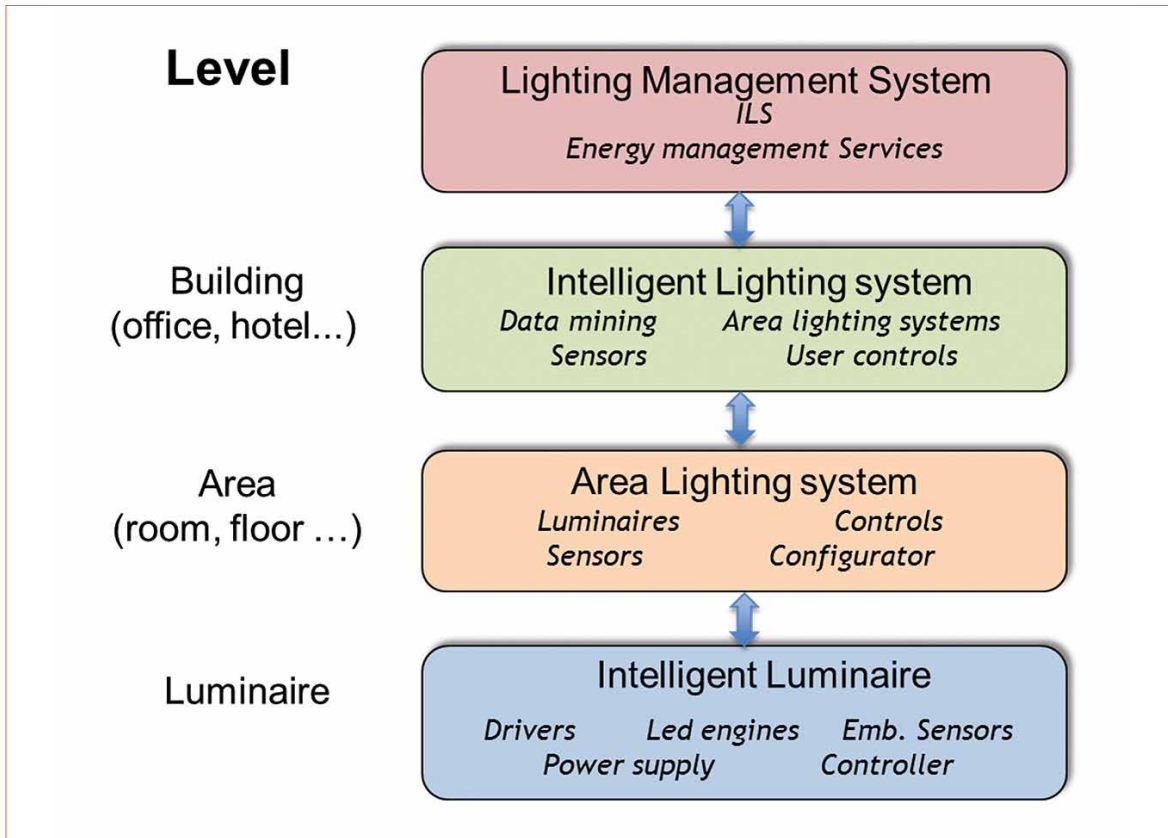

Figure 1: Levels of lighting control

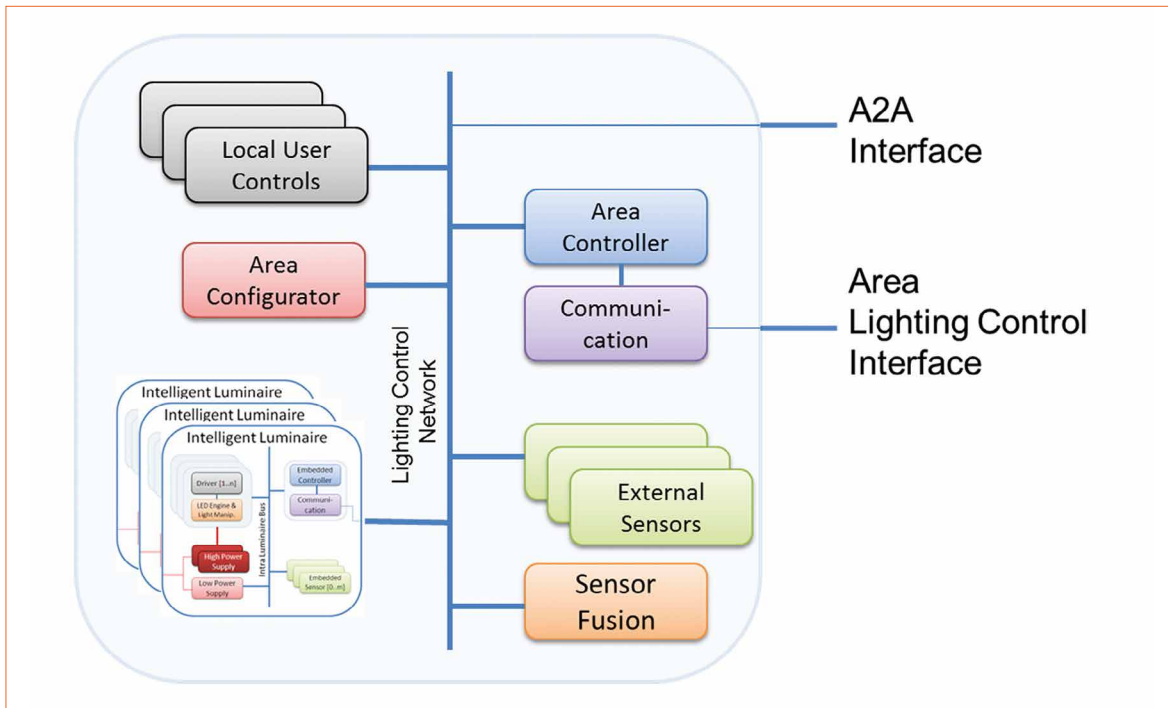

Figure 2: Area lighting system

clear division of responsibilities in which the behavior of the main building block, the intelligent luminaire, is determined by the rules configuration - which can be easily adapted to a changing building environment. Additionally, self-learning algorithms would typically be accommodated by the intelligent luminaire.

In principle, any external device that can generate an event is capable of informing luminaires and therefore interacting with the lighting system. The event source does not require any upfront knowledge of the luminaires, enabling a smooth integration with building management systems.

On the Area level, the lighting control network connects the intelligent luminaires and key components, such as local user controls and external sensors (Figure 2).

The Area configurator enables the configuration of these components simply by changing the rules-based

logic of the intelligent luminaires. Optionally, events generated by multiple external area level sensors can be aggregated and processed using the Sensor Fusion function to reduce the network's overall communication load.

For monitoring or logging functions, the area controller and communication unit can send information from the area network to the higher building level and vice versa. Furthermore, the area controller can transfer events generated at different network levels. Finally, the area controller can also propose a certain light control function, such as an orchestrated color change, at the area level.

In the final EnLight demonstrations, the lighting control network was based on wireless ZigBee technology, as this ensures a scalable low power and low cost implementation. Wired implementations are also possible, but were not implemented in the demonstrations.

The main objective of the project was to develop a lighting system that offers excellent user comfort at the lowest possible energy consumption. This requires the right light to be generated in the right place at the right time. This was achieved by adopting granular sensing and control in a connected lighting system.

Granular sensing ensures, for example, uninterrupted luminaire operation during network interruptions. Granular control comes from embedding most of the decision logic in the luminaires, instead of using a centralized controller to send commands to individual luminaires. The luminaire is intelligent because it autonomously controls its own light sources. Thus the lighting system is effectively a collection of connected and cooperating intelligent luminaires which are able to adapt to changes in the environment.

Area Level Communication

Communication between devices within an area plays a prominent role in the EnLight architecture. It is designed to run on top of existing communication standards like ZigBee and/or IP and to support scalability and flexibility of the lighting system. The communication function is implemented as a set of reusable modules to guarantee consistency and facilitate ease of integration.

Communication protocol

The communication protocol is designed in such a way that new sensors and luminaires can be added to the area network while other devices remain operational. System intelligence, in the form of rules, can be configured and simulated off-line. Offering intelligence by configuration is a key element of decentralized systems and accommodates the system with a number of unique properties.

Figure 3:
Example of including a new sensor in the area network

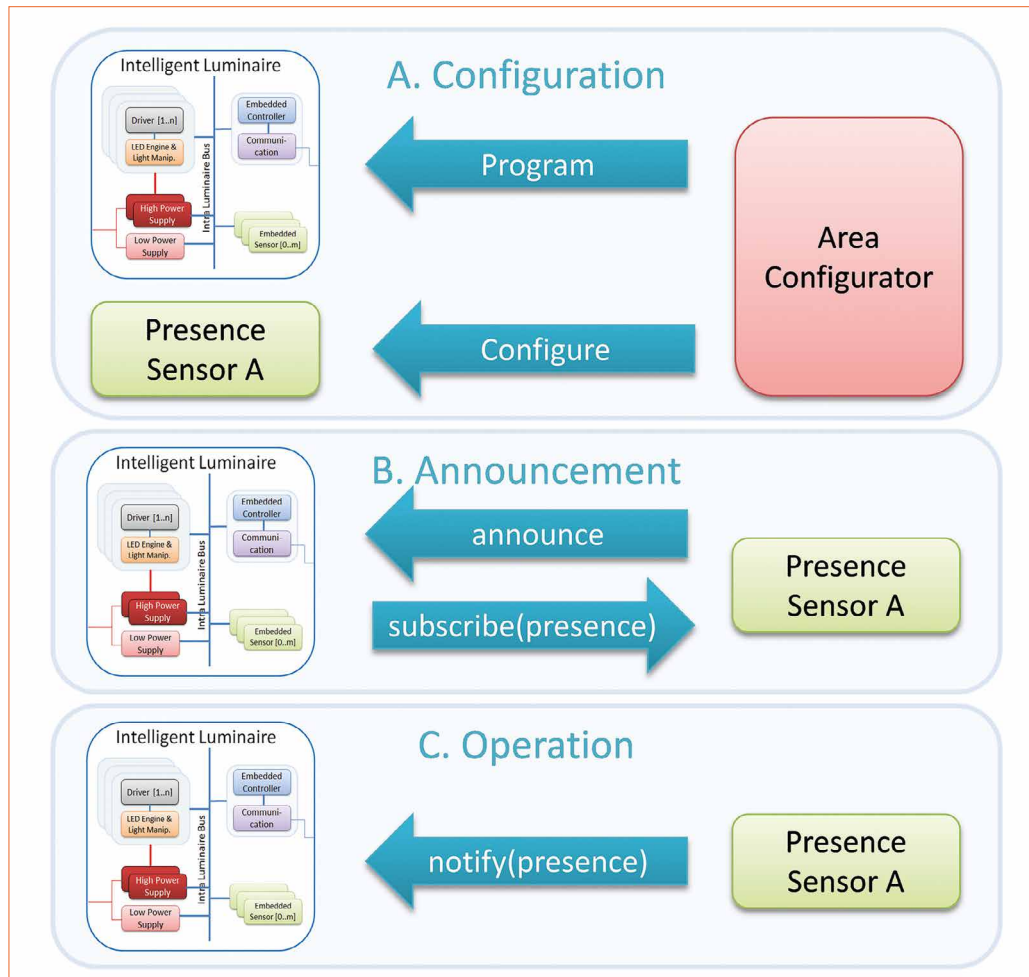

- In a building environment, new sensors can be installed and put into operation without needing to take the whole system offline. Luminaires requiring sensor input for their decisions can be easily updated with new rules in just a few seconds.
- Once installed, new luminaires can be quickly put into operation by connecting the power and providing them with their initial rules.
- All EnLight devices are interconnected - there is no dependency on a physical topology. This allows unlimited intelligence reconfiguration simply by providing the luminaire with new rules. Reconfiguring an area with 40 luminaires only takes a few minutes.
- Reconfiguration of a single sensor, luminaire or part of the system is possible without impacting the rest of the system.
- As the impact on uptime is very limited, automation of the reconfiguration process is possible allowing for self-learning capabilities.

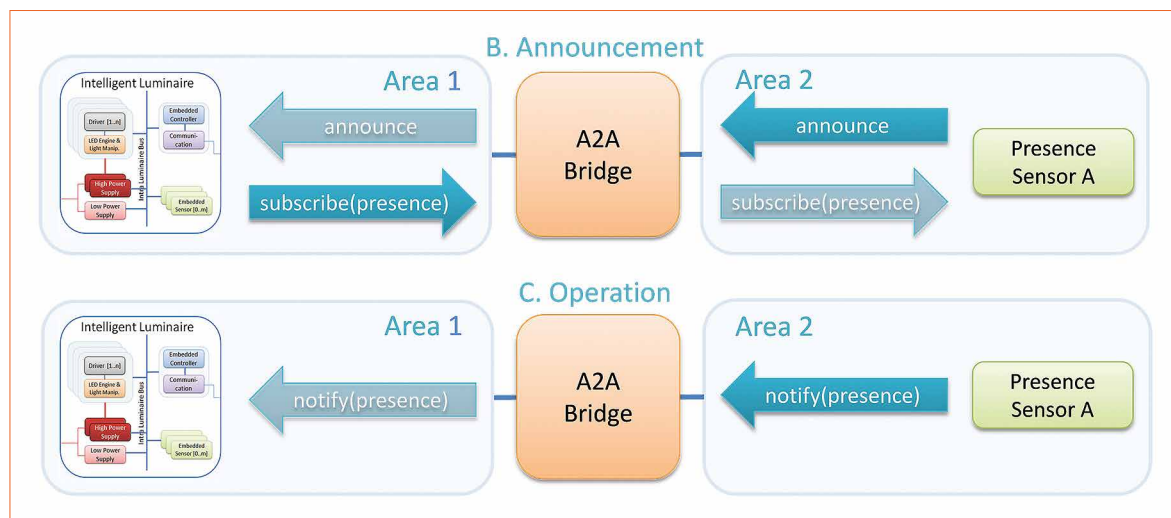

Figure 4:
Example of a bridge
interconnecting two
area networks

The communication protocol is best explained by the example outlined in figure 3 where sensor A is newly added to the system. First the area configurator configures the sensor by sending one or more parameters (e.g. absence delay). Since the sensor is new, the area configurator will also program one or more rules into the luminaires telling them how to respond to events from the sensor.

After configuration, the sensor announces itself to the network. Announcing is typically initiated by a button press or internal timer. When receiving the announcement, each intelligent luminaire checks the occurrence of the sensor in its rules. If it is found, the luminaire sends a subscription request. As a result the sensor adds the luminaire to its subscription list.

After subscription, the newly added sensor is now operational within the area network. As soon as the sensor detects something of interest, it sends an event message to all devices in its subscription list. Each luminaire receiving an event that matches one (or more) of its rules will execute the associated actions. More details are given in the next section.

The protocol separates the sensor domain from the luminaire domain. Devices other than luminaires can send events without adding lighting-specific details. They can also subscribe to events for monitoring and analysis.

Information provided by the system can be valuable in determining energy saving strategies. Examples are “heat maps” of occupancy information and daylight measurements.

Bridging areas

The Area-to-Area (A2A) bridge has been developed to interconnect networks. The bridge can connect networks based on different communication technologies (e.g. ZigBee to IP bridge) but can also be used to scale a network to any size independent of communication-technology constraints. The bridge acts as proxy for devices on other networks and is therefore invisible for the light designer.

Figure 4 outlines how the bridge interconnects two area networks for a presence sensor and an intelligent luminaire programmed to respond to the sensor’s events.

As described previously, including devices in the network and device configuration is performed locally at area network level. The protocol was designed to allow inter-area communication for announcement and operation by making a distinction between a message’s local source and its origin in the system.

Communication framework

The communication framework was developed with three objectives in mind: ensure a consistent protocol

implementation across devices from multiple partners, ease integration and minimize development effort. The framework provides the “glue” between an EnLight C-API and the EnLight binary protocol. It enforces a clear separation between application development and communication technology.

When an instruction from the C-API is invoked, the framework encodes a message containing the corresponding command and sends this to a given target device in the network, identified by a unique 8-byte device ID. It assumes the existence of basic communication operations “send” and “receive” for a particular technology. It also converts device IDs to technology-specific network addresses, such as ZigBee short IDs or internet IP addresses. The response received from the target device is decoded by the framework and results in the corresponding API callback to the application.

The main benefit of this framework approach is that the complex communication layer is made available to application builders via a simple interface without needing to know all the details underneath.

The ZigBee technology layer was implemented for a Windows environment using a ZigBee dongle, with a number of sensors running on an EM250 (Silicon Labs) and the luminaire running on a JN5168 (NXP). For security, the Common Security

Figure 5:
Communication
framework layering

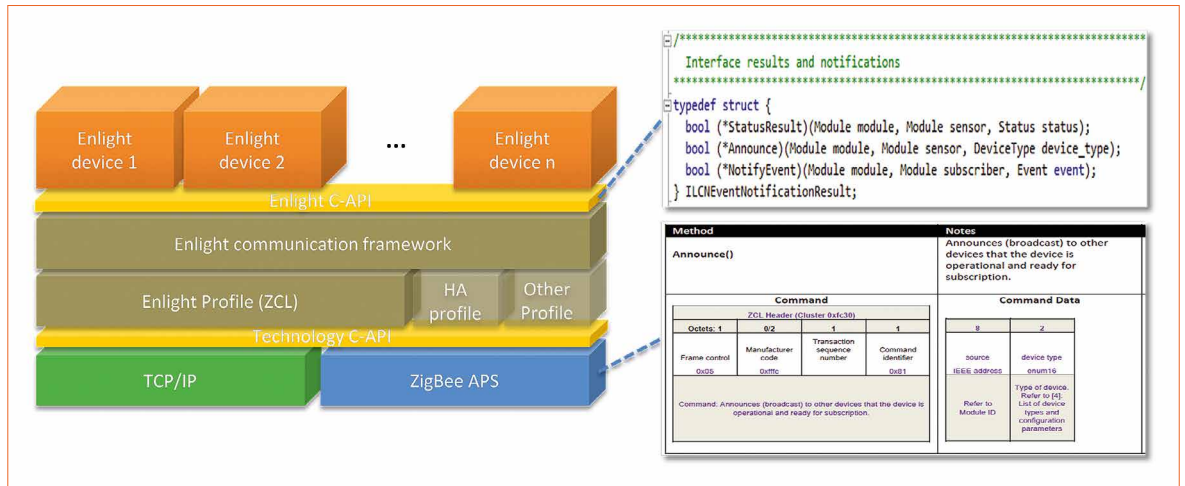

Model with a predefined link key was used. Conforming to the ZigBee cluster library format, EnLight’s ZigBee implementation can coexist with other ZigBee profiles such as home automation.

Interface details

The communication framework offers a set of interfaces that can be regarded as clusters of commands which will be described individually.

The device configuration interface offers run-time configuration of sensor and luminaire parameters in an operational system. To avoid inconsistencies during configuration, the configuration start and end are explicitly communicated. Getting and setting device parameters is based on key-value pairs. Moreover, the list of parameters supported by a particular device can be requested, and only the Area Configurator requires knowledge

of these parameters. This allows a particular device’s parameters to be extended without any impact on the protocol structure.

The programming interface offers run-time configuration of the luminaire intelligence. The rules are encoded into a compact binary format and transmitted to the luminaires in packets.

The event subscription interface is typically implemented by (but not limited to) a sensor device to allow other devices to subscribe to its events. It also allows other networked devices to request a sensor device to announce itself, enforcing announcement after system reconfiguration. The intelligent luminaire uses the interface to subscribe to sensor events. The notification command is used to inform other devices of an event.

Table 1:
Device configuration
interface

| Method | Notes |
|----------------------|---|
| StartConfiguration() | Starts configuration of the device |
| GetParameterList() | Returns the list of parameter identifiers the device supports |
| GetParameter() | Returns the value of a parameter, gives its identifier |
| SetParameter() | Sets the value of the parameter with the given identifier |
| EndConfiguration() | Signals that configuration of the device is complete |

Table 2:
Programming rules
interface

| Method | Notes |
|--------------------|--|
| StartProgramming() | Starts programming of rules for the device |
| AddRuleFragment() | Adds (a fragment of) a new rule for the device |
| EndProgramming() | Ends programming of rules for the device |

Table 3:
Event subscription &
notification interface

| Method | Notes |
|------------------------|---|
| SubscribeToEvent() | Subscribes to the given event of this device |
| UnsubscribeFromEvent() | Unsubscribes from the given event of this device |
| RequestToAnnounce() | Request a device to announce itself |
| Announce() | Announces that the device is operational and ready for subscription |
| NotifyEvent() | Notifies the occurrence of an event to the subscribers |

Intelligent Luminaire

Luminaire architecture

There are diverse contemporary luminaire designs across various, regionally different lighting market segments. A main architectural question is therefore how to manage such a scattered mass-volume market cost-effectively. To avoid specific (low volume) peak designs, with relatively high development and bill-of-material (BOM) cost, common modules and standardized interfaces need to be (re-)defined as the lighting industry has always

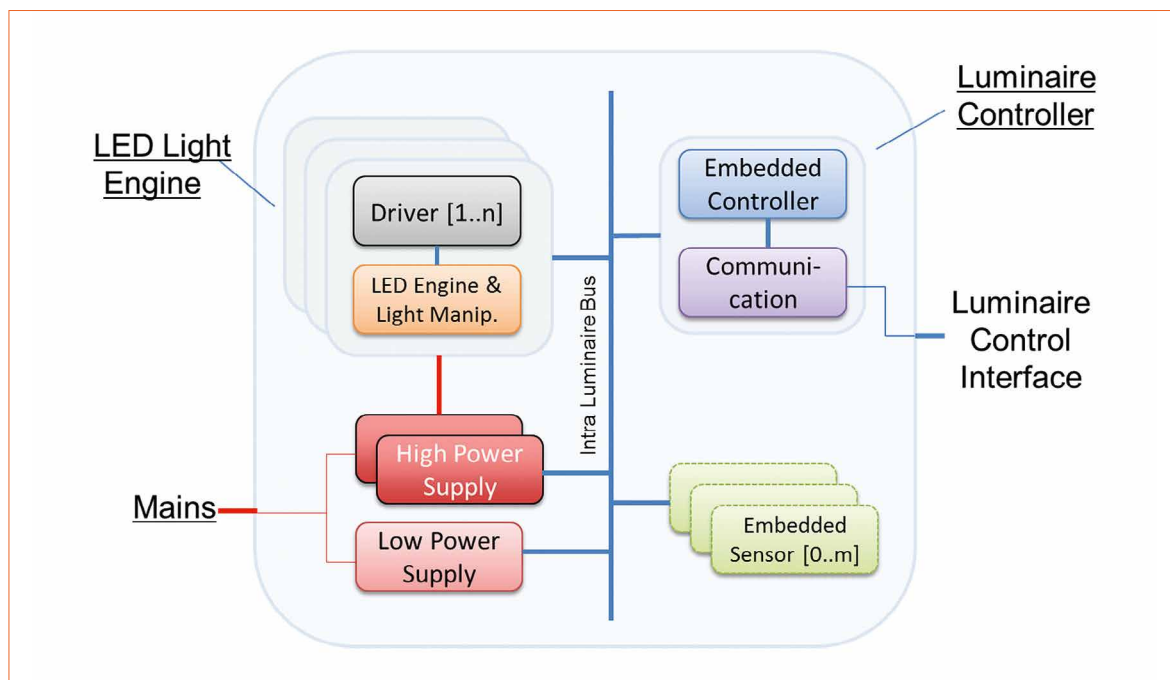

Figure 6:
Modular luminaire
block diagram

been based on standardized light sources and interfaces (e.g. E27, E14, GU10, etc.).

To date, standardized interfaces for LED-based light sources have been scarce. However, the global lighting consortium, Zhaga, published its first interchangeability standards in 2012. Zhaga standards focus on non-competitive aspects of the main interfaces, ensuring sufficient design freedom to differentiate and compete. This will lower the adoption hurdle for LED design-ins and further fuel the LED-based lighting industry.

The EnLight luminaire architecture uses an I²C-bus interface to interconnect embedded components, allowing partners to contribute their technologies. The resulting modular, Plug-and-Play architecture facilitates future luminaire upgrades. It also enables 'late stage' luminaire configuration, either during production or installation. Finally, an easy, exchangeable modular concept reduces potential cost-of-non-quality, and decouples the lifecycles of independent technologies. The schematic diagram in figure 6 depicts the components of the architecture's key building block: the intelligent luminaire.

The different functions in the diagram can be either integrated or stand-alone, as preferred. For example, it is possible to combine the driver and LED engine, or the embedded controller and LED engine. The distributed power architecture uses centralized high- and low-power supply units, supplying 24 V DC (i.e. SELV) to the LED modules and drivers (optionally, the 24 V DC supply can also be used for power-demanding embedded sensors), and 5 V for the communication bus. It centralizes the power factor control and harmonic distortion circuits, and ensures low voltage Plug-and-Play operation for the luminaire's other key components. This reduces design complexity significantly, especially in multi LED Light Engine (LLE) luminaires.

Embedded sensors, such as temperature, light level or absence sensors, increase control effectiveness as they are typically co-located with the luminaire. This also simplifies installation and commissioning.

The embedded controller implements the decision engine and logical luminaire. The communication module connects the embedded controller to the 'Lighting Control Network' (LCN).

LED light engine

The LLE actually produces the light and is thus the module with the largest diversity. In a full color luminaire like the Wedge, the LED engine differs significantly from the single channel LLE used in the TaskFlex. The LLE's key functions are depicted in figure 7.

The color generation module calculates the individual primary colors intensity to realize the closest color possible. Because some applications require slow color transitions combined with a fast response to brightness changes, the LLE has a separate brightness and color fader.

Embedded controller

LLEs and Embedded Sensors need a controller to bring the luminaire to life. From a software perspective the controller is the most complex module. Fortunately, all EnLight luminaires share the same controller software, so development cost can be spread over many luminaires.

The "Decision Engine" is the embedded controller's brain and the attached memory contains a set of rules which determine the luminaire's behavior. Rules are programmed over the "Luminaire Control Interface" and stored in persistent memory.

Figure 7:
LED light engine block diagram

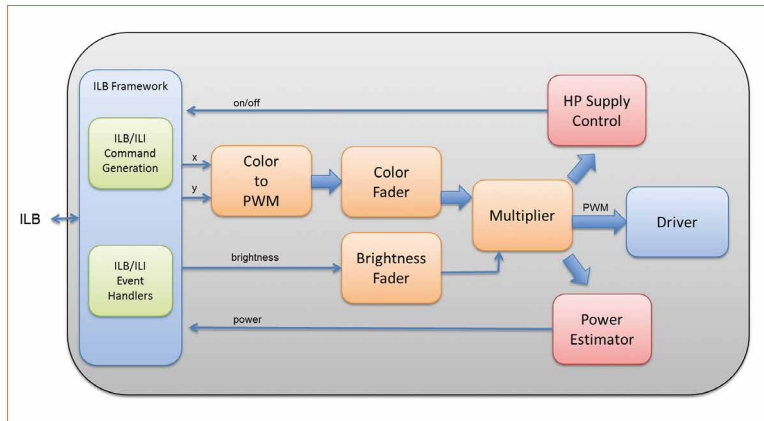

Figure 8:
Embedded controller block diagram

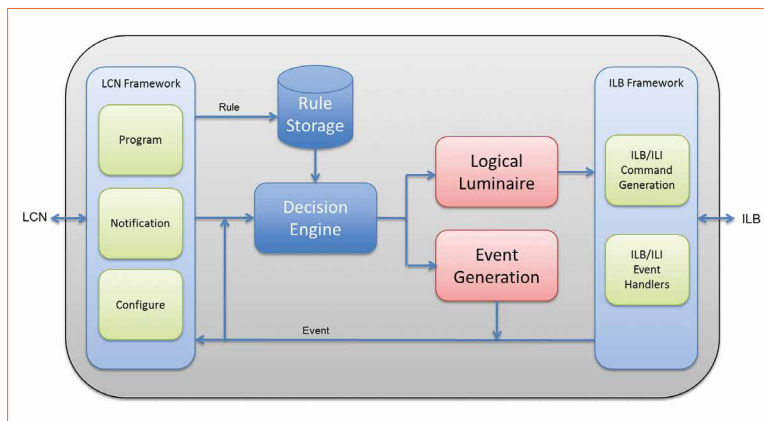

Table 4:
Rule actions
(some actions require arguments, comprising the event's parameters and variables - Figure 9)

| Action | Explanation |
|------------------|--|
| LevelActivation | Activates or deactivates a priority level |
| SetVariable | Set the content of a variable |
| LuminaireSetting | Change a light setting of a LED Light Engine |
| SetTime | Set the local time of the luminaire |
| GenerateEvent | Generate an event |

Table 5:
Luminaire commands

| Luminaire Setting | Explanation |
|----------------------|---|
| On | Switch the light on |
| Off | Switch the light off |
| SetColor | Set the color |
| SetBrightness | Set the dimming level |
| ActivatePreset | Apply the settings according to the specified presets |
| SetLightLevelControl | (De-)activate the closed loop light level control |
| SetColorFadeTime | Set the time to go from one color to the other |
| SetFadeTime | Set the time to go from one dim level to the other |
| SetPowerMode | Set the high power supply mode: on, off or auto |

The decision engine can be triggered by both internal (ILB) and external events (LCN). Each time an event is received all the decision engine's rules are evaluated, and if a rule is triggered one or more actions

are executed. Typically, an action results in a luminaire command that is passed to the logical luminaire. This component translates a luminaire command into ILB messages to control the LLEs.

Decision engine & rules

In general there are two methods for implementing decision logic: scripting or rules. The consortium chose a rule-based solution as most lighting scenarios map well onto rules. Rules are also simple and inherently parallel, so lighting designers are not forced into the sequential thinking of programmers. The decision engine evaluates rules upon receiving an event. Rules are kept relatively simple to allow implementation on low cost hardware. While specified in XML, rules are programmed and stored in binary format and consist of three parts: Trigger Event, Condition and Action(s). The Trigger Event specifies the event (type and source address) that will trigger the rule. If an event matches the rule's trigger event, its condition is tested; if true the specified actions are executed. Table 4 lists the supported actions.

Logical luminaire

The logical luminaire understands "priority levels", with all settings applied on a certain priority level. New settings only become visible if the specified level is activated. If more priority levels are active simultaneously, the highest level settings will be used. The level concept offers a powerful means to prioritize conflicting settings. The "LevelActivation" action is used to activate or deactivate priority levels. As shown in the example (Figure 9), a level's activation can have a timeout and when the timer expires, the level returns to its original state. This feature is often used to make rules more robust for temporary communication flaws.

The most important luminaire commands are listed in table 5.

The "SetLightLevelControl" command activates the 'closed loop light level control', often used for daylight harvesting. The luminaire will try to realize the specified amount of light as measured by the light level sensor.

The logical luminaire also takes care of presets and "Level Definitions", which can be configured and stored

in persistent memory. Presets define each LLE's brightness, color and on/off state, and can be recalled with the "ActivatePreset" command. Similar to a preset, Level Definitions allow default luminaire settings to be overridden at power-on.

Event generation

A luminaire can generate its own virtual events and the generic implementation of this feature makes it very powerful. Events can be generated instantly or after a specified time. This effectively implements a one shot timer, commonly used in lighting applications. For scheduled events, which require an absolute time and date, the luminaire's real time clock ensures the event occurs at the correct time. Finally, the event module can be configured to generate events on a periodic basis.

Key specifications:

- Local rule based engine, up to 250 rules
- Up to 250 presets
- Color control: CCT, xy, HSV, RGB
- Up to 16 priority levels
- Embedded sensors: PIR / Light Level / Temperature / Switch
- Closed loop light level control

Conclusions

The consortium was a unique collaboration with partners and, sometimes, competitors. The following conclusions are based on scientific and technical results. Commercial feasibility has not been addressed and is not taken into account in the conclusions.



Figure 9: XML presentation of a rule - The event "SceneSelected" is generated by a 6 button panel. The event comes with one parameter representing the pressed button number. This parameter is passed to the "LuminaireSetting" command "ActivatePreset". So the shown rule will activate a preset depending on which button has been pressed

The EnLight architecture scales smoothly from a single luminaire to many hundreds. This makes the luminaire best place to host the intelligence (decision logic) of a lighting system as the amount of intelligence in the system grows linearly with the amount of luminaires.

Using a standardized intra luminaire bus enables luminaire diversity based on a limited amount of standardized modules from different vendors. The consortium realized 14 types of luminaires, all based on the same building blocks. For these luminaires, a simple yet powerful decision engine (+ZigBee stack) was implemented on a low cost microprocessor (16 MHz RISC, 32 kB Ram, 256 kB flash). Further, the ILB framework showed that software reuse is possible when moving from modular hardware to fully integrated hardware (cost down for high volume).

Informing as opposed to controlling a luminaire implies that sensors and controls don't require any knowledge of the system's luminaires. Embedded sensors in combination with local intelligence allow simple and robust granular control, but a well thought-out communication framework is needed for the effective development of such a system. In this case, the use of a publish/subscribe design pattern results in very efficient communication and combined with the use of prioritized control (levels) delivers a very powerful solution for lighting systems with multiple sensors and controls. ■

New Form Factor Luminaires and New Light Effects

If luminaires designed for traditional light sources are simply retrofitted with LED light sources like it occurs in the so-called “1st wave of LEDification”, they will always fall short of expectations in many points. Herbert Weiß and Thomas Noll from Osram GmbH, Martin Möck from the University of Erlangen-Nuremberg, Martin Creusen from Philips Lighting, and Friedhelm Holtz from Insta Elektro GmbH explain why these shortcomings were addressed and which solutions were developed in the EnLight project.

One thing that all shortcomings of the “1st wave of LEDification” have in common is that a sustainable solution implies resolving fundamental contradictions which are based on the fact that the retrofit lamp does not fit the luminaire since it was originally designed for another technology like incandescent, halogen or fluorescent lamps, but not for LED lamps.

Examples for the Shortcomings of Retrofit Solutions

Screw base as disabler for minimizing junction temperature

It is quite obvious that incandescent lamp designs like those with an Edison screw base cannot fulfill one of the elementary LED lamp design criteria, namely to minimize the LED junction temperature. One key design aspect of the Edison socket has been to keep the heat in the system. The heat transfer path actually ends at the Edison lamp base. In contrast, for LED lamps and luminaires optimization of the heat transfer from the LED to the environment is essential for high efficacy and lifetime.

Luminaire optics are not suitable for light shaping of retrofit

If we consider, for example, a troffer luminaire using linear fluorescent lamps, it is an important design aspect for luminaire manufacturers to optimize the light output ratio by use of highly reflective materials for the reflectors and also by use of specially shaped reflectors. A classical example is an evolver design, which allows for guiding the reflected light around the lamp and

minimizing absorption of the reflected light by the light source itself. With these technologies it is possible to realize light output ratios of up to 90%. The problem arises when a linear LED retrofit lamp is used as a 1:1 replacement. The LED light source whose light distribution is now far from rotationally symmetric no longer fits the luminaire design. As a consequence the reflector might have no effect at all. Light distribution that is not desired by the user occurs or the luminaire glare rating is out of specification.

Wall switch/dimmer not in line with customer expectations

Retrofitting a luminaire also means that classical user interfaces - like the common wall switch or dimmer used to switch or dim the lamp - are generally maintained.

On the other hand LEDification and digitalization of luminaires open up far more possibilities for interaction. Automatic adjustment triggered by sensors or remote adjustment of light and light scenes by various user interfaces like a customized app via a smart phone are examples. Retrofits will never meet customer expectations arising from these possibilities for control.

Office Luminaires

For office applications, the focus is traditionally on high luminous efficacy, short return of investment and long maintenance factors. In this project emphasis was put on high light quality, i.e. high color rendering, pleasant appearance, the possibility for color and color temperature adjustment and exact control of the light distribution. All luminaires were built as intelligent luminaires, letting each individual luminaire make lighting decisions based on presence, occupancy events or ambient light information detected by its own integrated sensors, or events and information from other nodes in the network.

The following luminaire prototypes were designed accordingly.

Intelligent “PowerBalance”

The “PowerBalance” luminaire family from Philips consists of state-of-the-art energy-efficient office-norm compliant LED luminaires (Figure 1). These luminaires offer good-quality lighting solutions for direct replacement of T5 luminaires in most indoor office applications. The two form factors applied in the demonstrator installations, a standard troffer size with 2 x 8 reflector cups and a mini-“PowerBalance” with 2 x 2 cups, contained tunable-white EnLight compatible LED Light Engines (LLEs), and an embedded temperature, light and PIR multi-sensor from Valopaa. The outer dimensions were 1200 x 300 mm² and 300 x 300 mm², respectively. The 4-channel LLEs (warm white, cool white, blue and amber LEDs) using high power LEDs were driven by two 3-channel UBA3077 driver boards from NXP. The tunable white light output for the 2 x 8 cups “PowerBalance” (at 350 mA LED current) was >3000 lm for warm white and >4000 lm for cool white with an overall luminous efficacy of 105 lm/W. The Intra-Luminaire Bus (ILB) was used for internal communication between the different embedded components (i.e. LED driver, multi-sensor



Figure 1: “PowerBalance” luminaire with 2 x 8 reflector cups (left). Mini-“PowerBalance” luminaire with 2 x 2 reflector cups (right)

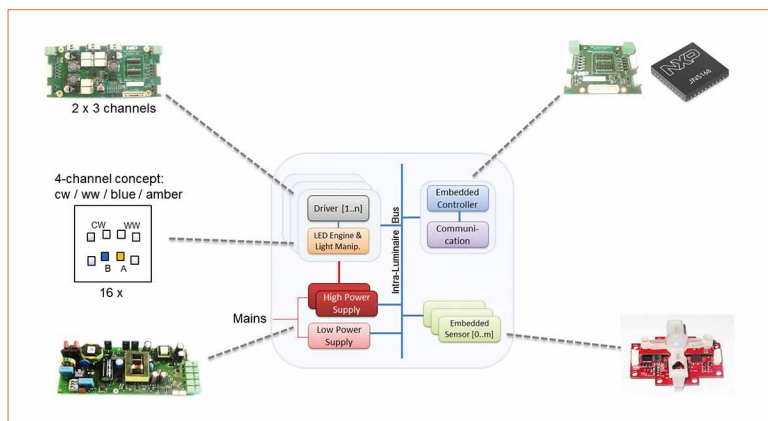

Figure 2: EnLight architecture of the “PowerBalance” luminaire



Figure 3: InstaLight Glow luminaire

and controller board). All mentioned components were connected in a daisy-chain configuration (Figure 2).

Intelligent “Glow”

In contrast to the flush mounted PowerBalance recessed luminaire, the intelligent instalight Glow luminaire contributed by Insta Elektro GmbH is a linear pendulum luminaire with direct / indirect LED light output. The light distribution of the direct outlet is controlled by lenses which resemble big drops of water protruding from the luminaire. This notable design makes the luminaire suited not only for the illumination of workplaces but especially for reception areas, lobbies and conference rooms.

The drop-shaped optics of 80 mm diameter is made of clear acrylic glass. Optics is optionally available in an internally satined version that gives the luminaire a less technical

and more smooth and classical appearance. Four LED and lens modules are arranged at each end of the 1500 mm long luminaire. This task light component is available in color temperatures 3000 K or 4000 K. It provides > 3100 lumens and a color rendering index of > 85. The overall luminous efficacy of the task light component is 87 lm/W.

Separately dimmable indirect illumination was provided by RGBW LED modules concealed on the back side of the luminaire. The user was free to choose from the entire RGBW color gamut range.

The luminaire complies with standard EN 12464-1 regarding omnidirectional glare reduction.

The luminaire had embedded sensors for motion, illuminance and color temperature control. The luminaire architecture followed

the same concept as depicted in figure 2 but with different numbers of LED and driver boards. The Glow luminaire had a one-channel LED board for direct and one four-channel LED board for the indirect light output.

Luminaires for Hospitality Applications

For a hospitality environment EnLight provided much more than just conventional luminaires. Prototypes demonstrated in this project proved that, by exploiting the design freedom enabled by LED, luminaires can be realized which provide more than just illumination for a visual task. They became not only the actual creative element but even merged into building structures and took over part of their functional properties.

“Luminous Door”

The luminaire with the highest functional versatility and functional integration into building components realized in this project was a luminous door (Figure 4) developed by OSRAM. Both back and front sides emitted light and could be controlled individually, including individual control of all four frame parts (top, bottom, left, right). Colors and color temperatures could be varied within a large gamut range, which is achievable with warm white, red, mint and blue LEDs. The door was virtually mimicking a window and is thus ideal for places like windowless

rooms deep inside a building. Due to its very large light emitting surface this luminous door allowed for the creation of a wide set of scenes like sunrise or favorite color patterns for mood lighting. The physiological impact can be used for light therapy such as alleviating jetlag or treating seasonal affective disorders. Glare was not an issue despite a very high maximum luminous flux up to 10,000 lm depending on color temperature or color settings. The maximum luminance was 4000 nits (cd/m²).

The door was equipped with embedded PIR sensors from Valopaa for interaction with a preconfigured light level and varying colors and patterns. One sensor was placed near to the door handle. Luminaires or other devices in the room were thus activated as soon as someone was using the door handle. In the same way sensors in the room checked for occupancy when the door handle was touched upon leaving the room.

Another option was to use the luminous door for showing a hotel guest the way to his room by raising light output, or tuning color.

The luminous door was made of linear multicolor LED boards, which were hosted inside the doorframe. Their light was guided into the edges of special PLEXIGLAS® sheets which homogeneously coupled the light out of the sheet's surface. Light exiting towards the inside of the door was redirected

to the outside by a white sheet with predominantly diffusive reflectivity of about 99%. Thermal management was highly efficient since LED boards as well as heat sensitive driver components were coupled to the metal door frame which had a large cooling surface.

“Wedge” luminaire

A luminaire developed by OSRAM which served as a platform for a wide range of room lighting and decorative designs was dubbed “Wedge” for its wedge shaped design. Light was emitted at the wide edge of the “Wedge” which is ideal for mounting the luminaire on vertical surfaces to light a desk (task lighting), on the ceiling or just for a wall-wash effect. With a maximum height of only 25 mm the luminaire was exceptionally flat and required little mounting space. The unobtrusive appearance made the luminaire almost disappear, and directed the user's attention to the light and the illuminated object.

Similar to the luminous door, multicolor LED modules consisted of warm white, red, mint and blue LEDs for full color tunability. LEDs were placed in a highly reflective mixing chamber which was optimized for high light output, homogeneous color mixing and prevention of direct glare from direct view into the LED light source. Since the housing was made of metal, it was effectively used for heat spreading and cooling of LEDs and electronic components. In order

Figure 4: Luminous door with two light emitting sides. Examples of homogeneous daylight as well as of a colored pattern is shown

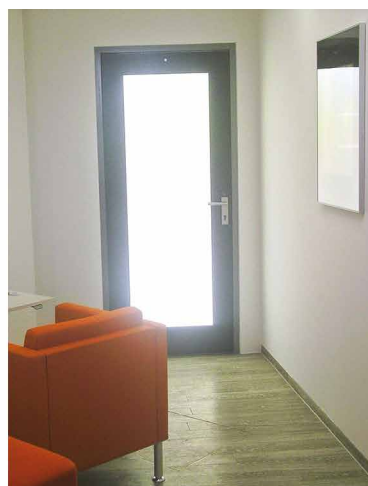

to enable emission and reception of radio signals within the wireless EnLight communication network a plastic window was inserted into the metal housing just above the radio antenna.

“Wedge Wall”

The side emitting design of the “Wedge” luminaire was especially suitable for light arrays, where multiple panel configurations allowed design freedom. Together with the variability of color temperature and color combinations an infinite number of scene settings can be achieved. A selection of different settings, which were chosen for the installations, is shown in figures 6 and 7.

Similar to the luminous door, the “Wedge Wall” allowed glare free illumination and mood lighting. Indirect lighting was dynamically tuned and adjusted. The wedge wall and the luminous door substantially contributed to vertical lighting. Horizontal lighting is a mainly functional property requested by standards with regard to the execution of a visual task on horizontal surfaces. Vertical lighting is more and more recognized as a vital prerequisite for spatial experience. The wedge and door luminaires not only enabled the architectural construction of spaces with light but also provided a pleasant experience where people came to meet and talk. With a high component of vertical lighting, faces were well illuminated and not obscured by shadows.

“Wedge Wall” architecture

The “Wedge Wall” provides a good example of how the modular architecture can be employed for most flexible configuration of

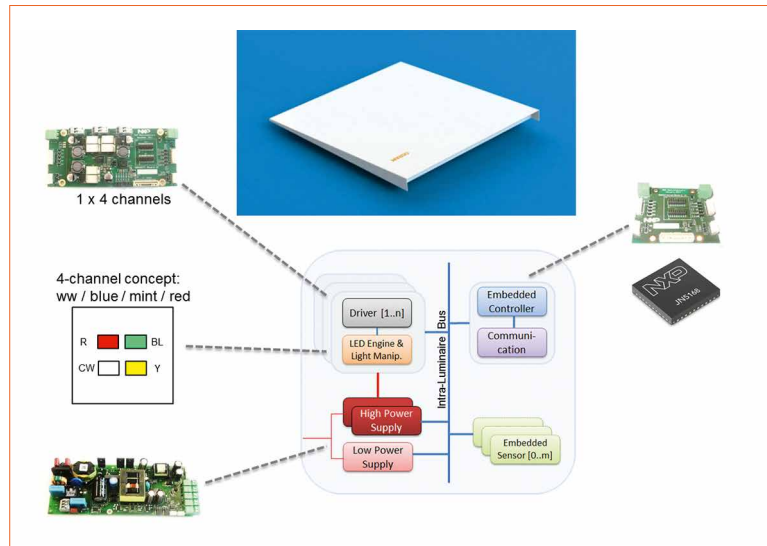

Figure 5: “Wedge” luminaire and luminaire architecture

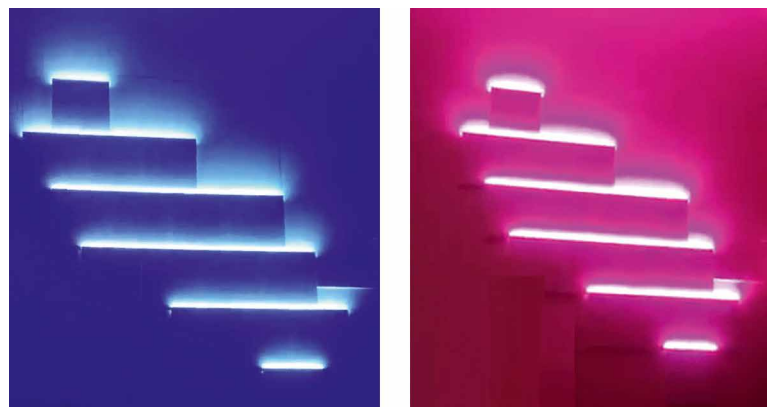

Figure 6: “Wedge Wall” scene settings at the office demo at VTT, Finland

multiple components and luminaires (Figure 8). The entire “Wedge” panel was regarded as a single luminaire which is composed of modular building blocks. For the hospitality demo shown in figure 7 a total of 12 “Wedges” were used in one panel. Three 75 W power supply units supplied the entire panel. Wireless communication from outside the panel was done by ZigBee to the luminaire controller. If the intra luminaire communication bus, developed in the course of the project, was used for communication from the luminaire controller to the LED driver controllers, luminaires, sensors and user interfaces could be readily added or removed without further need of re-commissioning.

The “Wedge” luminaire panel was installed in different configurations with 8 “Wedge” luminaires at the office demo at Philips, Netherlands and with 16 “Wedge” luminaires at VTT, Finland (Figure 6). In these cases branches of 4 “Wedge” luminaires were simply removed from and added to the configuration in figure 7, respectively.

The “Wedge” wall concept demonstrates how an apparently complex intelligent luminaire can be configured by just “stock-picking” ingredients” from the building block inventory (Figure 1 in the “EnLight Intro-Overview”) without a special need for customized development.



Figure 7: “Wedge Wall” scene settings at the hospitality demo at Osram GmbH, Germany

Figure 8: Architecture of the “Wedge Wall”- a panel with 12 “Wedge” luminaires is shown in this example

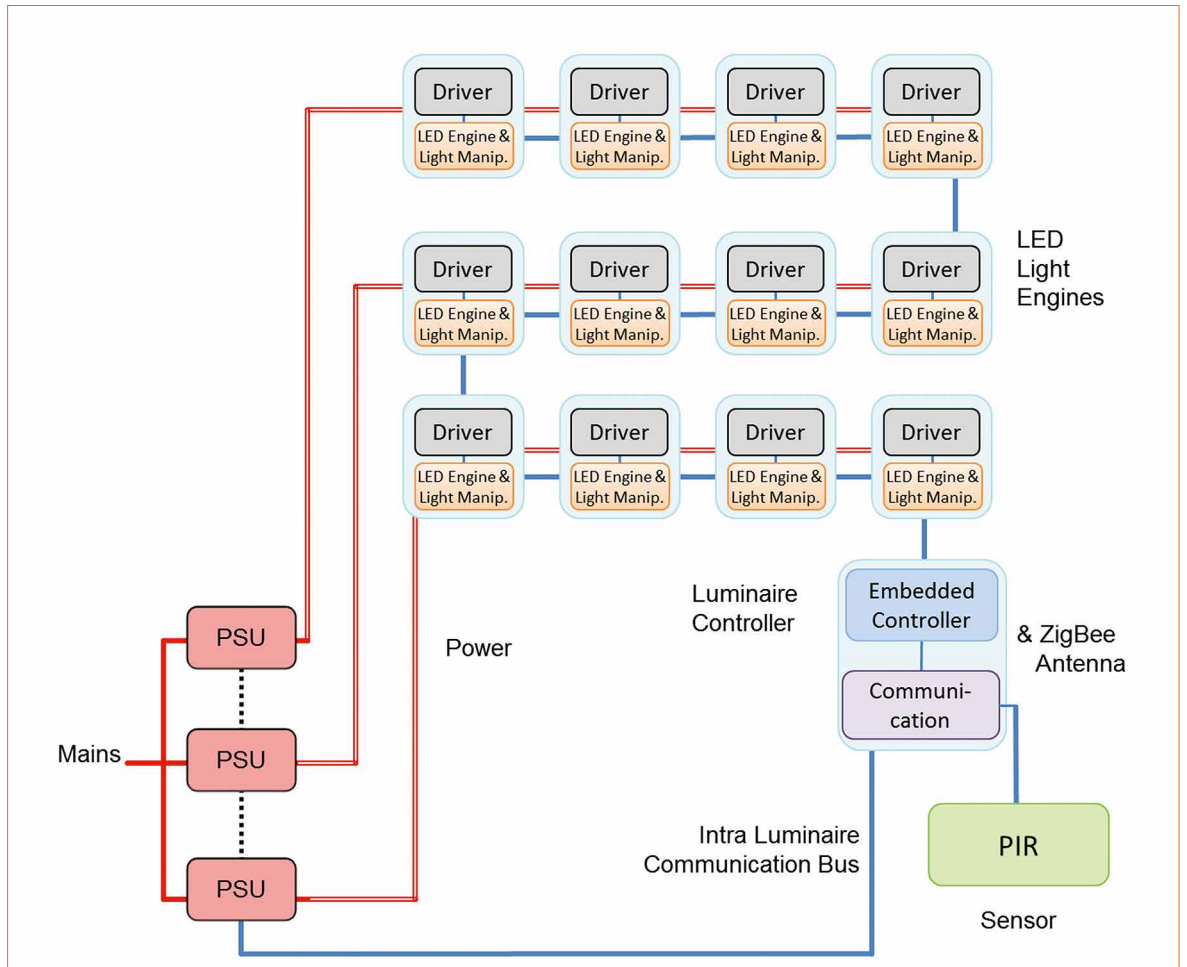

Luminaire for Accent Lighting

Spotlight luminaire

A spotlight luminaire suitable for track light mounting was developed for the purpose of adding accent lighting to EnLight installations. This luminaire demonstrated that with the use of LED technology

luminaires can be given thrilling designs to which we had not been used to in traditional lighting systems. Spotlight luminaires designed for the use with legacy light sources are usually associated with elongated cylinders and long parabolic reflector shapes. For the luminaire an extremely small LED light kernel with a diameter of only

6 mm was used. The étendue which governs the size of the entire optical system was thus very small. In combination with a Fresnel TIR lens, which was optimized for maximum flatness the whole luminaire aspect ratio represented the extreme opposite of conventional designs. Lighting module and track light

Figure 9: The light distribution of a spotlight on a projection surface (left) and the measured light distribution graph (right)

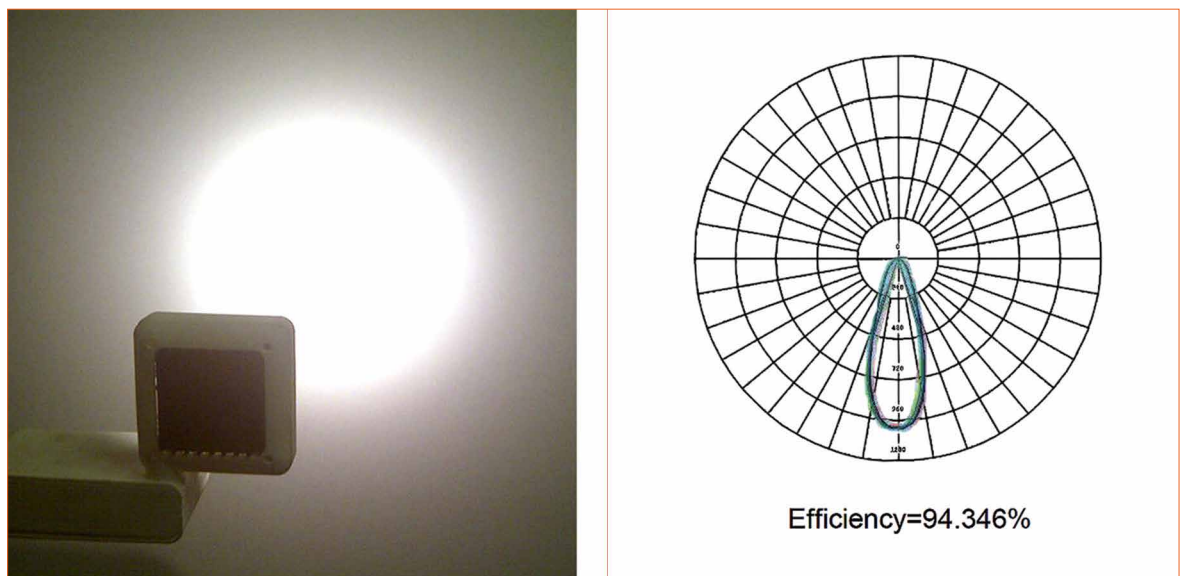



Figure 10:
EnLight spotlight
luminaire

body were both cubically shaped which gave a consistent style and harmonic overall appearance.

Efficacy was not sacrificed by this design. The flat design rather improved thermal management. The light kernel was mounted directly on a heat sink at the back of the luminaire and an open structure allowed for air flow through the lighting module and enforced convective cooling.

The high lens optical efficiency led to a light output ratio of close to 95% for the used light kernel. The total luminous output was 500 lumens with an overall luminous efficacy of 80 lm/W.

The light kernel provided a red, blue and mint color combination. Light mixing was done by a diffuser cast on the light kernel level. In combination with the lens optics a perfectly homogeneous light distribution of beam angle FWHM = 30° was achieved (Figure 9 - right).

As with all other EnLight luminaires, color and color temperature tuning was implemented. Electronics driver and control components were placed in the track light body.

Conclusions

The project partners developed various luminaires that followed the same modular building block concept of the EnLight component inventory. These luminaires were integrated into the office and hospitality installations. All luminaires demonstrated that this new luminaire system architecture with a high degree of modularity and extensibility, enabled by the intra-luminaire communication bus, is working. The new level of freedom in configuration and combination was used to realize concepts which would have been much more complex and less configurable in the past.

In contrast to the retrofit approach, EnLight luminaires widely exploited design possibilities dedicated to

LED technology. LED light source efficacy was optimized by thermal management concepts, which minimize the LED junction temperature by making use of functional and design structures of the luminaire without adding bulky cooling bodies. High light output ratios added to the overall luminaire efficacy by means of optical designs which fully take into account the light source properties and the desired luminaire light distribution.

New form factor luminaires were demonstrated that break completely free from conventional designs and take the notion of a luminaire to a level that would have hardly been considered with traditional light sources. ■

The Building Blocks for Intelligent Future Luminaires

The EnLight consortium came to the conclusion that to provide cost effective solid-state lighting products there are several aspects in which a modular approach seems to be advantageous. Tim Böttcher and Lucie Chandernagor from NXP, Philippe Maugars from PMC, Hannu Vihinen from Helvar, Mark Coopmans from Philips Lighting, Olli-Pekka Jokitalo from PKC Electronics, Raimo Ontero from Valopaa, Christian Paul from Infineon, and Rafael Jordan from Fraunhofer IZM explain how the new approach works.

Figure 1: Set of four different luminaire types build on the same set of hardware

The EnLight Lighting System design was based on a modular hardware approach, which was founded on a Plug-and-Play hardware bus and distributed intelligence of the individual communicating luminaires. This modular approach allowed realizing the required large variety of luminaires with a

limited set of hardware, even coming from different partners. The functionality of the individual luminaire was then only realized in software and no hardware change was required. An example of the variety of building blocks inside one luminaire is illustrated in figure 1.

In order to give as much freedom to the luminaire design as possible, it was intended to have very compact and energy efficient modules. Besides the small size, this allowed the heat sinks to be reduced in size or to use parts of the luminaire housing as heat sink.

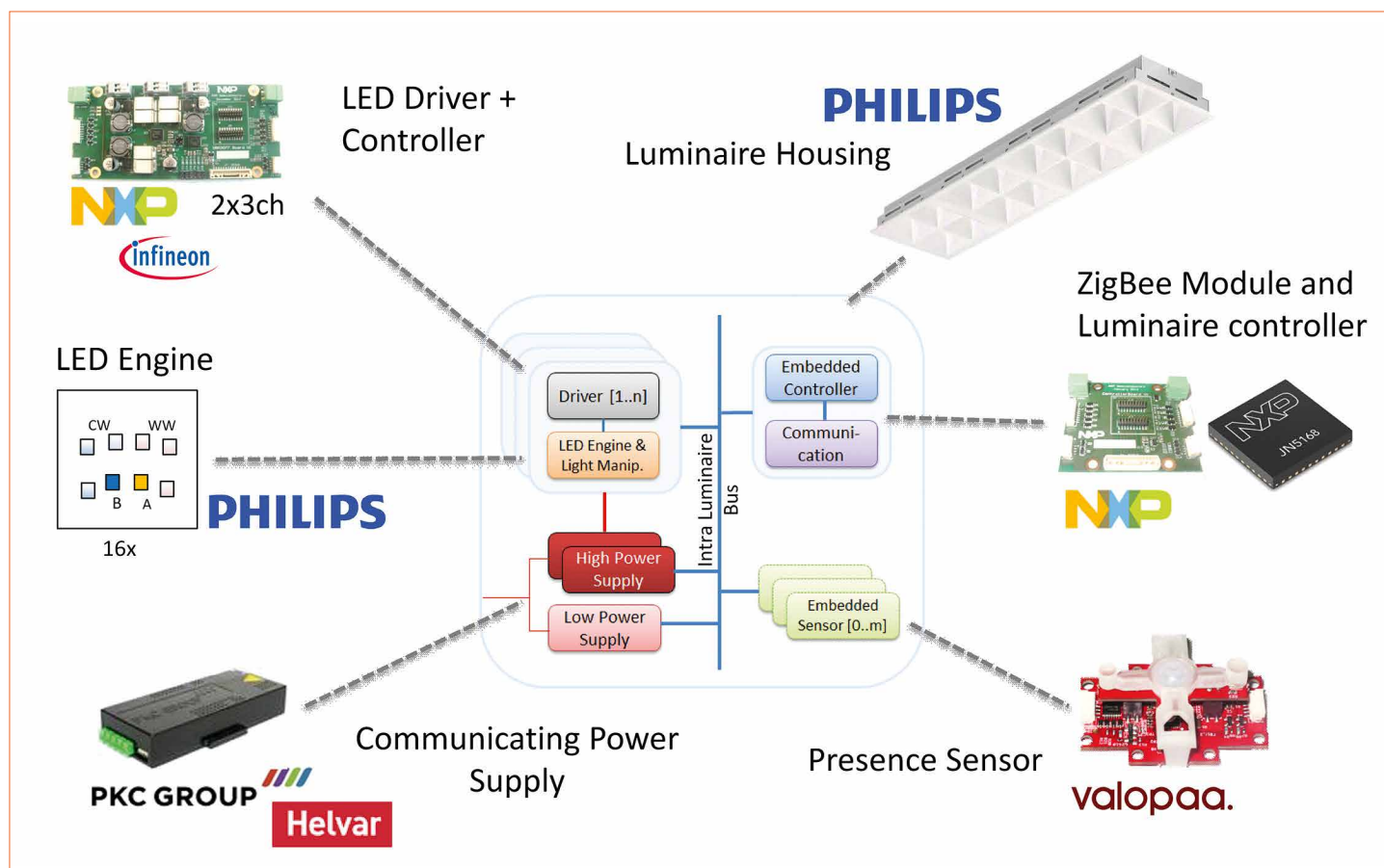

Diversity Management

In order to connect all the individual modules, a novel bus system was developed. Since several partners contributed to the hardware platform, the bus system was required to be highly flexible and simple to adapt to the actual hardware requirements. In the following section the hardware and the software parts are illustrated.

ILB hardware bus system

The EnLight luminaires were based on LED driver and communication modules, which were connected through a standard I²C bus. The bus driver was modified in such a way, that the plug-and-play operation of modules is possible. Within one luminaire, one distinguishes the Intra Luminaire Bus (ILB) and the LED driver bus. The ILB bus system is connecting the individual modules on hardware basis to an intelligent luminaire controller. The LED driver bus purely operated in master-slave mode in order to distribute commands to the PWM generator on the LED driver board. All modules and boards were designed to allow the daisy chain connection of boards, thereby simplifying the wiring in total. An example of such a luminaire configuration is shown in figure 2.

The decision engine was placed in the intelligent controller module, which was commonly connected to the ZigBee or area network. Based on the programmed rule set in use, the controller translated the rules into module commands on the ILB network. The behavior of the luminaire as a whole was then only defined by the rule set programmed into the intelligent controller. Accordingly, it was possible to use standardized and small LED driver modules to operate the LED strings, which were connected on the ILB bus in order to build luminaires of all sizes.

ILB software bus system

The main concepts behind the Intra Luminaire Bus (ILB) are to introduce modularity, yet allow an easy

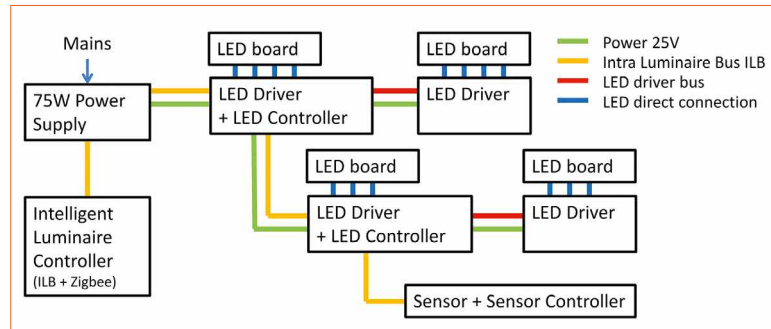

Figure 2: Bus system inside an intelligent EnLight luminaire, connecting LED driver and sensor boards

integration if required for BOM. As illustrated in figure 3, the ILB framework forms a platform for functions that need to communicate to one another, where a function (e.g. presence sensing) typically consists of a hardware part and a software part. In ILB the software part is referred to as an application.

Technical features of ILB are:

- Reusable and exchangeable building blocks
- Abstraction from implementation technology (e.g. PIR vs. Ultrasound for motion detection)
- Application software integration into combined hardware execution platform
- Multi-master mode enabling low standby power
- Plug and Play
- Portability to different physical communication layers (e.g. I²C, RS485)

When partitioning the system in hardware modules, a function may migrate from one hardware module to another, depending on the most appropriate implementation for that system. To support such a migration, the ILB framework abstracts the physical location and routes messages between modules as applicable.

The ILB framework is a shared software component that:

- Provides address resolution and physical communication between hardware modules
- Provides an interface for applications to exchange messages
- Associates an application with the appropriate hardware module
- Provides a managed message set

One of the applications is a controller implementing the intelligence in the form of a decision engine, which takes input from sensor applications and drives lamp applications.

During power up, an address requesting service queries the address assignment service for a unique I²C hardware address to be assigned. Similarly for the module ID service after a hardware module was assigned a hardware address. The controller is the only module that is found on a fixed hardware address. All other modules are assigned a hardware address (and also module ID) dynamically.

Hardware Modules

The implementation of the actual hardware was guided by the luminaire requirements, which, in particular constrained the possible volume and the heat management of the modules. Here, the key modules are described by example.

Power supply units

The Power Supply Units (PSUs) were AC/DC converters designed for this new architecture. Each PSU contained two separate power supplies: high power supply (HPS) for LED drivers and low power supply (LPS) for ILB devices. To address all luminaire needs, two different PSU versions with a power of 75 W and 20 W were developed. The main criteria for the PSUs were high power factor, high power conversion efficiency and low stand-by power. The power factor corrector was based on a boost topology with quasi-resonant control, which results in a power factor of up to 0.97.

Figures 3:
The ILB framework
as platform for
communicating
applications

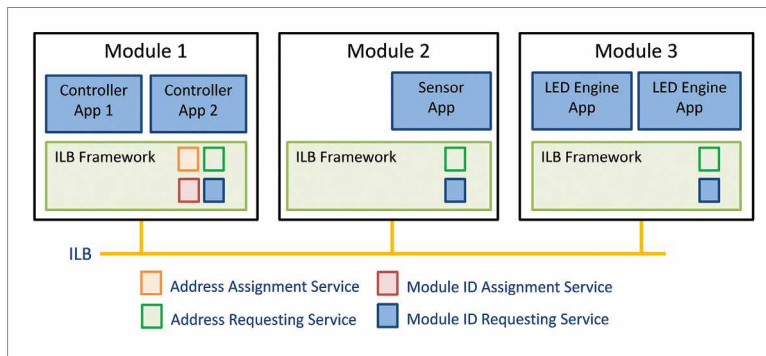

Figure 4:
The block diagram of the
power supplies

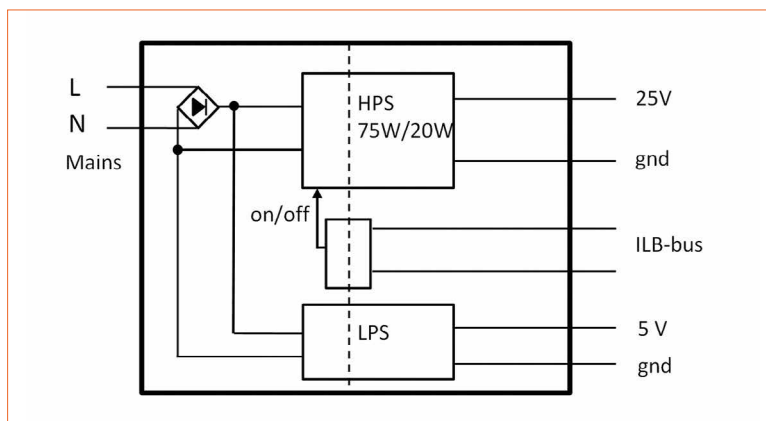
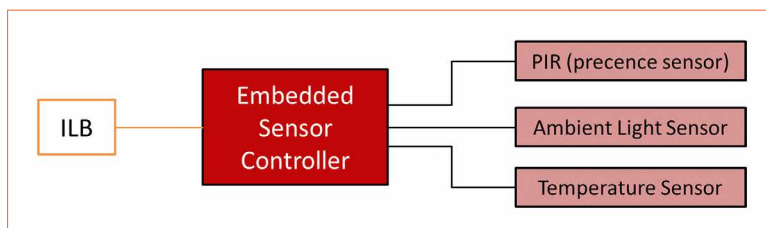

Figure 5:
Embedded sensor
block diagram



The 75 W HPS used a LLC resonant topology with synchronous secondary side rectification (NXP SSL4120T). The 20 W HPS was driven by a quasi-resonant flyback controller (NXP TEA1755T) with synchronous secondary side rectification. The LPSs of both PSUs were based on a flyback converter that enters the burst mode at low load to ensure low losses. The functional block diagram of the units is presented in figure 4.

Also, up to 4 pieces of the PSUs can be combined to form high power luminaires. When the LED load was switched off completely, the main power supply was switched off as well via the ILB-bus.

Embedded ambient sensor

Embedded sensor boards were designed to provide luminaire level information on movement of

people, prevailing ambient light level and temperature inside the sensor. The sensor boards accommodated sensor controller, PIR sensor, and ambient light sensor and temperature sensor. They were powered from 5 V DC supply, delivered via ILB bus connector and from which power consumption below 10 mW is achievable. The functional block diagram is presented in figure 5. The sensor boards were designed in two form factors to fit into different luminaires.

LED driver boards

The LED driver boards were designed to operate autonomously once a defined setting is programmed through the ILB. This was achieved through a pulse width modulation (PWM) expander (NXP PCA9685), which had an I²C interface to the LED driver

controller. As illustrated in figure 6, the setting from the intelligent luminaire controller was translated by the LED driver controller into a set of required PWM signals. The related commands are then given to the PWM expander, which independently generates the PWM signals for the DCDC converter at the LED strings.

One DCDC LED driver for short strings was designed for an average LED current up to 0.7 A (Infineon ILD6070). Switching and conduction losses of the IC were minimized to achieve a high efficiency. LED driver switching frequencies up to 1 MHz enable the use of low inductance inductors keeping the board size small while achieving high slew rates of the LED current. The high slew rate together with the short PWM delay time of the IC allowed high contrast ratios in each LED string. For long LED strings, boost DCDC LED driver boards were designed accordingly.

Intelligent controller and ZigBee communication

A combined CPU and ZigBee transceiver for all EnLight building blocks was chosen (NXP JN5168). On most of the modules, a connection slot was reserved so to be able to plug a standard CPU / ZigBee module flashed with the relevant firmware when necessary. Although the communication function was not needed in all modules, the same controller chip was chosen so as to have full flexibility for reuse of the embedded SW blocks without any redesign.

The dynamic smart lighting requirements from EnLight require a major extension of the hardware and software capabilities. A new ZigBee stack was developed, enabling up to 250 nodes in a single network. The radio receiver, optimized for better efficiency allowed lowering the standby consumption below 100 mW, thus meeting the future targets. The chip will feature a full Multi Master I²C bus that improved the performances of the ILB bus

described above. A full function JTAG debugger allowed easier and faster real time software development, and a larger flash memory will enable seamless over the air re-flashing. The block diagram of the new chip is displayed in figure 7.

Miniaturization

To go beyond the given size constraints from the chosen EnLight luminaires form factor, the miniaturization of modules was evaluated further. Here, different aspects such as board design and LED design were addressed.

Compact single stage PSU for simple luminaires

Most EnLight luminaires featured several LED strings, or even several LED Light Engines; therefore, the two-stage topology with central PSU previously described, was chosen. However, for some simple luminaires a single stage approach is more appropriate, since this allowed a more compact electronic module and lower standby power consumption.

Such an application was developed, tested and demonstrated (NXP SSL5511). Figure 8 shows the mains interface, the manual switch, the Jennic module with printed antenna and the connections to the LED module. The compact size (10 x 7 x 2 cm) allowed the

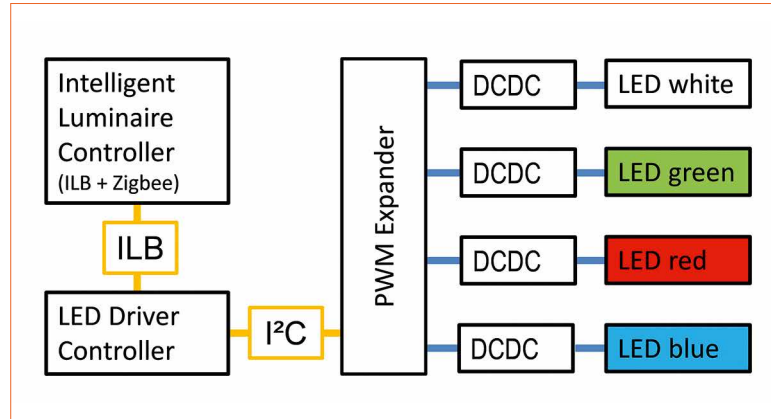

Figure 6: Hardware bus system inside one LED driver board connected to the ILB

integration of the module in the foot of the lamp, which was not possible with the two-stage design.

technologies and the thermal pad was insulated from the electrical connections, illustrated in figure 9.

Integrated LED light engine with hermetic package

Another component for the modular luminaire was a spotlight with about 1000 lm out of a 20 mm² package surface. As the project partners always focused on forward looking solutions, this module had to be hermetically sealed to withstand humidity as well as harmful gases and other harsh environments. To achieve this goal, a completely new approach was launched, starting from thermal and thermo-mechanical simulations, developing a complete 8" wafer level packaging process and assembly of prototypes. The packages were designed for flexible configurations with pure white LEDs, RGB-LEDs or even additional sensors. The footprint is compatible with standard board

The assembly process of the packages was chosen in a way that no step would re-melt prior interconnections and that the final package would withstand process temperatures up to 270°C. Known and new technologies like eutectic bonding, anodic bonding, transient liquid phase bonding and more were chosen the way that no polymeric or other permeable interfaces are built. Therefore, the package is completely hermetic and highly reliable.

Energy Efficiency

The project achieved the energy efficiency targets, in particular, through intelligent control of the illumination on the basis of highly efficient modules in the system electronics. Examples of this work are illustrated in the following,

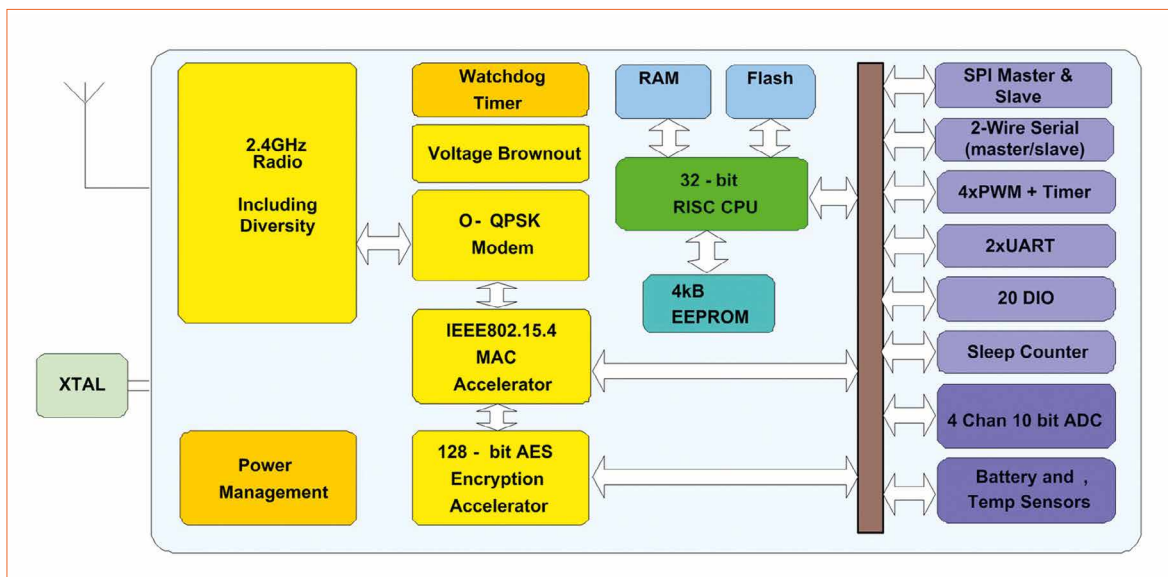

Figure 7: Block diagram of the JN5169, a CPU / ZigBee chip based on the project findings

Figures 8 & 9:
Compact Supply/
Driver/Communication
module (left).
A hermetic package
housing red, green
and blue LEDs. The
background shows
the wafer on which
the LED light engine
was manufactured (right)

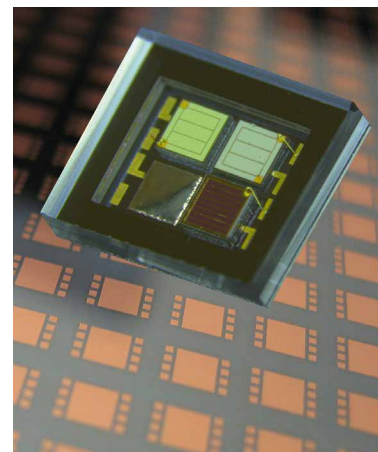
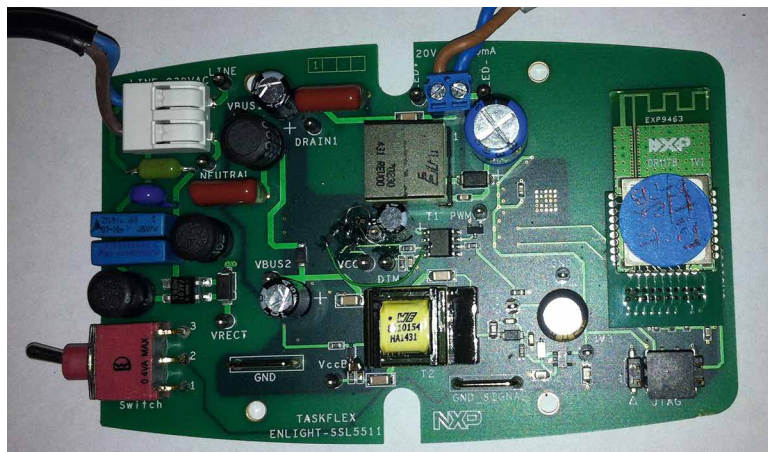
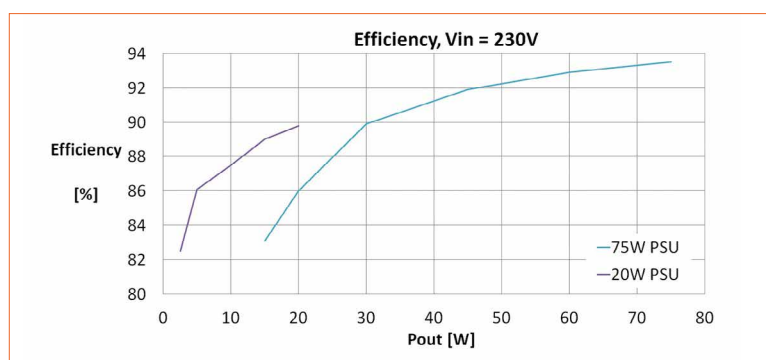

Figure 10:
The efficiencies of the
PSUs as a function of
the output power



where components designed for the specific requirements of intelligent lighting are described.

PSU and LED driver efficiency

The efficiencies of the PSUs at full load were about 93.5% (75 W PSU) and 90% (20 W PSU). However, even more important is the good efficiency throughout the entire load range in a system where the energy consumption is minimized by dimming or shutting down the LEDs. In figure 10 the efficiencies are plotted as a function of the output power, showing the efficiency above 82% even at the lowest load.

The 75 W PSU was able to receive commands on the ILB bus, such that the high power output can be switched on/off in order to optimize load and losses. The standby power loss was then down to 160 mW. However, the standby losses depended on the quantity of devices connected to the ILB-bus. The low power output is always on and it provided the power to the control circuitry of the system.

The complete LED driver in an EnLight luminaire with 25 V DC supply voltage (including losses of inductor, current sense resistor and Schottky diode) achieved efficiencies above 95% driving 6 LEDs at the rated current of the IC. In PWM dimming down to 1% duty cycle the efficiency of the LED driver was better than 81% due to the low power consumption of the IC, which is a prerequisite for intelligent lighting with its intense usage of dimming and color control.

Wake up radio

Even if the ILB cuts off the main power supply, the receiver still drains power on the order of 100 mW. The wake-up radio is an additional receiver only in charge of the activation of the application (Figure 11). As a net result, the standby power use of the whole application was reduced to the power consumption of the wake-up radio. This consumed only 100 μ W, i.e. a thousandth of the standby power consumption. Setting a lower operation rate at the cost of a higher latency time can reduce this consumption further.

The wake-up radio was designed in CMOS technology and operates on its own supply source at 3.3 V. In standby mode there is no power drain on the main supply.

When a user presses the command switch, an activation message at 433.92 MHz is emitted. This wake-up message is Manchester encoded at 25 kbit/s. The 24 bits address it contains is programmable by SPI bus. If the expected code is received, the wake-up radio provides a pulse that drives an electrical relay connecting the main supply to the application. This pulse is delivered with a maximum latency time of 125 ms. The wake-up radio achieves a - 55 dBm sensitivity that allows for a 10 m range in indoor conditions when using a standards regulation compliant 10 dBm emitter.

The wake-up receiver is compatible with a ZigBee transceiver. Indeed, it is therefore suitable for use at 868 MHz or 2.45 GHz. ZigBee transceivers are able to generate the wake-up message subject to software modifications.

DCDC choice of the flyback diode in the LED driver

In the chosen low cost non-synchronous LED driver architectures, Schottky diodes were used due to their low forward voltage during conduction and the fast switching. However, choosing an optimal diode for the application was not straightforward due to the loss contributions arising from forward conductance,

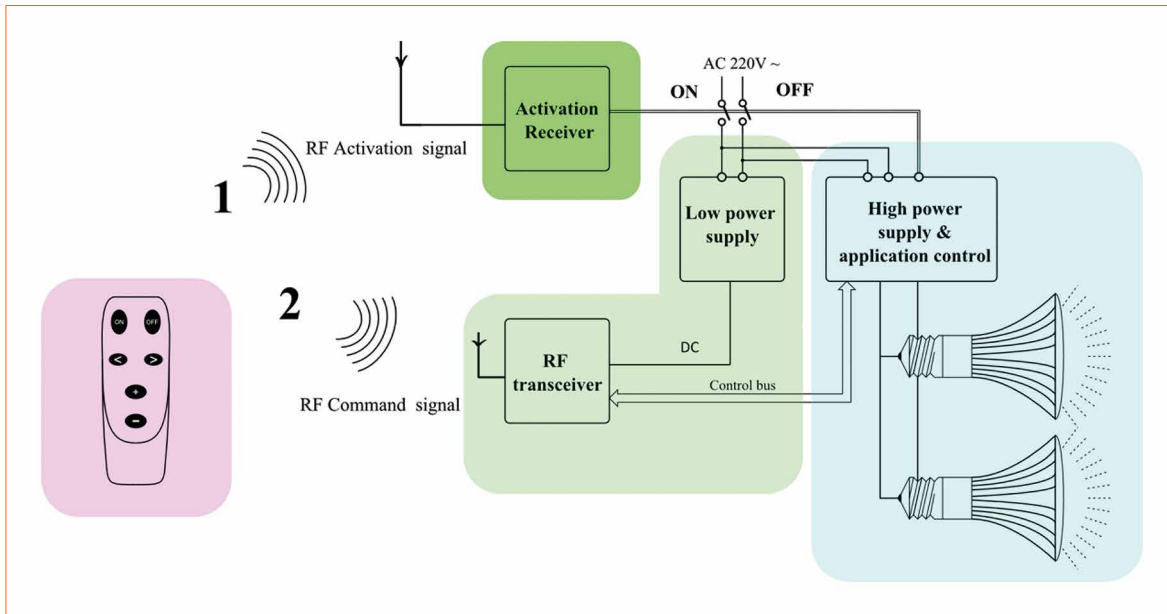

Figure 11:
Schematic diagram
of the wake up radio
application

leakage current and switching. The peak efficiency of the buck DC-DC converter exceeded 95%, and by choosing the correct Schottky diode the efficiency can be increased to 96%. At low load conditions, the efficiency improvement can even be as high as 5%. This does not seem impressive, but it translates to a reduction of the losses by more than 20%, easing the requirements on the thermal design.

One might think that a Schottky diode with lower forward voltage drop V_F would always result in better efficiency. This is based on the assumption that the losses due to the leakage current and the switching are negligible. It is valid as long as the conversion frequency is not too high. Once the board operates in the range above 100 kHz as for the EnLight design, the switching losses become relevant for the system. Figure 12 shows details of the loss contributions for an LED driver with 6 LEDs, operating at 300 kHz. Except for the ultra-low V_F PMEG3050BEP that has a very high leakage current, loss due to reverse leakage is negligible as compared to the switching loss and the forward conduction loss. Interestingly, the smallest diode with the highest forward voltage PMEG4020EP gives the highest efficiency due to the smaller switching loss.

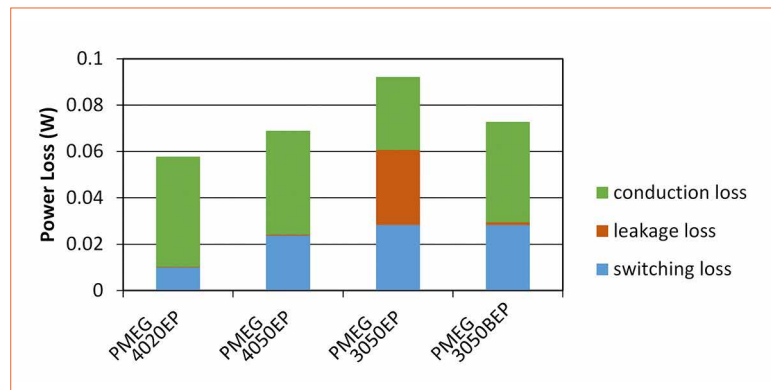

Figure 12:
Power loss
contributions in the
flyback diode of the
DCDC LED driver

Since the I-V and C-V characteristics of Schottky diodes could be well described by SPICE models, it was possible to evaluate the total loss of the Schottky diode in this application in the design phase and even to predict the operating temperature.

Conclusion

This Chapter detailed the design of the modules inside the intelligent and energy efficient EnLight architecture. It was shown that it is possible to build a large variety of luminaires on the basis of few hardware modules from different suppliers, which are seamlessly integrated via the smart usage of reusable software on top of I²C bus architecture. This Intra Luminaire Bus is fully plug-and-play from a hardware and software perspective, enabling the easy and secure replacement of modules inside one luminaire. The application of

intelligent lighting with its intense usage of deep dimming and color control is supported by the power electronics, which were designed to deliver high efficiency at full and partial load. Embedded sensors and the distributed presence of controller modules enable the intelligent control.

To conclude, the modular architecture supports future lighting system upgrades facilitating the shift of the current linear economy to a more sustainable circular economy. Easy exchangeable (modular) lighting systems, as opposed to “sealed-for-life” systems, are required to realize this circular economy. ■

Peripheral Devices for the Right Light

The EnLight project looked for greatly improved energy efficiency and user comfort in lighting applications. Werner Weber from Infineon Technologies, Lex James from Philips Research, Arjan van Velzen from Plugwise, Bruno Vulcano from Legrand, Micha Stalpers from AME, Arend van de Stadt from Eagle Vision Systems, Jens Döge from Fraunhofer IIS/EAS, and Wilfried Rabaud from CEA Leti explain how a closer relation between the user and provided light made it happen.

Figure 1: Building blocks developed for sensors and local user controls during the project

The closer the relation between the user and his requirements in terms of light provided in space and time, the better the comfort. These demands were fulfilled by advanced sensors and EnLight's distributed rules-based intelligence concept. Various physical parameters are important and need to be measured to allow proper decision-making such as occupancy, position of people in a room, level of outside lighting and temperature. The sensors developed and implemented into the lighting control network as well as the user controls are summarized in figure 1. Those peripheral devices are connected to the Lighting Control Network schematically shown in the illustration.

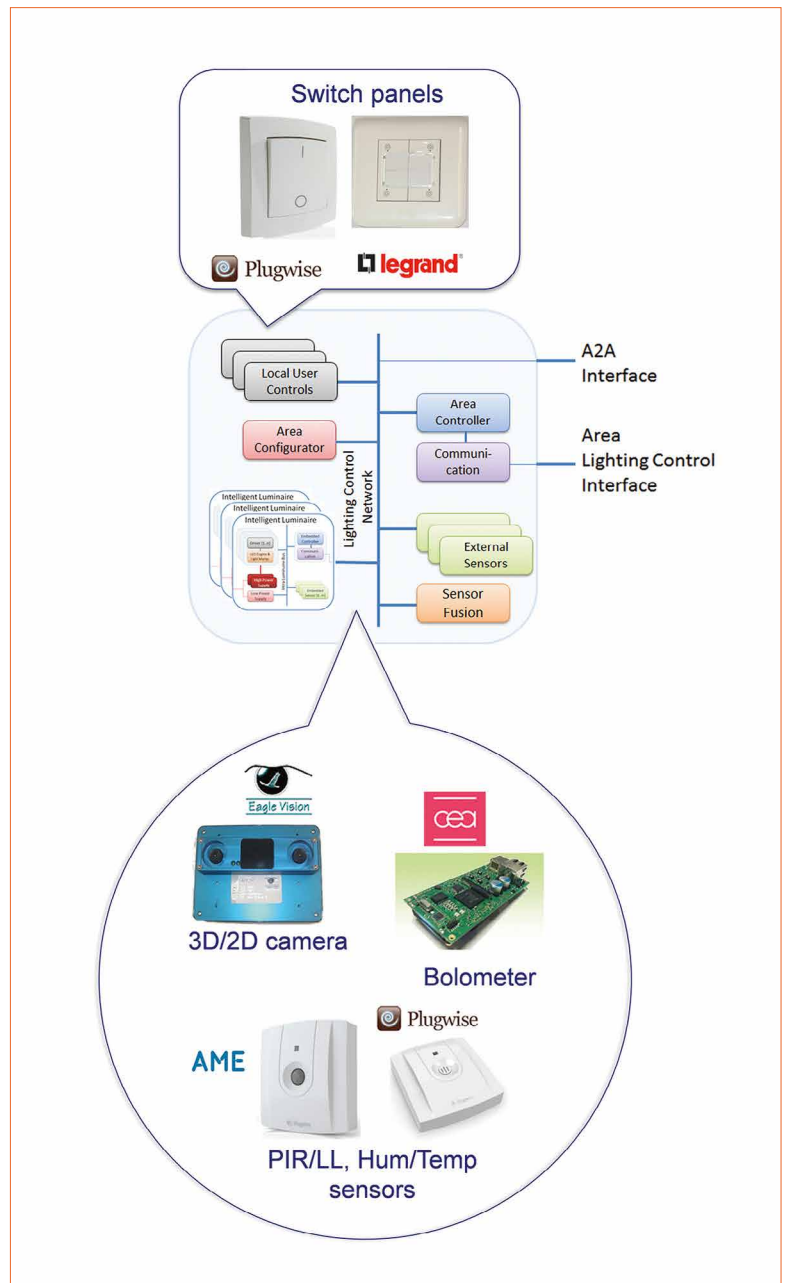

Sensors and User Interfaces

Before the different sensors are discussed one-by-one, the role of sensors and controls in this project is highlighted. The context was presented in general terms in the EnLight architecture paper in this article series [1]. Here, a few examples shall clarify the concept.

The sensors discussed in this paper provide information but they do not make decisions. Decisions are only made in the luminaire. In this architecture on the one hand, the sensor is acting independently of the way its output is used and on the other hand the control in the luminaire is rather flexible in the use of different sensor data depending on the application. Flexibility is largely enhanced by this architecture which uses a standardized process in the publication of data (e.g. by the sensor) and subscription to the receipt of data (e.g. by the luminaire).

In order to exemplify the context the user can press a button on a panel with two buttons. The button has no knowledge of what it means when it is pressed. The user knows what the pressing of a button means and the luminaire acts on rules to interpret the information.

The pressing of button ONE can mean

- Luminaire 1 to dim-up
- Luminaire 2 to increase the color temperature
- HVAC to increase the temperature

and the pressing of button TWO can mean

- Luminaire 1 to dim-down
- Luminaire 2 to decrease the color temperature, and
- HVAC to decrease temperature

In any case, the button itself only provides the information that a certain button is pressed. The luminaire can interpret this information by a rule-based action.

This example illustrates the decoupling of domains (sensors and luminaires in this case). The decoupling allows

the system to react on a sensor signal from a domain that is not lighting related, e.g. smoke alarm provided by a CO₂ sensor:

In this context so-called “virtual sensors” are possible. For example, a luminaire with a decision engine can generate an event stating the presence of persons, rule-based on the information from various presence sensors in a certain area.

Another example of a virtual event is a peak load-limiting signal coming from the smart grid to request temporary power reduction. Luminaires can be provided with rules that react to such an event so the lighting system can respond to the request.

In the following chapters a user interface tool for commissioning application in EnLight systems, a specific local user control, and different presence sensors/cameras are discussed based on different technical concepts and considering the privacy aspects.

User Interface Tool

Plugwise developed the commissioning tool, which mainly moves toward improved usability of the luminaires (Figure 1, top) [2]. The application provides a large variety of use cases; for example, it can easily change the colors of the luminaires with only one click on the color palette on an iPad or other iOS- or Android-driven devices. Furthermore, the app makes it easy to set up a schedule for the luminaires so they provide varied light colors and intensities in each specified time frame (e.g. 30 seconds purple, 30 seconds orange). The data can be put in manually, but a Bluetooth QR-scanner may also be used to scan the data of the luminaires. The QR codes may be printed or just shown on a computer screen.

The app is not only able to give commands to one single luminaire; there is also an option to group multiple luminaires and create

a hierarchical group structure. The size of the group can vary from just a few luminaires in a toilet to a large number of devices within the whole building. In each group, modules can be added and removed and specifics like vendor name and hardware version can be set. If a group is selected in the app a list of all its modules and a list of subgroups pops up and if a module is selected, the tool shows in which groups the module is present and the groups that a module belongs to can be added, removed and saved.

As background information it is important to understand that the commands are executed by a set of rules (based on an Excel file), which are triggered by events; an event might be initiated for example by someone walking in the office. The rules contain different levels of priority and the execution of a rule may result in new “luminaire settings” and “level (de-)activation”. Only the settings of the highest active priority level are displayed, when no level is active the luminaire is switched off.

Each device has its own set of rules and thus every QR code contains its own set of rules. A standard set of rules is applied to each added module, which means that when presence is detected all the electricity turns on in the specific group and if absence is detected, all electricity switches off. In this way energy consumption is reduced, which was one of the great challenges of the project.

Local User Control

Legrand developed a local user control in order to give capabilities to locally provide input to the luminaries (Figure 1, top).

Two kinds of ZigBee end device systems were introduced:

- A wall switch able to be installed and fixed wherever the end user wants
- A table remote control

Both run on batteries. In addition to the ZigBee EnLight Profile embedded in these devices and compared to other solutions on the market, Legrand improved ZigBee commissioning management reliability within the proposed architecture.

Modifications done on the commissioning sessions were as follows:

- Return to factory configuration functionality: allows deleting all bindings which are initiated between the ZED (ZigBee End Device) and its ZigBee Router (ZR)
- Auto Remove functionality: after a commissioning session, products are working in a normal use mode. In case a ZR is not able to join, after several attempts, the ZED removes the ZR address from its binding table. As soon as this ZR has been removed from the binding table, the ZED sends a Subscribe Announcement signal to allow new ZR's to join or to allow the ZR which has been excluded from the binding table to re-join. This algorithm allows for an automatic clean-up of the binding table in case a ZR is broken or has been removed. It also allows a solution for RF communications issues which may occur
- Child - Parent Management: In terms of the ZigBee vocabulary, a ZED is the child and a ZR is the parent. Each ZED communicates with the ZigBee network through its parent. It is not mandatory that a child is bound to its parent. In case a parent is not seen by a child, the child has to manage a way to find another parent to talk with the ZigBee network. Moreover, the child also has to manage situations in which its previous parent is returning into the network. These situations are encountered when a power outage occurs during an installation

As a consequence of these measures communication reliability was increased.

People Tracker

Eaglevision developed a people tracker system [3] (Figure 1, bottom). This EagleGrid system is a marker-less 3D People Tracking System. It is a scalable network of small, people detection sensors, called EagleEyes, which are connected. These sensors cover large areas including complete floors in buildings. No tags like RFID, Bluetooth or other badges are needed. The system is based on stereo vision and advanced 3D imaging. The open network

interface to external systems makes it possible to process the tracks and other detected events.

The camera images are processed on the local processor and do not need a central server. This architecture avoids heavy network load and supports the "privacy by design" principle because server image storage is not required. In collaboration with our application partners complete applications and solutions are implemented.

Figure 2: Standing/sitting detection demonstrator. The lighting situation adapts automatically when a person is sitting down or standing up

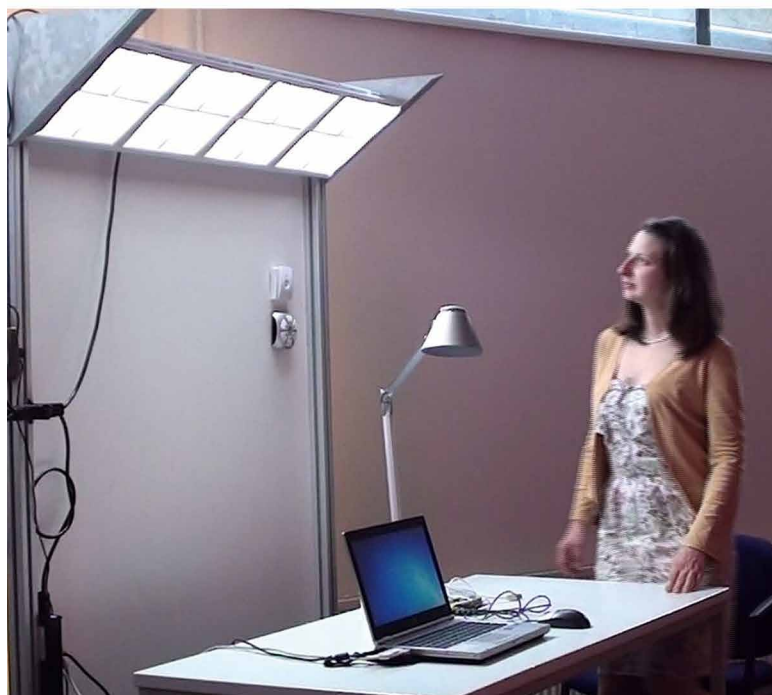
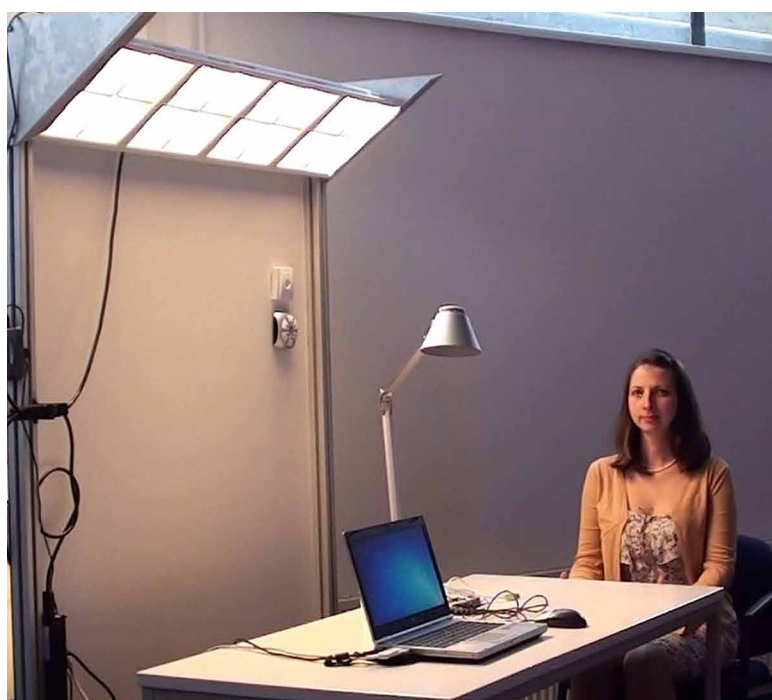

The tracking system can be used in all indoor places where people need to be tracked and safety events are automatically detected. The system respects people's privacy by design because the images are processed locally.

With the EagleEye stereo cameras 3D images are acquired and processed. By advanced algorithms individual persons are tracked in 3D and their route and poses over larger areas (including multiple cameras' field of view) are measured. Based on this method of tracking data, many applications are available such as direction sensitive counting of people in broad passages, detection of a fallen person, counting the exact number of persons in a room (for example for access control), measurement of queues and service times, and monitoring of human behavior (detection of elderly persons wandering in unsafe situations).

Within the project an office demonstrator was developed. The demonstrator reacts to human behavior as follows: in an office setting the lighting is modified automatically (in color and intensity) based on the pose of the person(s) in the illuminated neighborhood. In the demonstrator the lighting color moves from "reddish weak" to "blueish intense" when the person is standing up, for example to give a presentation (Figure 2). With this lighting configuration, the attention of the other attendees will be optimal and focused on the presenter. As soon as the person sits down again, the lighting returns to the original situation for a more soft evaluation discussion.

This demonstrator stands for a large variety of possible use cases of the EagleEye as smart sensor integrated in an intelligent lighting system, creating a very smart building. Application areas are office, hospitality, retail, security and (home) care.

Motion Detector and Temperature/Humidity Sensor

Existing motion and temperature/humidity sensors from Plugwise/AME were adapted to support the EnLight functionality and ZigBee communication protocol [4] (Figure 1, bottom). The sensors were battery powered devices and therefore act as sleepy end devices according to the ZigBee specification. They rely on the luminaire in the neighborhood to act as their ZigBee "parents". The sensors are in deep sleep (no radio) as long as there is no detection of an EnLight event. As soon as a relevant event occurs, i.e. detection of movement or a timer for reporting, the sensor wakes-up, gathers the event data (typically light, motion temperature or humidity measurements), switches on the ZigBee radio and sends the event via its parent luminaire over the air to the subscribers. Please note that this fits seamlessly in the EnLight model as described before.

Both the motion detector and the temperature/humidity sensors offer the following common functionalities:

- Leave the old network and join new network upon network button press (> 7 seconds)
- Announce to other devices in the network upon a button press to allow configuration and subscription
- Configure operational parameters such as "reporting period", "humidity delta reporting threshold" or "absence timeout"
- Report measured data on a periodical basis in the form of EnLight events

The motion sensor offers:

- Subscription on presence events, absence events
- Subscription on periodic reporting of light measurements and presence
- Notification of presence and absence (no presence for a configurable amount of time) to subscribers

The temperature/humidity sensor offers:

- Subscription on periodical reporting of temperature and humidity measurements in the form of EnLight events
- Reporting conditionally based on a change in measured values for temperature and humidity. For example, the temperature is only reported in case the measured temperature deviates more than 5°C from the previously reported value

CMOS Camera

Within the scope of the project, Fraunhofer IIS/EAS developed a low-power presence detector, based on an image-sensor system-on-chip (SoC) [5]. In contrast to traditional solutions, such as passive infrared (PIR) sensors, this system processes the image in the visible and near infrared spectrum, and derives texture features from visual information. A self-learning multi-modal algorithm analyzes the scene at a frame rate of up to ten frames per second. People can be localized within the field of view and distinguished from technical objects according to the active area and typical motion. In contrast to gray-scale algorithms the chosen approach is highly tolerant to brightness variations occurring due to incoming sunlight or switched luminaires.

We performed tests using a hardware / software prototype based on a commercial image sensor as well as an FPGA-implementation of the processing-pipeline (Figure 3, left), and simulations. They show the reliability of the method. Moreover, the experiments demonstrate that a high-dynamic-range image acquisition increases the effectiveness even further, especially for mixed lighting with the inclusion of sunlight or shadows.

These findings, as well as the algorithmic approach, contributed to the development of the new

Figure 3:
Demonstrator of the presence sensor (left) and image sensor SoC with integrated low power data processing (right)

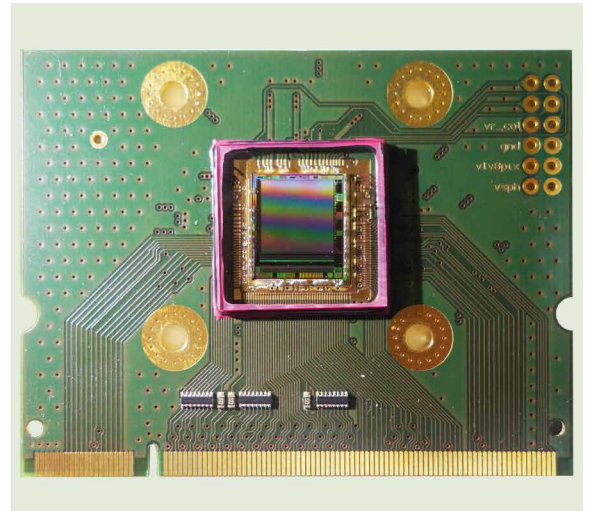

presence sensor with a novel smart high-dynamic-range image sensor SoC (Figure 3, right). It features a linear-logarithmic characteristic with more than 120 dB dynamic range, and was developed using Fraunhofer's proprietary charge-based mixed-signal sensor-processor platform [6]. The integrated application-specific instruction set processors (ASIP), and the column-parallel processing units have therefore been enhanced for the extraction of texture features.

The internal image-processing has a number of advantages for the presence sensor. The on-chip feature extraction leads to a significant reduction of data to be transferred and reduces the computational effort for the external general-purpose processing unit. A reconstruction of original images outside the image sensor is rendered impossible.

Three key benefits:

- "Privacy by design"
- External processing effort is very low so that a small micro-controller can be used
- Thus the total power consumption is very low

For the sensor with optimized software components on both the image sensor SoC and the micro-controller, a total power consumption of 100 mW is realistic without restricting functionality and comfort.

After installation of the sensor, various regions in the room are configured in the software so that, depending on the location and characteristics of recognized movements, events are issued. By their logical combination it is possible to detect whether a door was opened, whether somebody entered or left the room, where movement is located and how intense it is. The different scenarios are used to control the illumination and window shading according to user requirements. At a desk close to a window, glare can be avoided, and the lighting adjusted depending on what the user is doing; for example reading or working with the computer. In a domestic environment, the color temperature can be adjusted according to the movement and the time of day. In addition, adjustment is possible of the intensity and distribution of light depending on whether the residents are eating, sleeping or watching TV.

Infrared Presence Sensor

In the frame of the project a new kind of presence sensor was developed by CEA Leti (Figure 1, bottom). It is based on a thermal IR (Infrared) sensor that is able to detect presence under arbitrary lighting conditions (daylight, night, etc.) [7]. Detection considers both still and moving people. This development fills the gap between the low-price - low pixel size

detectors (PIR, thermopiles, etc.) and the high-price - high pixel size IR imagers (μ -bolometers).

The new IR μ bolometer based presence sensor was developed on two parallel tracks: the first one is the development of low complexity detection algorithms (low-level and high-level), and their implementation on the demonstrator that was specifically developed for the project. In this prototype the detection algorithm provides semantic descriptors to the output, preserving intrinsic privacy. The low-level algorithms were designed to avoid thermo-electrical coolers. They enable shutter-less operation of the sensor with fixed pattern noise removal. They are robust to environmental temperature variation, and self-commissioning. The high-level algorithms allow very low complexity target detection: the result of the detection process is provided at the output by semantical descriptors. The result of such detection is illustrated in figure 4, where each square stands for the detection of a person through a dedicated android application developed for the project.

The second track was on the development of a specific integrated circuit. The application specific integrated circuit for autonomous low-cost, low-power steady presence sensing and counting was successfully fabricated on a general-purpose 130 nm technology

from Altis semiconductors. The wafers were post-processed in the MINATEC clean-room facility for the implementation of IR bolometers MEMS. The integrated circuit with the IR bolometers built on top forms the sensor focal plane array. The latter is a 128x128 pixel matrix with 128 SIMD RISC processors and 128 application-specific ADCs (patented). A general purpose instruction set is implemented inside the processors which allows a broad range of applications and reduces system cost. Moreover, on-chip processing avoids image transfer and saves power.

The circuit proved its ability to perform privacy-compliant fully-digital thermal image acquisition and on-the-fly processing. Benchmarking with latest commercial products and articles in literature show a power consumption reduction of more than ten times using this new, dedicated integrated circuit (around 0.5 μ W/pixel).

Conclusion/Summary

All sensors for the Enlight system that were discussed in this paper concentrate on the important question of presence of people to provide the correct amount of light at low cost and by avoiding impact on privacy of the persons in the room. The technical concepts are different and range from motion sensors, via Infrared presence detection up to cameras in the visible light. In the demonstrators, the interface to the system was based on wireless ZigBee technology. In principle, wired implementations are also possible, and may be used in future applications. Information from the sensors is provided to the network by 'events' generated by the sensors, but no decisions are made at this level. This information may be used and decisions indeed made on the amount and color of light provided by any luminaire or other device in the network.

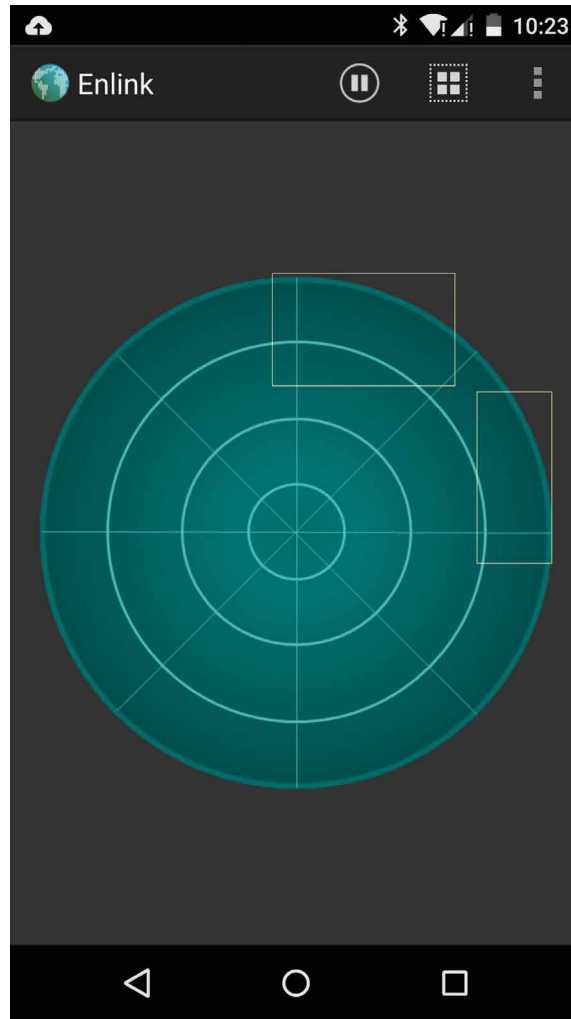

Figure 4: Results of the detection process; each square stands for a detected person

The Enlight architecture is, of course, not limited to presence detection. Indeed, it provides a very powerful means for control of home environments in general, in times when energy saving is an important topic and electronics for control purposes becomes extremely inexpensive. ■

References:

- [1] "System Architecture for Distributed Intelligence", Alex James, Martin Creusen and Micha Stalpers; LED Professional Review, Issue 48, 2015. Page 72
- [2] Plugwise: <https://www.plugwise.com>
- [3] Eagle Vision Systems bv (www.eaglevision.nl): the EagleEye people tracker
- [4] Plugwise/AME: <https://www.plugwise.com/>
- [5] Fraunhofer IIS/EAS, <http://www.eas.iis.fraunhofer.de/>
- [6] Jens Döge, „Ladungsbasierte analog-digitale Signalverarbeitung für schnelle CMOS-Bildsensoren“, Dissertationschrift, TU Dresden, Dresdner Beiträge zur Sensorik, 32, Dresden, 2008.
- [7] CEA Leti: <http://www-leti.cea.fr/>

Granular Lighting Control Enables Significant Energy Savings with Optimized User Comfort

While the last generation of LED lighting products is already very advanced with respect to energy savings, quality and end-user experience, these are still important topics and therefore also parameters on which the EnLight project needs to be evaluated. Eveliina Juntunen from VTT, Frank van Tuijl from Philips Lighting, Herbert Weiß from Osram, and Ambali Talen from Philips Research provide insight on the results of the demonstration installations in comparison to current state-of-the-art lighting systems.

In the course of the project, real-life demonstration pilots of intelligent lighting systems were developed in three locations in Europe. In this article these implementations of the EnLight intelligent lighting system are described. The performance was evaluated by comparing the installations with a baseline of state-of-the-art lighting systems. Validation concentrates on measuring the energy consumption and illumination at the pilot installation sites. In order to validate the light quality, end user acceptance was evaluated with user surveys. The goal of the project was to achieve 40% energy reduction compared to today's LED retrofit systems without compromising light quality and user comfort. The main results are discussed in this article with some considerations for future development.

Description of Demos

The real-life demonstration pilots focused on office and hospitality applications with a broad range of functionalities in indoor lighting scenarios. The implementation relies on control system intelligence to provide the right light in the right amount at the right place and at the right time. The energy-saving strategies applied in the project are summarized in (Table 1). The general energy-saving strategy was to adjust the lighting according to the presence of people and the available amount of daylight. With wireless communication and multiple sensors integrated into the demo space, people's presence and the availability of daylight could be detected locally and with a granular 'light only when needed' strategy, significant energy savings was achieved. Experiments with circadian rhythm lighting were also done in both the office and the hospitality environment. Additionally, personal lighting control with push buttons and desk lights was implemented for energy-saving and user comfort reasons.

The largest demonstration pilot was built by Philips at the High Tech Campus in Eindhoven, the Netherlands, with more than 120 luminaires along with other dedicated infrastructure elements, such as external sensors, user controls, and energy meters. The demo area consisted of an open plan office, corridor and meeting room. The demo area was well populated with office employees and had good access to natural light with big windows, especially in the open plan office space (n=24).

The VTT Technical Research Centre of Finland also built an office pilot in its multifunctional meeting, working and lounge space in Oulu, Finland. Compared to the office pilot in Eindhoven, the implementation was smaller with 43 luminaires among other infrastructure needed for sensing and control. The occupancy in the VTT pilot space in Oulu was lower and there was less natural light available than in Eindhoven, which provided a diversified perspective for the office demonstrations.

| Application | Task tuning | Personal control | Occupancy | Time schedule | Daylight harvest | Load shedding | |
|-------------|--------------|-------------------------|---|---|------------------|--------------------|---|
| OFFICE | Open office | Ambient / task tuning | Desk light | Local occupancy sensing with a light bubble | Sunrise rhythm | Local constant lux | √ |
| | Meeting room | 5 scenes | Scene selection with a push button | Local occupancy sensing | - | - | - |
| | Lounge | 4 scenes | Scene selection with a push button | Global occupancy sensing | - | - | - |
| BOTH | Corridor | - | - | Local occupancy sensing with a light bubble | Office hours | - | √ |
| HOSPITALITY | Guest room | 4 scenes and CCT tuning | Scene selection and CCT tuning with a push button | Local occupancy Sensing | - | - | - |
| | Rest room | 4 color temperatures | CCT selection with a push button | Local occupancy sensing | - | - | - |
| | Lobby | - | - | Local occupancy sensing | - | - | √ |

Table 1: Energy-saving strategies of the demos (“-”: Feature not available)

The hospitality demonstration pilot was built by Osram in Garching, Germany. The demo comprised a guest room, a corridor, a restroom, and lobby areas. The lighting system was also of significant size with nearly 100 luminaires, controls and monitor components installed in total. The demo area had no access to natural light except for the guest room which had only a small window with limited daylight contribution. Test persons frequently used the installation, in particular the guest room for making a break, relaxing, chatting or working. However, no overnight stays like in a real hotel could be hosted.

Saving Energy through Distributed Intelligence

The intelligence in the EnLight system was based on a granular, location-specific approach to sensing with high local accuracy. As an example, a ‘light bubble’ concept was developed for lighting the open plan office and the corridors. In the open plan office use case, the primary design objective was the reduction of energy consumption while providing good quality and comfortable lighting to

office workers enabling them to do their daily tasks. In the corridors the same concept was used for reducing energy consumption while maintaining the impression that the corridor lighting is always on.

The following control strategies were applied when implementing the light bubble concept:

- A light bubble around the luminaires that detect the presence of people
- A low background lighting level is applied if there is someone present in the area
- Smooth brightness transitions with low fade rates are used to hide differences in the brightness of luminaires
- In the office use case, personal control is facilitated by a desk light, which can be activated manually when the user wants to increase the light on the work surface
- In the corridor use case, the ends of the corridor are lit to suggest that the lighting in the corridor is always on. Also, external presence sensors are applied to turn on the lights before the user arrives in the empty corridor and sees it completely dark



Figure 1: Demo areas: Open plan office at Philips, Eindhoven (top), multifunctional office space at VTT, Oulu (middle) and hospitality guest room at OSRAM, Garching (bottom)

Figure 2:
Simulation of the corridor with a light bubble control concept

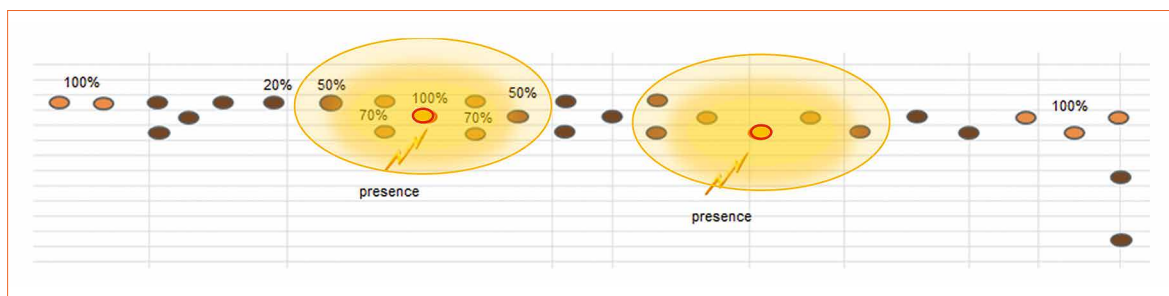

Figure 3:
Measurement grid (left) and illuminance map (right) in the meeting room in the office demo

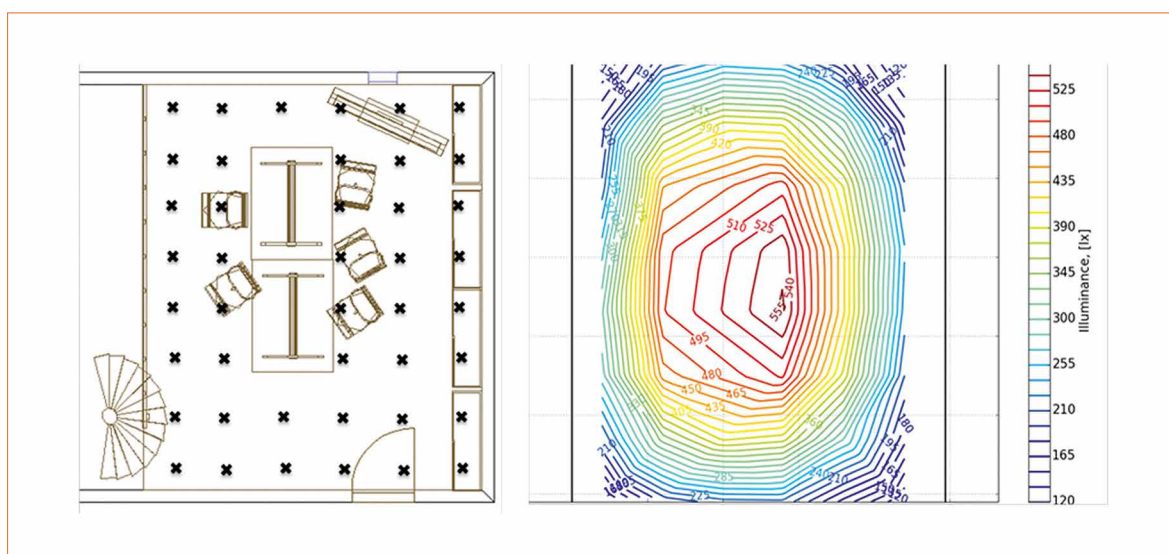

Figure 2 shows a snapshot of the simulation of the light bubble in the corridor. The bubble was used to create a smooth transition from 100% brightness towards background level (20%). The luminaire that detects the presence of people sets its brightness to 100% on a high priority level. The neighboring luminaires were set to 70% on a lower priority level and the far neighbors have an even lower priority level for setting their brightness to 50%. In case of overlap the highest level will win. In the real-life demos, in most cases the bubble was hardly visible because in practice several bubbles overlap.

The bubble turns to background brightness (20%) after 2 minutes of not detecting motion. The measurements in the demo installations showed significant energy savings with this kind of granular control strategy. For example, in the office application 30% energy savings was shown in the corridor compared to a traditional system with global presence detection.

User Comfort - a Matter of Quality

In this project, it was not an option to compromise the quality of light in order to increase energy efficiency. Therefore both photometric measurements and user surveys were carried out at all the pilot sites to guarantee user acceptance of the developed lighting system.

Photometric measurements

To evaluate the lighting on flat surfaces, such as a table or floor, illuminance in the demo areas was measured with a lux meter. A grid defining the specific measurement points over the demo area was used as shown in an example in (Figure 3). The illuminance is indicated with colors (lx) shown in the color palette at the right. Other photometric quantities such as CCT, CRI and color coordinates could be recorded during the measurement as well. In addition, luminance in the open office pilot was measured using a luminance camera with a fish eye lens.

The photometric measurements showed that the developed lighting system gave functional and nicely distributed illumination in the pilot office and hospitality environments. The measurements also showed that the proposed new system can provide the same light level and light distribution as the baseline of state-of-the-art lighting systems used as the reference in the performance comparison.

End user feedback

The overall user experience was evaluated with validated questionnaires made available to the users of the pilot areas. The questionnaires focused on visual comfort, room appearance and personal control in the demo space. In addition, face-to-face interviews were carried out to collect more detailed feedback of the installation. An example of the results is shown in (Figure 4) below.

In general, the quality of light was evaluated to be at a good level in all the demonstration pilots.

Although statistically significant improvements in comfort were only shown for some particular aspects, qualitative analysis showed an increase in user comfort compared to state-of-the-art lighting systems used as a reference. In particular, non-conventional LED luminaires (“New Form Factor Luminaires and New Light Effects” - article) scored especially high in user preference in the hospitality environment. Thus, based on photometric measurements and user tests carried out in the project, it was concluded that the energy savings were not attained at the expense of light quality.

The user studies revealed that good communication and awareness of the benefits are important when introducing new lighting control systems. In conclusion, the majority of end users preferred the new system over the state-of-the-art reference for saving energy and maintaining a good quality of light.

Furthermore, taking care of smooth fading times is essential, since noticeable changes in the lighting settings were experienced as disturbing. User control with modern push buttons and desk lights was discovered to be important for user acceptance in the office because, in general, people like to have control over changes. The desk light,

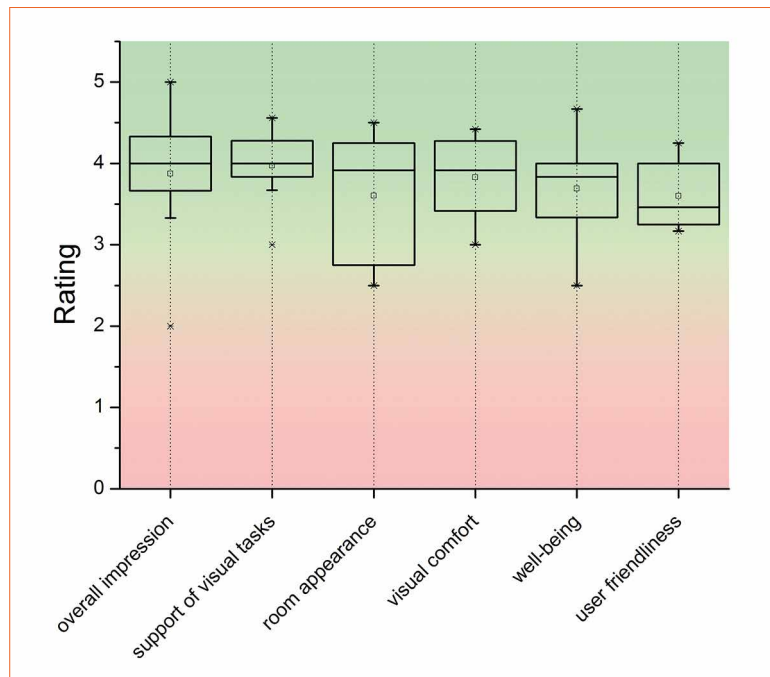

Figure 4: User rating of the hospitality installation. The rating scale ranges from 1 (very bad) to 5 (excellent)

for example, was well appreciated because it enables a user to adjust the amount of light according to personal preferences when needed.

After becoming accustomed to the algorithm and understanding it as an effective way to save energy, almost none of the users complained about the smart control causing darker spots in the demo area when only a few people were present. The light bubble in the corridor was only noticed by those who arrived first early in the morning or left late in the afternoon. The feedback was positive as they were charmed by this energy-saving approach.

Energy Savings: Metrics and Measurements

The Lighting Energy Numeric Indicator (LENI) described in the EN 15193: Energy performance of buildings - Energy requirements for lighting standard was used as the indicator of the energy performance. LENI describes the annual energy consumption of the lighting (kWh/m², per year) taking into account the power of the luminaires and the parasitic systems.

The energy savings were validated by comparing the developed system with the baseline installation of state-of-the-art lighting technology in an identical demo area.

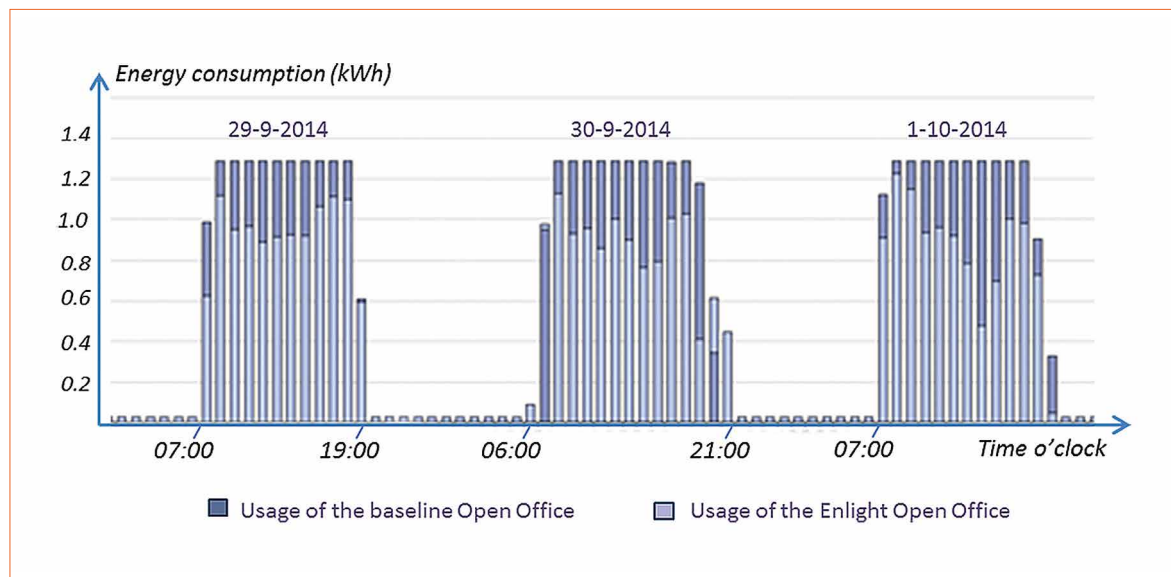

Figure 5: Energy consumption of lighting in the baseline system (dark) and the EnLight system (light) recorded on an hourly basis

Figure 6:
LENI results measured for both test installations in the office application

The power consumption was measured and the LENI was calculated for both the baseline and the EnLight installation. Examples of measurement data in the office demo are shown in (Figure 5). The occupancy and daylight supply in different spaces with variable control strategy were also taken into account in the LENI calculations. Thus, it was possible to find out the differences in the energy performance in different situations.

Overall Energy Saving Results

The main goal of the project was to achieve more than 40% energy saving compared to state-of-the-art lighting in real-life demonstrations. This target was accomplished in both the office and hospitality applications. Furthermore, the energy performance was compared against regional building energy performance benchmarks [1, 2, 3, 4] to bring the results in a wider perspective.

Table 2:
Energy benchmarks of the office installation

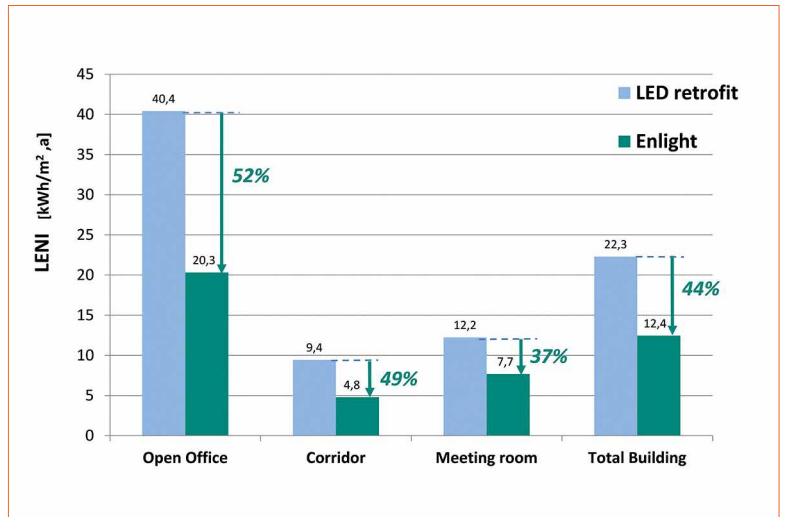

| Normative benchmarks LENI [kWh/m ² , a] | EN15193 Office ** | ASHRAE 90.1 | LEED 18 pnt credit | Title 24 | EnLight Granular control |
|---|----------------------|----------------|--------------------------|----------|--------------------------------|
| Open office | | 37.6 | 20.3 | 25.4 | 20.3 |
| Corridor | | 23.0 | 12.4 | 25.2 | 4.8 |
| Meeting room | | 25.7 | 13.9 | | 7.7 |
| Total building | 45.5 | | | 27.1 | 12.4 |

Office

The baseline reference for an office application was a lighting installation which used retrofit LED lamps, such as TLED, LED Spot, and LED bulb, retrofitted into traditional office luminaires designed for incandescent and fluorescent lamps. No daylight regulation was exploited, but a commonly used automatic on/off control strategy based on global occupancy sensing per area with a switch-off delay of 15 minutes was used in the baseline.

The meeting room and open office measurements of the baseline and the EnLight installation were running in parallel in twin areas with identical room characteristics and occupancy. The corridor measurements were alternated in time between the EnLight and the baseline system in the same installation area. The task light illuminance levels for both test systems were designed to be the same - in case of a small

measured difference in the illumination and occupancy between the systems, the energy data were corrected. The measurements were conducted in the period from calendar week 24 (June) to week 44 (October) in 2014 and were extrapolated to yearly energy use without seasonal corrections.

The office pilot demonstrated total energy savings ranging from 37% for the meeting room to ~50% for the corridor and open office, compared to the state-of-the-art retrofit LED lighting systems as a reference. Thereby, the contribution of the granular control strategy ranges from 26% (meeting room) to maximum 37% (open office) improvement. The overall lumen efficacy on luminaire level has improved with more than 20% from 76 lm/W to 96 lm/W.

As the resulting energy saving for the total installation was 44%, the goal of the project was accomplished. Figure 6 shows the absolute LENI numbers measured for both systems for the open office, corridor and meeting room areas. With EnLight, the LENI number for

the total office area was reduced to 12.4 kWh/m² per year from 22.3 kWh/m² per year shown for the LED retrofit baseline.

The EnLight system energy performance was compared to the regional energy building performance standards EN15193:2007 [1], LEED [2], ASRAE 90.1 [3], Title24 [4]. The results are summarized in table 2. All energy values were calculated from the measured occupancy data and the applicable Lighting Power Densities given by the standards. In conclusion, the LENI results (i.e., 20.3 kWh/m² per year) were approximately 20% better than the Title 24 Lighting Power Density (25.4 kWh/m² per year) in case of large office areas. Compared to the ASHRAE requirements, the results were more than 46% lower which results in a maximum LEED score of 18 points. The current European EN15193:2007 standard provides the least stringent performance benchmark figures with values almost 400% higher than the demonstrated LENI performance.

Hospitality

Like in the office demonstration pilot, the baseline reference to which the EnLight luminaires and their energy consumption in the hospitality application was compared consisted of LED lamps retrofitted into traditional luminaires designed for incandescent and fluorescent lamps. Non-conventional luminaires described in the “New Form Factor Luminaires and New Light Effects“ article were exploited in the demo. Such luminaires make full use of design possibilities which arise with LED technology and can thus hardly be realized in a retrofit approach. Nevertheless, state-of-the-art lighting technology retrofitted with LED lamps with only on/off control was assumed as a basis for the estimation of baseline performance.

Energy measurements were carried out over several weeks in a similar way as for the office installations. Test persons used, interacted, and judged the whole installation. Usage hours which are relevant for deriving LENI numbers were nearly the same as given in the EN 15193 standard [1]. Energy monitoring measurements of the EnLight installation revealed an overall energy consumption of 20.2 kWh/m² per year (Figure 7). Compared to the LED retrofit baseline, this corresponds to savings of 81% which is largely above the target. Even if savings compared to the LED retrofit baseline with only on/off control (savings of 42% in Figure 7) would have been overestimated, 67% savings were still gained exclusively due to intelligent control.

Broken down into the different areas of the hospitality demo, the savings by control amounted to about 50% in the corridor and restroom. In the lobby, no savings could be realized, since luminaires had to run all day long in this area. Most significant savings, namely 80%, were realized in the guest room. In order to provide a large range of scene and light level setting options, the installed lighting power density was especially high in this area. This would be highly detrimental for installations with

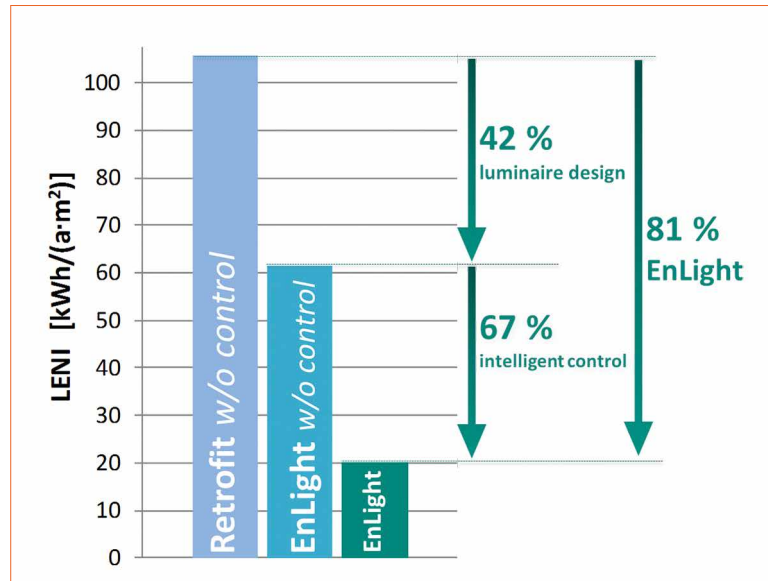

Figure 7: LENI results of the EnLight hospitality installation. For the data without intelligent control, occupancy factors given in EN 15193 are assumed

| Normative benchmarks LENI [kWh/m ² , a] | EN15193 Hotel Quality Class *** | ASHRAE 90.1 | LEED 18 pnt credit | Title 24 | EnLight |
|---|--|----------------|--------------------------|----------|---------|
| Corridor | | 37.9 | 20.5 | 26.0 | 15.4 |
| Restroom | | 22.6 | 12.2 | 30.5 | 10.9 |
| Guest room | | 38.7 | 20.9 | 52.2 | 29.4 |
| Lobby | | 58.1 | 31.4 | 60.1 | 50.6 |
| Total hospitality area | 108.1 | | | 36.7 | 20.2 |

Table 3: Energy benchmarks of hospitality installation

basic control. However, using the interactive and granular control, the light was adjusted to the right level at the right time and energy was drawn only as much as required by the users' needs.

Compared to energy savings demonstrated with the EnLight office installation, the savings shown with the hospitality demo were especially high. This is due to the fact that for decades a strong focus in office luminaire development has been on highest efficacy levels. This is not true for hospitality applications in which a large focus is still on decorative elements that often counteract good efficacy. Dedicated designs as they were applied in this project provided large efficacy gains.

Also, the lighting power density installed in hospitality environment is usually much higher than in office areas. Consequently, there is good potential for energy savings with intelligent control as demonstrated with these results.

Similar to the office demo, the hospitality installation compared well with the most stringent international standards. The installation performed 45% better than the Title 24 standard for hospitality applications and exceeded ASHRAE 90.1 requirements by an average of 46%. A LEED score of 18 points was therefore achieved. Table 3 gives an overview of the LENI benchmark in detail.

Recommendations and Future Work

It was shown by the validation results that the right metric for energy consumption of lighting systems should be based on actual energy usage per area and per year (i.e., kWh/m² per year). Therefore, the Lighting Energy Numerical Indicator (LENI) is a more suitable energy performance metric than commonly used installed lighting power (W/m²). The validated energy savings are an important stepping stone to realize the EU directive

2010/31/EU of the European Parliament and of the Council for a near zero energy performance of buildings in 2020. More stringent LENI benchmark numbers than in the current EN15193:2007 standard would be instrumental to achieve that goal.

At the moment, dynamic lighting systems are relatively new to the lighting industry. Development of dynamic lighting systems requires a combination of automated and personal control. Introduction of novel granular lighting control and sensors embedded in luminaires facilitate significant energy savings and user comfort enhancements.

However, end-user acceptance of high-end 'activity' sensors will require corresponding algorithms to enable unobtrusive implementation.

In the future, companies should further strive to limit energy consumption of stand-by power, ahead of future legislation. Joint activities in standardization bodies may guide to a stable market acceptance and therefore growth. Also, further research and validation of effects of human-centric lighting on health impacts of dynamic lighting - e.g. impacts on productivity in office lighting and also on psychological stability - should be addressed.

Summary

In the EnLight project, intelligent lighting systems for office and hospitality applications have been developed that demonstrate significant energy savings of 44% - 81% compared with state-of-the-art LED retrofit systems while maintaining, or even increasing, user comfort. These results have been achieved by using sophisticated energy-saving strategies, such as task tuning, personal control, and granular occupancy sensing. ■

Figure 8:
"Wedge Wall"
luminaire, CCT tuned to
neutral white and warm
white

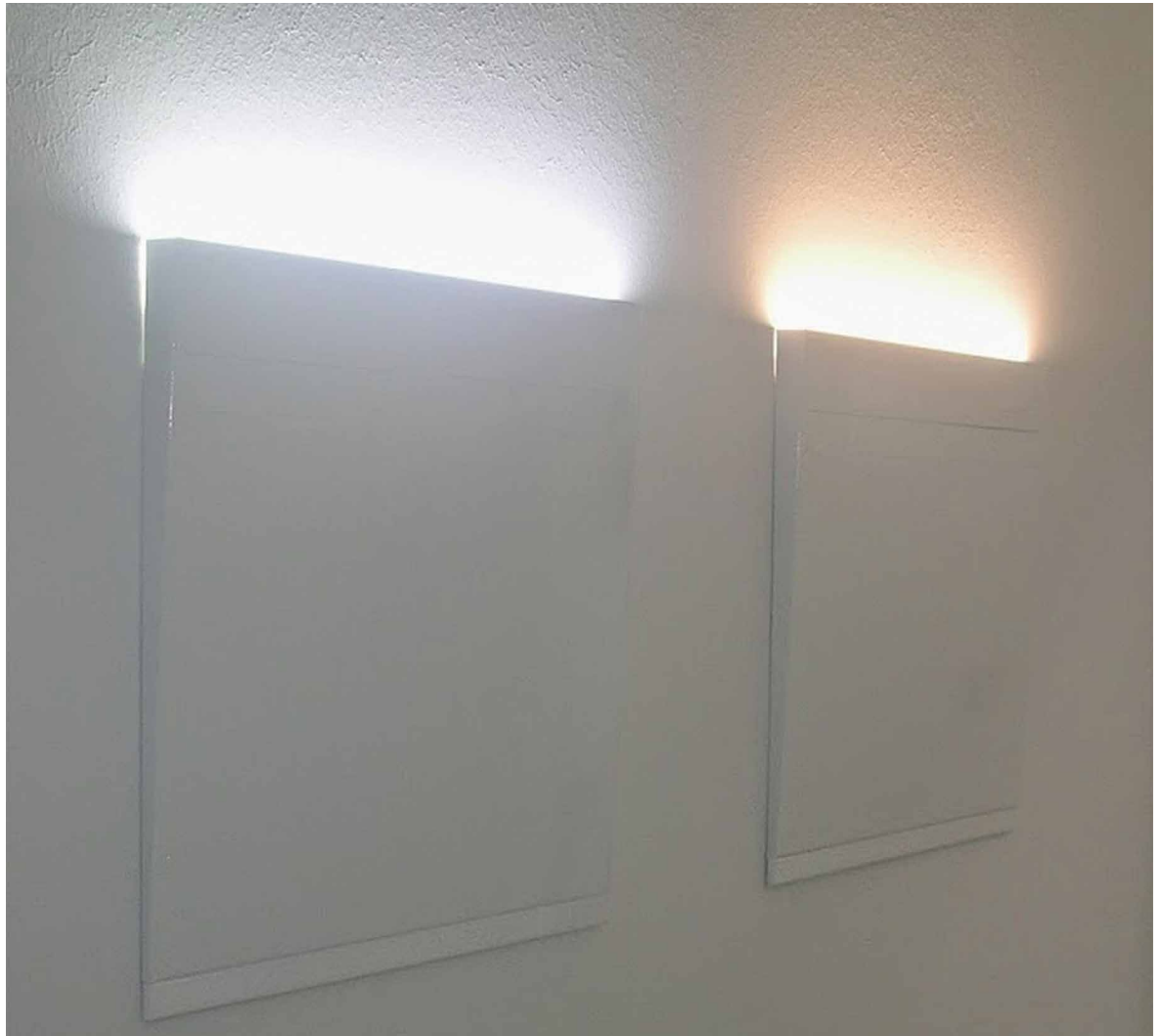

References:

- [1] EN 15193:2007 Energy performance of buildings — Energy requirements for lighting
- [2] Leadership in Energy and Environmental Design (LEED)
- [3] ANSI/ASHRAE/IES Standard 90.1-2007
- [4] <http://www.energy.ca.gov/2012publications/CEC-400-2012-004/CEC-400-2012-004-CMF-REV2.pdf>

LpS 2015

LED SYMPOSIUM
professional +EXPO

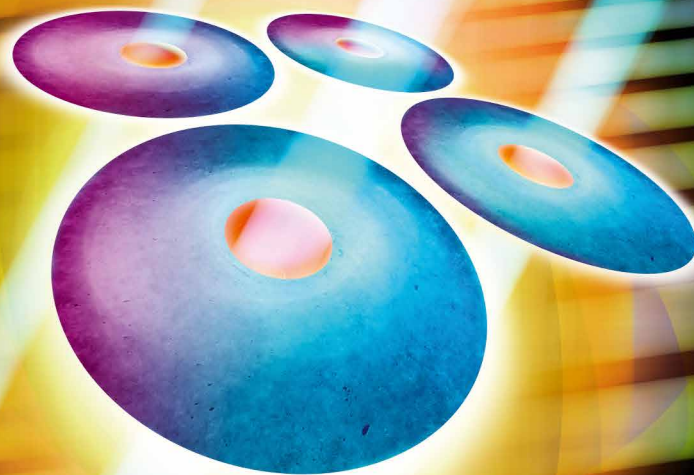

LED professional Symposium +Expo

Design and Engineering for Future LED Lighting Systems

SEPT 22ND - 24TH 2015 | BREGENZ | AUSTRIA

www.lps2015.com



LED professional Review (LpR) - Annual Subscriptions

LpR Digital Magazine

- 6 issues
- pdf download
- high resolution pictures and graphs
- printable
- commercial use
- access to all previous issues
- Euro 78.80

LpR Printed Magazine

- 6 issues
- Euro 158.40

<http://www.led-professional.com/subscription>

Cover-page

Artwork: Thomas Klobassa,
©LED professional 2015

Main Image: Arno Grabher-Meyer,
LED professional

Product: Code Mercenaries LED-Warrior 04 and Carclo optics



Symbolic arrangement of an intelligent human-centric LED lighting solution

Next LpR Costs & Processes Issue 49 - May/June 2015 - Short Overview

TECH-TALKS BREGENZ

Daniel Doxsee - Deputy Managing Director at Nichia Chemical Europe

Nichia is arguably the company with the longest history of manufacturing white LEDs. Recently, however, new competitors, especially from China, have started challenging Nichia's market share. Nichia's role, in solid-state lighting strategic and technical issues, past, present and future, were discussed. ■

TECHNOLOGIES

Designing and Manufacturing with Flip Chip COBs

Recent development of LED flip chip on board has demonstrated its advantage in lower thermal resistance and lower packaging cost over the traditional wire-bonded LED COB. A new approach, a 3-Pad LED flip chip COB that was invented to further reduce the thermal resistance is described. The advantages are discussed based on an example and hints for designing and manufacturing are given. ■

Thermal Management Substrates for COB LEDs

The benefits to LEDs when their temperatures are kept as low as possible include increased lifetime, better efficiency, the ability to reduce design costs and the ability to run fewer LEDs at higher power. Constructions for low, medium and high power LEDs are discussed in this article and specific types of thermally conductive substrates examined. ■

Advanced Materials to Support Solid State Lighting

LED technology has matured into a robust and efficient way of lighting, while OLED still holds promise based on light quality. The refractive index (RI) mismatch is one important reason that the optical performance of both is well below the theoretical maximum. The properties of high RI nanocomposite approaches and how they enable higher light extraction efficacy to improve LER are discussed in detail. ■

RESEARCH

"Best Papers" at LpS 2014: Self-Compensation Approach to Reduce Color Shift of Phosphor Converted LEDs upon Temperature Variations

In SSL, white light generation mainly relies on a combination of blue LED light and excited emission from one or more phosphor materials. It is a big challenge to maintain chromaticity coordinates over temperature or lifetime. The article discusses how a combination of phosphors with appropriate optical properties can compensate color shift when the temperature changes. ■

subject to change

Imprint

LED professional Review (LpR), ISSN 1993-890X

Publishing Company

Luger Research e.U.

Institute for Innovation & Technology
Moosmähdstrasse 30
A 6850 Dornbirn, Austria / Europe
phone +43 5572 39 44 89
fax +43 5572 20 60 70
info(at)lugerresearch.com
www.lugerresearch.com

Publisher

Siegfried Luger +43 5572 39 44 89-70
s.luger(at)led-professional.com

Editor-in-Chief

Arno Grabher-Meyer +43 5572 39 44 89-18
a.g-m(at)led-professional.com

Research & Innovation Manager

Dr. Amrita Prasad +43 5572 39 44 89-19
amrita.prasad(at)led-professional.com

Int. Account Manager

Theresa Koenig +43 5572 39 44 89-20
theresa.koenig(at)led-professional.com

Marketing & Sales Manager

Katharina Fink +43 5572 39 44 89-43
katharina.fink(at)led-professional.com

Your Local Contacts

China, Hong-Kong

Iris Yuen +86 1380 27 01 367
irisyuen88(at)gmail.com

Germany

Armin Wezel +49 30 526 891 92
armin(at)eurokom-media.de

Japan

Eiji Yoshikawa +81 3 6751 0090
scala(at)s3.dion.ne.jp

South Korea

Jung Won Suh +82 2 78 58 222
sinsegi-2(at)sinsegi-media.info

Switzerland

Monika B. Ailinger +41 41 850 44 24
m.ailinger(at)marcomedia.ch

Taiwan

Leon Chen +886 2 256 81 786-10
leon(at)jkmedia.com.tw

United Kingdom, France & Benelux

Zena Coupé +44 1923 85 25 37
zena(at)expomedia.biz

US East

Karen C Smith-Kernc +1 717 397 7100
KarenKCS(at)aol.com

US West & Canada

Alan A. Kernc +1 717 397 7100
AlanKCS(at)aol.com

Copyrights - Luger Research e.U.

The editors make every reasonable effort to verify the information published, but Luger Research e.U. assumes no responsibility for the validity of any manufacturers, non profit organisations or individuals claims or statements.

Luger Research e.U. does not assume and hereby disclaims any liability to any person for any loss or damage caused by errors or omissions in the material contained herein, regardless of whether such errors result from negligence, accident or any other cause whatsoever. You may not copy, reproduce, republish, download, post, broadcast, transmit, make available to the public, or otherwise use LED professional Review (LpR) content without prior written consent from Luger Research e.U. - Institute for Innovation & Technology, Austria. ■

ILLUMINOTRONICA

HUMAN CENTRIC LIGHTING TECHNOLOGIES

PADUA - ITALY, 8-10 OCTOBER 2015

www.illuminotronica.it



LED 
LIGHTING

solutions & design

for those who design, manufacture
and supply luminaires and systems
for **outdoor** and **indoor** lighting

SMART HUT

*home automation
for
the human well-being*

products and technologies (hardware
& software) to manage and control
lighting e safety

elettro & micro

*up to date
on the electronics industry*

Assodel meeting point for
technicians and companies
**the unique event existing in Italy*



assodel



TECNO
IMPRESE

Small is Big



For Manual and
Automated Wiring Systems
2060



For Direct
Power System Feed-In
2061



For the
Smallest Sizes
2059

The Range of SMD Terminal Blocks

www.wago.com/SMD

WE
INNOVATE!



WAGO[®]