

Tech-Talks BREGENZ: Jy Bhardwaj

Research: Simulation of PC LEDs

Innovations: Modules, Electronics & Plastics

Events: LpS Review & Product Trends

Making LED Lighting Solutions Simple™



**We Accelerate
Time to Revenue
by Providing**

- ▶ **The Most Comprehensive System-Level Product Portfolio**
- ▶ **Solid-State Lighting Expertise**
- ▶ **Design Support Services**
- ▶ **Global Supply Chain and Business Solutions**



FUTURE
Lighting Solutions

www.FutureLightingSolutions.com

LpS 2016

LED SYMPOSIUM
professional +EXPO

Call for Papers

OPEN NOW!

www.lps2016.com/cfp

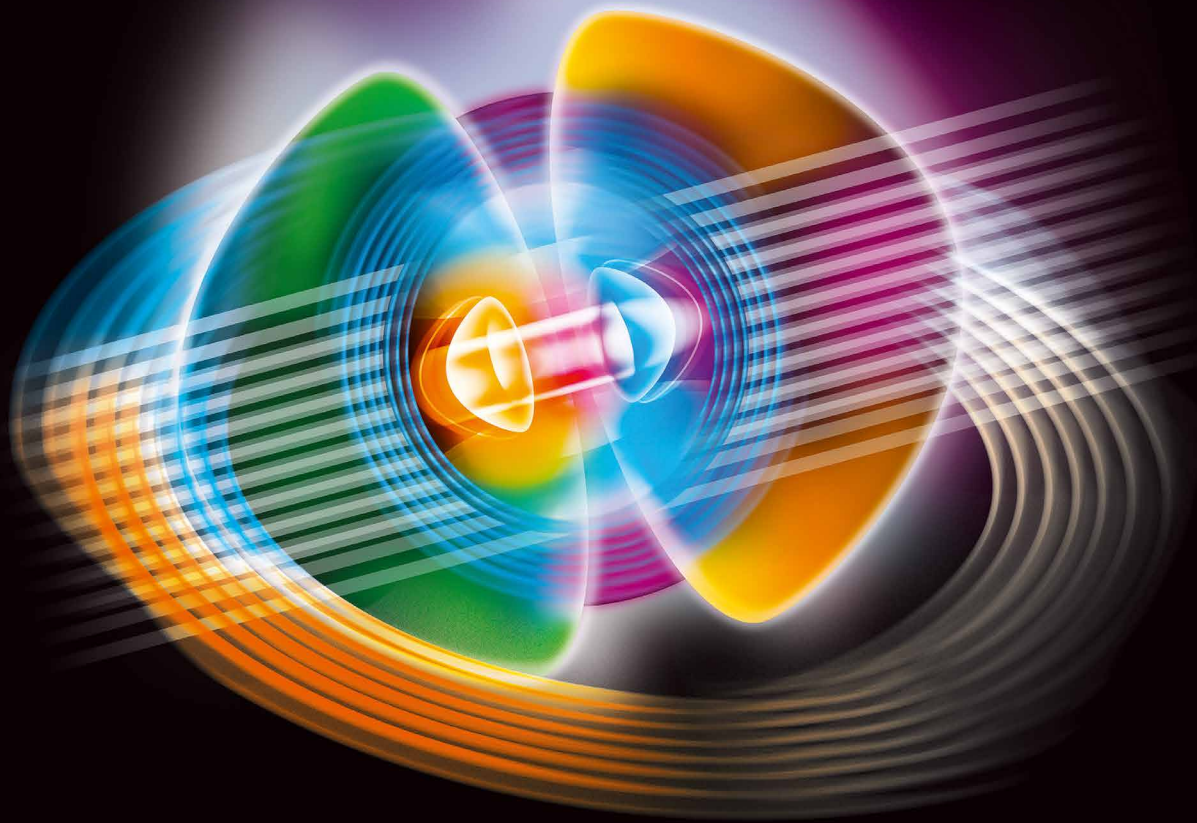

6TH LED professional Symposium +Expo

Smart Technologies for Lighting Innovations

Sept 20th - 22nd 2016 | Bregenz | Austria

www.lps2016.com

Organized by Luger Research e.U.

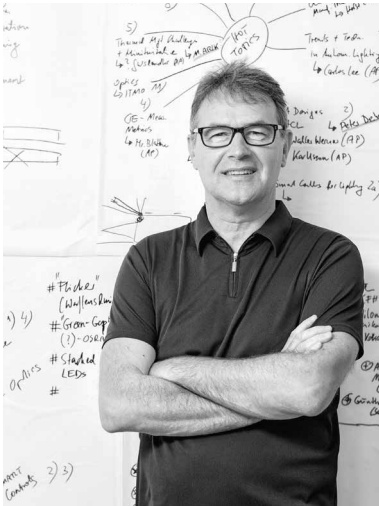

Trends & Innovations

The last LED professional Review in 2015 is dedicated to trends and innovations in solid-state lighting. This issue also concludes the International Year of Light. From September 22nd to 24th we had the chance to meet a great number of experts at the 5th International LED professional Symposium +Expo 2015 (LpS) in Bregenz - *the* place for shaping the future of lighting. This issue includes a comprehensive post-show report written by our editor-in-chief, Arno Grabher-Meyer that also highlights the products that were presented in Bregenz to the lighting market for the very first time.

Dr. Jy Bhardwaj, CTO at Lumileds, and one of the keynote speakers, revealed his way of thinking about the future of lighting. He discussed his ideas about the evolvement of light and lighting technologies with us, and summed it up into the concept of embedded lighting. While he was there, he agreed to do a Tech-Talk BREGENZ so we could go into further detail on how Lumileds, as a component manufacturer, approaches new trends and generates innovations.

Once a year LED professional also honors the LED professional Scientific Award at the LpS with a trophy and a check for 3,000 Euros. This year DI Wolfgang Nemitz from Joanneum Research was awarded for his paper about "Interactive Optical and Thermal Simulation Method for Proper Simulation of Phosphor Coated (PC) LEDs." Based on interactive, multidiscipline simulations, his research team was able to find new dependencies and design criteria for PC LEDs. This paper was presented at the LpS 2015, published in the proceedings booklet and is now available to LED professional Review readers.

At the LpS 2015 we also explored the building blocks for smart lighting designs. It is a common understanding that we're moving into intelligent, connected, self-controlled and regulated lighting but centered on the very individual needs of human beings or on the very specific needs of all the different applications. Internet, cloud solutions, sensors and electronics are inherently linked to all kinds of new solutions. The lighting system architectures of tomorrow will not be the same as today's. In this issue of LpR we cover some aspects such as software design, electronic driver topologies and driverless controls.

It's possible that in the future light will be everywhere; embedded in our surroundings, connected to the web, self-controlled, safe and finally offering ideal quality for the specific demands in and for our applications. SSL technologies, the internetization and the connected and digital world really revolutionize of how the world is lit.

As you probably agree, it's great to be part of these fascinating developments. Beyond these developments, process mechanisms, technical risks and financial risks are part of the business and need to be handled professionally. This issue also covers that part of the game. A part that might be forgotten when the wheels turn faster and faster.

Last but not least I would like to thank you for being part of the LED professional community and for collaborating with us.

The LED professional team wishes you a Happy New Year 2016!

Have a great read.

Yours Sincerely,

Siegfried Luger
CEO - Luger Research e.U.
Publisher - LED professional
Event Director - LpS 2016



DALI Intelligent LED Driver

✿ Group Controlling:

Standard DALI interface, realize the group control function via DALI system

✿ Mode Setting:

Sleeping, working, dining, meeting, relaxing and etc.

✿ Dimming range:

Freely adjust the brightness from 10%-100%.



DALI linear aluminum case LED driver



Features:

Input: 100-277Vac, limit: 90-305Vac.
 Output Power: 20-60W, main promoted output voltage: 27-42V.
 Performance:
 1. High PF (PF > 0.95 @ 230V); Low THD (THD < 13% @ 230Vac);
 2. Surge level: 2KV.

Application: LED tri-proof lights and other linear shape lights.



DALI plastic case LED driver



Features:

Input: 100-277Vac, limit: 90-305Vac.
 Output Power: 20-60W, main promoted output voltage: 27-42V.
 Performance:
 1. High PF (PF > 0.95 @ 230V);
 Low THD (THD < 13% @ 230Vac);
 2. Surge level: 1KV.
 Application: down lights, panel lights, track lights, grid lights and ect.



COMMENTARY

08 Lighting Beyond Illumination
by Heinz Seyringer, Zumtobel Group

TECH-TALKS BREGENZ

28 Dr. Jy Bhardwaj, Lumileds, CTO
compiled by Siegfried Luger, LED professional

EVENTS

32 LpS 2015 – Focus on Design and Applications for Sustainable Solutions
by Arno Grabher-Meyer, LED professional

42 LpS 2015 Product Showcase – Dominated by Product Launches
by Arno Grabher-Meyer, LED professional

RESEARCH

48 Iterative Optical and Thermal Simulation Method
for Proper Simulation of PC LEDs
by Wolfgang Nemitz et al., Joanneum Research

TRENDS

54 230 VAC Driven LED Modules with Strongly Reduced Flicker
by Wolfgang Endrich, euroLighting

60 Software Design in LED Lighting Applications
by Attila Tomasovics, Infineon Technologies

ENGINEERING

66 Predictive Simulation to Virtually Test Product Design and Reduce Time to Market
by Kersten Terry & Berend Hoek, Trinseo

SPECIAL

74 Boost-Buck LED Driver Topology for Low Input and Output Ripple for Low EMI
by Keith Szolusha, Linear Technology

REGULARS

04 EDITORIAL
08 COMMENTARY
10 PRODUCT NEWS
24 RESEARCH NEWS
26 REGULATION NEWS

82 ABOUT | IMPRINT

EVENTS

32 LpS 2015 – Focus on Design and Applications for Sustainable Solutions
by Arno Grabher-Meyer, LED professional



LED PROFESSIONAL SCIENTIFIC AWARD WINNER ARTICLE

48 Iterative Optical and Thermal Simulation Method for Proper Simulation of PC LEDs
by Wolfgang Nemitz et al., Joanneum Research



ADVERTISING INDEX

FUTURE LIGHTING SOLUTIONS	1	EVERFINE	19	HONGLITRONIC	53
FUTURE LIGHTING SOLUTIONS	2	TILS	21	WILLIGHTING	64
LPS 2016	3	WEB - INFINEON	22	LED LIGHT FOR YOU	65
LED FRIEND	5	FUTURE LIGHTING SOLUTIONS	23	LIGHTING JAPAN	73
DIGI-KEY	7	WEB - LAMBDA RESEARCH	24	DOW CORNING	77
LEDLINK	9	FUTURE LIGHTING SOLUTIONS	25	EVERFINE	80
INSTRUMENT SYSTEMS	11	FUTURE LIGHTING SOLUTIONS	27	FORUM LED	81
SHARP	13	HONGLITRONIC	40	LPR	83
CARCLO	15	OPSIRA	41	CREE	84
FUHUA	16	REFOND	47		
BARTHELME	17	AUER LIGHTING	52		

IMMEDIATE SHIPMENT FROM THE WORLD'S LARGEST SELECTION OF ELECTRONIC COMPONENTS™



**OPEN
ACCOUNTS
AVAILABLE**
FOR QUALIFYING
CUSTOMERS



**FREE
SHIPPING
ON ORDERS
OVER €65***



**LOCAL
SALES &
TECHNICAL
SUPPORT**



Free Online Tool
Access the **BOM Manager** now!
DIGIKEY.COM/BOMMANAGER



FIND CONTACT AND ORDERING
INFORMATION FOR YOUR REGION AT
DIGIKEY.COM/EUROPE

1,200,000+ PRODUCTS IN STOCK | 650+ INDUSTRY-LEADING SUPPLIERS | 4.6 MILLION PARTS ONLINE

*A shipping charge of €18.00 (£12.00) will be billed on all orders of less than €65.00 (£50.00). All orders are shipped via UPS for delivery within 1-3 days (dependent on final destination). No handling fees. All prices are in euro and British pound sterling. If excessive weight or unique circumstances require deviation from this charge, customers will be contacted prior to shipping order. Digi-Key is an authorized distributor for all supplier partners. New product added daily. © 2015 Digi-Key Electronics, 701 Brooks Ave. South, Thief River Falls, MN 56701, USA



Heinz Seyringer

Heinz Seyringer studied physics and mathematics at the Swiss Federal Institute of Technology in Zurich (ETH) with a specialization on quantum electronics and got a PhD in semiconductor physics. In 2000 he was one of the founding members of Photeon Technologies where he was also general manager until he joined the Zumtobel Group in 2009 where he is responsible for the research collaborations. He is also on the European Photonics Industry Consortium (EPIC) board of directors, on the board of stakeholders at Photonics21, on the steering committee of the Smartlighting Conference and chairman of Photonics Austria.

LIGHTING BEYOND ILLUMINATION

Currently, lighting is at the same point the mobile phones were when the first additional features beyond the actual phone service were introduced. There are many new possibilities arising but nobody knows which of them will be the killer apps of tomorrow. When the first cameras were added to mobile phones, nobody would have assumed that there would come a day when more pictures were taken with mobile phones than with actual cameras or when the text-messaging service was introduced, probably nobody would have assumed that the text message-based service Twitter would become so successful.

In lighting we are now just introducing the basis for such additional services. There are technologies which most people know by now or have at least heard about, like human centric lighting, which is using light to improve the performance and well-being of people. But while in the beginning the implementation was very rudimentary (cold white for activating and warm white for calming down) it has now been discovered that light can directly influence our hormones via the retinal ganglion cells in the eye and if we go beyond the visible spectrum we could improve vitamin D production which would give significant health benefits especially in the winter because that is when we don't get enough UV-light from the sun to keep our vitamin D production at the required levels.

With semantic lighting, light could project information on the tables or walls and floors around you to let you know how to fold a map or make a cup of tea with the ideal temperature and brewing time. Or in combination with the appropriate sensors, the lighting could let you know that the plate of soup in front of you is still too hot to eat by projecting a warning sign directly on the surface of your soup

and letting you know as soon as the soup is cold enough to eat.

While the global positioning system doesn't work indoors, with the proper technology, luminaires could take over the role of the satellites and allow for an indoor positioning system. This could allow you to find your next meeting room easily, the products in the supermarket or send you the relevant discounts if you are near a certain product group in the supermarket. Furthermore, light has the potential to be used as a medium for communication in many other aspects with the advantage of having a potentially much higher transmission capacity than classical WLAN (in fact the internet wouldn't be possible anymore without the high transmission capacities of the fiber optic backbone).

Also, on the interface side there would be a lot of new possibilities: besides the classic light switches and touch screens for controlling the lighting, there might be voice interfaces that you know from cars and mobile assistants like "OK Google" or Siri. Another alternative could be gesture control allowing you to point at the areas you would like to have illuminated or swipe to change the intensity or color temperature of the lighting.

Most of these technologies have still their intrinsic problems ranging from technical problems up to acceptance problems by the user. And since it is hard to estimate which problems can be overcome and which will stay around, it is hard to estimate in which direction the new killer apps will go. However, if we take a look at the evolution of mobile phones, we can be pretty sure that in the not too distant future illumination will only be one of many features of a lighting system and probably not even the most important one anymore. ■

H.S.



Architectural Lighting
Commercial Lighting



★ waterproof design



LL01NI-BYKxxL19

DxH(mm) 16x8
FWHM 20° 30° 40° 60° 25x45°
CREE XPE2 / XPG2 / XTE
Lumileds Luxeon Z / Z ES
NICHIA NF2x757D / NVS19B / NCS19B



LL01CR-BJL40L02

DxH(mm)35x12.55
FWHM 40°
CREE CXA13xx
Citizen CLL010
Lumileds L2C1-1202
Seoul ZC4/ZC6



Street Lighting



LL04CR-BXJxxL02

LxWxH(mm) 50x50x7.3
FWHM 60° 90° 45°x155° 80°x150°
Cree XPE2/ XPG2/ XPL
Lumileds Luxeon T
BXJ60/90: Type V
BXJ45155: Type II-S
BXJ80150-Type III-S



LL04CR-CFNxxL02

LxWxH(mm) 50x50x7.3
FWHM 35°x155° 65°x155°
Cree XPL
Lumileds Luxeon T
CFN35155-Type II-M
CFN65155-Type III-M



LL04CR-CGM85135L02

LxWxH(mm) 50x50x7
FWHM 85°x135°
Cree XPE2/ XPG2/ XPL
Type I-S

Ultra-Thin Hybrid Lens

- ★ Thinning lens use Fresnel design.
- ★ Compatible with most COB LED.



LL01ZZ-CPRxxL46

DxH(mm) 47x8.5
FWHM 24° 38°
CREE CXA13xx/ MHB
Citizen CLL010
Seoul ZC4/ZC6



LL01ZZ-CPQxxL46

DxH(mm)74.4x13
FWHM 24° 38°
CREE MHD/CXA15xx
Citizen CLL020
Seoul ZC12/ZC18



LL01CR-CEWxxL02

DxH(mm)50x15
FWHM 12° 24° 38°
CREE CXA 13xx/15xx
Citizen CLL020/CLU700
Sharp Mini Zenigata
Xicato XTM-9mmLES
Connector:LL01A00CZNB2-M2
(For:CREE CXA13xx)



LL01CR-CENxxL02

DxH(mm)70x17.5
FWHM 12° 24° 38°
CREE CXA 15xx
Citizen CLL020/CLL030
Sharp Mini/ Mega Zenigata
Xicato XTM-9 / 19mmLES
Connector:LL01A00CZMB2-M2
(For:CREE CXA15xx)



LL01CR-CHQxxL02

DxH(mm) 35x10.5
FWHM 24° 38°
CREE CXA 13xx/ MKR2
Lumileds L2C1-1202
Connector:LL01A00CZNB2-M2
(For:CREE CXA13xx)



LL01CR-CEOxxL02

DxH(mm)90x19.5
FWHM 12° 24° 38°
CREE CXA 15xx/18xx/25xx
Citizen CLL030
Sharp Mega Zenigata
Xicato XTM-9 / 19mmLES

Osram Adds Filament LEDs to Its Product Portfolio

LED filaments instead of tungsten wire. Osram Opto Semiconductors presents the Soleriq L 38, the first filament LED in its product range. The long thin shape of the LEDs provides the basis for filament lamps which, in terms of their appearance and their emission characteristics, are more than a match for their incandescent lamp predecessors. The Soleriq LEDs offer an extremely uniform color appearance and quality of light, creating a pleasant atmosphere. They are therefore ideal for aesthetic lighting applications in the home and in hotels and restaurants.



The new Osram Soleriq L 38 is ideal for use in products with a traditional look

Technical data:

- Package: 30 mm x 1.8 mm (diameter)
- Brightness: 90 lm / 130 lm / 140 lm
- Forward voltage 90 lm: 56 – 64 V
- 130 lm: 82 – 90 V
- 140 lm: 88 – 96 V
- Color temperature: 2500 – 4000 K
- Color rendering index (CRI): >80

Each Soleriq L 38 has a length of 30 mm and a diameter of 1.8 mm. This shape, which is similar to that of a conventional filament, plus an emission angle of 360 degrees and their excellent quality of light make them perfect for use in LED lamps of all wattages that mimic the appearance of classic light bulbs. Soleriq L 38 LEDs are offered in different MacAdam groups according to their color, forward voltage and brightness – at a temperature of 85°C which closely approximates to the temperature in the application. Filament LEDs therefore have an extremely uniform color appearance and quality of light.

“Customers will benefit from these properties, particularly if they want to install multiple lamps or luminaires fitted with

Soleriq L 38 in a room”, said Product Manager Wong Kum Yih of Osram Opto Semiconductors. “Incorporating the LEDs in classic lamp production lines is very simple because with only minor modifications to the manufacturing process they can be installed in the lamp in the same way as traditional filaments.” Sorting by forward voltage enables multiple LED filaments to be connected in parallel, resulting in reliable operation with no overloading of individual filaments.

Like all Soleriq products, the L 38 offers high brightness. It is available in three versions with 90, 130 or 140 lumen (lm). These values enable all previous lamp wattages up to 60 W to be replaced with equivalent LED filament solutions. The driver voltage needed for the LED filament lamps can also be adjusted. All the versions have an extremely high luminous efficacy of 150 lm/W and provide warm white light (2500 to 4000 K). Thanks to the good color rendering index of over 80, the new Soleriq is ideal for indoor lighting, particularly in the home. The main applications include products with a traditional look and modern interior, such as classic glass bulbs with LED filaments. ■

Xicato Expands Options for Its Intelligent LED Module Range

Xicato, a leading manufacturer of intelligent light sources, has established new benchmarks for dimming, flicker, color consistency and lumen maintenance with the release of its XIM Intelligent LED Modules. The company has announced the availability of higher lumen packages to fill out the portfolio, a 9mm LES option in addition to the current 19mm LES option, and a true and verifiable 50,000 hour warranty.



Following the introduction of the XTM 9mm, Xicato announced their intelligent XICATO XIM version with 9mm LES

The XIM module delivers smooth, deep dimming to 0.1% and meets IEEE 1789 standards, eliminating negative health effects related to flicker. Good dimming consists of many important elements, including smoothness, predictable response to input and a broad adjustable range and consistency between all sources. “By integrating the dimming engine into the LED module, we have been able to set new standards. XIM modules dim harmoniously and gracefully, adding a well-executed choreographic element to the lighting design,” says Willem Sillevs Smitt, Vice President of Marketing at Xicato.

Xicato is the first to equip its Intelligent Modules with sensors that register vital operating parameters that get stored in the on-board microprocessor. This allows for temperature feedback control to prevent overheating in the case of unforeseen conditions or erroneous installation. By also registering operating time, warranty can now be tied to true operating hours, removing the need to guess based on operating days and hours per day. Xicato warrants its XIM products for 50,000 hours (or 7 years, whichever comes first), covering light output and color consistency as well as the integrated electronics at zero failures. Xicato’s approach to warranty provides substantial improvements to fixture dependability and sustainability, lowering total cost of ownership at the same time.

Driven off a 48 V DC external power supply, Xicato Intelligent Modules enable a simpler light fixture design that is easier to scale and is future proof to ongoing LED improvements and module enhancements. Fixtures can now be qualified to UL2108, significantly easing fixture design and shortening development time and cost in relevant markets. Because the LED driver is no longer necessary inside the fixture, smaller and more elegant designs are possible.

“Xicato Intelligent Modules deliver improved control performance and are easy and cost effective to implement at the same time. We see customers implementing better designed fixtures, delighting end-users in retail, museums and restaurants with less obtrusive lighting systems,” says Rob Verbeelen, CEO of Luxendi, Xicato distributor in Belgium, The Netherlands and France. “These benefits, coupled with Xicato’s unmatched color consistency and reliability, ensure beautiful spaces for years to come.” ■

Luminus Announces New High Efficacy 3 V 3030 Mid-Power LEDs

Luminus, Inc., a global manufacturer of high-performance LEDs, announced today a new family of 3 volt 3030 midpower LEDs offering a wide range of options including 200 lumens per Watt, 95+ CRI, and “candle-warm” 2200 K. Luminus has been building a reputation as the market leader in high quality-of-light with their chip-on-board (COB) arrays and mid-power products, and this new MP-3030-1100 series contributes further to that effort. There are a total of 18 different CCT/CRI combinations to choose from in this family, including cool white 70 CRI products capable of delivering up to 200 lumens per watt in outdoor applications and AccuWhite™ 95 CRI minimum (97 typical) warm white for luxury retail applications.

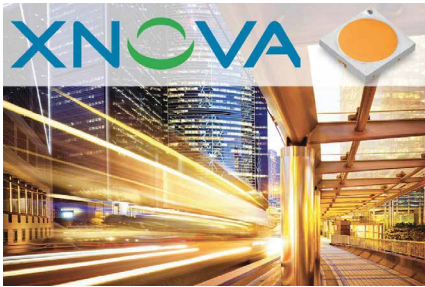

Luminus' new XNOVA 3 Volt 3030 Mid-Power LEDs delivers up to 200 lumens per Watt, and is available with 97 CRI or 2200 K candle-warm options

Mark Pugh, VP of Marketing at Luminus, notes, “Our customers have recognized the leading performance, breadth of product, and outstanding quality of light delivered by our COB arrays and big chip LEDs in directional applications, and now they are thrilled to have the same characteristics in a midpower product to enable a complete line of non-directional luminaires which satisfy even the most demanding specifiers and end users.”

Another feature of the Luminus MP-3030-1100 family is “hot color targeting”, which means that the LEDs are engineered to produce light with chromaticity tightly centered in the ANSI bin under normal operating conditions of 85°C. In contrast, competitors' LEDs which are usually color targeted at 25°C tend to drift away from the ANSI bin in the field, where operating temperatures are much higher. Luminus 3030 LEDs are tested at 150 mA

nominal forward current and can be driven as hard as 240 mA to provide optimal lumens per dollar. The 5700 K, 70 CRI product delivers as many as 200 lumens per watt at 65 mA for those customers who want to maximize system efficacy. ■

Lumileds Luxeon CoB 1216 for Improved Streetlight Efficiency

Designers of high lumen streetlights, high bay fixtures and downlights are taking advantage of Lumileds latest addition to its successful Luxeon CoB Core Range portfolio, the Luxeon CoB 1216. These arrays provide a 40% greater flux than Lumileds existing CoBs in an identical mechanical footprint.



The Luxeon CoB 1216 achieves up to 15,000 lumens in an industry standard package, allowing designers of streetlights and high bay luminaires to drive down fixture cost

“We continue to push our chip-on-board technology to higher efficiency, which is important in all applications but particularly in outdoor fixtures,” said Eric Senders, Product Line Director for CoB LEDs at Lumileds. “With the new line of arrays, customers are achieving 150 lm/W at nominal condition, which, combined with our lowest in the industry thermal resistance, leads to the most cost efficient systems.”

In addition to high lumen output and efficiency, the Luxeon CoB 1216 provides the beam uniformity and ease of design required for streetlights and high bay fixtures, allowing replacement of 100-150 W HIDs. Featuring a 23 mm light emitting surface (LES) in a standard 28 x 28 mm package, the Luxeon CoB 1216 can take advantage of the wide variety of optics and compatible holders in this size, allowing fixture manufacturers

We bring quality to light.



Putting LEDs in the right light

SSL solutions from the world leader in LED measurement

Right from the start, we have been supporting the LED industries with our measurement equipment. You will also benefit from this expertise in the new Solid-State Lighting applications. Our solutions combine highly precise spectroradiometers and photometers with a complete family of goniometers and integrating spheres.

Discover light with Instrument Systems!



Instrument Systems
light measurement

www.instrumentsystems.com
www.instrumentsystems.com/ssl

to speed time to market of their luminaires. "We are hearing very positive feedback from the several leading lighting companies who have already adopted the Luxeon CoB 1216, and we see this product will become a great success," said Senders.

The Luxeon CoB 1216 is offered in the industry's widest range of color temperatures (2200 K to 5700 K) and CRIs (70, 80 and 90). 100% of Luxeon CoB Core Range (Gen 2) arrays are hot tested at 85°C to ensure performance in real world operating conditions and to minimize additional testing. A low thermal resistance substrate minimizes heat sink needs. ■

New Highest Flux Density RGBW Emitters from LED Engin

LED Engin, Inc. announces a new world record in both flux and power density for high power, multi-color LED lighting with its latest LZP family of red, green, blue and cool white (RGBW) emitters. The 25-die, 80-watt emitters deliver 3800 lumens, the world's highest luminous flux density from a 6.2 x 6.2mm light emitting area on 12 x 12mm emitter footprint. This has been achieved through an improved LZP package design that results in the industry's lowest thermal resistance per package footprint of 0.5 °C/watt. As a result, the LZP now gives designers of entertainment and architectural lighting the freedom to create more powerful yet slimmer, very compact lamps in innovative new styles that appeal to customers. The emitter is the first of three new multi-color products in LED Engin's development schedule announced in April. The others are the LZ7 7-color emitter and the ultra-high power LZ4 4-die RGBW, which can be driven up to 3 amps/die.



Enhanced LZP 80 watt emitters set a new power density record from a tiny 12mm x 12 mm footprint to help designers create beautiful, efficient lighting

The LZP series is available in two versions, featuring either a domed or flat glass primary lens for different applications. The LZP-00MD00 with its glass dome lens is typically used with a total internal reflection (TIR) secondary lens to deliver high flux output. It's a popular choice for architectural lighting, including wall-wash fixtures and accent and effect lighting. The flat lens of the LZP-04MD00 is particularly suited to punchy stage and studio lighting where beams of less than 10 degrees are often required. Its compact étendue facilitates the use of zoom optics, mixing rods, light pipes or other optics to produce narrow beams.

Using only three of the new LZP emitters, illumination equivalent to that from a typical 10,000 lm (approximately 700 watt) HID bulb used in profile lamps can be achieved. Light absorbing color filters are not needed, so efficiency is greatly improved. With 25 mixed-color dies arranged closely, the LZP series simplifies board and circuit design. It also enables a more compact fixture footprint than that of competing single-die or 4-die LEDs. What's more, fewer secondary optical components are required, helping reduce the bill of materials and simplifying attachment of the optics.

LED Engin offers a full suite of total internal reflection (TIR) optics suitable for use with the LZP emitters, offering a wide range of output patterns from 13 to 47 degrees, which help designers create high-performing and unique solutions to lighting challenges. Zoom optics and optics for beams narrower than 10 degrees are available from a third-party supplier in December.

David Tahmassebi, LED Engin's CEO and President, said, "These new emitters once again demonstrate LED Engin's technical innovation and leadership. We're dedicated to developing LED products that enable lighting designers to express their creativity and produce better products for their customers, particularly in the competitive and highly demanding entertainment lighting sector."

The LZP-00MD00 and LZP-04MD00 are available now from LED Engin and its distributors. The company is also sampling the LZ7 and ultra-high power LZ4 RGBW. Further details of these products will be released when they are available in volume. ■

LG Innotek - High Power LED Packages with Best Efficacy

LG Innotek, a leading global materials and components manufacturer, announced that the company is starting to produce high-power LED packages (H35C4 Series) featuring 180 lm/W, which are the highest efficacy in the world. LG Innotek improves the efficacy of high-power LED packages by 13% compared to the previous packages. It is also superior to competitor's product in efficacy by 10%.



LG Innotek claims its H35C4 Series to beat competing products' efficiency under identical conditions by over 10 lm/W

LG Innotek used its proprietary vertical LED chip technology to optimize the manufacturing and mixing process of the fluorescent substance that produces the light for its LED chips, thus improving the performance of their LED packages. This performance is at least 10% better than all other competing products.

These LED packages boast an efficacy of 152 lm/W at 85°C, 700 mA under the actual usage environment of most LED packages. It beats the efficacy of competing products by 10 lm/W or more.

Through optimizing "white conversion technology", the lifespan of the product has also increased greatly. According to the expected lifespan based on LM-80, the LED lighting reliability evaluation criteria used by the US Environmental Protection Agency (EPA), the average lifespan of LG Innotek's product is 150,000 hours. This is almost three times longer than existing products, which have a lifespan of 51,000 hours.

In addition, LG Innotek has established a product line-up that encompasses all ranges of color temperatures and rendering, including warm white (2700 K), neutral white (5000 K), cool daylight (6500 K), and High CRI (CRI>90). Customers can apply these products for their use in LED lighting.

LG Innotek will stay focused on developing high performance and value product such as High Power LED Package featuring more than 5 watt and UV LED. The Company also has a plan to enhance its LED lighting line-up for automotive as well mobile application. ■

New Osram Ostar Stage - Twice the Brightness from the Same Chip Size

Osram Opto Semiconductors has expanded the product portfolio of its Osram Ostar Stage family. The four chips of the new high-power LED in red, green, blue and white can be operated at up to 2.5 ampere (DC) thanks to improved chip technologies. This leads to twice the output of 30 watts (electric) from the same chip and package area compared to the existing version, adding another output class to the product family. The new LEDs were developed primarily for use in stage spotlights.

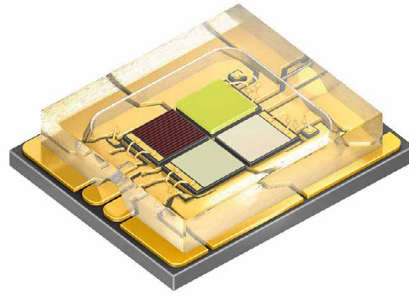

The thinfilm and UX:3 chips of the Osram Ostar Stage can be operated at up to 2.5 A, resulting in a higher output

Technical data (LE RTDUW S2WN):

- Dimensions: 4.68 x 5.75 x 1.26 mm
- Chip size: 1 mm²
- Thermal resistance Rth: 0.9 K/W
- Output: 30 W
- Beam angle: 120°

Four high-power chips with the latest thin film and UX:3 technology in red, green, blue and white are the basis of the improved brightness of the new Osram Ostar Stage. The 1 mm² chips can be operated for the first time at up to 2.5 ampere (A) providing

an output of 30 watts (W), which is twice as high as the existing version. The Osram Ostar Stage versions now cover outputs between 15 and 60 watts. "The higher current that is necessary for a higher output requires the thermal management of the Osram Ostar Stage to be adapted so that the heat generated in the chip can be removed as effectively as possible", said Wolfgang Schnabel, Product Marketing LED Industry at Osram Opto Semiconductors.

More flexibility with a number of identical parameters:

"At the same time many features such as the package size and beam characteristics match the ones from previous versions. That way customers can stick to their existing optics, and the overall design of their lighting solutions", added Schnabel. The new Osram Ostar Stage gives customers more flexibility for their stage spotlight product portfolio. Spotlights with the same number of LEDs will be even more powerful, and spotlights with fewer light emitting diodes will have the same brightness.



[ZENIGATA COB]



[LED]



[INTERMO MODULES]

Sharp ZENIGATA COB LEDs raise the bar for quality LED lighting that's now even easier to design with Sharp's integrated INTERMO modules. In addition to a broad range of fixed white LEDs, Sharp also supplies the tuneable white Tiger ZENIGATA

(2,700K–5,700K). From tailored white LEDs for grocery stores and shops to natural toning LEDs that warm as they dim, Sharp's LED technology platform excels in office, home, commercial, and outdoor lighting. E-mail us for details: sharpse@sharp.eu

Apart from stage lighting, the new Osram Ostar Stage LEDs are ideal for use in mood and architectural lighting; in the latter case, they are the preferred light source for effect and accent lighting. The high-power LEDs will be available from Q1/2016 in volumes. ■

Lumileds Strengthens CSP Leadership with New FlipChip Line

Lumileds extends its CSP leadership, announcing Luxeon FlipChip White. Spearheading the adoption of CSP in LEDs, Lumileds has shipped over 500 million LED emitters to date across several applications. The company first introduced Luxeon FlipChip Royal Blue in February 2013, giving luminaire manufacturers complete design flexibility by starting with the LED die. ■

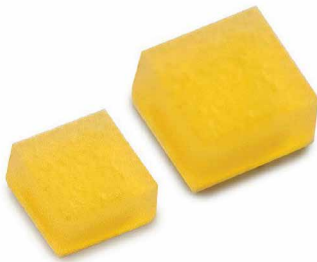

Lumileds continues to push the technology envelope with its family of Chip Scale Package (CSP) LEDs. Luxeon FlipChip White brings industry leading lumen density and lm/\$ to illumination applications

CSP technology eliminates the traditional submount to minimize package size, thus enabling manufacturers to directly attach the LED die to the PCB, allowing for overall system cost reductions. Lumileds CSP technology is optimized to deliver high efficacy at high current density, achieving industry-leading lumen density and lm/\$.

High lumen applications such as outdoor and industrial lighting benefit from the high drive current capabilities and robust high power architecture of Luxeon FlipChip White. In addition, the small source size and high lumen density of Luxeon FlipChip White enables high packing density and superior beam control for directional lamps and luminaires. Luxeon FlipChip White is offered in two package sizes (1.4 x 1.4 mm and 1.1 x 1.1 mm) and a range of CCTs across 70 and 80 CRI. ■

Lumileds further accelerates the industry's adoption of CSP Technology by offering Luxeon FlipChip White on its market-leading Matrix Platform. These LED boards, linear flex and modules can come configured with Luxeon FlipChip White along with connectors, optics, wiring and/or electronics, improving time-to-market and simplifying the supply chain. ■

Cree's High Intensity Color LEDs for Highest Candela Performance

Cree introduces XLamp® XQ-E High Intensity LEDs, the industry's first family of color LEDs optimized for optical performance. This drop-in upgrade for proven XQ-E High Density designs enables lighting manufacturers to double the candela performance with minimal redesign. ■

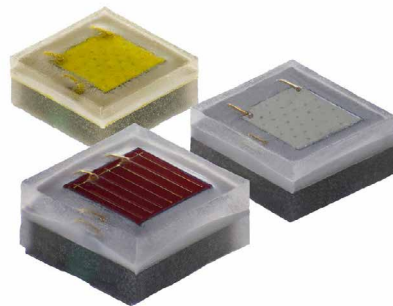

Visitors and attendees of the LpS 2015 were the first to be introduced to the new XQ-E High Intensity LEDs and to get to know the specifications

The new High Intensity LEDs leverage XQ-E's proven optical symmetry and consistency across all colors to improve color mixing and simplify the production process for lighting manufacturers. Built on Cree's breakthrough SC5 Technology™ Platform, the XQ-E High Intensity LED is the smallest building block available for color LED designs allowing lighting manufacturers to quickly boost performance and drastically reduce size for directional applications such as track and architectural lighting. ■

"Cree continues to drive innovation within the solid state lighting market by truly listening to the customer and providing solutions like the XQ-E High Intensity LED. At Lumenpulse, candela is the name of the game, and we want to put as much light as possible on the surface we are illuminating, as efficiently as possible," said Greg Campbell, Senior Vice President and Chief Technology Officer at

Lumenpulse. "The XQ-E High Intensity is a perfect tool in our toolkit to maximize candela output for our innovative products." ■

Available in white, red, red-orange, PC amber, green, blue and royal blue, the XQ-E High Intensity LED features Cree's innovative new primary optic design that radically reduces optical source size by more than 50 percent to deliver the industry's best optical control. ■

"We are excited that Cree is extending its high intensity class of performance to the XQ family," said Antonio Di Gangi, CEO, DGA. "The combination of high lumen output, innovative primary optic and the tiny footprint of the XQ-E High Intensity LEDs enables us to create compact luminaires that deliver a lot of punch." ■

The XQ-E High Intensity White is available in color temperatures ranging from 2700 K to 6200 K and CRI options of 70, 80 and 90. Product samples are available now and production quantities are available with standard lead times. ■

Osram Black Flat S for Automotive Provides up to 2000 Lumen

Osram Opto Semiconductors is unveiling an LED prototype in surface mount technology (SMT) with a brightness of up to 2000 lumen (lm) at ISAL 2015 – the Osram Black Flat S. Experts achieved this high output by combining five chips from the latest UX:3 generation with an improved SMT package. A single LED is therefore sufficient as the light source for combined low-beam and high-beam systems. The excellent thermal connection with the package allows for passive cooling, which reduces system costs. ■

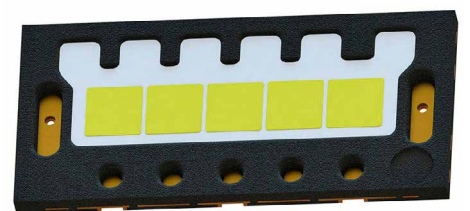

The five chips of the Osram Black Flat S can be driven individually and are ideal for adaptive front lighting systems

The Oslon Black Flat S is consequently a viable alternative to HID (High Intensity Discharge) lamps and is scheduled to be added to the Osram automotive portfolio at the end of 2016.

Osram Opto Semiconductors is showcasing the new SMT prototype Oslon Black Flat S with five high-current chips at ISAL 2015 (International Symposium on Automotive Lighting). In terms of increasing output, this is a logical development of existing versions of the automotive product family and shows that high luminous flux values of up to 2000 lumen (lm) are possible from a single light emitting diode (LED). At the same time, the SMT component has a footprint of 3.75 mm x 7.9 mm, which is only slightly larger than that of the previous 5-chip version.

Improved heat distribution – essential in view of the high currents involved – provides the basis for the high brightness. This brightness comes from five high-current chips based on latest-generation UX:3 technology, together with an improved package. The thermal

connection has been greatly improved by larger contact pads, which means that the headlights can benefit from passive cooling. This in turn reduces system costs considerably and makes the LED solution a viable alternative for vehicles that are now equipped with HID lamps. At a current of 1 ampere (A), a power loss of 12 watt (W) and an ambient temperature of 25°C, the temperature at the chip is only 69°C, which means that the temperature difference compared with the predecessor version has been reduced from 58°C to 44°C. The prototype LED is operated at a current of 2 A and a voltage of 15.5 V. The optical output is 6.5 W.

“The five chips of the Oslon Black Flat S can also be driven individually”, said Stefan Grötsch, Senior Key Expert Automotive Application Engineering at Osram Opto Semiconductors. “The future LED version will therefore be ideal for adaptive front lighting systems.” ■

Samsung's COB LED Packages with Superior Color Quality

Samsung's new chip-on-board (COB) LED package lineups with industry-leading color quality include small LES (light-emitting surface) COB packages, high CRI (color rendering index) COBs, and vivid COBs. The new COB packages, with their outstanding color quality and scaled-down light-emitting space requirements, will provide a major design alternative for LED lighting makers.



Samsung's new COB LED line-ups include small LES, high CRI, and vivid COBs

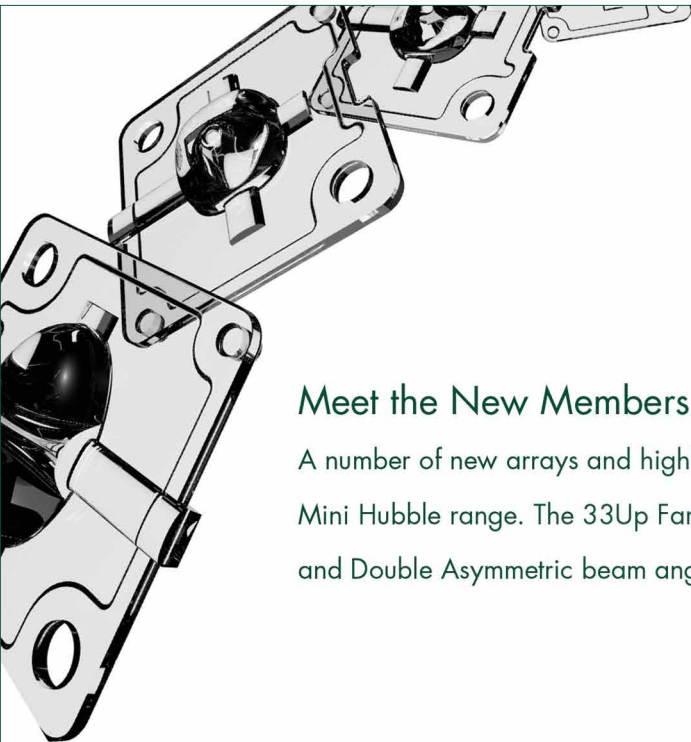

Meet the New Members of the Family...

A number of new arrays and highbay versions have been added to the Mini Hubble range. The 33Up Family has been extended to include 60° and Double Asymmetric beam angles.

Come and visit us...

Stand C1



18-19 November 2015 | ExCeL London

carclo-optics.com

sales@carclo-optics.com

Optic
Select

carclo
Optics

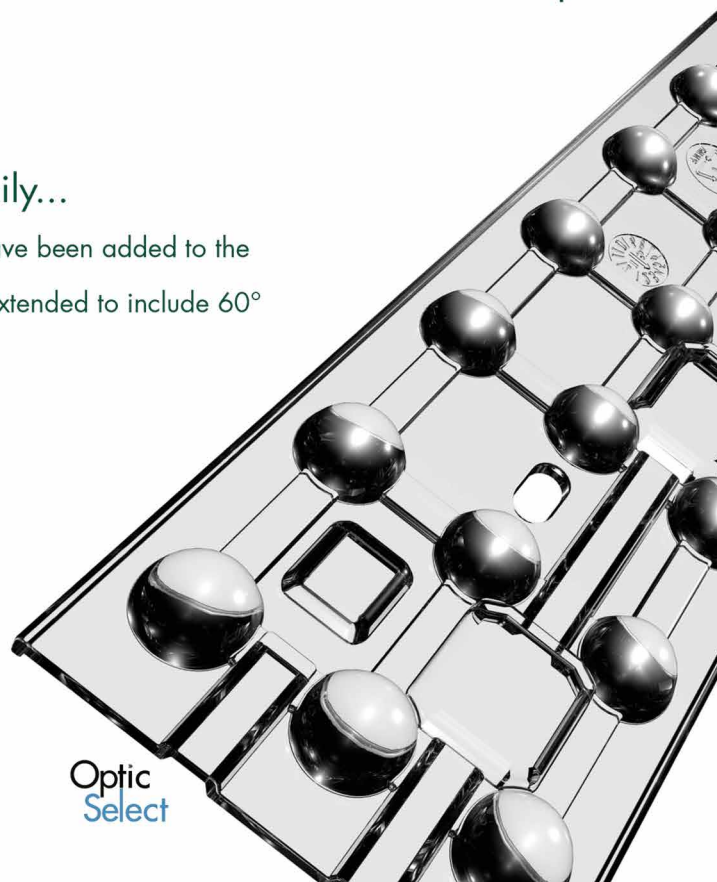



UE Electronic
Since 1989

320W outdoor LED driver
(UEL320-A1Z)
24-48V DC 6.66-8.88A

36W indoor LED driver
(UE36LCP-SPA)
9-24V DC 0.1-3A
UL, TUV, CE, CCC, CB

PSB BSMI SABS WEEE ISO 14001:2004
ISO 9001:2008 CEC OHSAS 18001:2007

CB CCC CQC CUL US CNS US FC
CE JET TUV GS ENCCC

Fuhua Electronic Co., Ltd
Fuhua Electronic Industrial Park, Xianglong Rd.,
Huangzhou New Town, Shilong, Dongguan,
Guangdong, China
Tel: (86) 769-8602 2222 Fax: (86) 769-8602 3333
www.fuhua-cn.com E-mail: fuhua@fuhua-cn.com

“By expanding our COB package lineup, we are providing greater value to the LED lighting market, while giving our customers much more design flexibility with which to address market needs,” said Jacob Tarn, Executive Vice President, LED Lighting Business Team, Samsung Electronics. “Samsung is continuing to introduce well-differentiated LED components to meet our customers’ needs, while strengthening our presence in the LED marketplace.”

Small LES COB LED Packages:

Samsung LED’s new Small LES COB packages – LC010C, LC020C and LC040C – offer 10 W, 20 W and 40 W of operating wattage options respectively and significantly reduced LES. For the 40W-class LC040C, the diameter of Samsung’s LES has shrunk to 11mm from the 17 mm typically specified in conventional 40 W COB packages. For the LC010C and LC020C offerings, the LES scaled to 6 mm from 11 mm and to 8 mm from 12.4 mm, respectively. These LES packages are approximately 35 percent smaller than the LES in most existing COB packages available today.

Moreover, they offer exceptionally high light intensity and even higher Center Beam Candle Power (CBCP) to provide the optimal narrow-beam solution for spotlights.

In addition, Samsung LED’s new Small LES COB packages are built with advanced flip chip technology that enables them to deliver high reliability with low droop, under high current and high thermal conditions. The new Small LES COB lineup features high-efficacy levels of 110 lm/W at 3000 K CCT, CRI 80+, 85°C.

COB LED Packages with Ultra-high Color Rendering:

Samsung’s newly introduced COB LED packages offer high color-rendering with a CRI value of over 95. The high color rendering packages faithfully reveal the true colors of various objects with excellent color index distribution, and are used mainly for commercial LED lighting, which needs to present the color of goods in their most natural state. The high-color-quality COB packages support CCT (Correlated Color Temperature) specifications between 2700 K and 3500K. Samsung’s ultra-high-CRI lineup is now available.

Vivid COB Packages:

Samsung’s new Vivid COB packages feature much more brilliant colors than virtually any commercial LED light, making objects appear as attractive as possible to the human eye. This feature is based on the Vivid COB packages’ color spectrum tuning and phosphor controlling. As a result, the package helps depict objects much more clearly with intense levels of color saturation.

Moreover, Samsung now provides worldwide certification support to LED lighting component customers. Since January, Samsung has established cooperative relationships with certification companies such as Intertek, Korea Testing Laboratory (KTL), TÜV SÜD and China Certification & Inspection Group Korea (CCIC KOREA) for the US, Korean, European, and Chinese markets, respectively. These partnerships will help to minimize any difficulties that customers could encounter with varying regional certification requirements for lighting quality, safety and power efficiency, as well as simplify complex procedures, reduce time-to-market and ultimately have a positive impact on overall cost. ■

Toshiba to Expand Range of GaN-on-Si High Power White LEDs

Toshiba Electronics Europe has added four new products to its TL1L4 series of white LEDs. These new additions provide a high luminous flux and are suited to applications ranging from street and stadium lighting to LED light bulbs and down lighting for use in the home.



Toshiba’s new LEDs provide high luminous flux and lower power consumption for domestic and public applications

Like the existing members of the TL1L4 series, GaN-on-Si technology has been utilized to create LEDs optimized for both output and energy efficiency. However, the new 4A5B type improves upon these existing products by providing a min. luminous flux of 140 lm, compared to 130 lm. The new products make it possible to meet the market demands for improved lighting fixture efficacy by achieving efficacies of over 110 lm/W. The LEDs can also contribute to reducing the power consumed by LED lighting.

Measuring 3.5 x 3.5 mm, with a lens-top, the new LEDs offer different CCTs, with the TL1L4-DW0 providing 6500 K, the TL1L4-NT0 providing 5700 K, the TL1L4-NW0 5000 K and the TL1L4-WH0 4000 K. All offer a CRI of Ra >70 min. and a typ. forward voltage of 2.8 V. ■

Lumileds Introduces Luxeon XF-3014 CV Flexible LED Strips

Lumileds introduces the third member of the Matrix Platform family of integrated LED products, the Luxeon XF-3014 CV flexible LED strips. These 24V constant voltage LED strips distribute extremely uniform light across user-selectable lengths and require only a simple 24 V constant voltage driver.



Lumileds' Luxeon XF-3014 CV Flexible LED Strips provide long lengths of perfectly uniform light with unmatched flux uniformity

Applications such as edge-lit lights, downlights, cove lighting and accent lighting benefit from the LED strips' outstanding flux uniformity and color uniformity. The Luxeon XF-3014 CV strips are the industry's first LED strips to achieve 2% light output attenuation over a 10 meter strip. "Our unmatched flux uniformity eliminates the possibility of spottiness or color variation from strip to strip and over long lengths," said Andrew Cohen, Product Manager of the Matrix Platform family.

The Luxeon XF-3014 CV line of flexible LED strips provides 1000 lumens per meter and is offered as cuttable segments or with snap-in connectors. Specified at 2700 K, 3000 K, and 4000 K color temperature and a minimum CRI of 80, the strips are offered in three configurations for design flexibility using.

Luxeon XF-3014 CV Configurations:

- 6 LEDs per segments cuttable every 96 mm
- 6 LEDs, 96 mm segments with connectors
- 30 LED, 480 mm segments with connectors

Each 96 mm segment produces 112 lumens with 105 lm/W efficacy at 24 V (3000 K).

The Matrix Platform speeds time to market by offering turnkey solutions using proven, reliable Luxeon LEDs integrated with components and connectors on flexible or rigid substrates. The Lumileds Matrix Platform simplifies customer supply chains with its in-house capabilities and uses the most reliable and high quality assembly practices.

The Luxeon XF-3014 CV line addresses the need for long lengths of LED flexible

strips with uniform light output and simple 24 V driver supportability that can be easily mounted with a pressure sensitive adhesive.

The outstanding flux uniformity of the Luxeon XF-3014 Constant Voltage (CV) strips will appeal to designers of LED cove lighting, accent lighting, and other applications requiring long, flexible strips of uniform light. ■

Tridonic Tunable White - Feel-Good Light for Offices

Tridonic has expanded its product portfolio in the Tunable White segment with the addition of the square TALEXEngine QLE PREMIUM LED module which has been designed specifically for area luminaires in offices, educational establishments and healthcare facilities. People who spend many hours in artificial lighting will be the main beneficiaries.



Tridonic's Tunable White Area System consists of 4 tiles and delivers up to 5,000 lumens at a system efficiency of 130 lm/W

Natural daylight has a positive effect on our well-being, health and productivity. It helps alleviate mood swings and keeps our biorhythms in balance. Dynamically adjustable light that changes over the course of the day has a comparable effect. Tridonic offers a square lighting solution known as the Tunable White Area System which is tailored precisely to the area luminaires used in offices, educational establishments and healthcare facilities.

The Tunable White Area System is available as a pre-calibrated set that provides optimum quality of light and high colour consistency. It consists of four square LED modules each with a luminous flux of 1250 lm and one

B

AQUALUC® C:URVE MINI BRAVING ALL ELEMENTS

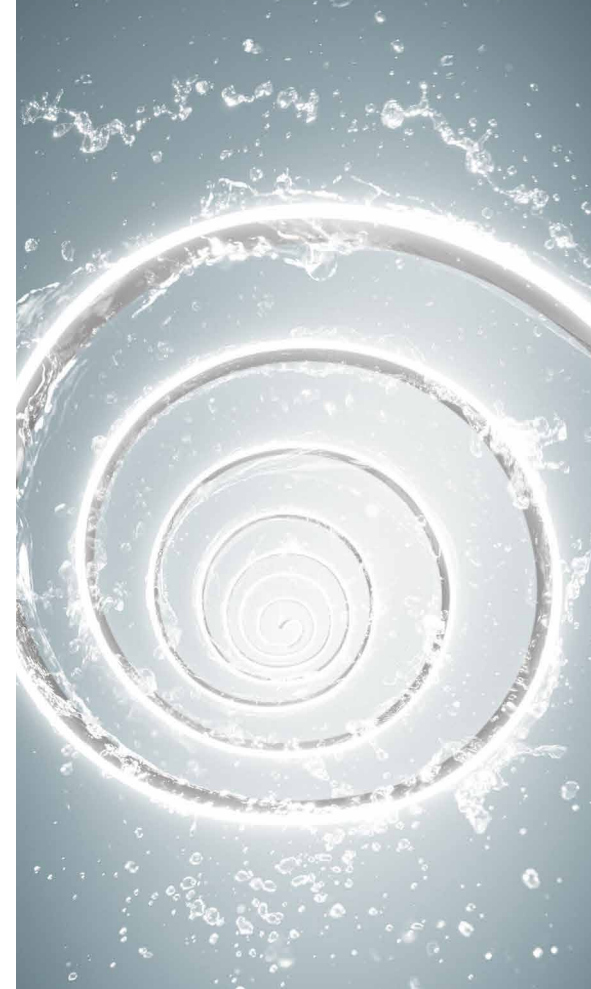

Flexible and absolutely homogeneous LED luminaire

6mm slim with a bending radius of only 5cm

Resistant against water, UV radiation, abrasion and chemicals (IP 67/68)

Optimised heat dissipation thanks to special coating

Barthelme

LED Solutions

www.barthelme.de

low-profile LED driver with a one4all interface (DALI Device Type 8, DSI, switchDIM, colorTEMPERATURE) and an output of 75 W. System efficiency is more than 130 lm/W. Thanks to the calibration the color temperature can be set dynamically between 3000 K and 6000 K, with the luminous flux being kept constant. In addition, the system can be dimmed from 100 to 10% without changing the color temperature. This means that it is able to achieve an excellent system color tolerance of MacAdam 3.

Integrated thermal management ensures that the system does not require separate cooling. The long life of 50,000 hours reduces maintenance requirements considerably. The economical LED light sources and the dimming function combine to provide a high level of lighting comfort and a reduction in energy consumption. ■

Luminit Announced a New Edge-Lit Uniformity Tape and a New Direction Turning Film

Luminit LLC, a privately held high technology company specializing in custom and standard holographic light shaping diffusers, adds Edge-Lit Uniformity Tape (EUT) to its unique lineup of Light Shaping Diffusers®. EUT is an inexpensive and effective solution for solving common problems associated with widely-spaced LEDs. The company also introduces a new Direction Turning Film (DTF) to its growing line of optical technologies and products.

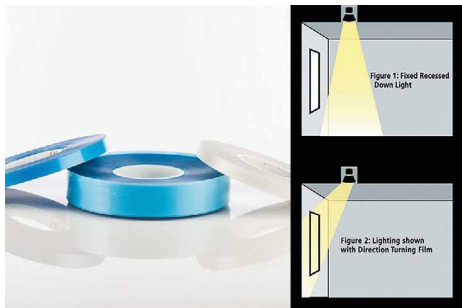

Luminit's new Edge-Lit Uniformity Tape (left) uses Luminit's patented diffusion technology, and the Direction Turning Film (right) enables 20° off-axis placement of an incoming beam

Edge-Lit Uniformity Tape:

EUT uses Luminit's patented diffusion technology that transforms and improves light for a brighter, more uniform panels. With a transmission greater than 88%, EUT allows

display and lighting manufacturers to achieve better uniformity and brighter displays and fixtures without increasing the number of LEDs.

"The more LEDs placed within a display, the better the uniformity will be," notes Suleyman Turgut, Director of Sales at Luminit, LLC. "The down side to this is an increase in the bill of materials. Our Edge-lit Uniformity Tape achieves better uniformity without increasing the number of LED lights which can result in significant cost savings for manufacturers."

Luminit's Edge-Lit Uniformity Tape uses an optically clear adhesive backing that can easily be applied directly to the side of the light guide plate during the assembly process. On the tape facing the light source are highly elliptical LSD microstructures that spread the light to reduce hot spots, dark spots and other non-uniform characteristics that can be visible on the edges of LED flat panel TVs and edge-lit lighting fixtures.

According to Luminit, optical characteristics of EUT include a transmission frequency greater than 88% and lighting panel uniformity greater than 80%. Light spread angle is +/- 70° from the normal. EUT is available in 50-meter rolls and widths ranging from 2.8 mm to 7.8 mm.

Direction Turning Film:

The unique light-bending film enables off-axis placement of an incoming beam to create an optimal angle for the viewer and provides a simple solution to lighting challenges. Allowing a 20° shift in the angle of a light source, Luminit Direction Turning Film offers lighting designers and engineers more flexibility on how and where a light beam is directed.

"Our Direction Turning Film solves a number of lighting and display challenges faced by engineers and designers," notes Suleyman Turgut, Director of Sales at Luminit. "DTF allows more beam control and can produce dramatic results particularly when used on downward recessed lighting to achieve more wall washing."

Ideal for LED light sources that utilize secondary optics, DTF includes microscopic, asymmetrical prismatic structures embedded on the film that change the light beam direction. DTF can redirect the light beam toward the wall, enhance lighting in pathways

and stairways, and redirect pool lighting for better, more uniform coverage. In addition to solving common problems associated with interior and exterior lighting structures, Luminit DTF can be incorporated into display panels such those used as in avionics to allow optimum views for both pilot and co-pilot.

Luminit DTFs are available as simple 20° direction turning films or can be combined with Light Luminit Light Shaping Diffuser® to homogenize, redirect, and increase the beam angle of a light source. ■

MarulaLED MA1077 IC Ensures Transformer Compatibility of LED Lamps

The MA1077 integrated circuit (IC) is for lighting manufacturers who dream of producing low-voltage (12 V) LED lamps that are broadly electronic transformer compatible. The MA1077 is based on MarulaLED's SlimDrive (Small Low-component-count Intelligent Multi-transformer) technology. Compared to other off-the-shelf ICs, the MA1077 has a number of differentiating features.



MarulaLED's MA1077 SlimDrive IC aims to simplify 12 V lamps design while maximizing transformer compatibility

Unlike other solutions in which the transformer-compatibility circuitry is tightly integrated with the driver circuitry, the MA1077 can be used in parallel to your existing LED driver circuitry. So instead of having to re-design your lamp with new transformer-compatible driver circuitry, you can use your existing driver circuitry together with the MA1077 IC.

The MA1077 uses only analogue circuitry, with no digital switching, so the IC has very low electromagnetic interference levels. The IC has very low power consumption, typically less than 0.25 W. It has a wide operation range from 0.2 W to 25 W.

The MA1077 solution is extremely compact, as few additional components need to be used with the IC. This allows for the production of very small form-factor LED lamps that are transformer compatible, such as LED G4 bi-pins that are the same size as the small halogen bi-pin capsules they replace. The low component count also makes for a cost-effective solution. ■

LED Mounting Bases - Tiny MCPCBs for Lumileds Luxeon Z

LED Mounting Bases launches the smallest MCPCB for Luxeon Z (5 x 5 mm) and for 4 LEDs Luxeon Z, extending the range of applications. The new 5 x 5 mm MCPCB for Lumileds Luxeon Z can easily be integrated into the tiniest spaces, alone or clustered. "This exclusive feature offers greater freedom of conception as it enables even smaller and unique luminaire designs for indoor, technical and even biological lighting", explains Mr Espérance, CEO of LED Mounting Bases.

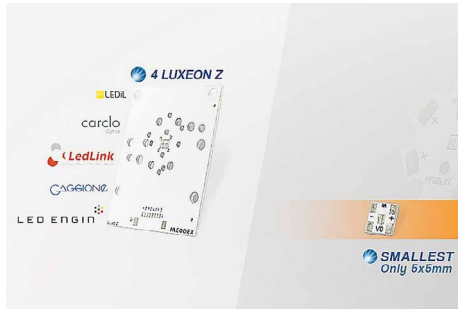

LED Mounting Bases' MCPCBs for Lumileds Luxeon Z is the smallest product type of its kind

The clever MCPCB for 4 LEDs Luxeon Z multi-lenses is, for its part, compatible with various LED Lenses manufacturers such as LEDil, GAGGIONE, CARCLO, LEDENGIN and LEDLINK. This characteristic allows the user to perform several tests on a single circuit, making it ideal for prototyping at lower cost.

Among a wide range of innovative and high-quality products made in France, LED Mounting Bases offers hundreds of other MCPCBs, like the multi-footprint MCPCB for LED Tests and LEDiL LED Lens compatible. ■

Gi Plast Introduced Heat-Control-Line at LpS 2015

Whenever it comes to IP it is essential to protect the whole lamp and electronic from particles and water coming from the outside. The higher the IP-rate the more the lamp is protected or even sealed against anything pouring in. But what actually happens inside of the lamp?



Gi Plast's Heat-Control-Line is based on thermally conductive plastics with 10 times higher thermal conductivity than conventional plastics

EVERFINE

Make every customer more satisfied

Quality LED & Lighting Measurement Instrument

HAAS-2000/3000 HIGH ACCURACY ARRAY SPECTRORADIOMETER

- ◆ USA and China Patents Granted
- ◆ Widely applied in accredited laboratories
- ◆ Leading specifications
- ◆ Applicable for both steady state and transient (pulses) measurement



More  www.everfine.net

If nothing can come in, nothing can come out! In LEDs and other electronic equipment current is flowing constantly, once the lamp is lit up, and due to Joule's heating effect the temperatures in the lamp rise and rise. This heat is trapped in the lamp and since it can hardly flow out, it will shorten and even endanger the life of LEDs and plastic covers.

With the vision to optimize any lighting process, we have developed the new Heat-Control-Line: the in-built solution to make heat flow directly to the outside of IP-lamps. Thermally conductive plastic is the key to make heat flow ten times more efficiently than normal plastic parts, which prevents LEDs and other components from being affected by heating damages.

By using extruded plastic, design possibilities are endless. There are no limitations given by commonly used components. Being extruded also means that anything is bound together, allowing no flaw or gap in the body of the lamp, observing highest IP-rates. Whichever limitation is set to lighting design, we improve to overcome it and make solutions become reality. ■

ESCATEC Introduces Ten Times More Efficient LED Heat Spreader

ESCATEC, one of Europe's leading providers of contract design and manufacturing services, launched its solution to the challenge of effectively cooling high brightness LEDs at the LpS 2015 in Bregenz.



ESCATEC's Heat Spreader dissipates heat of HP LEDs ten times faster than existing solutions

ESCATEC's Heat Spreader solution solders the LEDs onto a copper substrate, which is up to ten times more effective at dissipating the heat generated by the LEDs than current solutions. The CoolRunning design means that LEDs with a power density of up to 10 W per mm² could be passively cooled.

The Heat Spreader was developed in response to a customer visit to ESCATEC's FutureLab where novel and innovative solutions are developed for LED applications. "Heat dissipation is always a challenge for LEDs as their compact size means that the LEDs can be packed close together to form a powerful illumination source but that also forms a highly concentrated heat source, for example, when a hundred 5 Amp LEDs are side by side," explained Wolfgang Plank, manager of the FutureLab. "Our novel heat spreader solution opens up compact, high power LEDs of, say 1000 W, to be used in many new applications such as stage lighting, architectural illumination and video projectors."

By starting from the bare LED die, ESCATEC can customize the solution with regards to the size of the package, the shape of the beam so that there are minimal losses, and the wavelength of the light along with its intensity. This freedom of design enables the LED solution to be highly efficient, appropriately cooled and optimized for the required power consumption. It also enables the lens or lens array to be custom made to provide the exact optics required by the application and ensures that design can be compact with high optical efficiency. ■

GL Optic Introduced TEC Control System at LpS 2015

GL Optic, has introduced a new complete temperature regulation and control solution for LED measurements. The GL TEC Control System includes a spectrometer, integrating sphere, programmable power supply and sophisticated software in a well-harmonized set. The GL TEC Control System is used in development labs for test and development of new LED drivers, LED chips and lights.



GL Optic's TEC Control System is a light measurement system including a complete LED lighting heat control solution

Light measurements on LED lighting now extend beyond the realm of conventional optical measurements to include the effects of electrical and thermal operating variables on the optical parameters of LEDs. This raises the bar for lighting manufacturers and developers who in the past have relied on simple applications using integrating spheres. New industry standards require reliable, stable conditions for surface temperatures and power supplies. This in turn creates the need to regulate and stabilize the temperature of high-power LEDs during the measurements or to simulate various LED operating temperatures. New test standards such as CIE S 025/E:2015 force lighting manufacturers and developers to place greater emphasis on heat control.

This has created an incentive for GL Optic to develop a complete heat regulation solution. The GL TEC Control System includes the lab-grade GL Spectis 6.0 spectrometer and TEC Mount with Peltier element for cooling or heating connected to a cutting-edge TEC controller which performs the control functions and displays the temperature. Both in turn are connected to a GL Opti Sphere 500 integrating sphere and a programmable power supply. Based on high-precision temperature monitoring and control, the module creates stable measurement conditions and can simulate nearly any operating temperature. Heat control is managed by GL Automation, a powerful tool which is part of the GL Spectrosoft software package. It is used to operate all of the attached instrumentation or to plan, conduct and monitor automated test scenarios.

If you are looking for reliable, high-precision spectrometers and controllable light measurement systems with intuitive operation, the cutting-edge GL TEC Control systems are your best option. They meet all of your spectral light measurement needs. ■

Mühlbauer - All-New "Reel to Reel Flip Chip" LED Assembly Equipment

Mühlbauer presented its latest development of "Reel to Reel Flip Chip LED" at the LpS 2015. A completely new technology which allows the production of LED light engines directly on a flexible substrate.

TAIWAN INT'L TILS LIGHTING SHOW

台灣國際照明科技展

In conjunction with
LED Taiwan 2016

Welcome to **Global**
Lighthouse Taiwan
Dazzling Prospects!



AD by BOFT



FEATURING:

- Home/Residential Lighting
- Commercial Lighting
- Intelligent Lighting **NEW!!**
- Outdoor Lighting
- Lighting for Kitchen & Furniture
- Plant Factory & Lighting
- Automotive Lighting
- Special Lighting
- Health Care and Institutional Lighting **NEW!!**
- Medical, Cosmetic and Beauty Lighting **NEW!!**
- Building Material & Lighting Applications
- Lighting Accessories
- Lighting Production Equipment
- Test & Inspection Equipment

APR. 13-16 2016

Taipei Nangang Exhibition Center, Hall 1

www.TILS.com.tw



Organized by:
Bureau of Foreign Trade, MOEA



Implemented by:
TAITRA
www.taipeitradeshows.com.tw



TLFEA
www.lighting.org.tw



Supported by:
China Economic News Service



The integrative process for Mühlbauer's new production process is based on a wafer-level packaging (WLP) approach

Key Features:

- LED light engines are produced directly on flexible tape (-> from raw material directly to level 2 assembly)
- Reel to Reel production mode with only one machine from Epoxy, to Flip Chip LED, incl. SMD attach, curing and final test
- Saves up to 30 percent on production cost especially due to the now redundant gold wires and significantly lowered costs of ownership
- Easy handling and fast production process with up to 20,000 UPH

The light engine itself is manufactured by the latest Flip Chip technology. The system uses a high-volume Reel to Reel procedure, placing the flipped LEDs directly on the endless web material, i.e. onto the final design level 2 light engine. The integrative process is based on a wafer-level packaging (WLP) approach and consists of three basic steps: the bonding of LEDs (and other components like diodes, power control components, connectors), the dispensing of the lenses or phosphors, and the final test.

In general, the "Reel to Reel Flip Chip LED" has several advantages over the current conventional technologies on the market. In the first place and most important, it saves up to 30% on the LED production costs. The cost savings are due to the now redundant gold wires, as well as to the

significantly lower investment required by the production equipment. In the second place, the production process is faster and easier to handle. With up to 20,000 units per hour the systems are achieving significantly higher production speeds. Due to the Reel to Reel procedure, a lot of the current subassembly steps can be omitted.

The introduced technology is based on Flip Chip Reel to Reel, which has already been proven in Mühlbauer's RFID division and is now adapted to LED applications according to customer requirements. In the RFID market, which is entering the high-volume phase right now, the leading topics are highest yield in combination with materials at competitive costs, thereby reflecting a similar situation to the LED market. ■

Shin-Etsu's New Silicone for Superior R_{TH} and Clarity for HB LEDs

As an innovative response to meet the increasing demands (higher heat/brightness characteristics) of cutting-edge LED technologies, Shin-Etsu Silicones of America (SESA: A U.S. subsidiary of Shin-Etsu Chemical Co. Ltd., Japan) has recently introduced its new optically clear LIMS X-34-1972-3 material.



Shin-Etsu Silicones' new LIMS X-34-1972-3 is highly transparent and durable

LIMS X-34-1972-3 Properties:

- Viscosity (A/B): 450/450 Pa.s
- Hardness: 70 A
- Tensile Strength: 7.5 MPa
- Tear Strength: 12 kN/m
- Refractive Index: 1.41
- Transparency: 95%

With a transparency of 95%, the new material is uniquely engineered and ideal for expanding LED applications in street lighting, automotive, and exterior illumination. Notably, its superior high temperature resistance compared to thermoplastic resins allows molded silicone optics to be positioned in close proximity to the LED light source without yellowing or cracking over extended operating life spans.

According to SESA's North America Marketing Manager, Eric Bishop, "Next-generation HBLED systems are getting hotter as light output continues to increase. The advanced engineering properties of our X-34-1972-3 material delivers unparalleled heat resistance and clarity at these higher operating temperatures."

Bishop also noted that the material has been tested in-house and at customers with promising results. Additionally, the optically clear LIMS X-34-1972-3 material will be on display during SESA's open-house demonstration at their LIMSTTM Technical Center in Akron, Ohio on Monday, October 12th (1:00 pm – 5:00 pm). The informal event will feature the production of 100% silicones magnifying lenses and the opportunity to network with industry suppliers and associates. ■

WEBINARS



CoolMOSTM CE and LED Driver ICs - The Ideal Combination from LED Tubes to LED Drivers

Learn more about CoolMOSTM CE, the proven benefits of superjunction technology, and the powerful combination of CoolMOSTM CE and the suitable LED Driver ICs.

Watch our webinar!

www.led-professional.com/Infineon-Webinar



Philips Advance Xitanium

40W Linear 120-277V 0.1-1.1A SR Indoor LED Driver



The Xitanium SR LED driver reduces complexity and cost of light fixtures used in wireless connected lighting systems. It features a standard digital interface to enable direct connection to any suitable RF sensor on the market. Functionality is integrated into the SR driver that ordinarily would require additional auxiliary components. The result is a simpler, less expensive light fixture that can enable every fixture to become a wireless node.

Features

- Standard digital interface based on DALI 2.0
- Auxiliary power for sensors
- Occupancy and accurate energy reporting
- Dim-to-off capability
- Drive current setting via SimpleSet wireless programming or Rset2

Applications

- Indoor linear applications

Benefits

- Enables wireless interoperability with multiple sensors/network systems
- Reduces complexity and cost of fixture by eliminating auxiliary components ordinarily required for powering sensors, switching fixture off and monitoring energy use
- 5-year limited warranty*

* View limited warranty at usa.lighting.philips.com/connect/tools_literature/warranties.wpd for details and restrictions.

PHILIPS

Authorized Distributor

FUTURE
Lighting Solutions
Making LED Lighting Solutions Simple™

www.FutureLightingSolutions.com

FAU Researchers - White LEDs Based on Fluorescent Proteins

LEDs are up to 80 percent more energy-efficient than normal light bulbs and last around five times as long as energy-saving light bulbs. As a result they are being used more and more frequently as a source of light. Nevertheless, white LEDs still have room for improvement, as current manufacturing processes are either very expensive or result in the lifetime of the LEDs being reduced. Researchers at FAU have now developed a new, rather unusual manufacturing method: their LEDs are partly made of fluorescent proteins.

In our homes and in street lights, in traffic lights and in screens – LEDs are an essential part of our everyday lives. They have a long lifetime, are highly energy-efficient and environmentally friendly, and require little maintenance. However, manufacturing white LEDs is complicated.

Finding the perfect combination:

Research is currently focusing on two ways that could be used to make white LEDs in the future, both of which have their disadvantages. In the first method, thin layers of inorganic materials such as phosphorous or rare earth elements are applied to a blue LED. The resulting LEDs have a long lifetime and emit light with the optimum strength. However, as rare earth elements are used and the manufacturing process is complex, the production costs are extremely high and are not sustainable. The alternative is to use organic LEDs in which several organic semiconductor layers are sandwiched between two electrodes. These LEDs have a lower performance and shorter lifetime than their inorganic counterparts. The optimum solution, therefore, would be a combination of the two versions which has the advantages of both methods.



Gel-like networks consist of a concentrated aqueous protein solution and a polymer compound (Image: Michael Weber)

FAU researchers have now succeeded in creating exactly this kind of combination – with the help of fluorescent proteins that are embedded in a rubber-like material and applied to an LED. Dr. Rubén D. Costa from FAU's Cluster of Excellence 'Engineering of Advanced Materials' (EAM) and his colleague Prof. Dr. Uwe Sonnewald from the FAU Emerging Fields Project 'Synthetic Biology' collaborated on the research.

Proteins in a gel bed:

"The fluorescent proteins combine the desired elements," explains Dr. Rubén D. Costa from the Division of Physical Chemistry I. "They are environmentally friendly and inexpensive to manufacture. In addition, the proteins allow the color setting – either colored or white – to be controlled easily."

However, there is one snag: the proteins are only stable in an aqueous buffer solution, meaning that it is not possible to use standard coating procedures. The researchers also had to ensure that the proteins would work stably under various environmental conditions, such as at high temperatures or humidity.

Their solution was to develop a new coating technique. They embedded the proteins in a gel that consisted of a concentrated aqueous protein solution and a polymer compound. The polymers bind the aqueous protein solution to make a gel-like network while ensuring that the necessary moisture is retained. The gel is then vacuum dried, turning it into a rubber-like material that is suitable for multilayer coating of LEDs and protects the proteins from external influences.

"With our method we have managed to create long-lasting and efficient white LEDs using an environmentally friendly and inexpensive manufacturing process. This is a pioneering method for future generations of LEDs," Dr. Costa explained.

Excellent research:

Around 200 researchers are developing new materials at FAU's Cluster of Excellence 'Engineering of Advanced Materials' (EAM). In over 90 projects, researchers from nine disciplines (applied mathematics, chemical and biological engineering, chemistry, electrical engineering, computer science, medicine, mechanical engineering, physics, and materials science) are working on each stage of the process chain, from basic molecules to finished materials.

FAU established the Emerging Fields Initiative (EFI) in 2010 with the aim of identifying outstanding and preferably interdisciplinary research projects at an early stage, and providing them with support and funding in a non-bureaucratic way. After the first two rounds of applications, 18 EFI projects have so far received a total of 12 million Euros in funding. ■

The researchers recently published their findings in the renowned journal *Advanced Materials*. The article is available at <http://dx.doi.org/10.1002/adma.201502349>.

WEBINARS



Modeling Color Effects in Modern Optical Analysis Software - by Lambda Research

Lambda Research Corporation will present a comprehensive webinar on smart designs to model color effects in LED lighting systems using modern optical analysis software.

Register to view the webinar and to download the presentation!

www.led-professional.com/lambda-color-effects

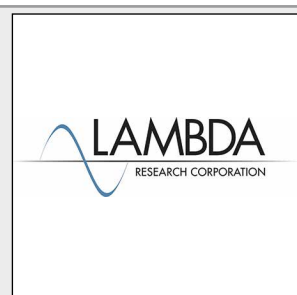

Philips Fortimo LED Strips

0.5ft 550lm, 1ft 1100lm and 2ft 2200lm 1R LV3 Modules



Fortimo LED Strip systems are ideal for use in narrow width luminaire designs for architectural applications that were not possible with fluorescent lighting before. Fortimo LED Strips offer best-in-class module efficiency of up to 163lm/W.

Features

- Narrow width (20mm)
- High CRI options (CRI90) and 3 SDCM color consistency
- Variation of color temperatures (3000K, 3500K, 4000K and 5000K)
- Zhaga compliant

Applications

- Office/Industry/Retail

Benefits

- Slim width enables optimized luminaire design and new form factors
- High color rendering and excellent color consistency brings linear LED lighting to the next level for quality of light
- 5-year limited system warranty with Philips Advance Xitanium LED Drivers*

* View limited warranty at usa.lighting.philips.com/connect/tools_literature/warranties.wpd for details and restrictions.

PHILIPS

Authorized Distributor

FUTURE
Lighting Solutions
Making LED Lighting Solutions Simple™

www.FutureLightingSolutions.com

TECHNICAL REGULATORY COMPLIANCE UPDATE



Segment	Product	Standard (Certification)	Region	Technical Regulatory Compliance Information
Lighting	LED Tubes, Lamps and bulbs	SAA (Standard Association of Australia)	Australia	According to the new SAA approvals published on 13 th Feb 2015, all the new LED tubes entering the lighting market must cover the requirements that are stated in AS/NZS 60598.2.1:2014. It now features Amendment A which contains all required testing for LED tubes. The transition period is 2 years and all changes need to be made by 12 th Feb. 2017.
Lighting	Lamps	Energy Efficiency: Energy Label	Ecuador	The permissible ratings and design regulations have changed for all the domestically manufactured lamps in Ecuador. The manufacturer has to take a note that for availing the Energy Label for lamps, the lamps should have nominal power rating between 4 W and 500 W. Furthermore its voltage rating should not exceed 250 volts. These limits are to be achieved keeping in mind the energy efficiency of the product.
Lighting	Tungsten Halogen Lamps	Energy Efficiency	China	The minimum values of energy efficiency for tungsten halogen lamps is revised according to the standard GB 31276-2014 coming into force on September 01 st , 2015.
Electrical and Electronics	Lighting	2009/125/EC	Europe	The EU has amended the lighting regulations (EC) 244/2009, (EC) 245/2009, (EU)1194/2012 by regulation (EU)2015/1428 on 25.August 2015 in order to harmonize the different regulations especially concerning the special purpose lamps and products, and to shift in regulation (EC)244/2009 the stage 6 from 1.Sept. 2016 to 1. Sept. 2018 The regulation (EU)2015/1428 comes into force on 28. Feb. 2015. The stage 3 of (EU)1194/2012 was not changed and it remains on 1 Sept. 2016.
Electrical and Electronics	Low voltage products	2014/30/EU (CE Marking)	Worldwide	The new Directive 2014/53/EU of the European Parliament and of the Council of 16 April 2014 on the harmonisation of the laws of the Member States relating to the making available on the market of radio equipment and repealing Directive 1999/5/EC has been published on the OJEU L 153, 22.5.2014, p. 62–106. It will be applicable from 13 June 2016. The Voluntary Attestation of conformity has to be done according to the EMC-Directive. The new test report for each product falling under this category has to be provided before the deadline.
Electrical and Electronics	Electrical and Electronic products	(CE Marking) 2014/30/EU 2014/30/EU 2014/53/EU	Europe	New directives for placing electrical and electronic product on the EU market have been published and repealing others with effect in 2016. Directive 2014/35/EU coming in force on 20. April 2016 is repealing 2006/95/EC for Electrical equipment designed for use within certain voltage limits (LVD). Directive 2014/30/EU coming in force on 20. April 2016 is repealing 2004/108/EC for electric magnetic compatibility (EMC). Directive 2014/53/EU coming in force 13. June 2016 for radio equipment directive (RED) and is superseding 1999/5/EC for RTTE. Manufacturer needs to update and complete their technical documentation file and declarations of conformity before placing new products on the market after the deadlines.
Electrical and Electronics	External Power Supplies	Energy Efficiency ErP	USA	The regulation for External Power Supplies was revised in USA effective from 24. Sept. 2015. It affects (10 CFR 429.37) External Power Supplies, (10 CFR 430.2) Definitions, (10 CFR 430.3) Material incorporated by reference and (10 CFR 430) Appendix Z Uniform Test Method for Measuring the Energy Consumption of External Power Supplies. The changes will affect external power supplies (EPS) manufactured on or after 10 Feb. 2016: - Direct operation EPS shall meet level VI (all classes of EPS) - Indirect Operation EPS shall meet level IV (only class A EPS) The revised regulation now also includes test methods for Adaptive EPS's and it includes practices of IEC 62301 ed. 2.0.
Batteries	Consumer Batteries	EN 60950-1, EN 60065, EN 60335, EN 61010-1, EN 62133, EN 60598	Europe	The rechargeable battery packs as well as the used cells are to be tested according to DIN EN 62133. The battery pack is in addition to be tested with the end product/charging unit for which it is intended. For lithium cells and batteries verifications about the UN transportation regulation 38.3 must be given.
IT Equipment	External Power Supplies, Computers, Television Sets	Energy Efficiency Energy Star	Worldwide	Environmental Protection Agency (EPA) published that the Single- and Multiple-voltage external power supplies shall meet the Level V or higher performance requirements under the International Efficiency Marking Protocol and that the test method 10CFR430. Energy Conservation program for Consumer products Appendix Z has to be used for measuring the external power supplies. In Australia, Level VI is accepted but not promoted while in USA Level VI is already in promotion. For Europe, Level VI will come into existence from 2017

Disclaimer: This information is research work of TÜV SÜD Product Service and is intended for general information purposes only. The content is publishable only after having the consent of TÜV SÜD Product Service. If it is published with any changes, the company is not liable for it. The information is subject to change and all rights for it are reserved by TÜV SÜD Product Service GmbH.

Philips Fortimo LED Spotlight

Module Gen 4



The Fortimo LED SLM Gen 4 is a next generation solution for spotlight and downlight applications. Philips provides a system proposition ranging from 1100 Lumen to 4500 Lumen in preset outputs, with the flexibility to tune as per the OEM's needs. The product leverages the latest Chip-on-Board LED technology with a Zhaga Book 3 compliant holder. Being a low voltage UL Class II electrical design and a UL recognized component, Fortimo LED SLM Gen 4 enables easy design-in with Philips Advance Xitanium LED Drivers.

Features

- High energy efficacy of up to 130lm/W nominal
- High thermal capability with Tc life up to 95°C for 50,000-hour lifetime (L70)
- Zhaga book 3 compliant holder
- Crisp White color point for vibrant and crisp color rendering
- UL recognized, LM80 available

Applications

- Retail/Hospitality/Supermarkets

Benefits

- Quality of light and punch
- Easy to design-in including UL and LM80

PHILIPS

Authorized Distributor

FUTURE
Lighting Solutions
Making LED Lighting Solutions Simple™

www.FutureLightingSolutions.com

Tech-Talks BREGENZ - Dr. Jy Bhardwaj, Lumileds, CTO

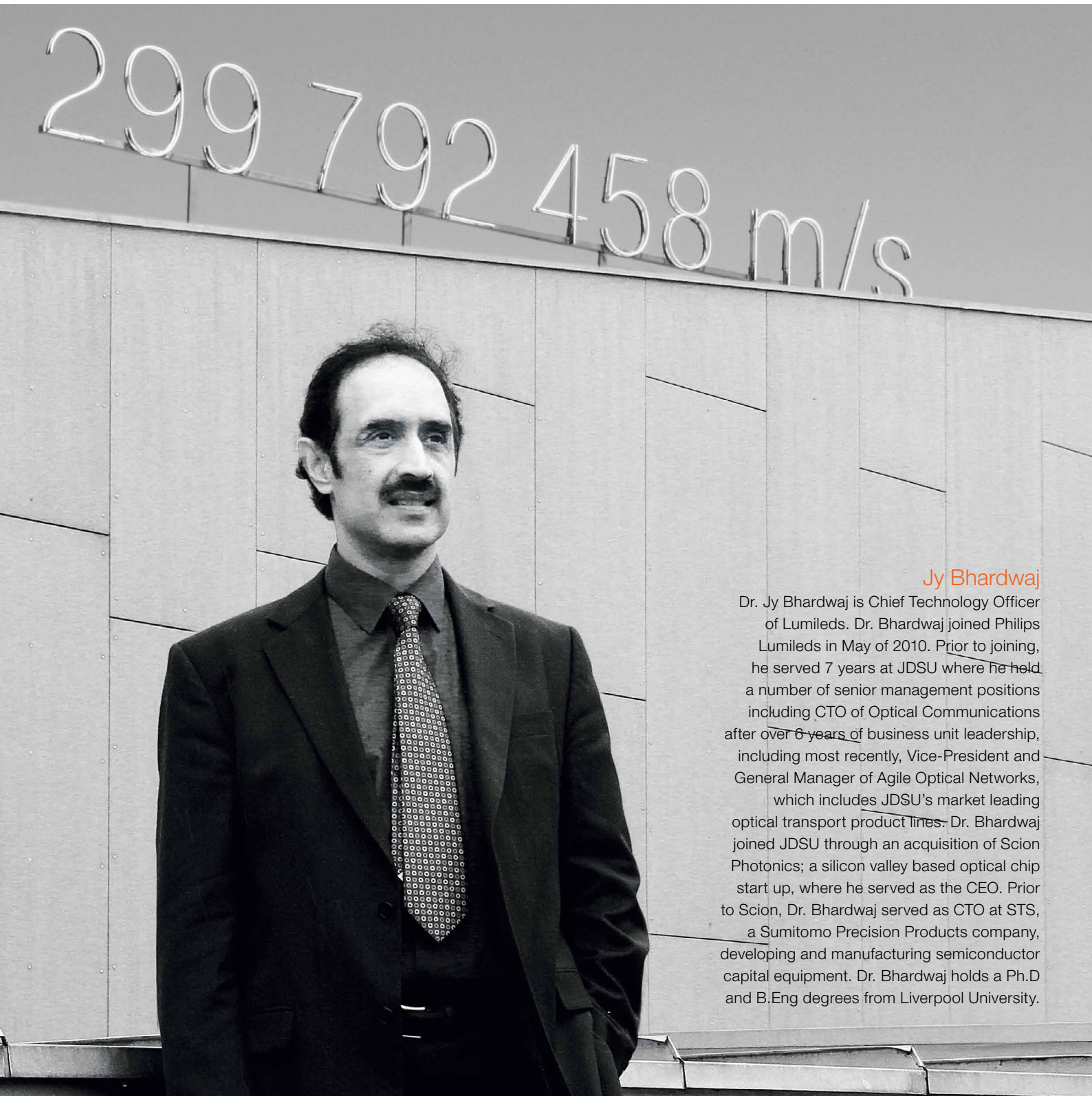

Jy Bhardwaj

Dr. Jy Bhardwaj is Chief Technology Officer of Lumileds. Dr. Bhardwaj joined Philips Lumileds in May of 2010. Prior to joining, he served 7 years at JDSU where he held a number of senior management positions including CTO of Optical Communications after over 6 years of business unit leadership, including most recently, Vice-President and General Manager of Agile Optical Networks, which includes JDSU's market leading optical transport product lines. Dr. Bhardwaj joined JDSU through an acquisition of Scion Photonics; a silicon valley based optical chip start up, where he served as the CEO. Prior to Scion, Dr. Bhardwaj served as CTO at STS, a Sumitomo Precision Products company, developing and manufacturing semiconductor capital equipment. Dr. Bhardwaj holds a Ph.D and B.Eng degrees from Liverpool University.

Dr. Jy Bhardwaj, CTO at Lumileds, held a keynote speech at the 5th LED professional Symposium +Expo (LpS 2015) on September 22nd in Bregenz. He talked about “Trends and Challenges for System Integration” and pointed out further steps and phases of how lighting technologies will evolve. Arno Grabher-Meyer and Siegfried Luger talked with Dr. Bhardwaj about his view on embedded lighting, color LED technologies, substrate and light source technologies.

LED professional: Yesterday, in your keynote you mentioned a very interesting perspective of lighting trends based on a three-phase model. Could you elaborate?

Jy Bhardwaj: Phase 1 is socket replacement. Here you would just change the bulb in the luminaire. In phase 2 you're taking LEDs out of the lamps and putting them onto boards - creating very flexible architectures. In phase 2 we see very beautiful designs but also connectivity and the integration into networks. Phase 3 is the future vision. LEDs get integrated into the infrastructure, or let's say, embedded. Instead of points of light there will be ceilings of light or walls of light. LEDs will be integrated into work surfaces, tables and all kinds of different things.

LED professional: How will this embedding of LEDs work with different end product manufacturers?

Jy Bhardwaj: Let's look at some examples: One is the integration of LEDs into tiles; the other is their integration into carpets. For example, when you turn the LEDs on you can write messages on the carpet or lead the way with arrows. The light sources are in the products; they are embedded into the final products. So, it's not about an LED manufacturer making a carpet it's about the carpet manufacturer adding LEDs to his product, or a clothing manufacturer integrating LEDs into his products, or the ceiling tile manufacturer adding LEDs to his products. Right now, Philips is working with a tile manufacturer to create ceiling tiles. They look like every other ceiling type until you turn them on.

LED professional: Will most of the light sources be embedded in phase 3? What about the transition into the embedded lighting world?

Jy Bhardwaj: Not every light source will be embedded. The reason is that we always want point light sources as well for designs or to create moods. The luminaires play a

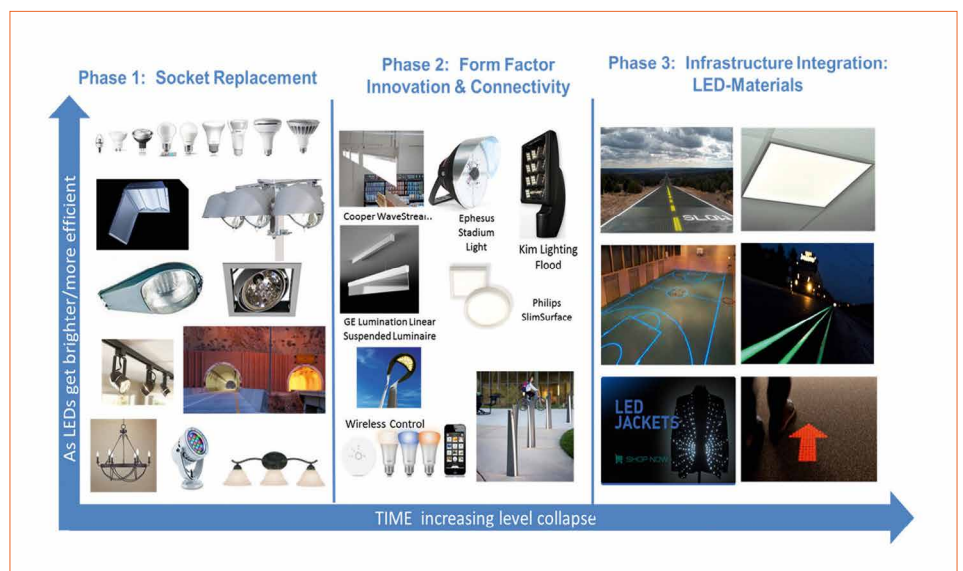

The three evolutionary steps of LED lighting from replacement to infrastructure integration with some examples

very important role there. If you look at how lighting evolves, it is a huge legacy business. Replacing existing sockets will take a long time. The brown field, which is the retrofit cycle of what is there already, is the far bigger market than the green field. The green field, which is new buildings, is much less. The question is when to design this into buildings. It's about starting to have confidence in the reliability and the longevity of the LEDs; it's a question of redundancy, robustness and the adaptability of LEDs. When that is real, then the designers will build it into the applications and then go further into the next phase. Maybe semantic light is an example of the end place it could be. And the solution should be within the light to carry information. But you want that information to provide value and semantic light can provide value when you are shopping. You can see that in retail; particularly high-end design where they can afford something like this. It can work.

LED professional: What do these trends mean for Lumileds as a component manufacturer? Do you have to adapt your portfolio to these developments or do you work with completely new clients?

Jy Bhardwaj: What it means for Lumileds is that we have to continue to make a range of LED solutions that can be used across a very broad range of applications, like, for example, stadium lighting or street lighting, where we need the directionality of the product and where we need very high lumen outputs. But people are beginning to become aware of glaring and we're trying to limit that. That limits how much power you can put into some of the lighting applications. The other range is distributed lighting. When I look at the ceiling I only want to see distributed light. That's mid-power and low-power LEDs.

LEDs are being attached in a certain way in a certain form factor for boards. Whether it's mid-power, high-power or low power, they are all designed for board engineering. And we are moving towards SMT so you can use automatic pick-and-place tools in production. Now the challenges become how to use the same SMT techniques in a ceiling tile manufacturers or carpet manufacturers line in a volume-manufacturing set-up.

LED professional: Are you familiar with the approach from iMac? They have the small LEDs on a bendable substrate.

Jy Bhardwaj calculated that the incompatibility between products and different controls options is one of the most critical issues hindering fast market adoption and user confidence. He proposed improving scalability and adaptability by using common API's

Jy Bhardwaj: Philips has developed the exact same type of thing. You can attach the LEDs on a small form factor and then you can stretch it and you create whatever dimension you want and you can light it up with a certain amount of current to make it as bright as you want. Those types of technologies are being developed, but again, our job as an LED manufacturer is to make sure that for these form factors we can provide reliable LEDs that are the right size and that perform right with the right power ranges. In particular, it's LEDs that we can then supply with high consistency and very high volume, because that's what these applications are going to demand.

LED professional: Will you offer manufacturing service support for these new technologies and applications?

Jy Bhardwaj: We are not in the business of, let's say, carpet manufacturing, so we will stay in the component business and its support. Don't forget that these things take a long time to develop and become significant in volume. So in order to get the whole industry comfortable with LEDs as a robust, reliable product it is important to adapt standards that allow people to mix different vendors as well.

The most the critical aspect is controlling LEDs remotely and to power them in a way that is distributed. Now we are trying to bring the industry up to speed. We need to consider how we power LEDs and drive standards because unless we do this, whatever we design will be a single design, which has no chance of any broad market acceptance.

LED professional: Are there any results available coming out of this standardization process so far?

Jy Bhardwaj: Well we are just starting. But first of all the message is that we need to push for building standards, network standards and APIs for power distribution. Then I think we'll get the industry in the right

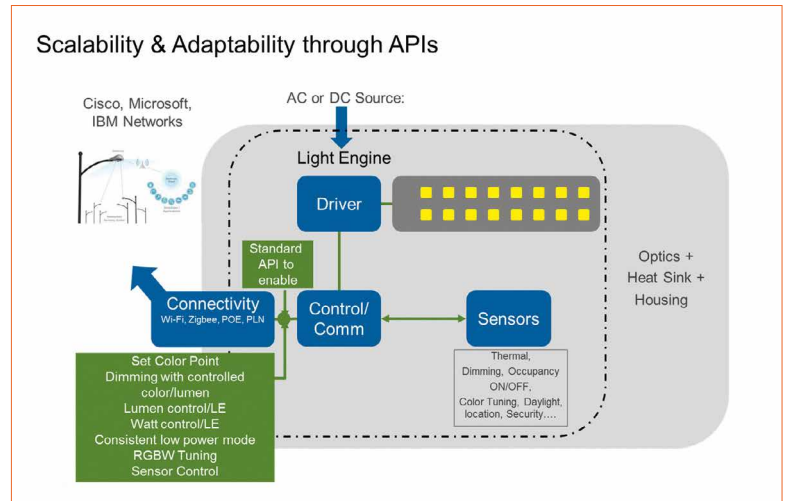

place to begin to consider volume applications of distributed light embedding.

LED professional: Let's touch on another topic. Lumileds launched the LUXEON C product portfolio here at the LpS 2015. Could you give us some background information?

Jy Bhardwaj: The LUXEON C is a very important product for the color lighting industry such as architectural lighting, mood lighting, even functional lighting for emergency vehicles. What makes it unique is the flexibility in arranging the LEDs and being able to use the LEDs like any other device. The LUXEON C Color Line is an optically advanced portfolio of color and white LEDs. Designed for flawless color mixing, LUXEON C has one focal length for all colors, which provides consistent radiation patterns from secondary optics and it maximizes optical efficiency. We have developed a very small dome that leads to the best compromise with extraction, efficiency and being able to maintain the beam angle. With a big dome the light comes out in all directions. This leads to the halo effect. The LUXEON C eliminates this effect. On the packaging side we have designed the LEDs, so that every single part has the same thermal resistance to optimize the board design.

LED professional: Why did you launch this color product line right now and how long did the development take?

Jy Bhardwaj: It's really taking us a while to work with people who are at the forefront in the fields of architectural lights and mood effects. Trying to engineer the colors in a particular way, trying to reduce the form factors, reduce the optics and hit all these challenges. In total the LUXEON C development was about 18 months.

LED professional: Is the base substrate of LUXEON C still sapphire? What about other substrate materials like silicon?

Jy Bhardwaj: The base material of the LUXEON C for growing the EPI is still sapphire for the blue and green LEDs and obviously gallium oxide for the AlInGaP red type. We don't see any changes here. Silicon versus sapphire is an interesting discussion. We actually invested very heavily in GaN on silicon. We came to the conclusion, a couple of years ago, that this was not going to be the right solution. And the reason we came to this conclusion was that even over the five years that we were working in this technology, the sapphire performance always stayed ahead of silicon. We're producing all our LEDs on 6-inch wafers, even the red ones. 6-inch wafers are the maximum and the optimum size, we think. We applied that very early on when sapphire was very expensive at 6-inch. It was a factor of 3 to 5 higher than silicon and at that point silicon looks very attractive. Sapphire costs have come down so fast, as we ramped up in volume and developed

the supply chain. Now the difference between the two substrates is maybe a factor of less than two. When you get to a factor of less than two, and you look at that in terms of cents per square millimeter, the difference is just a fraction of a cent per square millimeter.

One final point on Silicon, which is the punch line of the story: I was explaining how the silicon wafer is cheaper, wafer fab is cheaper, maybe saves you half a cent or a cent, but the performance is worse. The rule of thumb is that 15 percent decrease in efficacy costs you double the EPI area.

LED professional: How do you compare sapphire LEDs to GaN-on-GaN technology?

Jy Bhardwaj: GaN-on-GaN becomes very interesting when you are driving it with very high current densities. The breakeven is around about two to three amps per square millimeter. That's very high. So above that you begin to see some advantages. If you look at our improvements in droop that is being pushed out. We estimate within a year the breakeven will be about three amps per square millimeter. So now, how many devices am I going to operate above three amps per square millimeter? The negative thing is, I begin to make smaller and smaller devices. The problem isn't

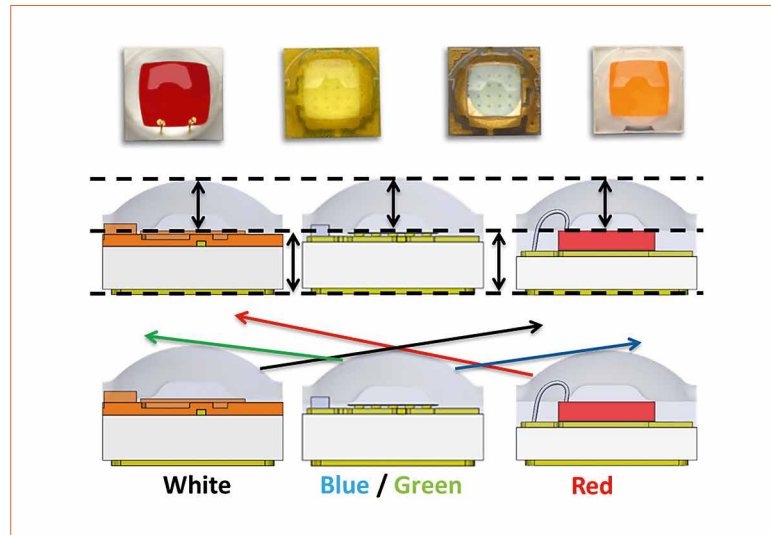

Equalizing optical properties and other technical parameters of different technology LEDs is a relevant step that would make the lives of designers and engineers easier

how hard I can drive this device; the problem is the thermal distribution underneath it. I've got to take the heat out, so I can't drive it harder than the thermal dissipation and the problem is that the phosphors are temperature sensitive as well. Also the silicone is temperature sensitive. 150°C is about the threshold limit.

LED professional: Do you think that laser light will come into general lighting applications in buildings or will it stay for automotive and for high beam focused applications?

Jy Bhardwaj: For general lighting, some people are saying that you could see some applications coming in with laser light where you want very high light intensity. Maybe for stadium lighting but for street

lighting, I doubt it. You exchange one sort of problem for another sort of problem- ending up with more glare.

LED professional: It's the first time you are at the LpS. What is your impression of the show so far?

Jy Bhardwaj: I think the show is excellent. It has a lot of very good papers. The quality is good. The people who are attending are certainly in touch with the industry and participating very deeply within the industry. So you have the key suppliers here, you have major customers here. It's a very good eco system.

LED professional: Thank you very much for this interview and enjoy your stay in Bregenz. ■

LpS 2015 – Focus on Design and Applications for Sustainable Solutions

Since LED technology has matured over time, one would think a technology focused event would be obsolete. Far from it! The LpS 2015 was more attractive than ever with new activities and offers. Arno Grabher-Meyer from LED professional has summarized the most important proceedings and discusses selected lectures and the final Tech Panel.

2015 is not just the International Year of Light, but also the year that LED professional celebrates the 50th edition of the LED professional Review and the fifth LED professional Symposium +Expo. In celebration of these important occasions, LED professional instigated a media wall that was used by exhibitors and attendees

during the whole event as a way to communicate their experiences with the rest of the world. This year, the number of lectures, the amount of exhibitors and the quantity of product launches increased dramatically – a demonstration of the increasing importance of this event for the LED lighting industry. But although the

quantity is important, the quality and the focus are paramount. The symposium program as well as the workshops had more momentum and by strengthening the application point of view and integrating the design aspects it was possible to cover valuable and important topics. This resulted in an even more solution-focused event.

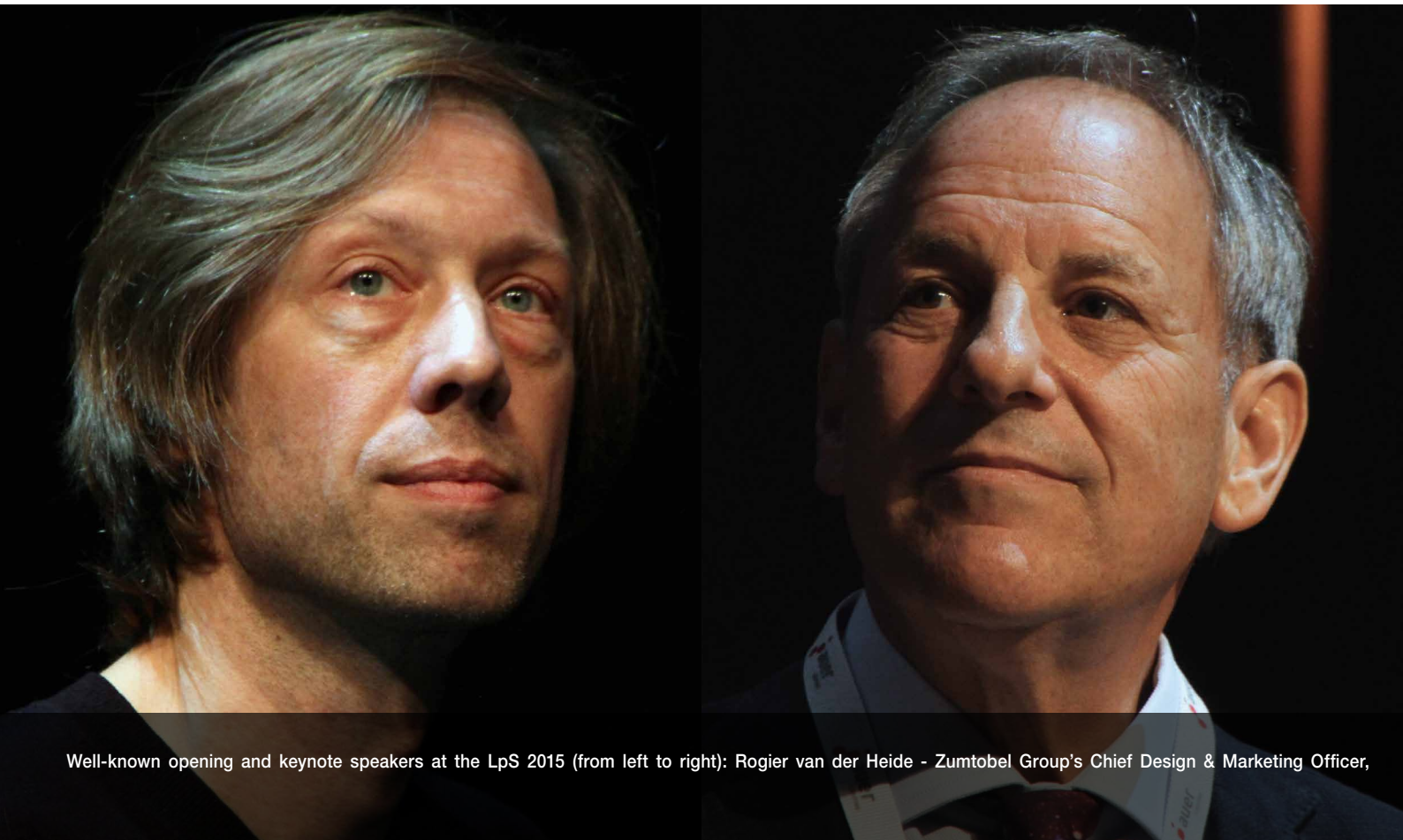

Well-known opening and keynote speakers at the LpS 2015 (from left to right): Rogier van der Heide - Zumtobel Group's Chief Design & Marketing Officer,

In Short

Around 1,400 attendees and visitors came to the LpS 2015 to take part in around 60 lectures and 7 workshops and visited over 100 companies in the exhibition area. The tremendous growth of the exhibition area to 115 booths in total and the presence of the seven biggest LED manufacturers, worldwide, made the event especially attractive for many participants. The visitors came from industry and academia alike. The majority group was engineers with 30% followed by 22% sales and businesspersons and over 18% from the corporate level (CEO, CTO, etc.). Planners, designers and architects made up 7%, while 2% came from the field of education and 1% were journalists. The remaining 20% were not specified.

As in the past years, Mr. Siegfried Luger led the opening ceremony by explaining this year's motto and special activities. For the second time, he awarded the best scientific paper selected by an independent jury of scientists and technicians in the lighting domain. The prize was

awarded to DI Wolfgang Nemitz from Joanneum Research, Austria. The full article can be read in this issue of LpR on page 48. As a part of the opening ceremony, and a tribute to the International Year of Light, Prof. Joseph Niemela explained the aims and goals of the Year of Light initiative as well as future perspectives.

Design Meets Technology

The keynote session was a good introduction to the "Design Meets Technology" approach and with this in mind, it was only logical to invite a designer for one of the speeches. Zumtobel Group's Chief Design & Marketing Officer Rogier van der Heide talked about opportunities and emphasized that light does not mean much without darkness. He also used attention-getting statements like "Shift Happens" or "Design is the Drive to turn a Company into a Powerhouse of Innovation" and "We Need to Adopt New Skills". With his slides and his straightforward explanations, he made his position clear and earned a good amount of concordance. He argued that meanwhile creativity

in its various forms has become the number one engine of economic growth, and that recent products and experiences are increasingly defined by attributes that are less tangible and obvious to the user. Mr. van der Heide explained that a good amount of this creative power is based on software development and he asked what it could mean for lighting in this context. He came to the conclusion that new skills are required and data modeling, algorithm design, voice scripting, and gesture design need to become common design practices. For Mr. van der Heide it was also absolutely clear that "Lighting goes Digital". But he is also convinced that the design process will change: Tomorrow's designer must be prepared to help grow and adapt the product over time. Furthermore, he quoted Terence Conran who said, "Don't hire designers, be designers!"

The digital environment is the world of the second keynote speaker, Prof. Zary Segall. Before his talk, many people in the audience probably didn't have the slightest idea of what Semantic Lighting was

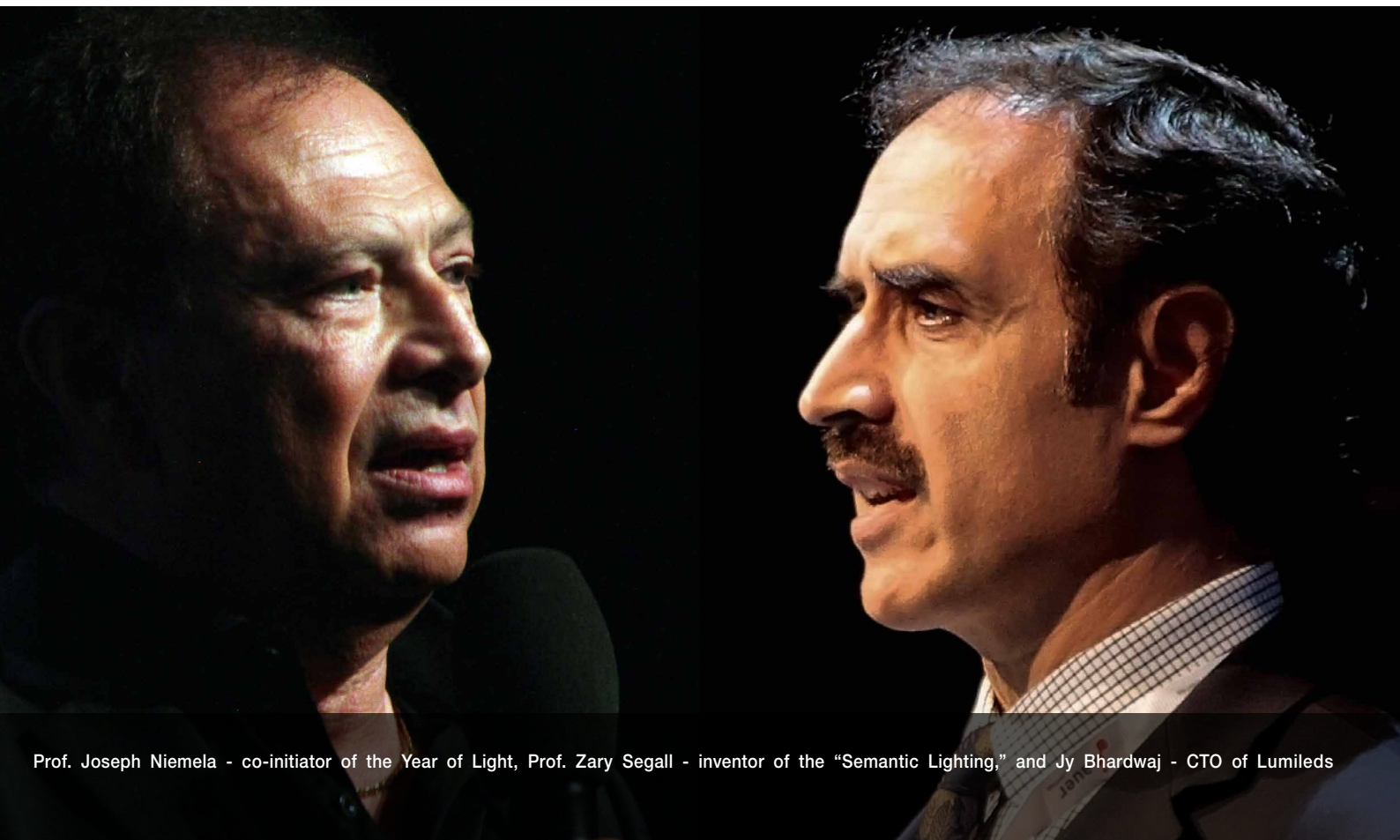

Prof. Joseph Niemela - co-initiator of the Year of Light, Prof. Zary Segall - inventor of the "Semantic Lighting," and Jy Bhardwaj - CTO of Lumileds

but by the end of the talk they had learned that what seemed so futuristic in the life of “The Jetsons” from the science fiction cartoon series aired in the 1960’s, just looks like a cheap copy of Prof. Segall’s vision and the already available possibilities of digital lighting. Smart digital lighting in combination with artificial intelligence can assist people in many situations of life today like, for example, a child’s toy shown in an Ikea application where the projected light reacts to human interaction with a toy train. The projection tells a different story dependent on the position of the train and the set action. In another example light can assist when preparing tea by telling the person when it is brewed and when it reaches the defined temperature. Semantic light can guide one through shops or provide relevant information. Some people might get the idea that it is a kind of “Big Brother” that assists us and may not feel comfortable with this idea. However, the opportunities are abounding and there are certainly applications where semantic lighting adds an incredible amount of value. Prof. Segall said, “Smart lighting all about you and your user experience, and Semantic Light user experience means that the physical and digital space is one, and light is the ‘glue.’”

The main topic on Day One was “Design Meets Technology”; meant to build a bridge between design, architecture and art on the one side, and technology on the other side

Adding value must be the goal of using technology, and technology needs to be adapted to maximize this value. Jy Bhardwaj, CTO of Lumileds, knows that very well and shared this knowledge when talking about “Trends and Challenges for System Integration”. Under his lead, Lumileds strengthened its profile in power LED manufacturing with some outstanding products that were developed by listening to the voice of the customer very carefully. He sees a transition of the business over time in three different levels; socket replacement, form factor innovation & connectivity and infrastructure integration of LEDs. While the second phase has just begun, the third very visionary phase is the most exciting and challenging. The current phase needs to carefully pave the way for a successful transition in phase three. Mr. Bhardwaj mentioned that he regrets that the industry missed chances in phase one to ease this transition by building up solid user confidence. Reliability as well as simplicity in applications are important issues that should be mentioned. In the current phase user confidence must be built up and he has several proposals on how to do it. One of the ways that Lumileds contributes to this challenge is by offering level 2 products that benefit from the knowledge from level 1 processes. He also misses a standard user

interface to simplify the control of the module and gives an example how it could look. Mr. Bhardwaj also explained that today’s lighting systems are missing the quality parameters that are common in non-lighting networks, like, for instance, resiliency or fault tolerance. He also presented a proposal for a solution to improve these weaknesses significantly. He concluded by saying, “The major remaining challenge is to develop standards for both network connectivity and for updating building codes. This must be tackled by the industry before we can step into the next phase: Infrastructure integration to create Embedded Lighting.”

Future LED Technology Is Driven by Application, Design, and User Aspects

The number of lectures alone that were classified as “Light Quality” or “Smart Controls” are a signal as to which direction the industry is evolving. The increasing number of topics such as connectivity and security support these trends and many topics in the “Light Sources” sessions also showed a strong relationship to the applications. Next to the top runner “Reliability & Lifetime” these were the sessions that were attended most frequently. The following is a brief summary:

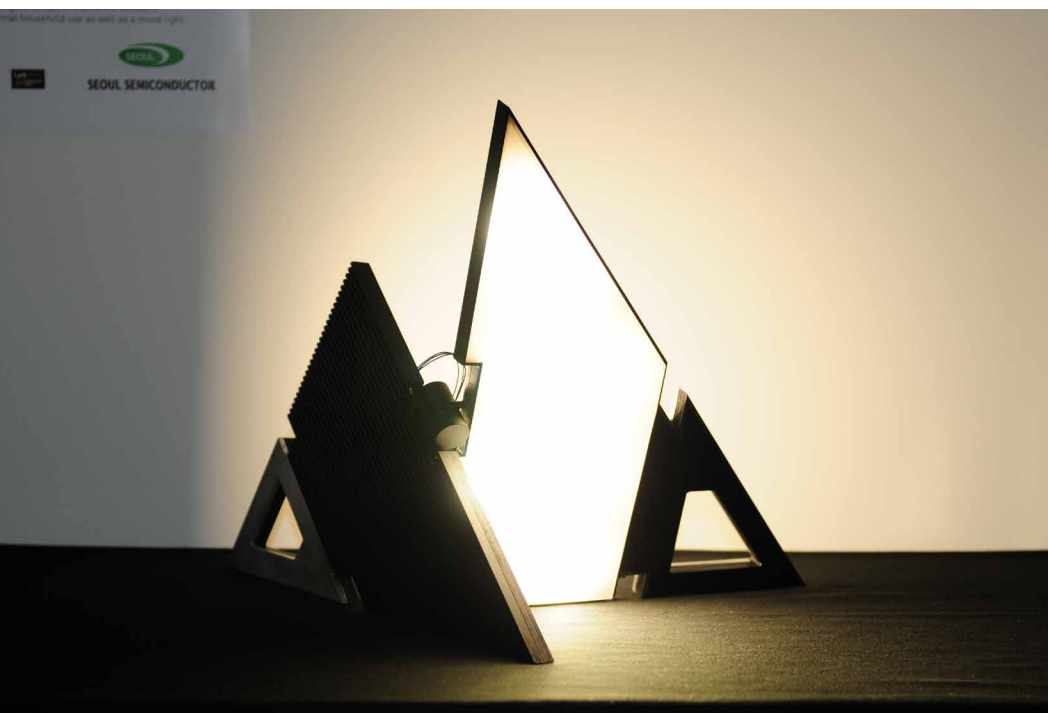



Inspiring talks by inspiring speakers characterized the LpS 2015 opening ceremony





Attendees of the highly specific lectures and workshops actively participated by asking questions and joining the discussions

Wojtek Cieplik from LED Engin showed how different the requirements in general human centric lighting, shop lighting and museum lighting are and therefore the designs need to be very different. Especially in system costs, smart sensory, simplicity and CRI there are remarkable differences that need to be taken into account. George Zissis from the Laplace University in Toulouse and his team investigated the quality of LED lamps for residential applications. The requirements for high quality lighting were defined by a group of specialists from 12 European countries, and also the declared specifications were compared with the measured data. The result shows that a lot has to be done because many products even failed to reach the declared specifications and even fewer products reached the defined quality criteria. Nicola Trivellin from LightCube developed and compared three different approaches for CCT and color tunable systems for human

The booths in the exhibition hall offered a place for specialists to continue their discussions



centric lighting. They identified a pc-converted lime with red and royal blue as the most efficient solution, a cool white plus warm white LED combination was the most cost effective solution, and the RGBW approach was recognized to be especially useful when a wide color gamut needs to be covered. In this context a smart approach based on one single channel power supply and two PWM signals to control brightness and color was proposed.

In the light source session, Daniel Doxsee from Nichia Chemical Europe explained how different phosphor blends can be used to generate the adequate light for different retail markets and help to improve visual merchandising. Josep Carreras from IREC talked about "Spectrally tunable SSL Solutions and Applications". He demonstrated the distinct differences in the requirements of horticulture, art lighting and human centric lighting. Research shows that a very carefully designed

spectrum has to be used for each of these applications for an optimized result. Prof. Günther Leising from the University Graz also emphasized the opportunities in human centric lighting.

In the domain of smart controls and drivers, Dr. Herbert Weiss presented the detailed findings from the EnLight project that has been covered already by a special feature in LpR 48. In this lecture he focused on energy savings. The lecture from Peter Niebert about distributed lighting control underlined the statements from the keynotes that software design is the topic of the future. While the demonstrated example is a piece of art, it can still show the capabilities of software based systems impressively. Two speakers focused on driver quality aspects. While Stefan Wegstein had a closer look at inrush current, voltage ripple and failure rates, Prof. Eberhard Waffenschmid showed the results of a study based on a survey of over 1400 LED





drivers. He demonstrated how diverse the specifications of LED drivers are compared to supplies for conventional light sources and that the chosen topology has great influence. Two speakers talked about digital driver solutions. Mikael Pettersson from SwitchTech gave an example how a two channel driver allows for the use of different controls opportunities that are recognized automatically; in this example, primary side push button switching, 0/1-10 V dimming, phase dimming, or external sensor switching. Due to the μC , limitless other control options can be implemented. He also demonstrated that the digital approach leads to a lower number of components used and hence to a more compact design. Ulrich vom Bauer from Infineon presented a digitally controlled flyback solution. Similar to Mr. Pettersson, he also demonstrated the controls flexibility, but also emphasized the opportunities to make such a solution robust against dimmer

and component tolerances in order to provide flicker free light at any dimming level down to 1% dimming level.

Final Tech Panel – Lessons Learned, Future Trends, and Industry's To-Do List

In the final Tech Panel session all attendees, speakers, and chairpersons were invited to summarize the impressions from the last two days. The high number of comments about the lecture and exhibition highlights showed how important the application view has become during the last few years. Not just related to a specific application, quality aspects seem to be the main issue. In addition, some technologies that had not been on the radar of many companies were identified and will probably be implemented in future products.

Heinz Seyringer from Zumtobel chaired two sessions about "Light Sources". He identified some of

these aforementioned technologies that were less well known as being potentially interesting and worthy of closer investigation. He said he could imagine that they could probably be implemented in the products of tomorrow; for instance Monocrystalline phosphors. He also found the rock-solid comparison between OLED and LED in respect to different applications presented by Pars Mukish very useful.

Advisory board member, Guenther Sejkora, chaired the sessions on "Measurement & Production" and "Light Quality". From the information from the latter he could see that technology has come to the level where light quality becomes the focal point of interest. This observation was immediately supported in the discussion and it was agreed that quality in respect to user experience is the most important issue with human centric light being the next stage of development.

LG Chem presented the world's largest, flexible OLED module (left); Automotive Lighting Workshop organised by the European Photonics Industry Consortium - EPIC (right)



Dr. Nisa Khan, President of IEM LED Lighting Technologies, also chaired two sessions. In the “Light Sources” she considered the light quality aspects like color rendering. She emphasized the importance of understanding that color rendering is a very relative parameter. Color rendering Index (CRI) has several challenges which have become especially visible with the introduction of LEDs. Dr. Khan promoted the TM30 improvement proposal for color rendering specifications from the IES committee. Upon request, she explained that light quality and color rendering had not been well defined by the industry before LED lighting became a topic. She sees a similar issue with the definition of HCL that should cover more aspects as it does currently, such as biophysical health issues. Furthermore, she recognized the glare factor as being an unsolved problem. As a new insight from one of the lectures, she mentioned PWM dimming effects that can go beyond flicker and are related to semiconductor properties, also negatively affecting well being and health. For the second session on “Measurement & Production” she pointed out the relevance of CIE 025 standard and the guidelines for how to interpret and measure correctly, for example, in regards to measurement tolerances or position dependent variations.

As “Building Blocks for Smart Lighting Designs” were a central issue of the conference and smart controls are an important part of that, Mr. Luger asked for opinions on this topic. Dr. Walter Werner, advisory board member with a lot of experience in this field, found it to be remarkable that there are now concepts evolving for controls every year despite the fact that controls have existed for many years now. The most relevant trend for him seemed to be modularity and the move of the borders between modules. As the classic approach he mentioned the split between lamp, driver inside the luminaire, and the controls placed somewhere

else. As a completely different concept, he named replacement bulbs having even the controls integrated. For him it is all on the move with a concept of new modularity for both inside and outside the luminaire that allows the connection of sensors that will be automatically integrated in the system. He found that a new software approach should be considered for eliminating any central control but allowing them to be interfaced. This concept for lighting had been presented by a computer and IT specialist. This was just one example that he felt underlined the trend that the major new influences are coming from other domains, namely IT and software development - catchphrase IoT. In this context, Dr. Werner expects the “Googles” and “IBMs” to be the drivers of innovation. In addition to this recent topic, he especially sees an old topic still being relevant - reliability. He emphasized that many components are not as reliable as they should be and that there is still a lot of homework to be done, like getting degradation or color shift under control. As a critical thought at the end of his explanations, he expressed his concerns that while new topics are joining the old topics, the lighting industry may not understand what story to tell and that other industries will be the ones who will tell the story in the end.

Coming back to the central theme of the LpS and the product that is the reason for this event, at the end of the final round, Mr. Luger gave the floor to Jy Bhardwaj. He concurred with Walter Werner when he expressed the thought that the new story is changing from energy by improved product efficiency to energy saving by switching off or dimming light. This is because many buildings are already equipped with very efficient systems so that no relevant additional energy saving can be achieved by simply changing the light source. He sees a big transformation potential and demand in home appliances but it did not really get started in volume

because it is currently still too expensive. Mr. Bhardwaj expressed his concerns about the answer of the industry to this situation. The current ongoing introduction of lower priced products with shorter lifetime in the US is one of the points he made. He argued that consumers are going for the cheaper product without taking care for the shorter lifetime, having the commonly propagated long lifetime in mind. This could lead to a bad name for LED lighting and the high-risk of dissatisfaction. He also started a discussion during the LpS where he was confronted with the belief that LED lighting could lower the earth's energy consumption. His opinion is two sided. Yes, LED lighting has a tremendous energy saving potential, but that is not the whole story. On the one hand, there are countries that have power and that are over-using energy with relatively inefficient lights, resulting in a certain savings potential. But people can start using light in many different ways, which could lead to them ultimately using more light. On the other hand, two thirds of the earth's population doesn't have enough light. These people will be needing a lot of light in the coming years. The cost points in that industry are very diverse. Furthermore, the distribution networks in these developing countries needs to be grown organically. The telecom industry plays a huge role here because they already have this network. They have the customers with the cell-phones, and they have already understood the cost point and billing methodology. They are beginning to install light as a service, integrating communication infrastructure used for billing the customer. This leads to the following question for the lighting industry: Are we working on the right problems to being solved? Design is just one aspect, but for most people on our planet there are more important issues. For Jy Bhardwaj it is therefore important that light becomes a part of the infrastructure. Coming back to what he said at the beginning, he stated that although using LEDs will save



Well attended lectures and exciting product demonstrations at the exhibition made the three days of the show a great success



energy, the overall energy consumption for lighting will increase. In the second part of his summary, Mr. Bhardwaj clarified the three levels of technical evolution that he already presented in his keynote speech. In the 1st stage the industry learned what LEDs are; how they work basically and possibly how to use them, mainly resulting in simple retrofit devices. In the 2nd phase, usage in much more creative ways is applied, resulting in new shapes with connectivity. Nicely engineered architectural luminaires are characteristic examples for this current phase. According to Mr. Bhardwaj, the challenge for the 3rd phase is that the current phase has to be completely understood before we can move on. But the many currently diverging standards are hindering this understanding. There are, for instance, many different types of high power LEDs with very different specifications on the market. But there are, in his opinion, additional standards that need to be established. These are

communication protocols. They are currently proprietary, and not coming to a common standard will slow down the development of the market. Therefore he pleads for a clear demarcation on the communication on control boards and light engines. This should lead to a common set of APIs so that everybody can communicate to it. This would enable developers to use any controls standard they want. While this is just the first step of the next phase, Mr. Bhardwaj also asked to foster confidence that SSL is reliable for 10-20 years or more, giving some proposals how that could be achieved from redundancy to building up maintenance cycles. Only if this infrastructure and thinking is completely in place the move in the 3rd phase can be successful. This 3rd phase is augmented with embedded lighting built into infrastructures without sockets - connected and automated. In his conclusion, Jy Bhardwaj again summed up the necessary requirements needed to reach that stage.

Conclusions

Besides sound technical information, the constructive critical remarks on the current situation in the industry and especially the inspiring, visionary contributions made the LpS 2015 outstanding. Several top class contributions like the keynote speeches as well as the fine-tuning of the orientation of the show were well received by exhibitors and attendees equally. The efforts made to be a topical event with modern up-to-date services and activities have been honored by almost a fifth of the exhibitors using the LpS as the platform to launch their products (see LpS 2015 Product Showcase on page 42). The whole lighting community hailed all the activities undertaken to bring technology and design together. This approach was recognized as another important step in the direction of an interesting and valuable future. ■



HONGLITRONIC Introduces High Performance AC LED Light Engines

High performance AC LED Light Engines; available power: 5 W, 10 W and 12 W; unique on board AC driver; direct AC 220-240 V input; up to 30% saving on BOM; very high Power Factor (PF > 0.95); low THD <20, high efficiency > 85%; EMC tested. Longer life than traditional driver based luminaires; no bulky traditional driver; easy assembly; In-built high temperature protection; available in non-dimmable and dimmable options; wide operating voltage range (200-265 V); In built surge protection.

For more details, please visit: en.honglitronic.com



sales@honglitronic.com

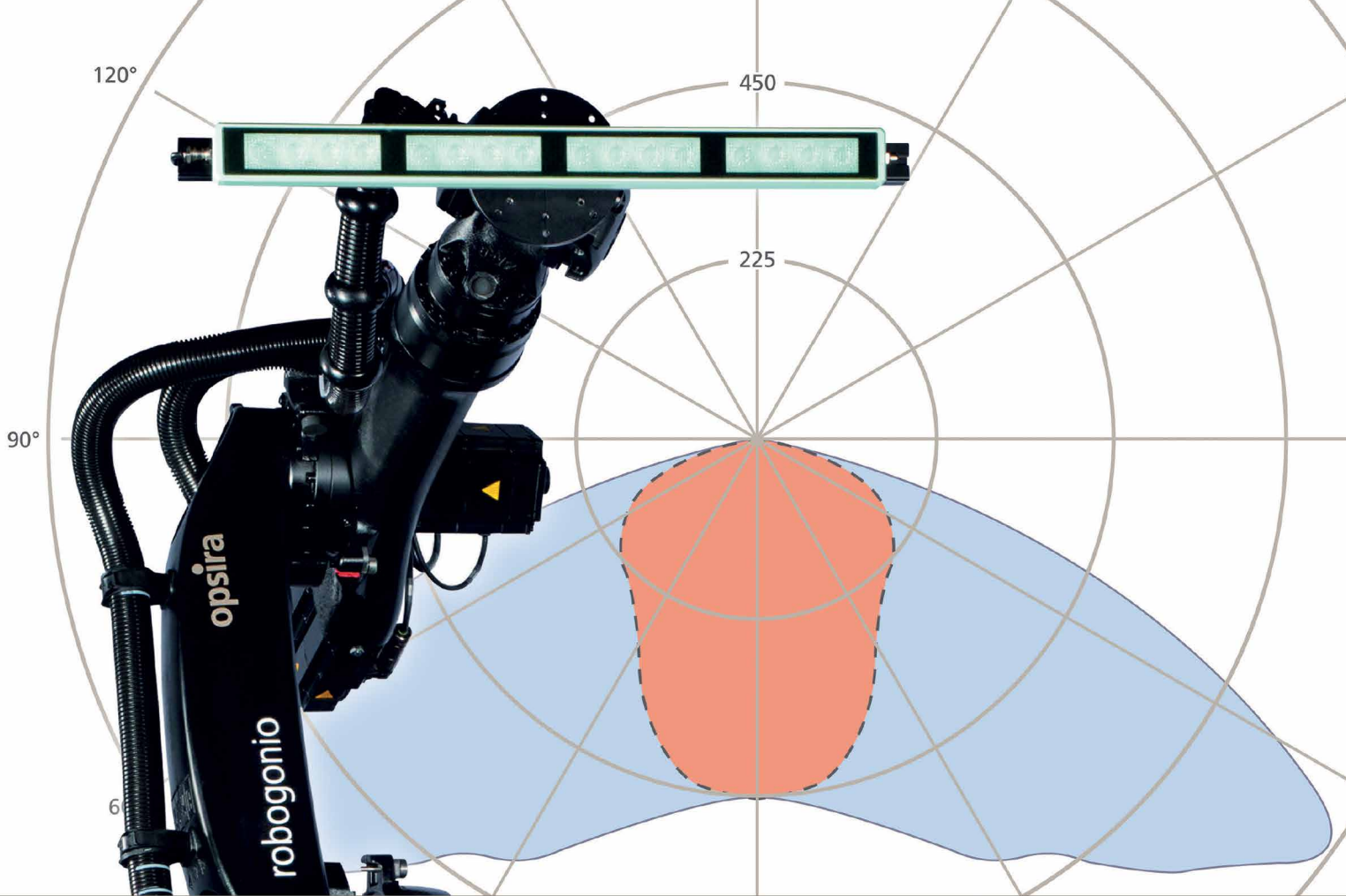

robogonio

The new world of goniophotometry

DIN EN 13032-4, EULUMDAT, IES – no problem for the robogonio. It enables goniophotometry in near and far field. Various detector systems. Hemisphere measurements within two minutes. Angle repeatabilities of 0.005° . Seven basic payload variants of up to 240 kg. Interested?

Enter the new world of goniophotometry: www.robogonio.com.



Quick. Precise. Highly flexible.
That's the robogonio.

opsira

www.opsira.com

LPS 2015 PRODUCT SHOWCASE – DOMINATED BY PRODUCT LAUNCHES

The exhibition area at the LpS 2015 increased significantly and with it the official and unofficial product launches. 18 companies officially launched 20 new products at the LpS press conference and several other companies also introduced new products at the event. Statistically speaking, this means that for every five companies in the exhibition hall, one launched a new product.

About the Product Launches at LpS

For a product to be accepted by Luger Research and benefit from the special product launch services it should not have been presented at another trade fair, at least not in Europe, before the LpS although it could have been mentioned in a press release up to two months before the event. Since 2014 Luger Research has been offering exhibitors that want to officially launch products at the show some special promotion offers. The impressive number of exhibitors that took advantage of the extended promotional offers this year shows how much it is appreciated.

Who Is Who and What Is New

The exhibitors with product launches were LED & OLED manufacturers, LED & OLED module manufacturers, electronics manufacturers, optics manufacturers, test equipment manufacturers and production equipment, raw materials or semi-finished products manufacturers. The products presented belong in the domains of light sources, electronics, optics and semi-finished optical products, testing equipment, thermal management, and manufacturing equipment and raw materials.

Light Sources

► This year **Lumileds** decided to exhibit with their own impressive booth and one week before the LpS they announced their new Luxeon Color C LED series. The new series is based on very different technologies, but they have a common identical focal length and low-dome design to prevent cross talk. The other relevant parameters were also adapted to be as identical as possible within the complete range of the Luxeon C series to simplify design and use. It is, for instance, possible to use the same lens type and size for any color.

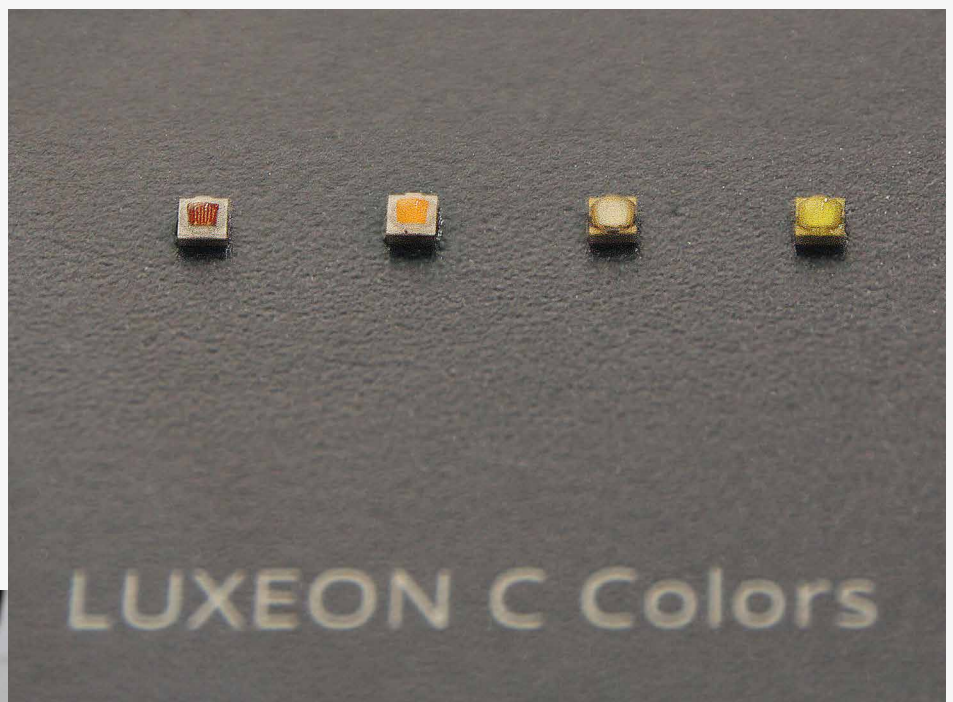

◄ **Cree** originally named their XLamp XHP35 for the product launch; a tiny SC5 technology based white HP LED that delivers up to 1883 lm. At the opening they surprised everyone by announcing that they had another new LED package with them that would be officially announced to the press during the event; the XLamp XQ-E High Intensity. With a new primary optics design, Cree reduces the “optical” source size by 50%. Cree furthermore claims also total compatibility between the different products within this series independent of color or epitaxy type.

► **Seoul Semiconductor** came with their WICOP2 LEDs (Y15 / Y19) to the press conference which had been announced just one week previously in Shanghai. This is basically a CSP LED, but compared to competing products again was reduced in design by eliminating the substrate. This leads to an even better thermal behavior. This improved solution was especially designed for general lighting applications and is based on SSC's experience in manufacturing similar LED types for backlighting units.

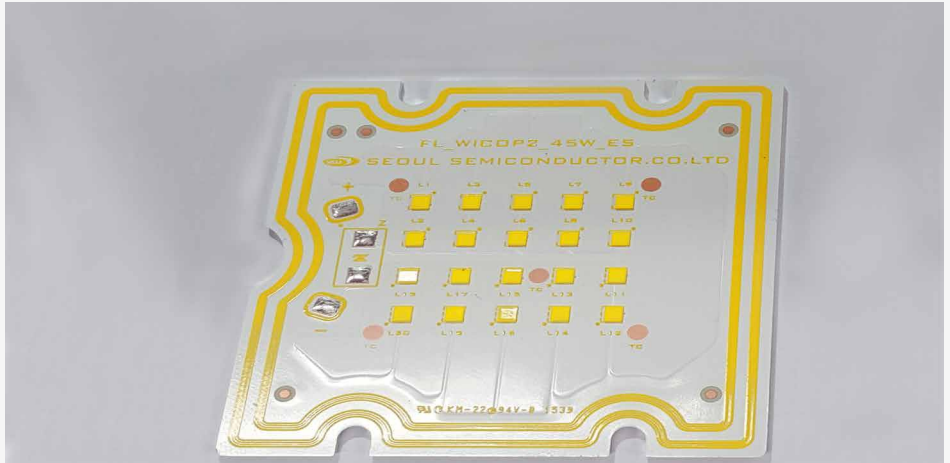

◀ **LG Chem** announced what is currently the largest flexible white OLED on the market. The new OLED has is 406 x 50 mm and emits 150 lm of white light according the preliminary data sheet.

► **Escatec**, a Swiss company situated not far from Bregenz, is probably better known for their high quality medical electronics. The company also has a lot of experience in bonding and packaging products including LEDs for special applications. Their unique new "Front-End/Back-End" solution for high power / high intensity applications is based on several novel technologies like a thermal substrate that surpasses the thermal conductivity of standard products by up to ten times. This allows the company to drive the LEDs much harder than specified, resulting in a much higher lumen output per chip area. Consequently, the optical properties are under better control and smaller lenses can be used.



Electronics

► **Code Mercenaries** teamed up with EDC and presented the prototype of a highly efficient 4-channel DALI LED driver with high current capabilities of up to 5 A. They only had a demonstration model at the show but promised to provide development boards very soon. In addition, they showed a wireless switch.

iLumTech presented their newly developed energy harvesting wireless sensor solution that combines a PV cell with a Bluetooth low energy interface. The light sensor transmits CCT and illuminance values and is, for example, intended for being built into furniture or a portable sensor for human centric lighting applications.

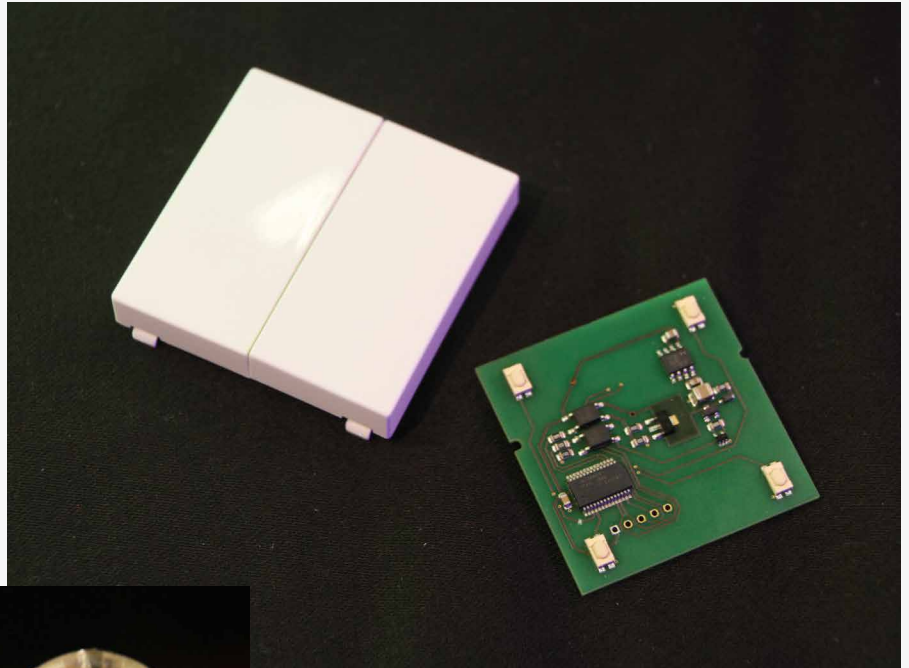

◀ **Marula LED's** product launch was a tiny IC for low voltage (12 V) replacement lamps of any kind. These replacement lamps usually face the issue that they don't satisfy the required minimum load of the electronic transformer for the original halogen lamps (right). And if they do, they are usually too bulky to keep the original form factor and often just dump energy. The tiny "slimdrive" MA1077 IC solves all these problems (left). It can be applied in combination with the LED driver already used without any redesign.

A fully digital driver solution with two channels that can be configured for a wide range of output voltages and currents was presented by **SwitchTech**. The really interesting feature is the flexibility of the controls interface. 0/1-10V, push button (SwitchDim) control or more sophisticated solutions like DALI or DMX are possible. Some options are available as standard and are automatically recognized, and some need to be ordered and will then be implemented by a software upgrade.

Optics and semi-finished optical products

► Lanyard sponsor, **Auer Lighting**, brought the first pre-production samples of their new hybrid optics that combines a lens and a reflector for glare-free light distribution with an accurately defined beam angle. The presented samples came from an early pre-production series and were not yet equipped with the SNAPIT® mounting features. The highly precise optics are traditionally made out of Auer's SUPRAX® glass.





◀ A newly designed optical grade silicone lens with very narrow beam angle down to 6° based upon LES was presented by **Gaggione**. The performance of this lens is based on the undercut internal concave cylinder shape design. This reduces stray light, and the micro structures contribute to a very homogeneous light distribution. Especially remarkable is that the design allows using a wide range of LES.

- ▶ **Evonik's PLEXIGLAS® WH** is a PMMA light guide sheet that includes the light extraction pattern optimized for homogeneity and efficiency, and a high performance light reflector layer. This semi-finished product with the combination of these three structures makes some costly manufacturing steps obsolete. Even complex shapes are possible with this product by thermo or vacuum forming processes.

Thermal management products

While being based on completely different materials and being used in very different stages of manufacturing, two products contribute to thermal management issues. In cooperation with **FineLine**, **Rusalox** presented their unique PCBs. These substrates produced by aluminum oxide technology consist of two main parts; conducting layers made of aluminum and/or copper and dielectric al-oxide material with a nano porous structure. This leads to much better performance compared to standard aluminum PCBs.

GigaPlast came to the LpS with a new enclosure for IP rated linear products. The products are made of extruded plastics that combine the optical structures with a thermally conductive part. This thermally conductive part provides a heat flow up to 10 times more effective than standard plastics.



Testing equipment

Gigahertz announced their new 1 m integrating sphere for the show.

The special feature of this new product is the flexibility. It can be easily turned in different positions to alter the orientation of the test device to accommodate measurement under different conditions. This is relevant as thermal behavior may be different and significantly influences light output, hence efficiency as well as lifetime.

GL Optic has added thermal controls capabilities to their GL TEC control system. This allows measurements to be taken under exact controlled temperatures as required by some standards such as CIE S 025/E:2015. The heat control is managed by GL Automation, a powerful tool which is part of the GL Specsoft software package.

Manufacturing equipment & raw materials

Dow Corning showed up with two new products for different components of the LED system. CI-2001 is a white reflective coating with a reflectance of 96% at 5-mil coating thickness that forms a robust, tough, resilient coating surface after curing. The second product, EI-1184, is a clear, two-part silicone encapsulation product with high transparency and robustness against weather and other environmental factors like extreme temperature cycles.

- ▶ Cost effective manufacturing of flexible LED sheets has been something that many luminaire manufacturers want for a while. **Mühlbauer's** new "Reel to Reel Flip Chip" assembly line means a big leap forward in this direction. The technology that is based on an adapted standard process, which has already been proven in Mühlbauer's RFID division saves up to 30% on the production costs.

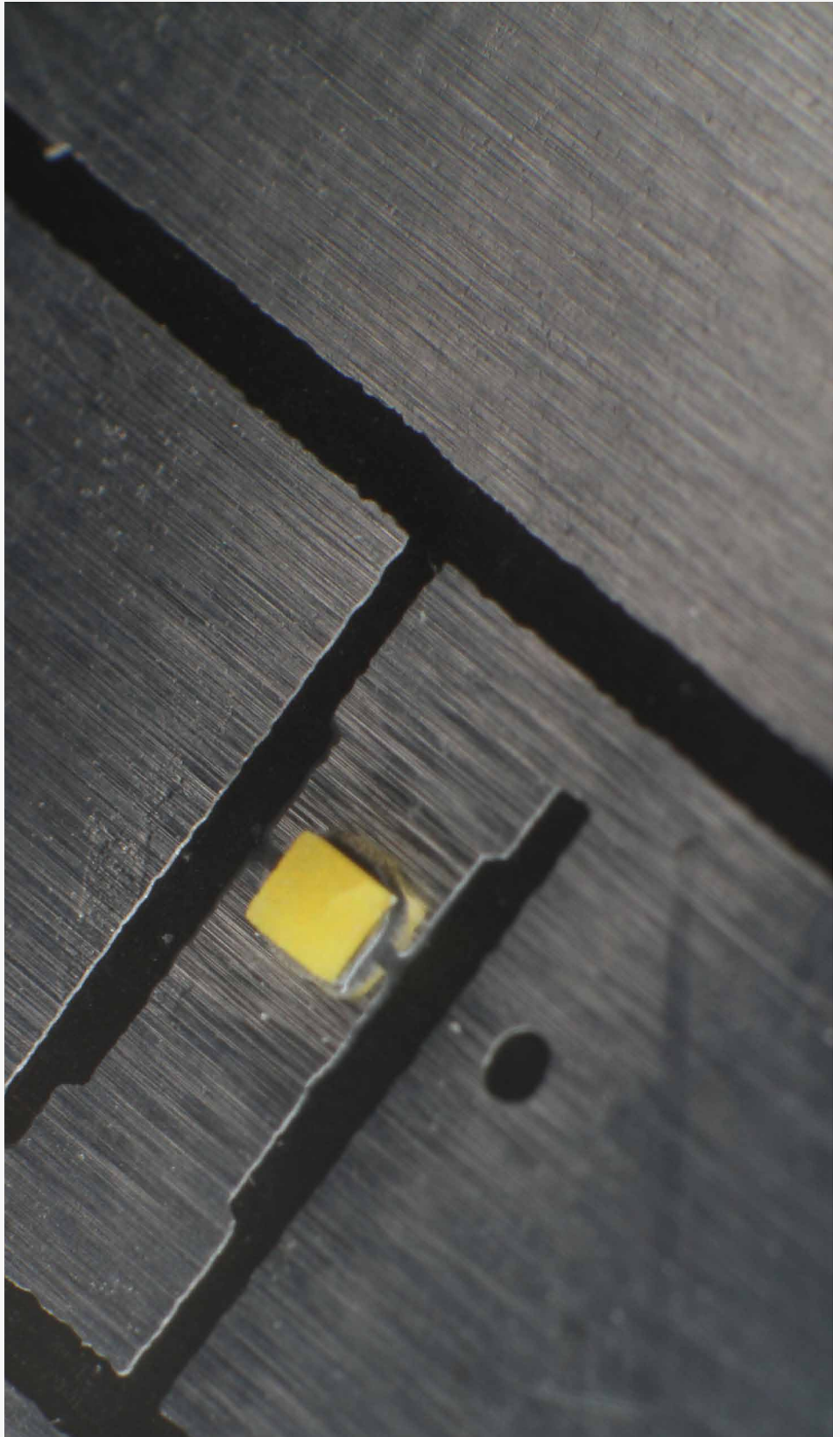

Summary

An impressive number of interesting new products that certainly will impact future product development were officially launched at the show. In addition, other innovative new products that were not included in the official product launch were shown at the show as well as recently improved versions of already well-established LEDs,

drivers or other components. The number of product launches demonstrate the value that the exhibitors put on the event and, on the other hand, they show that the innovative power and development in LED lighting is not fading away but is undeniably present. ■



瑞豐光電

2835

0.2W

0.5W

1W



Global Patent

Features

- Macadam / Energy Star standard, with high consistency;
- Optimized PPA and PCT material, with more resistant to high temperature and high reliability.
- Product specification close to the market mainstream
- LM-80 test approved
- IP free

Application

Fluorescent tube, bulb, candle light, ceiling light, grille light, down light, panel light, side light LED, high-efficiency tubes



Hong Kong International Lighting Fair (Autumn Edition)

NO: Hall of Aurora 1CON-24

2015.10.27-30 HKCEC

Features

- MacAdam Ellipse, keeping color consistency
- EMC with high temperature resistance and reliability, yellowing resistance
- QFN EMC packaging type, ultra-thin, ultra-small and user-friendly design
- Pass the LM-80 test

Application

Fluorescent tube, bulb, candle light, ceiling light, grille light, down light, panel light, side light LED, high-efficiency tubes

EMC3030



SHENZHEN REFOND OPTOELECTRONICS CO.,LTD.

Add: Building #1, 10th Industrial Zone, Tian Liao Community, Gong Ming Area, Guang Ming New District, SHENZHEN, CHINA
TEL: +86-755-66839118 FAX: +86-755-66839300 E-mail: konny@refond.com

Stock Code : 300241.SZ
www.refond.com



Iterative Optical and Thermal Simulation Method for Proper Simulation of PC LEDs

Designing phosphor converted white LEDs (PC LEDs) with stable behavior over time and with changing temperatures still remains a challenge. A reliable simulation to especially predict this behavior in regards to the temperature could help to find a solution faster that complies with the defined requirements. In his work DI Wolfgang Nemitz, scientist at Joanneum Research and his co-authors, Franz P. Wenzl, Susanne Schweitzer, Christian Sommer, and Paul Hartmann from Joanneum Research, and Paul Fulmek and Johann Nicolics from the TU Vienna, present an iterative method that addresses the above mentioned issues by combining optical and thermal simulations.

A common approach for white light generation relies on a combination of blue LED light and the excited emission from phosphor materials. The phosphor is part of the color conversion element (CCE), which typically consists of phosphor particles embedded in a silicone matrix. As shown previously, the chromaticity coordinates and also the white light quality critically depend on the composition and arrangement of such CCEs within the LED package. Moreover, the optical properties of the materials constituting the CCE and their temperature dependency, like the respective thermo-optic coefficients, have a huge impact on the constancy of the chromaticity coordinates. Phosphors generally face the problem of decreasing luminescence intensity with increasing temperature which is another important contribution of the constancy of the chromaticity coordinate values because the major thermal load of the LED package during operation occurs within the CCE.

We present a combined optical and thermal simulation procedure which allows us to model the thermal behaviour of phosphor converted LED packages with high accuracy. It relies on iterative optical and thermal simulations using ASAP (Breault), a ray-tracing tool, for the optical simulation parts and the open-source-software gsmsh/GetDP for the thermal simulations. This iterative combination of optical and thermal simulations allows to consider also the temperature dependency of the optical properties of the respective materials and is applied as long as the temperature distribution of the CCE does not change anymore, which is one possible stop criterion for the simulations procedure.

Our iterative optical and thermal simulation procedure enables the prediction of the thermal load and the variation of the chromaticity coordinates of PC LEDs during operation at different current levels. The simulations are verified by experimental characterization of LED packages fabricated in accordance with the simulation model.

Introduction

Even though the application of light-emitting diodes (LEDs) for lighting applications becomes more and more common, the potential of LED based lighting solution is still expandable. Besides criteria like efficacy, the quality of the white light is one the reasons why people hesitate to replace their traditional lighting sources with LED based luminaires [1]. In this regard, it has been suggested that the color variations among individual LEDs for general lighting utilization should stay inside a 2-step MacAdam ellipse [2]. That is really a challenge for the most common approach for white LEDs, which rely on the combination of blue LED light and the excited emission from one or more phosphor materials embedded in a silicone matrix. The composition and arrangement of these color conversion elements (CCEs) within the LED package have a huge impact of the quality of the white light and also of the overall light output of the white LED [3-4]. In addition, phosphors are prone to decreasing luminescence intensity with increasing temperature and therefore, it is absolutely essential to have a detailed knowledge of the

temperature distribution of the LED chip in order to trigger countermeasures with regard to the associated color temperature shifts. The primary blue light flux generated by common high-power LEDs, levels up to some 100 W/cm^2 which produces noteworthy heat fluxes. Another heat source is the heat generated by the Stokes shift within the CCE when the primary blue light is converted into the phosphor emission. Therefore, the ambition is to keep the temperatures of the LED chip and the CCE constant and as low as possible. For this purpose, different submount solutions have been analyzed for their thermal performance [5-6]. Besides these efforts, it is shown in recent studies, that the highest temperatures of phosphor converted white LEDs during operational may be located within the CCE [7-8]. Therefore, it is particularly necessary to have detailed knowledge about the temperature distribution within the CCE.

For the characterization of the thermal performance of high-power LEDs it is usually assumed that the active region of the LED (pn-junctions, multiple quantum well) is isothermal. One way to determine this effective junction temperature is using the LED forward voltage temperature dependency [9-10]. Unfortunately, the geometric design of the electrode pattern and the high power density lead to an expected inhomogeneous temperature distribution in the LED. This inhomogeneous temperature distribution itself affects the CCE where it heats up the phosphor particles and the silicone matrix.

An iterative method of combining optical and thermal simulations is presented that allows for getting accurate information of the temperature distribution within the LED and the CCE and therefore getting accurate information of the variation of the chromaticity coordinates of phosphor converted LEDs during operation at different current levels.

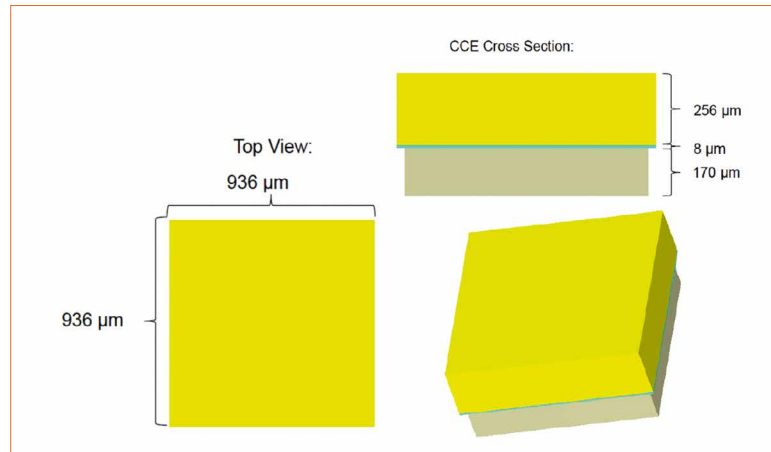

Optical Simulation

The details of the optical simulation procedure can be found in a previous publication [3]. Normally, it is based on the set-up of a suitable simulation model for a blue emitting LED die and the implementation of a CCE on the top of the die. The CCE is square-shaped with a flat surface and consists of orthosilicate based phosphor particles embedded in a silicone matrix (Figure 1- sketch of the simulation model). The optical simulations were performed with the commercial software package ASAP, which is a ray-tracing simulation tool.

The blue LED die has dimensions of $880 \times 880 \mu\text{m}^2$, whereas the dimension of the active layer is $850 \times 850 \mu\text{m}^2$. The height of the die is $170 \mu\text{m}$. The adhesive layer is modeled as a thin layer ($8 \mu\text{m}$) of pristine silicone with the dimensions of the CCE ($936 \times 936 \mu\text{m}^2$). It is directly placed on the top of the LED die. The CCE has a square-shaped geometry and is defined throughout this study by a width of $936 \mu\text{m}$ and a height of $256 \mu\text{m}$. It is directly placed on the top of the adhesive layer.

Two wavelengths are considered in the simulations, one representing

the blue LED light (460 nm) and the other one representing the converted yellow light (565 nm). It is assumed that only the blue LED light will be absorbed by the phosphor particles. Therefore the extinction coefficient of the phosphor is zero for the yellow light and 1×10^{-3} for the blue light. Both the blue LED light and the converted yellow light are scattered within the CCE based on the scattering model of Mie. The phosphor particles have a mean radius of $7.8 \mu\text{m}$ and a standard deviation of $4.2 \mu\text{m}$. The concentration of the phosphor particles within the silicone matrix is $11.5 \text{ vol.}\%$. The refractive index of the silicone (used for the CCE and also for the adhesive layer) and the phosphor is kept constant at 1.4 and 1.63 for both wavelengths at room temperature ($25 \text{ }^\circ\text{C}$). The thermo-optic coefficient of the silicone is assumed as

$$dn/dT = -5 \times 10^{-4} \text{ K}^{-1}$$

whereas the thermo-optic coefficient of the phosphor can be neglected with respect to that of the silicone. Both the adhesive layer and the CCE are constructed from small ashlar whose refractive indexes correspond to the temperature profile.

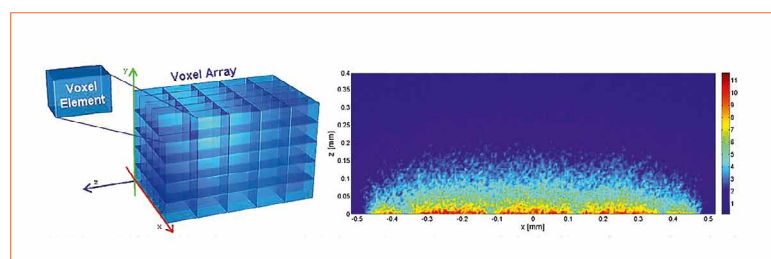

Figure 2: Left: Array of voxels (symbolic). Right: Cut in xz-direction of the absorption distribution within the CCE

Figure 1: The simulation model consists of a blue emitting LED die, a thin adhesive layer and a square-shaped CCE placed on the top of the die. The die has a height of $170 \mu\text{m}$ and a dimension of $880 \times 880 \mu\text{m}^2$, whereas the dimension of the active layer is $850 \times 850 \mu\text{m}^2$. The adhesive layer has a height of $8 \mu\text{m}$ and the same dimension as the CCE: $936 \times 936 \mu\text{m}^2$. The height of the CCE is $256 \mu\text{m}$

Figure 3: Left: Simulation model of the LED die with the reduction to six domains (reduction to one-eighth because of symmetry). Right: Simulation model of the combined LED package (i.e. LED die and CCE)

In order to get the absorption profile within the CCE, the CCE is divided into a number of voxels to determine the absolute number of the blue radiant flux that will be the transfer parameter for the thermal simulations (Figure 2 - simulated absorption distribution).

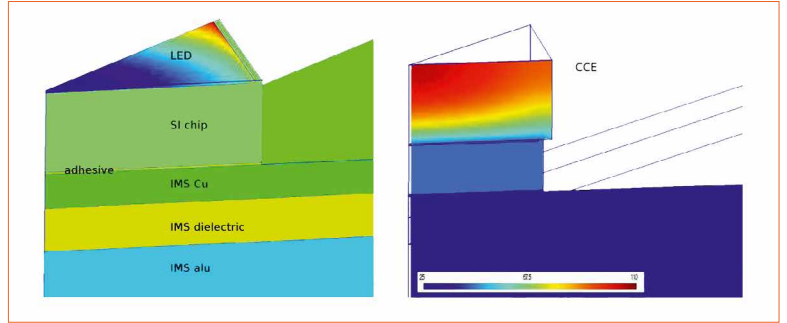

Figure 4: Measured temperature dependency of the luminescence intensity of the orthosilicate phosphor applied in this study

Thermal Simulation

As discussed in previous publications [11-12], the number (and position) of the absorbed flux of the blue LED light is taken as input parameter for the subsequent thermal simulations using the GPL-software packages GetDP/ Gmsh [13]. As the whole geometry of the model is symmetric with respect to four axes, the FEM calculation effort and time is reduced by simulating only one-eighth of the whole LED package. The model of the LED die is reduced to six domains, which are described by equivalent material properties (Figure 3 - sketch of the simulation model). The adhesive layer and the CCE are modeled as a block with a specific thermal conductivity and heat capacity.

The geometry used for the simulation model of the LED die is defined in table 1, whereas the materials parameters used for the simulations are listed in table 2.

For solving the FEM simulations, the following boundary conditions were introduced: The bottom surface of the LED die is assumed to be mounted on a perfect cooler, which has a constant temperature T_{cool} . For this study, this Dirichlet boundary condition has been

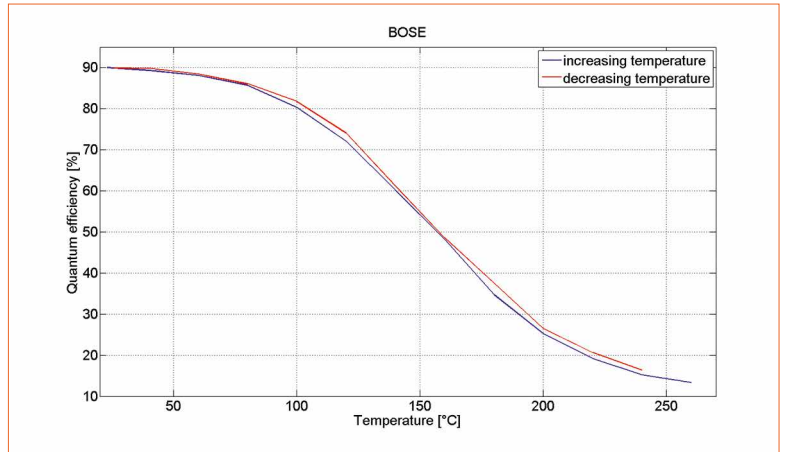

chosen as $T_{cool} = 300\text{ K}$. All other boundaries of the model are subject to natural convection in air, where at this work they are defined to $h = 20\text{ W/(m}^2\text{K)}$ and an ambient temperature of 300 K. The thermal conductivity of the CCE is in the order of 0.26 W/mK.

The heat sources for the thermal simulations are, on the one hand, the loss power of the LED die, which is determined by electro-thermal simulations, and on the other hand the contribution of the absorbed blue light. This contribution mainly consists of two types: First, the heat generation due to the Stoke's shift for those blue photons which are converted into yellow ones and second, the heat generation of

those blue photons which are absorbed but did not recombine non-radiatively. The latter case corresponds to a quantum efficiency smaller than unity. The temperature dependency of the luminescence intensity of the phosphor applied in this study is shown in figure 4.

The simulation procedure starts with an optical simulation that determines the absorption profile of the blue radiant flux within the CCE based on the optical parameters at room temperature. This absorption profile is used as an input parameter for the thermal simulations and the resulting temperature distribution within the CCE (Figure 5) again is used as input parameter for the subsequent optical simulation step.

Table 1 (left): Dimensions of the objects used for the thermal simulations

Object	xy-Dimension	z- Dimension
LED	850 μm	5 μm
Chip	880 μm	170 μm
Adhesive	880 μm	5 μm
IMS-Cu	5000 μm	70 μm
IMS-Dielectric	5000 μm	90 μm
IMS-Alu	5000 μm	2000 μm

Table 2 (right): Material parameters of the domains used in the simulations

Domain	Thermal conductivity W/(m·K)	Thermal capacity J/(kg·K)	Density kg/m ³
LED	45	327	5317
SI-Chip	100	703	2340
Adhesive	0.45	800	7000
IMS Cu	270	420	8300
IMS dielectric	2.6	900	3000
IMS Alu	138	897	2700

Iteration

In the previous sections we described the basic functions of the two simulation models and the generation of the transfer parameters. For the iteration procedure it is necessary to convert these transfer parameters into information which can be directly used in the simulation. For the optical simulation, that means that the temperature distribution will be converted into a distribution of refractive indexes of the silicone (in dependency of the local coordinates) and hence a new CCE consisting of a lot of small volumes, each of them considering the respective refractive indexes according to the thermo-optic coefficient will be generated. A colored version for demonstration can be found in figure 6.

For the thermal simulation, it is essential to generate thermal sources out of the absorption distribution considering the Stoke's shift on the one hand, and the temperature dependency of the materials parameters, like the luminescence intensity of the phosphor or the thermal conductivity of the CCE, on the other hand.

The iteration steps will be done successively until the temperature distribution of two following thermal simulations under-runs a defined threshold. The resulting temperature profile along the horizontal line of the LED package is shown in figure 7.

Experimental

For confirmation of the simulations, thermograms for a single Cree EZ900 Gen2 high-power LED chip on an IMS-submount, with a flat-shaped CCE positioned on top of the chip were generated using a high resolution IR thermography system: Infracore IR8300 with a sensitivity wavelength range of 3 – 5 μm . The chip was attached to a Peltier element to adjust the bottom temperature of the chip during the measurement. The geometry of the chip and the CCE corresponds

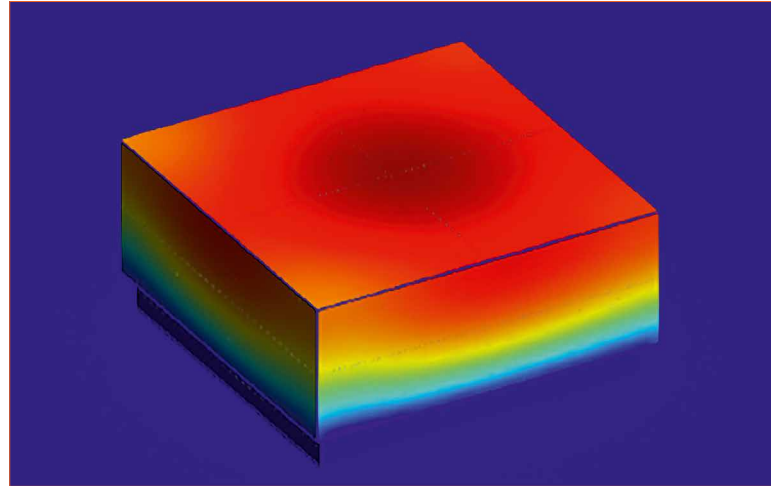

Figure 5: Simulated temperature distribution within the CCE as input parameter for the optical simulations

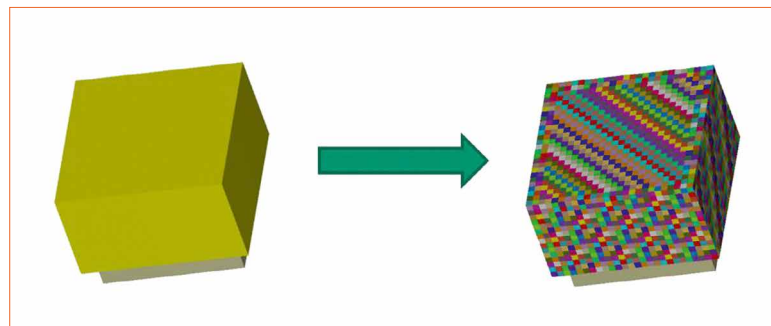

Figure 6: Demonstration of the CCE consisting of a lot of volumes, each with the same or different refractive indexes

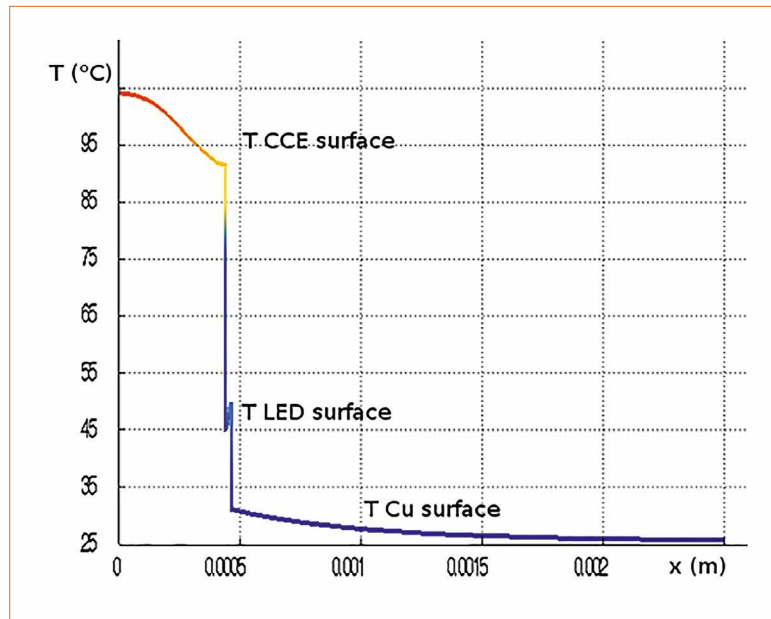

Figure 7: Result of the iterative optical and thermal simulations after fulfilling the stop criterion

exactly to the simulation model described in the previous paragraphs. For the measurements, it was necessary to assess an emissivity correction function for each sample. Therefore, the sample has been kept at two constant temperatures, 20°C and 40°C, and for each temperature thermograms have been taken. Fig. 8 shows the result of the emission-corrected thermography for the LED package at a forward current of 350 mA.

From the thermography images we extracted a temperature line-scan. The resulting temperature profile along the horizontal and vertical line is shown in figure 9. The dimension of the CCE where the temperature is in its maximum is as well observable as the IMS and the submount. The comparison with the simulation results shows quite good conformity.

Figure 8:
Steady-state temperature distribution at a forward current of 350 mA, measured by emission-corrected high-resolution IR-thermography with microscope lens

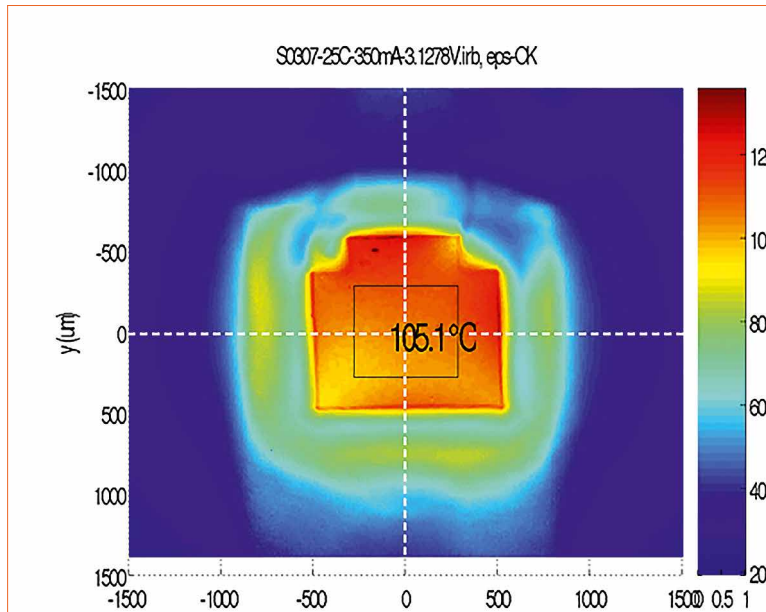
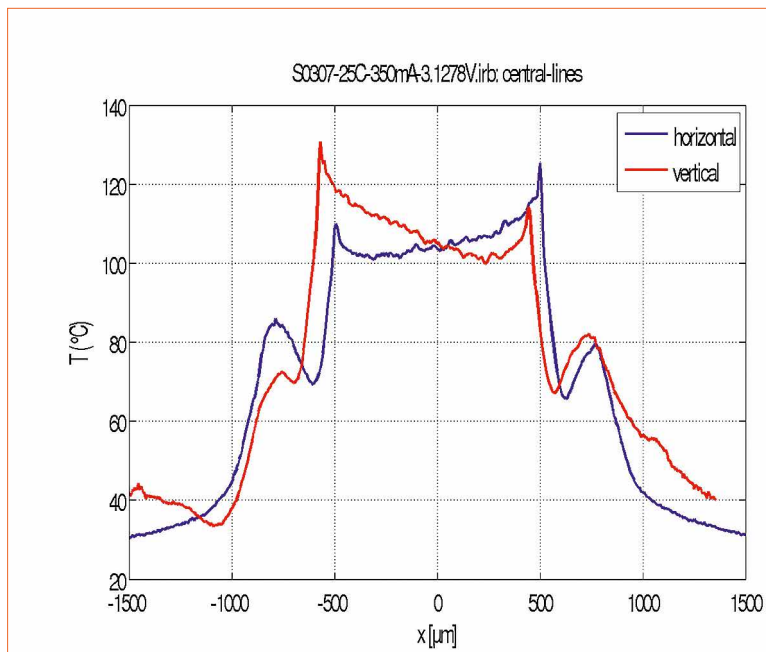

Figure 9:
Measurement of the temperature profile along the dashed horizontal and vertical lines of figure 8



Conclusions

We investigated a simulation procedure which consists of iteration steps of the combination of optical and thermal simulation and enables the prediction of the temperature of phosphor converted LEDs during operational at different current levels. The simulation results match the experimental measurements very good. The prediction of the exact temperature profile within the CCE and the knowledge of the temperature-depend behavior of the phosphors gives us the possibility to predict the thermal load of the CCEs and the variations of the chromaticity coordinates of phosphor converted LEDs during operational at different current levels. ■

Acknowledgement:

The authors gratefully acknowledge the financial support by the Klima- und Energiefonds (KLIEN) and the Österr. Forschungsförderungsgesellschaft mbH (FFG), project no. 843877, iCol.



NON-GLARE HYBRID OPTICS WITH DEFINED BEAM ANGLES BY AUER LIGHTING

Auer Lighting presents new hybrid glass optics **Jupiter**. It combines the benefits of a faceted reflector and a lens in one single piece. Auer Lighting's **Jupiter** fulfills the lighting designer's desire: no glare and defined beam angles.

See for yourself at **Light+Building 2016, Frankfurt, Hall 4.1, Stand J10**



www.auer-lighting.com/led

References:

- [1] J. Brodrick, Solid State Lighting: "Technology at a turning point"; http://apps1.eere.energy.gov/buildings/publications/pdfs/ssl/feb2013_nema_brod
- [2] N. Narendran, L. Deng, R. M. Pysar, Y. Gu, and H. Yu, "Performance characteristics of high-power light-emitting diodes"; Proc. of SPIE vol. 5187, 267, (2004)
- [3] C. Sommer, P. Hartmann, P. Pachler, M. Schweighart, S. Tasch, G. Leising, F. P. Wenzl: "A detailed study on the requirements for angular homogeneity of phosphor converted high power white LED light sources"; Opt. Mater. 31, 2009, 837 – 848
- [4] C.-C. Sun, C.-Y. Chen, C.-C. Chen, C.-Y. Chiu, Y.-N. Peng, Y.-H. Wang, T.-H. Yang, T.-Y. Chung, C.-Y. Chung, "High uniformity in angular correlated-color-temperature distribution of white LEDs from 2800K to 6500K"; Opt. Express 20, 2012, 6622 – 6630
- [5] M. Unger, J. Nicolics, G. Langer, F.P. Wenzl, W. Nemitz, P. Fulmek, S. Schweitzer: "Thermal Performance Study of Direct Attached High-Power LEDs using an Innovative Submount Technique"; Proc. of the 2014 Electronics System-Integration Technology Conference, September 16-18, Finlandia Hall, Helsinki, Finland 2014, pp. 171-176.
- [6] G. Langer, M. Leitgeb, J. Nicolics, M. Unger, H. Hoschopf, F.P. Wenzl: "Advanced Thermal Management Solutions on PCBs for High Power Applications"; IPC APEX EXPO 2014, March 25-27, 2014, Las Vegas, USA.
- [7] M. Arik, S. Weaver, C. Becker, M. Hsing, A. Srivastava: Proc. ASME/IEEE Int. Electronic Packaging Technical Conf. and Exhibition (InterPACK'03), Maui, HI, Jul. 6–11 2003.
- [8] X. B. Luo, R. Hu, J. Int., Heat Mass Transf. 75 (2014) 213.
- [9] Y. Xi, E. F. Schubert: "Junction-temperature measurement in GaN ultraviolet light-emitting diodes using diode forward voltage method"; Appl. Phys. Lett. 85, 2004, pp. 2163-2165.
- [10] P. Fulmek, G. Langer, F.P. Wenzl, W. Nemitz, S. Schweitzer, H. Hoschopf, J. Nicolics: "Direct Junction Temperature Measurement in High-Power LEDs"; IEEE Proc. of 37th Int. Spring Seminar on Electronics Technology, Dresden, May 7-11, 2014, pp. 58-63.
- [11] P. Fulmek, C. Sommer, P. Hartmann, P. Pachler, H. Hoschopf, G. Langer, J. Nicolics, F.P. Wenzl, Adv. Opt. Mater. 1 (2013) 753.
- [12] F.P. Wenzl, C. Sommer, P. Hartmann, P. Pachler, H. Hoschopf, G. Langer, P. Fulmek, J. Nicolics, Opt. Express 21 (2013) A439.
- [13] C. Geuzaine, J.-F. Remacle: Gmsh: "A three-dimensional finite element mesh generator"; 2015, <http://geuz.org/gmsh>. P. Dular, C. Geuzaine: GetDP: a General Environment for the Treatment of Discrete Problems, 2015, <http://geuz.org/getdp>.

2835,1200,000,000 pcs Per Month

0.1W-2W (PPA-PCT-EMC) SMD LED



2835 160lm/W

Luminous efficacy up to 160lm/W (@60mA)
Low thermal resistance 19°C/W(TC: 6000K, Ra: 80)
Capacity 1200KK pcs per month
Super high price-performance



5730



5060



4014

Our wide rang of White light LEDs for lighting applications have 2835, 5730, 3014 4014, 3528 3030, 5060, low and mid power LEDs. LM-80 Certified, High Luminous efficacy, Full power coverage 0.1W-2W (PPA-PCT-EMC), meet all Kinds of Lighting Applications: tube light, panel light, down light, led bulb, PAR light etc. Super high price-performance!



HONGLITRONIC
鸿利光电
Stock Code:300219



Guangzhou Hongli Opto-Electronic Co., Ltd

Tel: +86-20-8673 3333 ext 3033
Fax: +86-20-8673 3883
E-mail: sales@honglitrionic.com
www.honglitrionic.com



Official website

230 VAC Driven LED Modules with Strongly Reduced Flicker

One of the continuing trends in LED lighting is toward AC driven LED modules. Big progress has been made regarding dimmability and reduction of flicker. However, there are still differences in the various concepts that lead to very different results. Wolfgang Endrich, founder and managing director of euroLighting presents a recently improved new concept to significantly reduce flicker.

The US Ministry of Energy (DOE) has forecasted in their annual F&E plan regarding solid state lighting 2015 that by 2030 about 80% of all luminaires in the United States will be operating with LED. This would create a reduction of about 60% in the consumption of electricity. Even the losses by the LED driver could add up to 10% or more and the failure rate of the LED driver is up to 52% for Asian products. Therefore the US Ministry of Energy recommends the usage of AC-LED driver technology and called it the “coming next generation of light sources”.

Designing a new LED luminaire poses great challenges today – including selecting the right LEDs and a suitable power supply unit. The new AC technology has now substantially simplified this process: It allows direct control of the LEDs with 230 V AC and generates virtually flicker-free light with very good dimming properties.

Having to develop a dedicated power supply unit can significantly delay a new project. It is much easier now to use the new AC technology with direct control through 230 V AC – with obvious advantages: In addition to considerable cost reductions, LEDs from different manufacturers can be used and combined in one circuit. It is now possible to use a much smaller power supply unit which can be integrated unobtrusively into any housing and can be included already on the PCB of the LED.

Direct Control with 230 V

Directly controlling an LED with 230 VAC may sound puzzling especially with regard to the so-called safety measures and insulation can quickly dispel these doubts. The newly designed IC, the IC EL01, allows LED driver circuits to be operated directly with 230 VAC while generating almost flicker-free light. The 230 V mains AC power is rectified and fed into an AC direct driver without smoothing.

The driver pulses with 100 – 120 Hz and operates the LEDs with constant current and a voltage between 40 – 70 VDC. This produces the advantage that LEDs from different manufacturers specified for voltages between 2 and 70 V can be controlled directly. With an operating voltage of 70 V, numerous DC LEDs with different voltages (max. 70 V) can be directly operated in a group. So if an LED has an operating voltage of, for example, 2 V, up to 35 LEDs of this type can be connected in series. The circuit and the required power input can easily be expanded through the use of further ICs.

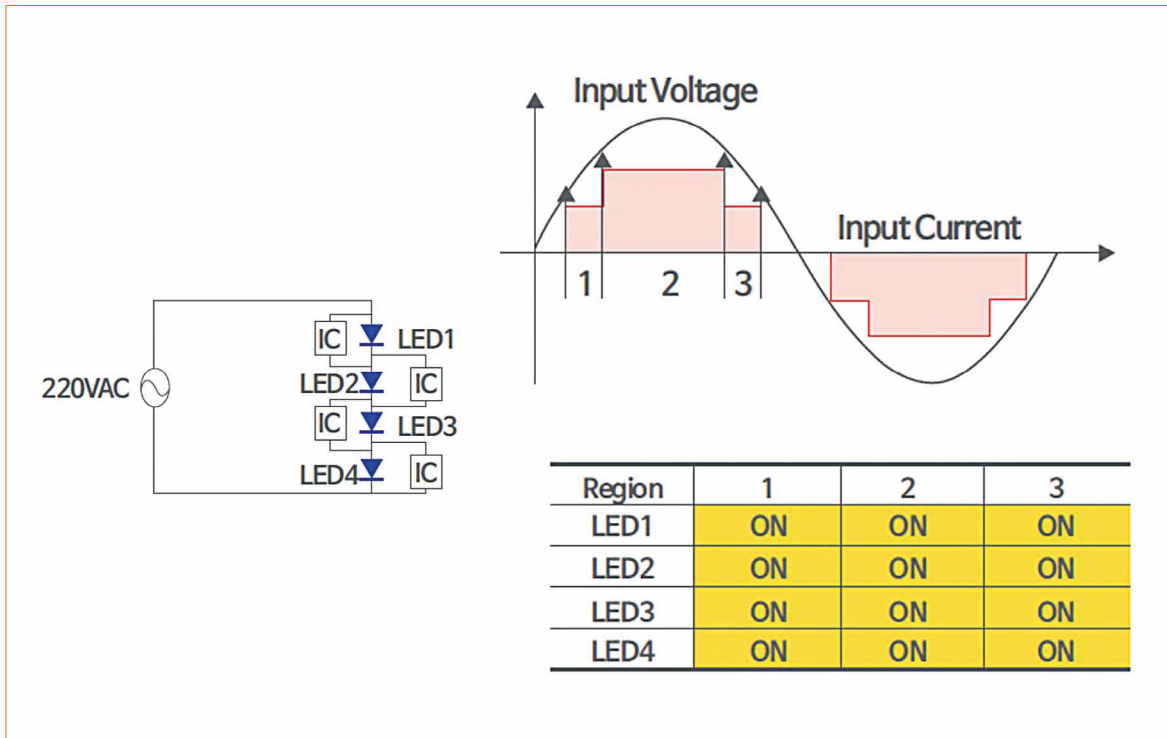
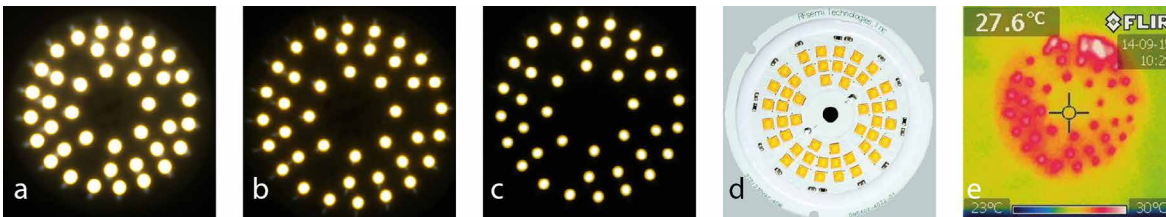

Figure 1:
AC driving mode with
the new designed IC



Figures 2 a-e:
The EL01 LED modules
dimmed to 5 W (a),
dimmed to 2 W (b),
dimmed to 1 W (c),
chips are mounted all
around the edge (d),
leading to an even
thermal distribution (e).
Many other AC
concepts use a
sequential dimming
concept with just one
central IC

Different Dimming Concepts

In Germany and in Asian countries, numerous products have already been equipped with AC technology for many years. It has proven successful, e.g. in retrofit lamps, GU10, ceiling spotlights, ceiling floodlights up to 120 W, area luminaires with 62 x 62 cm and LED tubes. The market also offers numerous ICs that can be used to implement AC direct circuits. They have one significant difference, though: These circuits can generally be dimmed, but in two ways.

New concept using multiple new designed ICs

The new IC and the circuit created with it, allows simultaneous dimming of the entire luminaire. That means all LEDs are dimmed evenly (Figures 2a-e).

Figures 2 show that the EL01 LED modules can easily be dimmed without changing the luminous flux

modulation - Luminous flux modulation dimmed to 5 W (a), dimmed to 2 W (b), dimmed to 1 W (c), EL01 Chips are mounted all around the edge (d), leading to an even thermal distribution (e).

Reference concept using one IC for sequential dimming

The most common approach is to implement sequential dimming of individual assemblies. This involves supplying individual groups with full power and adding more groups if more brightness is required. This has certain disadvantages: Not all LEDs can be dimmed at the same time so that the thermal load varies and is not distributed evenly across the entire area. The circuit created with this system uses only one central IC.

The dimming of a conventional AC driven LED module using the sequential dimming approach for example dimmed to 6 W results in a

luminous flux modulation of approx. 9 ms with some LEDs being already less bright. Dimmed to 4 W, some LEDs are completely off. The placement of the IC and such a concept can also result also in an uneven heat dissipation, where hot spots can appear.

The new concept uses several ICs which ensures an even thermal load. This makes a useful life of 50,000 h absolutely realistic. Furthermore, this IC features an NTC characteristic which reduces the full power from 85° C to prevent overheating. Long-term tests with these components of over 30,000 hours have shown many advantages: A greatly simplified circuit without electrolytic capacitors and inductivities or transformers. The useful life of the circuit corresponds to that of LEDs with > 50,000 hours, uniform dimmability of the circuit without additional circuitry components as well as flicker-free light at all power levels.

About Flicker-Free AC Lighting

Questions about flicker-free light, especially AC light, and how to measure and to specify it, may arise at this point. To be fair, it should be pointed out that fluorescent tubes operated with conventional or low loss magnetic ballasts also flicker at 100 Hz and the light output is reduced at lower ambient temperatures. Fluorescent lamps operated with an ECG, including energy saving lamps work at 40 – 50 kHz so that the lamps normally do not flicker visibly.

In reality, however, things are a little bit different. While a higher switching frequency is used, the input capacitors are often too small for cost reasons. This causes the high frequency circuit in the lamp to be supplied with a strongly pulsating voltage. This pulsation creates a brightness modulation in the emitted light, which is why these lamps often have a rather high level of flicker at 100 Hz.

As already mentioned, all conventional light sources - including incandescent, high intensity discharge (HID) and fluorescent – modulate luminous flux and intensity, whether perceptible or not. Many terms are used when referring to this time-variation, including flicker, flutter and shimmer. The flicker produced by electric light sources can be a function of how it converts AC electricity to light. It can also be the result of noise of transient events on AC distribution lines.

Electrical flicker should not be confused with photometric flicker, which is the characteristic modulation of the light source caused by electrical input rather than disturbances. Light source characteristics that can affect photometric flicker vary by technology. For LEDs, flicker characteristics are primarily a function of the LED driver.

Photometric flicker from magnetically-ballasted fluorescent, metal halide and high pressure

sodium lamps has been a concern of the lighting community because of its potential human impact which range from distraction or mild annoyance to neurological problems. The effects of flicker are dependent on the light modulation characteristics of the given source, the ambient light conditions, the sensitivity of the individuals using the space, and the tasks performed. Low-frequency flicker can induce seizures in people with photosensitive epilepsy, and the flicker in magnetically-ballasted fluorescent lamps used for office lighting has been linked to headaches, fatigue, blurred vision, eyestrain, and reduced visual task performance for certain populations. Flicker can also produce hazardous phantom array effects.

Back to the AC circuits: 100% flicker-free light only comes from the sun: Even traditional filament light bulbs just offer and nearly flicker-free light. However, there are considerable differences between the chip solutions of the compared concepts.

Flicker fusion threshold

When evaluating temporal uniformity as a quality criterion for lighting, fast and slow changes have to be considered separately. Fast changes are the temporal fluctuation of luminous flux of the emitted light due to the pulsating fluctuations of the input, e.g. with AC operation. A crucial factor for whether this fluctuation is perceived as irritating is the flicker fusion threshold of the eye, which also depends on individual circumstances. If the frequency of the luminous flux modulation is above this fusion threshold we can no longer perceive it. This limit frequency, where periodically occurring stimuli are just starting to be perceived as a stimulus, is called flicker fusion threshold and is below 100 Hz for most individuals while a good part - I believe over 50% - of the people don't even recognize flicker above 70 Hz. Therefore, the relevant flicker frequency for many applications is

recognized to be approximately around these 70 Hz. It is also referred to as pulsation. Below this fusion threshold, however, the luminous flux modulation is perceived as an irritating flicker. Eyes are particularly sensitive to this in peripheral vision. Fast moving objects (e.g. lathes) can additionally create stroboscopic effects with the resulting phantom array effect.

Relatively slow changes (in the domain of seconds to minutes) in illumination can have a rather positive influence on the human state of mind. The variability of lighting through artificial indoor lighting systems is only slowly gaining significance as a quality aspect. Monotonous constant lighting creates a tiring effect in the long term and has no positive influence on concentration and efficiency.

There is DC and (DC + AC) light. The following formula applies for dimming LEDs with the usual pulse width modulation (PWM), which is typically a (DC + AC) light:

$$W = (\phi_{max} - \phi_{min}) / \phi_{mean_WLED} = \text{within } \leq 1 \text{ } W < \infty$$

Disadvantage:

This creates a considerable luminous flux modulation (Figure 3).

Criteria for good flicker-free light

Two criteria are important for good lighting: The clock frequency of the LEDs has to be well above the flicker fusion threshold. The direct AC control for concept 1 as described has a frequency of 100 Hz. Furthermore, the light intensity should be as uniform as possible. That means rectangular light intensities create a balanced light while wedge-shaped light peaks are perceived as irritating. (Figures 4 a + b).

Figures 4 a & b demonstrate the light fluctuations of different AC driven LED modules. EL01 LED module from euroLighting:

trapezoidal light curve (a), LED module from a different manufacturer: wedge-shaped light peaks (b); (luminous flux modulation is measured with an ultrafast photodiode. Normal operation and dimmed).

Quantifying Flicker

After all considerations about the theory we will explain in the following how to measure the flicker. A very interesting report was issued by the "US Department of Energy – Energy Efficiency & Renewable Energy". The following explanations will refer to this report and the direct fact sheet [1].

The following will refer on the basis of this "fact sheet":

The percentage of flicker at the modulation index and the flicker index. But the result will be the realization that there is not a good or a bad flicker. It really depends on the application whether it is indoor or outdoor usage and finally the human being.

Low flicker sources should always be used for both ambient lighting and task lighting in offices, classrooms, laboratories, corridors, and industrial spaces. Minimizing flicker is especially important where susceptible populations spend considerable time such as hospitals, clinics, medical offices, classrooms, and daycare centers. In contrast, flicker may be less of a concern for parking lots, roadways, or other exterior lighting where light levels are lower and people spend less time.

In the above mentioned report of the US Department of Energy show a very good example to explain what we are talking about now.

How to Measure Flicker

Three analysis methods are suitable and relevant for the calculation of photometrical flicker, which may not be mixed up with voltage or current flickering in electric circuits. These are the flicker index and

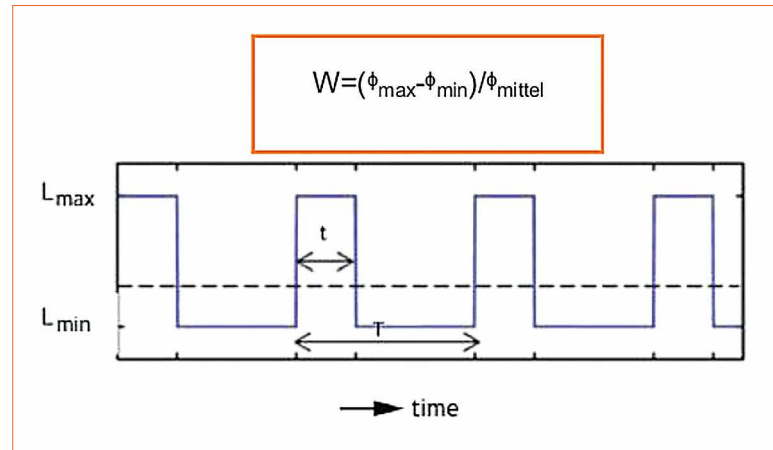
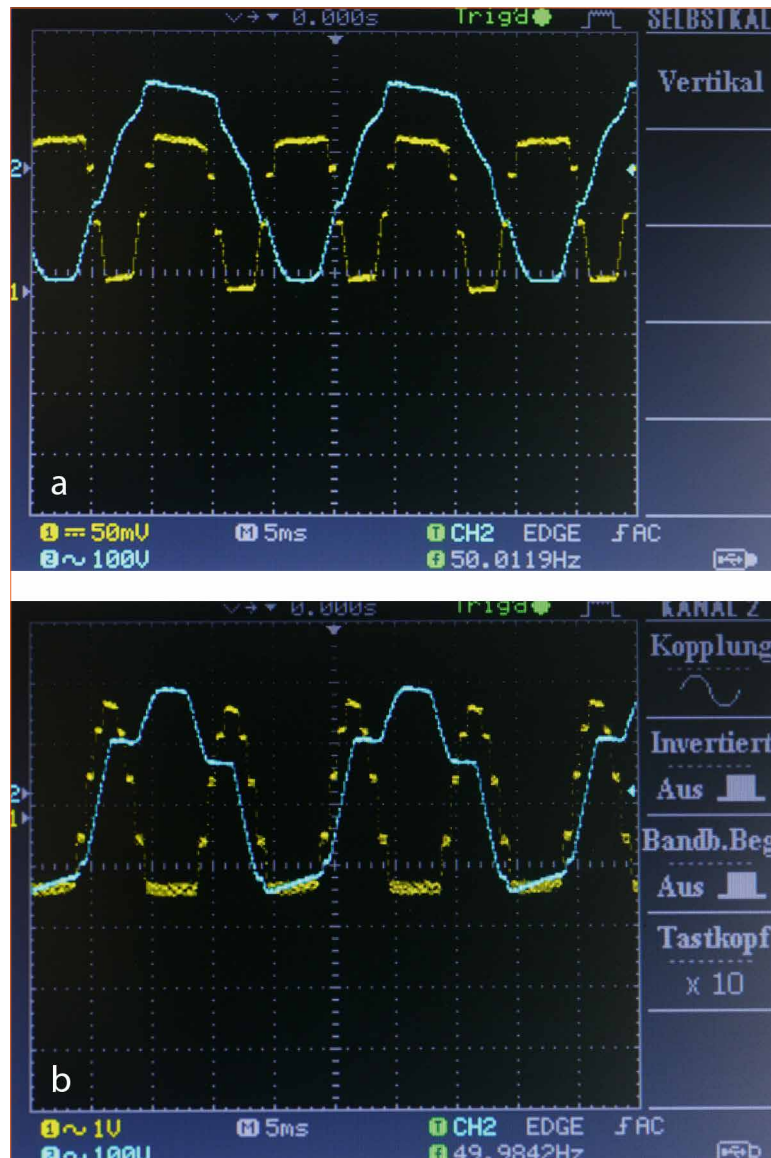

Figure 3:
Flux modulation in a PWM system



percent flicker, and less common the modulation index. All three methods have in common that they are relative measures. The flicker index takes into account the waveform of the light output as well as its amplitude according to the handbook. The flicker index

assumes values from 0 to 1.0, with 0 for steady light output. Higher values indicate an increased possibility of noticeable lamp flicker, as well as stroboscopic effect. Percent flicker and the flicker index are used to compare the new technology with a conventional AC module.

Figure 5: Periodic wave form characteristics used in the calculation of flicker metrics (modified from IES Lighting Handbook, 10th Edition)

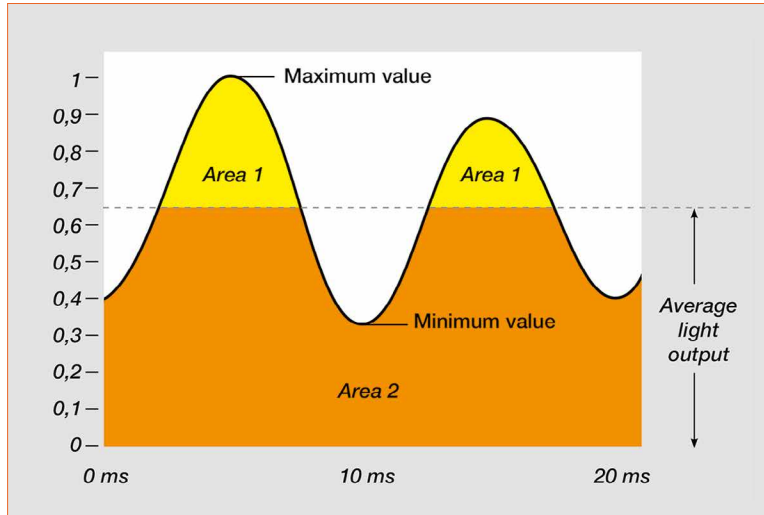

Flicker indices and flicker percentages of the examples from figures 6 a + b:

Flicker Index for Figure 6 a

$$F_i = \text{Area 1} / (\text{Area 1} + \text{Area 2}) = 9 / (9 + 19) = 0,32$$

Percentage of Flicker for Figure 6 a

$$F_{\%} = (\text{Max} - \text{Min}) / (\text{Max} + \text{Min}) \times 100\% = (2,3 - 0,5) / (2,3 + 0,5) \times 100\% = 64,3 \%$$

Flicker Index for Figure 6 b

$$F_i = \text{Area 1} / (\text{Area 1} + \text{Area 2}) = 1 / (1 + 3) = 0,25$$

Percentage of Flicker for Figure 6b

$$F_{\%} = (\text{Max} - \text{Min}) / (\text{Max} + \text{Min}) \times 100\% = (2,4 - 0,3) / (2,4 + 0,3) \times 100\% = 77,8 \%$$

Figures 6 a&b: Two trapezoid light output waveforms and the related flicker parameters as flicker index and flicker %

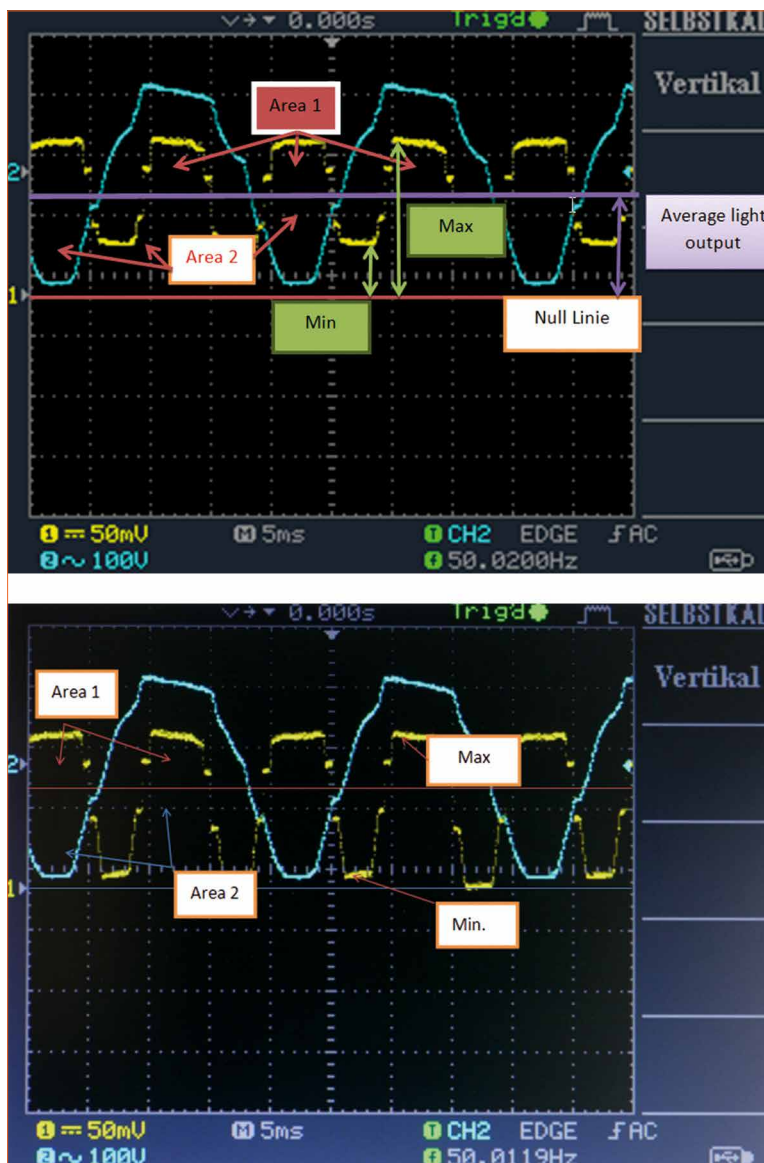

A comparison of the measurement diagrams in figures 6 a & b and figure 7 show the distinct different shapes of the light output waveforms (yellow lines). While the waveforms in the figures 6 a & b are trapezoid shaped, the waveform in figure 7 is peak-shaped.

All measurements were made with AC driver ICs under the same conditions and may give an idea which light output curve better suites the requirements for the human eyes. It is the trapezoid shape with its bigger amount of light above the average light output line. This means that area 1 is larger. Therefore the flicker will be much less visible.

Final Remarks

The report of the US Department of Energy comes to the conclusion that flicker is creating increasing attention from manufacturers, as well as the standards and specification community. Some manufacturers appear to be giving flicker increased design priority, as evidenced by the improved performance of new product generations. The IES and CIE are considering the development of measurement standards, and IEEE group is working on recommended

In figure 5 the yellow line shows the luminous ripple and the blue curve shows the current. The zero line is the red line and the violet line is the average light output.

Figures 6 a & b show two trapezoid light output waveforms and the related flicker parameters as flicker index and flicker %.

FACT BOX ON FLICKER MEASUREMENT

Percentage of Flicker

$$F_{\%} = (Max - Min) / (Max + Min) \times 100$$

The calculation of the percentage flicker is a simple and very often used method. With other words, it shows the relative relation of light variation between minimum and maximum light output. The result of this formula is a percentage, which means, the lower it is the better it is.

Modulation Index

$$F_m = \frac{Max - Min}{Average}$$

Another measuring method is the definition of the modulation depth. The modulation

index shows how much the light current signal modulates around the average signal. The larger the value for the modulation depth, the larger is the deviation from the average value. Small values indicate a small modulation which shows a good quality of the luminaire.

Flicker Index

$$F_i = Area 1 / (Area 1 + Area 2)$$

This is a more complex system for calculation of the flicker index which gives the best comparison of the measuring results. At this method the total emitted light current of the light source will be used for the calculation and not only the minimum

and maximum values. By calculating the area below the shape of the curve will be calculated the total area, the average and the area above the average. A flicker index puts the light current which is over the average into relation with the total light current. The result is in the values between zero to one (0 – 100). Also here is the rule: the lower the better. But you have to consider that the flicker index system gives better results to compare but it does not include the periodical light change – basic frequency – into the calculation. This means, if two luminaires have the same flicker index value the luminaire with the higher light change basic frequency is the better one.

by Wolfgang Endrich

practices for evaluating flicker risks. Collectively, these efforts may make it easier for designers and specifiers to minimize the risk of flicker-induced problems for their clients in the near future. ■

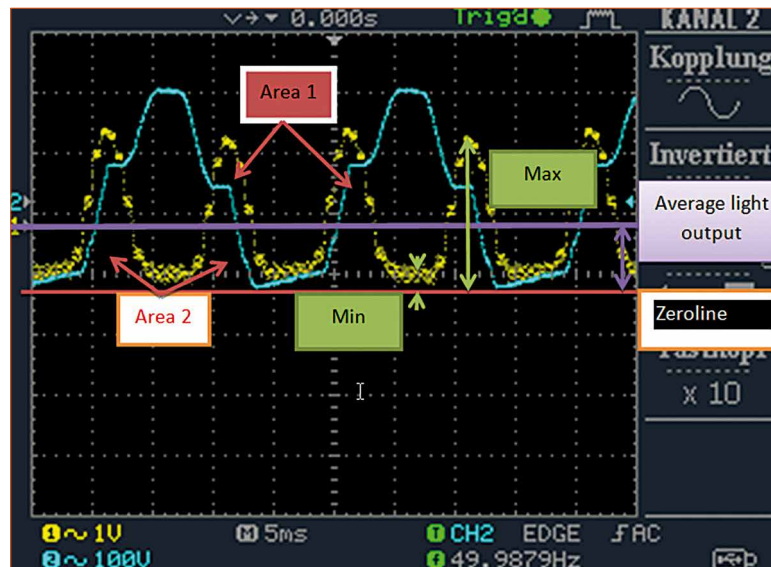

Figure 7:
A more peak-shaped waveform of the light output from another AC driven approach

References:

[1] SSL.energy.gov - the direct fact sheet feedback to: SSL.Fact.Sheets@pnnl.gov.

Software Design in LED Lighting Applications

Creating light with LEDs is a fairly complicated task. A lot of small problems need to be solved before AC or DC voltage is converted to the desired visible light. This conversion is done by electronic control gears (ECG), often called LED ballasts or LED drivers (although this naming is sometimes considered to be a bit incomplete). Attila Tomasovics, application engineer at Infineon Technologies, discusses a new emerging trend whereby, instead of dedicated ASICs or general-purpose microcontrollers, hybrid digital controllers control these LED drivers.

Electronics for controlling LEDs is evolving rapidly. It has gone a long way from simply applying voltage over a red LED diode with a resistor in series back in the 1960s, all the way to flicker-free dimmable RGBW LED source with dual-stage power supply and (secure) DALI or wireless communication options for connecting to the Internet, also including motion and ambient light sensors, and all that compliant with the latest safety standard for LED control gear (IEC 62733). On top of that, many LED driver manufacturers (in order to save on design, production and logistic costs), design a single hardware platform which could serve multiple purposes (e.g. different power ratings, different constant current ratings, etc.). These “universal” drivers are then often configured just

before installation, for example, by using NFC technology to change key parameters in software. Providing all of these functionalities at the same time or only some of them would hardly ever be possible today without using a microcontroller. Obviously there are many aspects of LED control gear development that designers need to consider when designing a modern, microcontroller-based LED driver, and software plays a crucial role in addressing them. This article provides an overview about the microcontroller-based LED driver design, and in particular, about the role that software plays in the design process, as well as ways that semiconductor vendors can help designers get their products to the market fast without compromising on quality.

Common Topologies of Modern LED Drivers

Modern LED drivers are essentially specialized intelligent switch-mode power supplies (SMPS) tailored to LED lighting applications. These power supplies contain switching elements and magnetics to convert the power. Their power rating is typically in the range of 10-100 W, and rarely ever exceeds 200 W. Depending on the required size, efficiency, light quality, power factor and cost, these switch-mode power supplies can be built around several switching topologies. These switching topologies may appear different at first but they are fundamentally very similar to each other. Some typical topologies used in these types of applications would be: flyback converter, boost converter, buck converter, buck-boost converter, flyback converter + buck converter, boost converter + buck converter, boost converter + flyback converter or boost converter + resonant converter (e.g. LLC). Less commonly in use are forward converter, push-pull converter, etc. Depending on the topology, the output delivered from an ECG may be regulated constant voltage, constant current or constant power. On the other hand, an AC input may need to be shaped to achieve a required power factor and low total harmonic distortion by use of active power factor correction (PFC).

Figure 1:
Typical Electronic Control Gear (ECG)

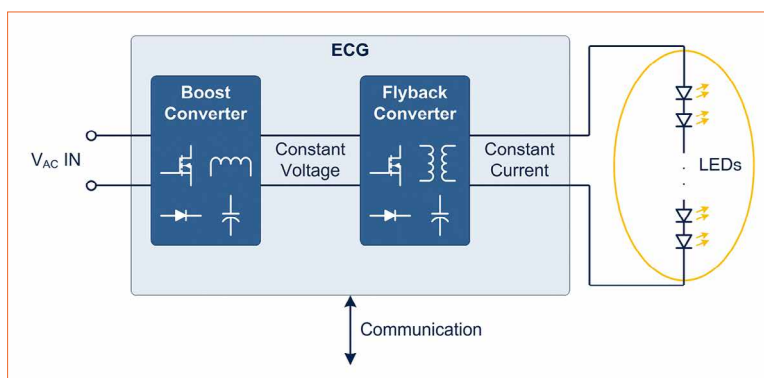

Once a designer decides on topology, there are more decisions to be made. Many of these topologies may be controlled in several different ways using various control methods.

Control methods:

- Continuous conduction mode
 - Voltage control with analog/digital compensator where the compensator type may be PI, PID, 2p2z, 3p3z, etc.
 - Peak-current control with constant off-time
 - Hysteretic current control
- Discontinuous or boundary conduction mode
 - Peak-current control
 - Constant on-time control
 - Constant on-time control with valley switching (quasi-resonance)
- Resonant control

Continuous and discontinuous conduction modes refer to the current in the inductor or transformer of the given topology. If the current never reaches zero, this mode is considered continuous. Despite having a very complex and sophisticated engineering theory behind them, most of these topologies and control methods have similar basic principles with some variations, and typically involve some or most of the sub-tasks listed below.

Subtasks:

- Zero-current detection (ZCD) and handling
- Peak-current detection and handling
- Input/output voltage detection and handling
- Overcurrent protection
- Overvoltage protection
- Analog or digital voltage compensator
- A state machine that turns the switching elements of the converter (e.g. MOSFETs) on/off at the desired time
- Various delay logics

An LED driver executes many of these sub-tasks sequentially or in parallel and, equally importantly, communicates with its environment and performs high-level light control.

The Intelligence in LED Drivers

Although completely discrete solutions are possible, typically one or more ICs are used for sensing and control in the LED driver. They may be primarily analog or digital in nature. Ideally only one IC can perform all LED driver functions.

In the past these ICs were either analog ASICs made to address one or a couple of topologies with one control method, or general purpose microcontrollers that relied on user software and several external components to address almost every topology or control method. Microcontroller-based solutions used to be associated with higher cost and effort on one hand and lower performance on the other hand, due to lower levels of integration, no sophisticated control peripherals and the need for

software development which was the skill that power supply designers were (and many still are) typically missing. ASICs, on the other hand, are inflexible in the sense that they can only be used for the topologies and methods they are designed for. For any new topology or method a new ASIC has to be developed. Communication and user-defined intelligence has been traditionally addressed only by microcontrollers.

A natural desire of developers has been an IC that can address a wide range of topologies and user requirements and that is also easy to use as an ASIC. Although ASICs are still regularly designed to address specific, very high volume driver applications, the recent trend is that semiconductor companies embrace a hybrid approach and create microcontroller platforms with ASIC features for LED drivers that try to address many different LED topologies and control methods. These digital/analog platforms include hardware building blocks that perform the subtasks mentioned earlier and software that links these sub-tasks,

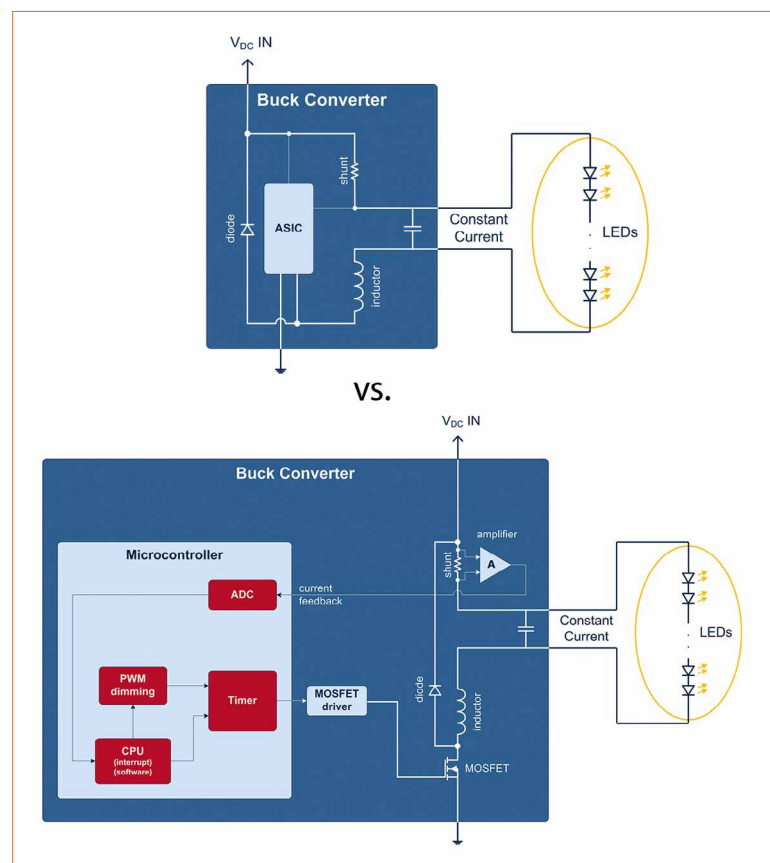

Figure 2: Typical buck-based LED driver controlled by ASIC or microcontroller

Figure 3:
Hybrid microcontroller
with semi-autonomous
hardware building
blocks

communicates with the environment and provides high-level intelligence. The typical hardware building blocks include:

- Analog comparators which perform functions like: zero crossing detection, peak-current detection, overcurrent detection, overvoltage detection. These comparators often include more intelligent features such as leading-edge blanking and slope compensation.
- Complex timer-based state machines with multiple inputs and outputs and interconnect options, typically used to switch MOSFETs, but also perform other timer functionalities.
- Modulators with various dimming, color control and mixing functions.
- Complex interconnect blocks with multiple inputs and outputs, edge detectors and glue logic to directly connect hardware blocks in the microcontroller (e.g. ERU).
- Digital-to-analog converters that are mostly used for comparator reference inputs, but also for protection and monitoring purposes.
- Communication modules such as DALI, I²C, etc.

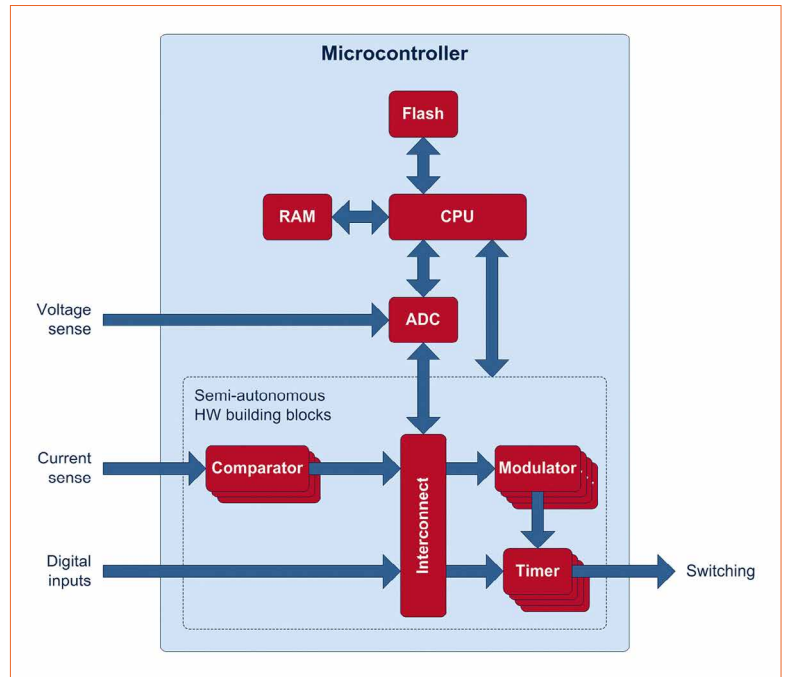
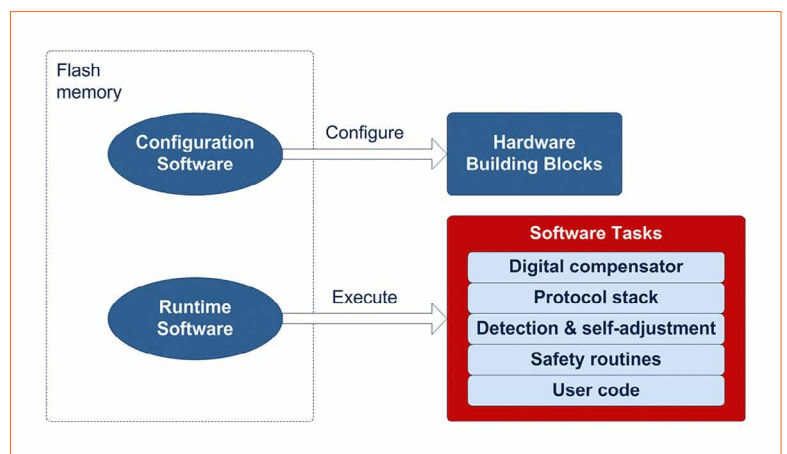

Figure 4:
Configuration and
Runtime software



The trend is that all these hardware building blocks are becoming as autonomous as possible, resulting in high performance modular control systems mostly independent from the CPU core. This would suggest that software development is gradually becoming less important because hardware is taking away the complexity of programming these sub-functions. However, exactly the opposite is true for two reasons: First, the high level software becomes more complicated as lighting applications evolve to be ever more sophisticated so microcontroller cores (running the software) spend more and more time interacting with the environment, managing safety and security, creating dynamic light scenes, and generally acting smart. Second, the flexible hardware building blocks have to be

configured to work together as the LED driver system requires, similar to how it is done in FPGAs. Thus, the required configuration software can be fairly complex, depending on the selected switching topology and control method.

Consequently, microcontroller software can be arbitrarily divided into two parts: configuration software and runtime software. Configuration software does what its name suggests: it sets up and interconnects all the hardware building blocks to act as required for the given topology, control method and behavior. This task is not time critical but it may be rather complex so it may occupy a lot of program memory. Runtime software typically includes a compensation algorithm, a communication stack, load

detection and self-configuration, color mixing scheme, safety routines, commissioning routines and other high level user code. Other than communication stacks, much of this code may be non-standard and highly specific to the given user application.

Controls and Communication

Most common communication protocols used in lighting are DALI, KNX, DMX512 or RDM, ZigBee and other similar RF protocols, including NFC which is used for commissioning. The lower protocol layers are often served by dedicated hardware blocks (e.g. DALI module with frame buffering, address detection and interrupt generation capabilities). Higher layers are taken

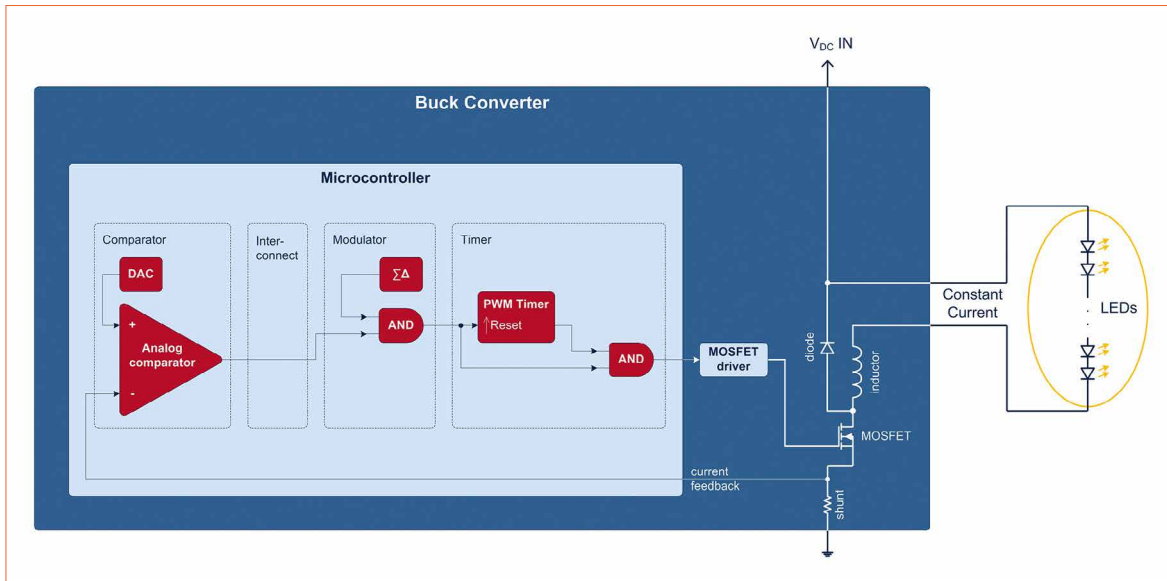

Figure 5: Hardware building blocks configured for continuous conduction mode buck converter with peak-current control using constant off-time

care of by the protocol stack. The protocol stacks are often standardized and sometimes have a very large memory footprint. On the other hand, due to the comparatively low communication speeds, executing the stacks requires relatively little CPU time.

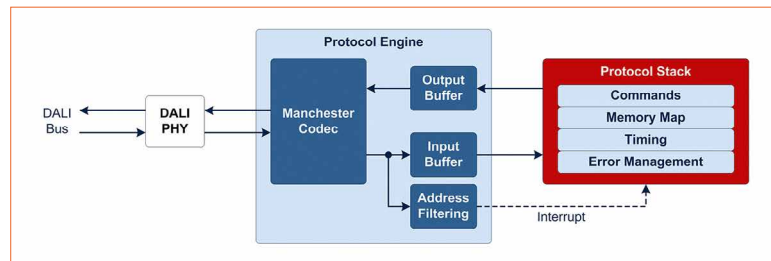

Figure 6: DALI protocol engine and protocol stack

The Holy Grail for semiconductor companies is to provide a software package to their customers that would be easy to apply and adjust to the most of possible use cases. This would essentially be a collection of different configuration software examples or libraries covering different topologies and control methods. Such software would be an excellent starting point for the widest range of new product developments and would be the enabler for the fast time to market. Such ideal, universal software still doesn't exist, but the trend is that semiconductor suppliers provide some kind of code repository based on a large database of many possible topologies and algorithms. Intelligent code generators based on these code repositories are often able to manage microcontroller hardware resources, provide an easy graphical interface to the application developer and automatically generate configuration software and parts of the runtime software. These code generators facilitate the necessary interconnects and assign hardware building block resources to

functions. This approach greatly reduces software development time by taking away complexity of programming "standard" algorithms or control methods specific to a certain microcontroller type. To further reduce software development time, semiconductor vendors often offer communication libraries and communication stack, such as DALI, KNX, ZigBee, etc. There are also commercial communication stacks and software available from the companies specialized in providing microcontroller software. In order to enable faster time to market, semiconductor vendors should also offer special software addressing functional safety (e.g. new IEC 62733 safety standard Lighting ECGs) or security (secure remote access, cryptography).

Microcontroller Platform and Software

There is a strong belief that the software development time can also be reduced by using a "standard" microcontroller core (in the last decade Cortex®-M cores from ARM

Ltd. have become "de facto" standard, at least for 32-bit microcontrollers, given their ever increasing market share). This may be true for "general purpose" microcontroller applications. However, the specialized building blocks in different microcontrollers aren't standardized across competing devices, so the availability of graphical auto-code-generators becomes even more of a necessity for fast development. Application developers are usually familiar with the standard core and its ecosystem, but not with the non-standard hardware building blocks of the different microcontrollers.

The way the LED drivers are developed has been evolving. Although simulation tools have been getting a lot better recently, developers still need to design the physical printed circuit board and populate it with the right components after deciding on the appropriate switching topology and control method. What's new is that instead of just using a dedicated ASIC, they often take a

Figure 7:
IDE with code repository

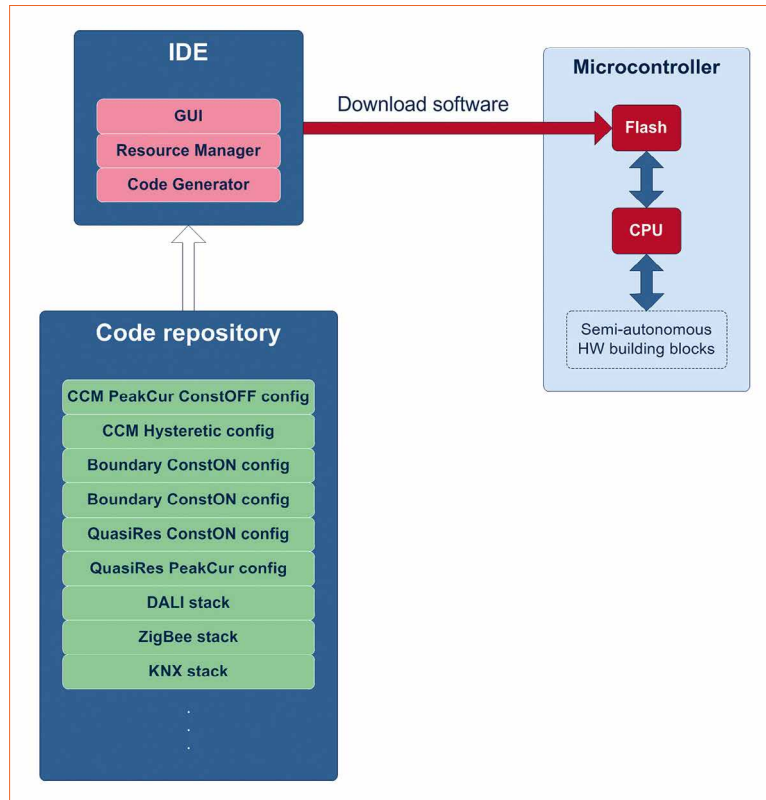

microcontroller platform and prepare the control hardware by writing configuration software to select, configure and interconnect the right hardware building blocks. This process is made faster and easier by the graphically configurable code generators based on code repositories mentioned earlier. These generate most of the configuration software automatically. Ideally, the code generators themselves have a modular and transparent structure, so that software blocks (e.g. control

algorithms) can be replaced by newer and more advanced user-defined software (e.g. adaptive nonlinear control).

To conclude, this somewhat idealized application development process is still very tedious and far from ideal. However, once established on the market, it will help designers save their precious time that they could spend on writing software that differentiates their product.

Examples for software based product differentiation:

- Software that makes use of all the benefits that emerging Internet of Things has to offer: interaction with other devices, with the building automation master, remote access via smartphones, etc.
- Human centric lighting, where the color and intensity of light depends on the presence of humans, time of the day, intensity of the sunlight, etc.
- Ambient lighting effects, dynamic scenes, etc.

Concluding Thoughts

LED Electronic Control Gears are one of the fastest growing segments in power supplies, according to the recent IHS Market Research report. There will be many suppliers offering different LED Drivers trying to capture a piece of this fast growing market. By using a type of modular approach in both hardware and software design described in this article, companies that aim to be leaders in this market will be able to offer enough variants fast enough at reasonable development and production costs. ■



2000 K High Performance Flexible Strip with NICHIA LEDs and INFINEON IC

Willighting announced a new and creative design LED strip with amazing color in 2000 K.

- Using SMD3030 Nichia LEDs and Infineon IC to ensure high quality
- 24 V 126 LEDs/m in 2200 lm
- @50, @40 mA and @30 mA could be available
- CRI > 80
- 10 mm width

For more details, please visit www.willighting.com or contact us at sales@willighting.com



Visit us at
light+building
Hall 6.2, Booth C04

13.-18.3.2016
Frankfurt a.M.
Germany

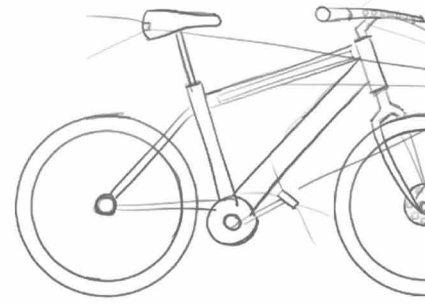
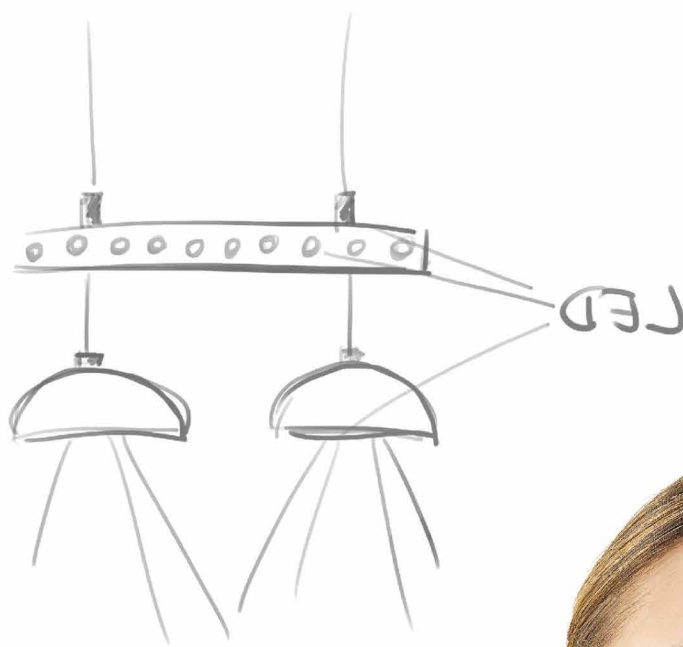
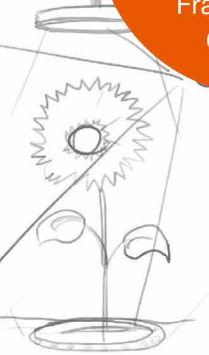

**YOU HAVE THE IDEA,
WE HAVE THE SOLUTION.**

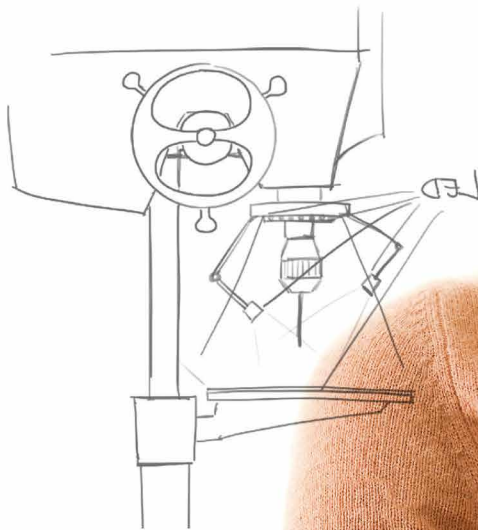

Rely on our extensive experience when implementing your LED lighting idea. We provide customized solutions and support you professionally in the realization of your project. Put us to the challenge!

For more information, please see www.ledlightforyou.com

LLFY Selector App



The network for LED lighting technology

LED  **Light for you**
powered by OSRAM

Predictive Simulation to Virtually Test Product Design and Reduce Time to Market

With technical progress and new regulations, shorter product cycles are a continuous challenge for OEMs. Modelling is one measure to cut time to market efficiently without compromising product quality. Trinseo Technical Service & Development specialists Kersten Terry and Berend Hoek explain the process of computer-based simulation, specifically applied to injection molded plastic parts. Through case studies, they showcase how Trinseo's Application Engineering Development resource facilitates more effective LED-lighting development relative to part design, tool design and material selection by modelling "real world" performance.

LED lighting offers the lighting industry several advantages including increased energy efficiency, durability and design flexibility. In addition, as regulations, consumer demands and material expectations evolve, OEMs are rushing to introduce more and more innovative and sophisticated lighting units to create and maintain a competitive advantage. To determine the most effective and efficient way to leverage the various design possibilities for LED lighting and to deliver on complex demands, manufacturers are using advanced development methods to design lighting components, which, at an increasing rate, are being made of plastic.

Computer-based simulation technology, also known as Virtual Prototyping, offers developers a cost-efficient approach to designing the exact application they need without wasting time, materials or production effort on an approach that could produce unsuccessful results. It allows

manufacturers to ensure that their end-applications will address design and functionality needs and meet project specifications prior to production. The upfront work done using this method ultimately results in shorter-to-market development time and reduced tooling cost, which for an OEM is a significant benefit. Without simulation analysis, OEMs are often unable to identify design and functionality defects before they occur, which can lead to issues such as flawed light diffusion, uneven surfaces, inaccurate haze levels and poor mechanical properties in the final product. Encountering these issues late in the development process, or once production is about to begin, costs manufacturers time and money as they must not only determine the root cause of the defect and the solution for preventing it, but also modify the development process itself, which can include having to redesign a tool or make investments in alternative materials.

Computer-Based Simulation: How and When It Works Best

Computer Aided Engineering (CAE) technologies are not only used to model fabrication processes but also to predict how end-products will look and final assemblies will function. One of the most effective of these methods is Computer Aided Design (CAD), where software is used to create a digital prototype of an injection molded plastic part or assembly and demonstrate "on the screen" its functional and in-use characteristics. By digitally simulating an application and the processes it must undergo, developers and manufacturers gain critical insight into not only its aesthetics and functionality but also how each element involved with producing the application - ranging from upfront design of the tooling to the material used - will impact the overall performance of the end-product.

Many OEMs conduct their own computer simulations focusing on an application's functionality. However, creating digital replicas without specifically targeting the material used in the fabrication

process prevents manufacturers from envisioning a key foundational element of the application and its manufacturing process, potentially resulting in a less than satisfactory end result and costly re-development efforts. Involving material suppliers in a simulation may be beneficial and could provide a more holistic view of an application development process, because the material supplier offers a more in-depth understanding of the materials used and their potential behavior during processing. In turn, a material supplier's simulation can help OEMs reduce the risks in an overall production process, eliminating costly trial-and-error when developing a physical product. This ultimately helps companies bring new and better concepts to market faster.

To develop a computer-based model, a close collaboration with customers is very important. OEMs approach the development team for one of two reasons:

- Guidance on planned injection molded plastic parts with specific performance or design requirements or
- Advice on already-developed applications with issues / concerns that need to be addressed

The application engineering development specialists then work with OEMs to create brand new or modify existing designs by using various CAE simulation processes based on material-specific properties, the OEM's geometric definition of the part, and any requirements imposed on the end-product, e.g., impact, optical, UL regulatory, etc. Using this information in simulations, developers can predict the mechanical behavior of the part and recommend further optimization. They can also create virtual prototypes using desired material specifications that can solve an existing design or functionality issue, observing flow and mechanical properties in an injection molded

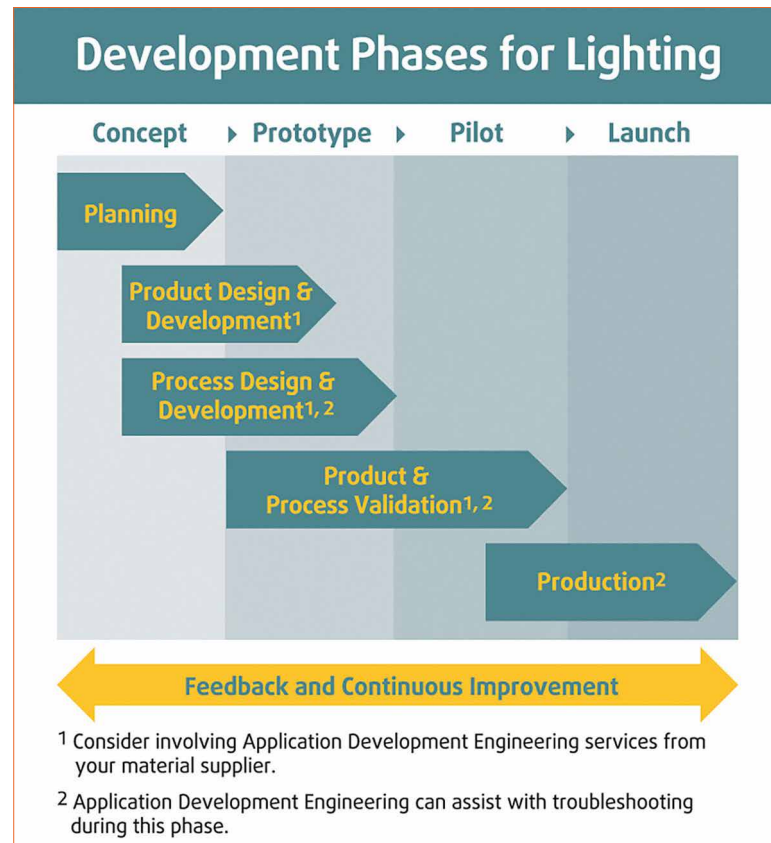

Figure 1: Development phases involved in designing and manufacturing LED components

part. Once the prototypes are created, the OEM can produce the end-product with increased confidence in the final result.

Computer-based simulation can be beneficial at any point of an OEM's development process, whether upfront when creating a new injection molded part or "at the back-end" when troubleshooting issues that may surface in an existing part or when optimization is needed. It is most cost-effective however when CAE is used before production begins, similar to developing a Failure Modes Effect Analysis (FMEA) in the production world, as a means to anticipate and then prevent potential failures.

A typical development process for LED lighting includes different phases from planning to actual application production (Figure 1). During the planning stage of development, ideas are sketched out, perhaps on just a note pad. During product design & development, CAD files are developed for the molds to create the plastic parts and perhaps prototype tooling is built. During

process design & development, the manufacturing phase is tested out, and process parameters in the molding process are identified. For plastic injection molding, pressures, temperatures, speeds are determined to produce plastic parts. Next, the product and processes performance requirements are checked during the product & process validation phase. Finally, the application goes into production.

When involved upfront in the development process, material suppliers can help OEMs achieve their goals by foreseeing trouble areas ahead of time and developing a specific material grade needed to create an optimal LED-lighting part. While it is most common to use computer-simulation to intervene during either the process design & development or the product & process validation phases as indicated by figure 1, it is also possible to involve simulation studies at earlier stages in the process such as in the planning or product development & design phases.

Figure 2:
Correlation of Cost of Change vs. Time indicating a steep increase in cost as development progresses

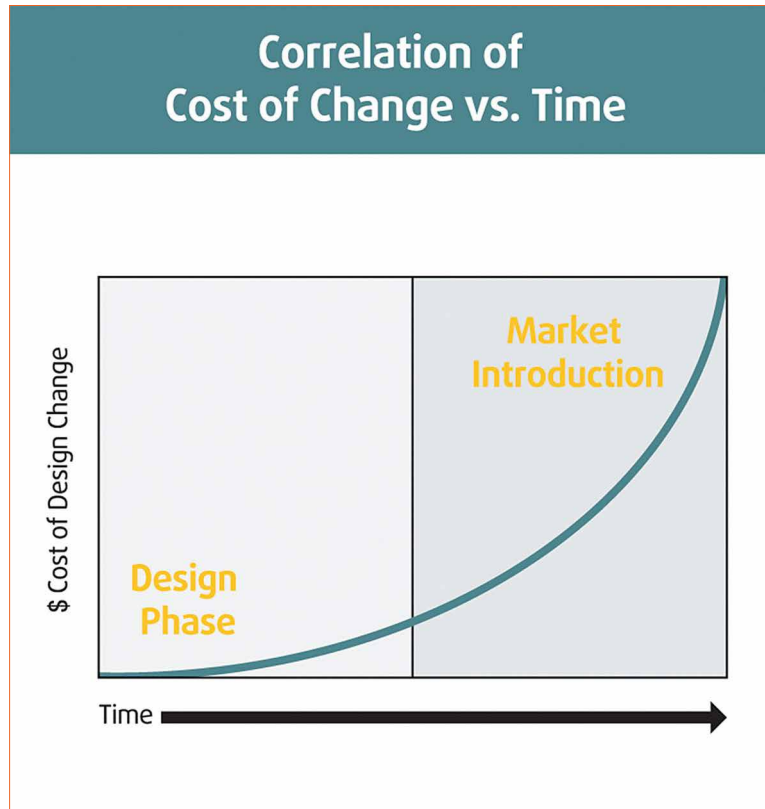

As seen in figure 2, the point within the development process at which OEMs choose to digitally produce end-products has a direct impact on related production costs. Computer-based simulation reduces potential financial risks at an increasing rate as project lead time increases. The longer a company waits to use computer-simulation, the more costly the repercussions can be. For example, if an OEM introduces simulation during the tooling design phase, it can avoid costly changes that would likely be encountered after an investment has been made, the tooling has been built, and/or production has started. Modifications to an existing tool design or an investment in brand new tooling may be prohibitive. Similarly, the more technical and complex an end application (assuming cost also increases) the more the development and production process will benefit from computer-based simulation early in the design phase.

Application Development Engineering was first introduced by Trinseo to customers in its automotive business, where it is typical for a material supplier to be

involved in the design phase of injection molded plastic automotive parts. In one of its first computer-simulation partnerships, through extensive research and development, it was possible to gain an understanding of the effect of adding Long Glass Fibers (LGF) to a polymer and how processing methods affected the performance of the final part. Long glass fibers are used to enhance the mechanical properties of thermoplastics which then can be used for applications to reduce weight or even replace traditional heavier materials such as steel. With its simulation expertise, it was possible to develop applications meeting the desired level of mechanical performance required by the customer without having to rely on trial and error and without going through multiple prototype phases.

This methodology of simulation can be used much the same way in LED Lighting. With its complex needs for intricate part design and increasingly strict market regulations for safety and efficiency performance the LED lighting industry potentially has much to gain. Computer-based simulation

gives OEMs virtual control over a wide array of design and material considerations necessary to create an injection molded part while allowing them to avoid the costs of trial and error, i.e., trying multiple options in real-life production not really knowing the outcome. Additionally, as plastic materials are used more and more regularly for the components of LED devices, CAE technology becomes even more advantageous to manufacturers, allowing them to test different polymeric solutions to achieve the right material-property balance for an optimal end-product in design and functionality.

Computer Aided Engineering (CAE) Studies: Where to Begin To conduct a CAE study, an application development engineer requires the following:

- A CAD drawing of the plastic part that needs to be injection molded
- Polymer characteristics such as viscosity vs. temperature and shear rate data, melt mass flow rate, thermal conductivity, specific heat, pressure-volume-temperature
- Processing parameters used or anticipated by the injection molder, e.g., temperatures, speeds or pressure
- Desired performance description, e.g., no weld lines or drop testing mechanical performance
- Description and/or actual parts demonstrating the issue or concern
- CAE software for conducting process- and/or mechanical simulations

Using this information the engineer can run simulations to predict how the material will enter a mold and where potential defects may occur. They can predict weaker areas that might be susceptible to breaking due to being a high stress area.

Using this approach, the following case studies show how CAE may be applied to enhance or optimize designs for injection molded plastic components used in lighting.

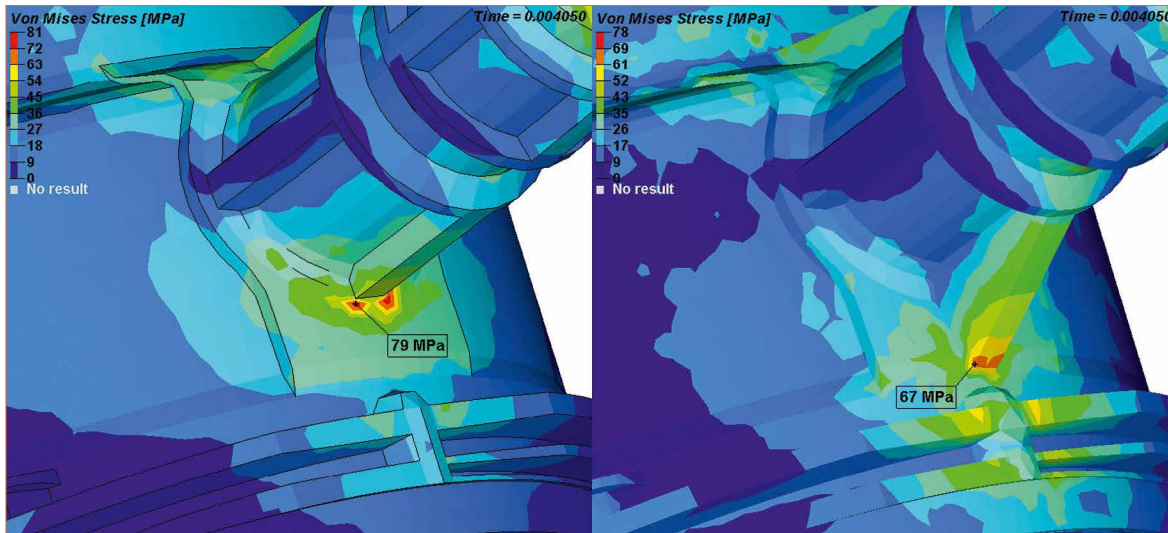

Figure 3: Drop-test simulation for identifying the weak point in a product prototype and suggested improvement using a rib

Case Study: Meeting Mechanical Design Requirements

One of the most significant benefits of LED lighting is the freedom of design it affords, where designers and manufacturers are able to offer end-customers specialized shapes for their lighting applications for specific functionality and aesthetic needs. The desired form and function of the lighting should dictate the development process starting at the time of project planning. If the part is designed without considering performance standards, manufacturers can encounter issues that could potentially cost them both time and money in adjustments that must be made “after the fact.”

To help one of the customers avoid such a situation in its development of a new product, the development engineers used computer-based simulation to highlight a specific area of a plastic injection molded light fixture. The OEM needed to ensure the strength of the end product, making sure it could endure impact without breaking. The developers used simulation to predict the optimal product design that would achieve this desired mechanical performance.

To approach this project, a “Drop-Test” study was simulated where a virtual prototype of the final part was created via computer-aided design. Different impact scenario’s were

simulated that were equivalent to those associated with the part falling onto a concrete floor and analyzed the behavior of the prototype. That helped to pin-point the weakest and most vulnerable areas of the part. As seen in figure 3, the area is most susceptible to breakage were the connections protruding from the base of the application.

After determining the most vulnerable areas of the application, the developers were able to identify solutions to support these areas of the part design. In this instance, it was suggested to add reinforcement ribs near the weak connection in order to strengthen the part overall. Given that the simulations were done during the process & development phase, the OEM was able to incorporate these suggestions into the tool design that would be used for molding the part and therefore avoid expensive modifications that would have been needed if the part had been produced without first conducting the simulation of the drop-test.

Case Study: Choosing the Right Material

As the lighting market requires more performance properties from its devices - including cost savings, energy efficiency, and light-weight parts - the material used to produce the LED parts plays a critical role. Given their ability to be custom

tailored, plastics, such as polycarbonate and polycarbonate blends, enable a manufacturer to reach stringent part performance requirements.

To meet the desired form and functionality of an application, while keeping production costs low, OEMs can use computer-based simulation. The virtual prototypes help developers foresee how a material will react throughout processing and visualize any potential defects or performance failures in an end application, therefore helping to determine the right material to be used to avoid any issues. If implemented after the fabrication process, these defects will not appear until the product is already cast in a final shape, causing OEMs to scrap defective parts, choose a new material and re-fabricate an application. This of course represents another costly error.

In a related instance, a customer had observed light deflection in one of its plastic, injection molded lenses. To determine the cause of the issue, the developers combined their extensive material knowledge with CAE tools to digitally recreate the lens and simulate the process of filling its mold with two different material options.

The simulations showed that the materials behaved differently relative to filling pressure, filling pattern and

Figure 4:
Comparison of
calculated deflection of
two materials

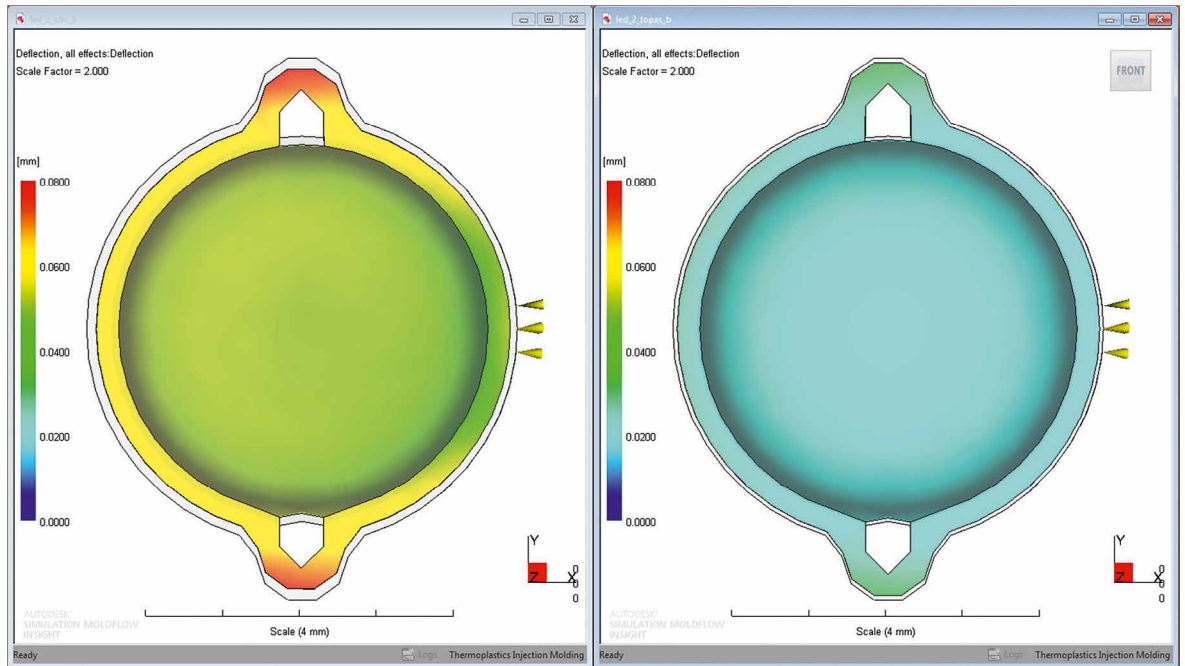

cooling sequence. Through this comparison, developers were able to see that the viscosity of each material directly affected how the material performed during each of these phases and resulted in different shrinkage levels at the end of the production process. The more shrinkage, the more the lens's shape and size was distorted, therefore causing unwanted light deflection.

In the final phase of analysis, the developers could easily see the distinction between the two grades of plastic. Material 1, with a higher required filling pressure also resulted in a higher shrinkage and possessed a deflection of approximately 2 times higher than that of Material 2. Material 2 displayed less shrinkage during the simulation (Figure 4). As a result of the computer-based simulation of this production process, it was possible to confirm that the issue could be prevented through the correct choice of material. As a consequence, the optimal polymer grade for avoiding shrinkage and the subsequent deflected light in the end-product was suggested (which would be more uniform, in the case for Material 2).

Case Study: Determining the Proper Mold Filling Process

To translate an application design that is specially developed to meet specific performance and aesthetic requirements into a viable production process, OEMs must create tooling or molds that not only meet required specifications but, at the same time, ensure consistency of each part or component. Creating these tools involves considering the application's specifications and accounting for how the chosen material will behave within the tool during the fabrication process. Even after taking necessary precautions, manufacturers may

still be confronted with unexpected problem areas in a final molded product, including aesthetic defects such as visible weld-lines (a small line appearing on the surface of the application, created by two flow-fronts joining each other) and potentially inconsistent coloring.

A customer encountered such an issue after the mold was created and production began. The customer noticed areas of unwanted grey streaks near the weld-line on its final molded product. The OEM originally concluded that the defect was due to material degradation, but after conducting a 3D part surface scan simulation (Figure 5), the developers

Figure 5:
3D surface scan
showing fiber
orientation of material –
inset images – on both
sides of the visible
weld-line on the end-
product

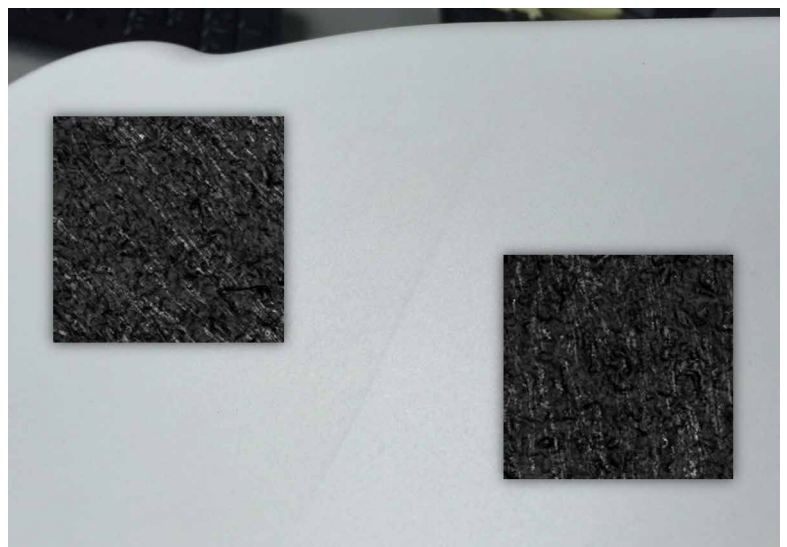

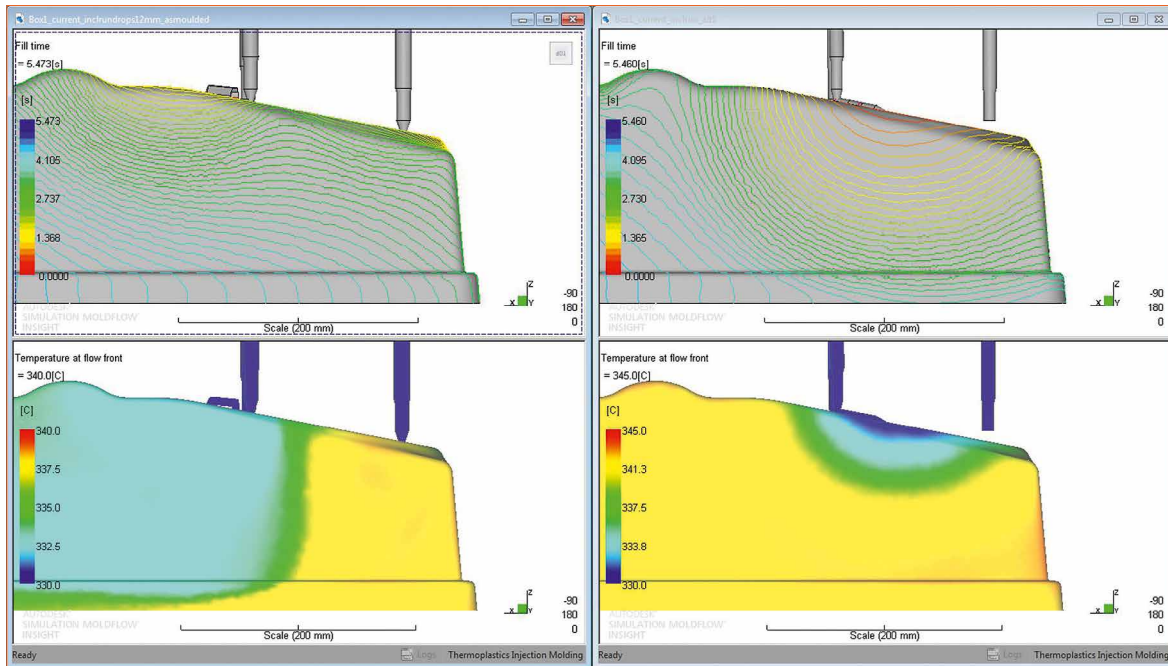

Figure 6: The image on the left shows weld line formation, the image on the right shows a gating scenario which avoided the weld-line

saw that the glass fiber orientation varied on both sides of the weld-line, causing the light to deflect differently in these areas and create the illusion of lighter- and darker colored zones. The team used computer-based simulation to observe precisely how the mold was being filled during manufacturing and ultimately to pinpoint how the defect was occurring in the end-application.

The design engineer simulated the mold-filling process, comparing various mold-filling sequence options, including when each gate - the opening where the material is injected into the mold - is used during the filling process. The mold filling simulation software is used to identify how the polymer flow front is filling the tool cavity. The flow front in an injection molding process is the position of the molten plastic in the empty mold cavity. In the simulation images below, the filling process and the alternative ways of part filling are mapped and displayed through color coding where red represents locations in which filling first begins at time zero seconds, and dark blue represents the final filled areas, after five to six seconds (Figure 6). This information allowed the team to determine how and where in the part the material creates weld-lines.

In this particular example, the mold originally employed five different gates where the material was injected into the mold. The material's behavior was simulated, varying the filling sequence. By changing the sequence in which the gates fill the mold the figures show the locations of where the polymer last fills the mold.

Comparing the different gate filling sequence, the developers identified a strong correlation between the regions showing the surface defects and the temperature of the material in these same areas. This difference in temperature was caused by the rate of material injection, pressure and, ultimately, cooling time. In turn, overcoming this temperature difference contributed to a more inconsistent texture reproduction throughout the part. From these results, it was concluded that the filling sequence should be altered to create a more uniform flow front temperature throughout the material, requiring a reduction of the gates used in the mold. Reducing the number of gates from five to three resulted in fewer weld-lines, more homogeneous temperature and a much more well-balanced filling pattern for the part overall.

Case Study: Evaluating Alternative Solutions

As LED assemblies become more and more complex, so too are the processes and materials used to manufacture them. Each step of the production process offers several opportunities for modifying and improving the final end-product, including multiple variations within the part design, tool design and material selection as discussed in the previous case studies. Often computer-based simulation will identify for OEMs potential causes of issues in end applications and even possible solutions for eliminating those issues. At such a point, the task includes determining the optimal solution among the choices presented to best produce the application not only according to performance demands and requirements but also aligned with the company's budget and timing needs. Using advanced production analysis and considering options, companies are able to test solutions and compare their end results, helping them to envision the best modifications to make in their production processes.

In one such situation, a customer faced a problem in its production process, resulting in an optical defect in an injection molded

Figure 7:
Visible weld lines
present an optical
defect in the end
product

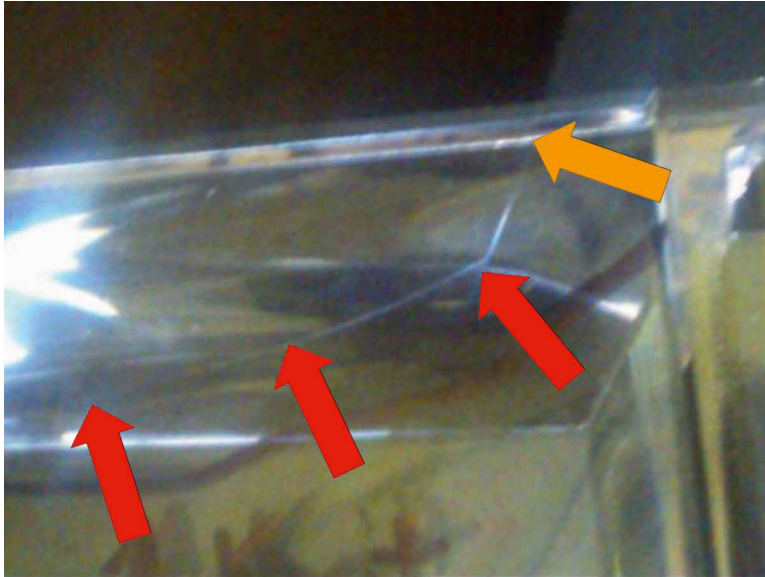

plastic part. This application displayed highly visible weld-lines at the point two sections joined one another (Figure 7). As the part design, tool design and material selection were already in use in production, the project required an in-depth analysis to pinpoint the cause and identify the optimal solution. Using process simulation, a so-called virtual “Short-Shot” study was created, which is a technique to help molders see more precisely how the mold is filled and the resulting part is formed.

From this benchmark simulation, it was observed that the optical defect was formed at the end of the

filling process, as shown in the image on the left in figure 8. (In this figure the blue areas represent mold sections that are filled first by material injection and red areas represent those filled later). Further analysis showed that the cause was related to the filling speed and direction of different material areas during injection, where the horizontal flow-front of one material section overtook the vertical flow-front of another material section that was moving upwards to join the gap during the filling sequence.

The developers then conducted further simulations to identify feasible alternatives for avoiding

this problematic “crash” of flow-fronts and to smooth out the filling pattern in order to eliminate the weld-lines in the end-product. After simulating several options to modify the part, such as altering the thickness of the part’s side walls, bottom, and front edges, the team discovered two potential solutions offering a similar improved result.

The identified solutions included:

- Option 1: modify the tool design, introducing an additional injection gate in the mold, and
- Option 2: change the material used for the application.

As seen in the image on the right in Figure 8, both solutions provided a more well-balanced filling pattern when compared to the original process. Either changing the tool design or changing the selected material would create a smoother flow-front of the injected material at the point of connection during the filling process and thereby facilitating a less visible joint, i.e. a cleaner connection between the two flow-fronts. This ultimately would eliminate the optical defect in the end-product.

With a deeper understanding of the optical defect’s cause and its potential solutions, the OEM was able to make an informed decision,

Figure 8:
Left image shows filling
pattern leading to an
optical defect while
the image on the right
shows a smoother
filling pattern, thereby
overcoming the weld-
line

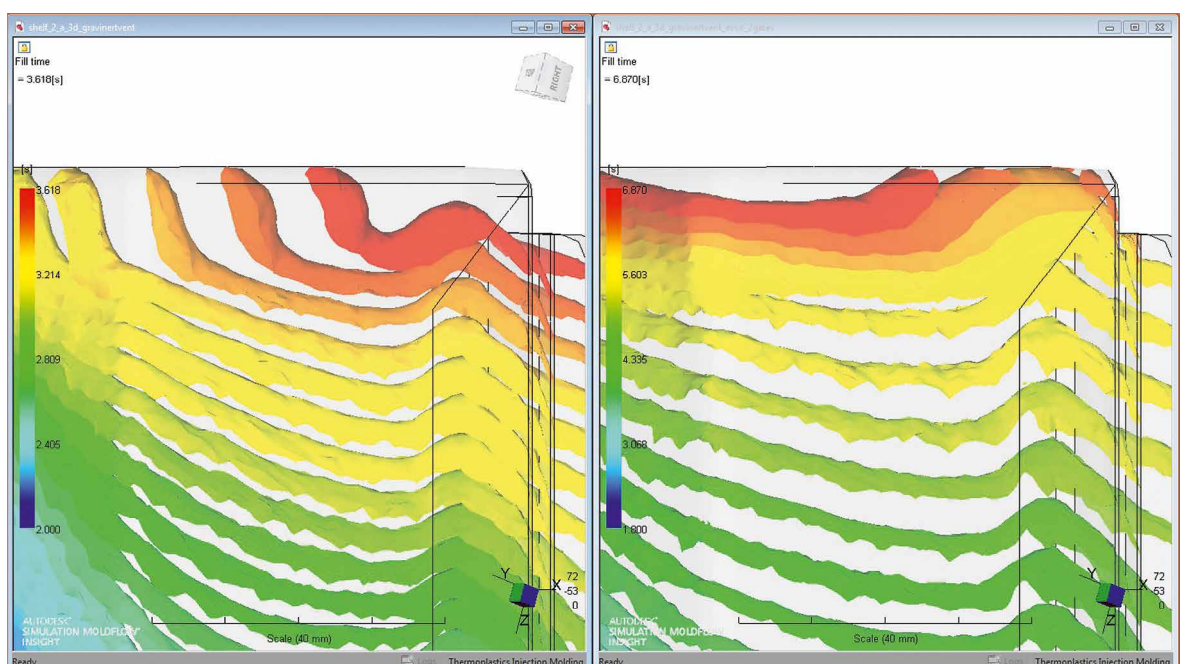

identifying the solution that best aligned with its existing production budget and timeline. Computer-based simulation offered the OEM the flexibility and confidence to choose the optimal solution for its final injection molding process without sacrificing the desired end-product performance or internal manufacturing objectives.

Conclusion: A Clear View Through Computer-Based Simulation

OEMs in the LED industry are no longer forced to wait until a production process is complete to fully assess their applications. Now with computer-based simulation, manufacturers can have a comprehensive view of an end-product's performance before investing time or money in the part design, tooling, material selection, or production. Through these virtual simulations, OEMs are able to visualize each factor that affects the application, from the behavior of material within a specific tool design to the precise sequence used during the injection molding manufacturing process to how a product's form can influence its ability to function in various situations. Equipped with this information, manufacturers can

be fully confident in their development decisions and move forward in their production processes without the risk of increased spending due to errors in design.

CAE technology is a proven methodology for anticipating molding performance and end product properties and with the added expertise of the plastics material supplier, computer-based simulations offer an accurate picture of a product to avoid potential design and performance issues and resolve any existing problems. In close collaboration with customers in the LED Lighting market, these simulations have helped solve issues that other material production partners could not resolve and even assisted in the creation of new product concepts that would have otherwise not been able to be launched.

While the LED Lighting market continues to grow, the challenges presented to OEMs increase. The sooner in their processes that these companies implement computer-based simulations, the more quickly and efficiently they can create products that will effectively serve the needs of the industry and offer opportunities to save time and money. ■

Advanced technology
for LED/OLED development & application gather!

Held inside **LIGHTING JAPAN 2016**

8th Light-Tech Expo

– Int'l Exhibition for LED/OLED Technology & Application –

January 13 [Wed] – 15 [Fri], 2016
Tokyo Big Sight, Japan

Organised by: **Reed Exhibitions Japan Ltd.**

Concurrent show: **6th Int'l Lighting Fixture Expo**

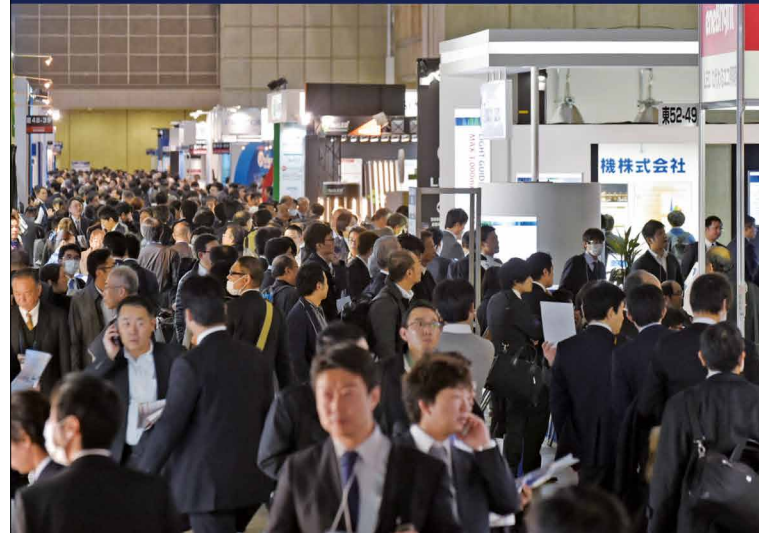

– **320 exhibitors with LED/OLED Technology**
for various applications gather –

Lighting

Automotive

Display

Agriculture

Medical

Mfg.
Equipment

Industrial



Register Yourself as a Visitor!

Request Invitation Ticket ▶▶▶

www.light-technology.jp/en/inv/

Boost-Buck LED Driver Topology for Low Input and Output Ripple for Low EMI

Many automotive LED driver circuits require constant-current DC/DC converter topologies that can both step-up and step-down the input-to-output voltage. Out of the commonly used step-up and step-down topologies, those that produce low EMI are the most desirable. Keith Szolusha, applications engineering section leader with Linear Technology, proposes a new boost-buck (boost-then-buck-mode) floating output LED driver to satisfy these requirements.

Automotive applications very often require constant-current DC/DC converters. To achieve a high efficiency, there are commonly four non-isolated LED driver topology options applied:

- Switch buck-boost for very high power and efficiency
- Coupled or uncoupled SEPIC
- Single inductor buck-boost mode
- Positive-to-negative (buck based) single inductor buck-boost

Unfortunately, none of these LED driver options has both a truly low input and low output ripple. Out of the need for such a converter, a new topology is created. The proposed new driver topology resembles the single inductor buck-boost mode, a single-switch-node SEPIC, and a positive version of a Cuk converter that also has low input and low output ripple. The topology features this low input ripple and low output ripple due to the input-facing and output-facing inductors (or coupled windings). The overall size of the combined boost-buck inductors (or coupled

inductor) is similar to the single inductor of buck-boost mode. The input ripple is similar to a SEPIC, but the output ripple is much smaller. The inductor size is the same as a SEPIC, but with a single switch node instead of two (a smaller hot-loop) and without the complication of a coupling capacitor between the two windings. The input and output ripple resemble that of a low-input and low-output ripple (inverting) Cuk converter, but again, without the coupling capacitor between the windings and most importantly without the need for negative-referenced circuit feedback architecture. The positive boost-buck can be built with available boost LED drivers, such as the new LT3952 that is used in the first application example.

Boost-Buck Topology and Floating LED Output

The new single switch 60 V monolithic LED driver IC with 4 A peak switch current can be used as an automotive boost-buck LED driver as shown in Figure 1. This 350 kHz, 1 A LED driver can power between 6 V and 18 V of LEDs from a 9 V to 36 V input with up to 90% efficiency at maximum load. The boost-buck converter efficiency is high due to the powerful internal MOS switch. The efficiencies with different LED string voltages are shown in figure 3. The versatile single, low-side power switch architecture can be used to power floating output step-up and step-down converters such as boost-buck and single inductor buck-boost mode. The LED string's voltage reference to ground is not necessary since LED output is visible light only. Because of this, the unique floating LED driver topologies such as boost-buck and buck-boost mode are possible.

This IC's ability to PWM dim the floating LED string with the floating top gate 'TG' pin PWM MOSFET driver fits nicely with floating LED loads. The boost-buck in figure 1 can PWM dim at ratios of 300:1 and higher (with 120 Hz frequency).

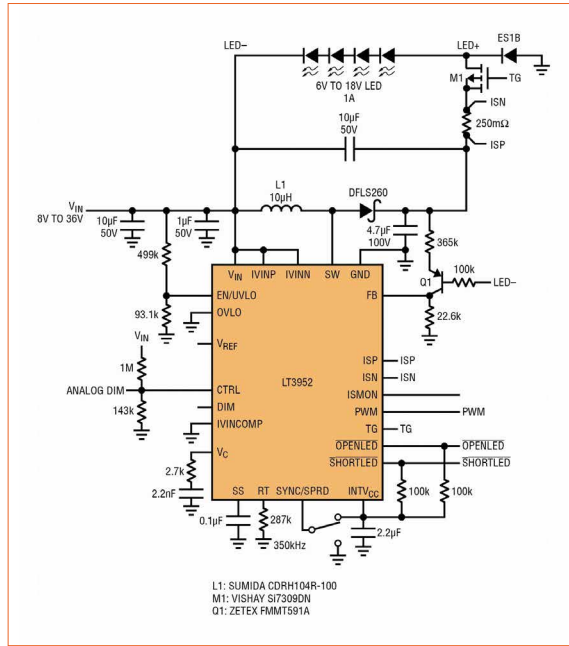
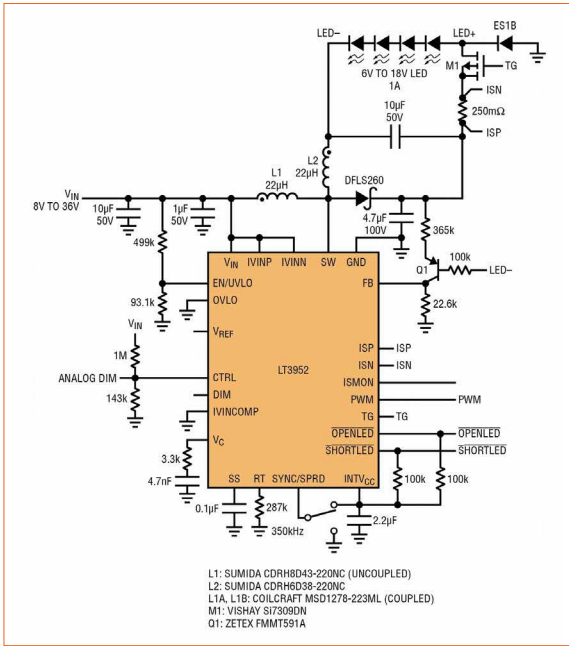

Figure 1 (left): The 9-36 V 6 V to 18 V_{LED} 1 A boost-buck LED driver has low input and low output ripple with 300:1 PWM dimming capability at 120 Hz and 90% efficiency

Figure 2 (right): A single inductor buck-boost mode LED driver used for comparison to figure 1 boost-buck topology

The high-side TG driver effortlessly provides PWM dimming to boost, SEPIC, buck-boost mode, buck mode, and boost-buck LED drivers. It even doubles as a short-circuit protection disconnect to protect against the dreaded LED+-to-GND incident. The IC protects against and reports short-circuit and open LED conditions in boost-buck topology.

Boost-buck LED driver topology can both step-up and step-down the input-to-output voltage as it regulates the LED current. Boost-buck duty cycle, efficiency, switch current, and OUT node voltage are the same as both single inductor buck-boost mode and SEPIC.

Here are some properties of the boost-buck LED driver:

- $V_{OUT} = V_{IN} + V_{LED}$
- $DC = V_{LED} / (V_{IN} + V_{LED})$
- $I_{swpk} = I_{IN} + I_{LED} + I_{Lpkpk} / 2$
- $I_{Lpkpk} = I_{L1pkpk} + I_{L2pkpk}$
- Efficiency of figure 1 is about 88% 12 V_{IN} to 18 V_{LED} at 1 A

Low Input and Output Ripple Topology Results in Low EMI

There are many similarities between boost-buck and single inductor buck-boost mode. What is not the same between figure 1 and figure 2 is the input and output ripple. Figures 4 a&b demonstrate the reduced conducted EMI of boost-buck versus buck-boost mode

(Figure 1 and Figure 2 respectively). The separation of input and output windings prevents the output ripple current from coupling on the input capacitor of the boost-buck, thus reducing EMI. The EMI of Figure 4 shows low AM band EMI from 530 kHz to 1.8 Mhz and less of a need for a large EMI input filter.

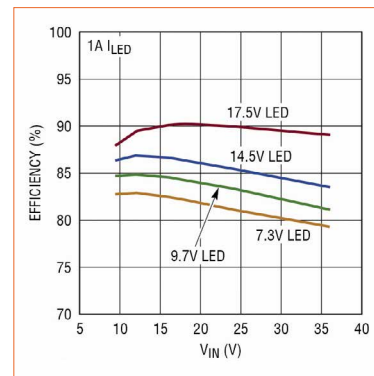
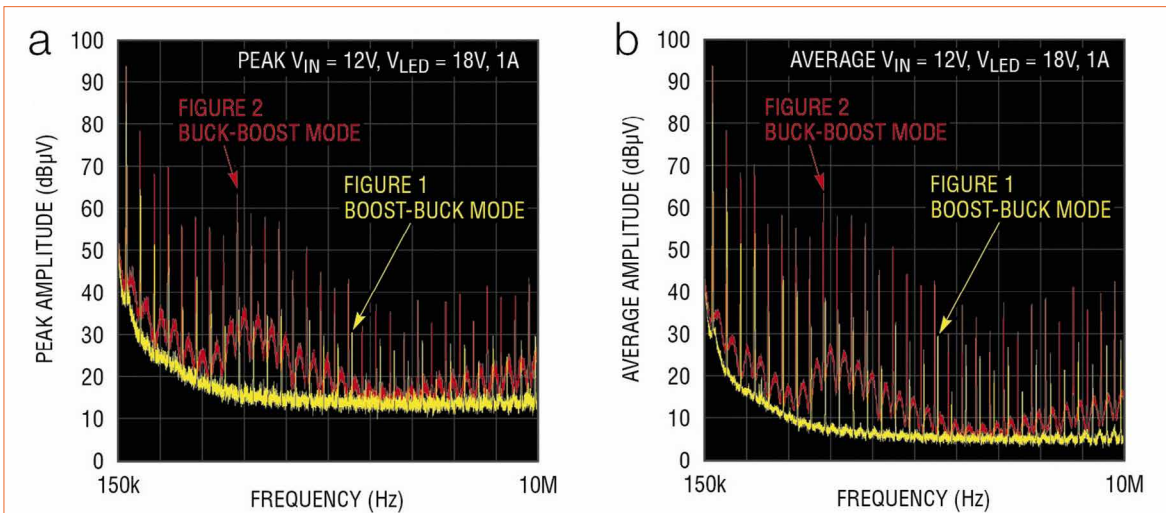

Figure 3: Boost-buck efficiency of figure 1 is as high as 90% with 12 V_{IN} and 17.5 V_{LED} 1 A LED string



Figures 4 a&b: Figure 1 boost-buck conducted EMI (a) is much lower than figure 2 buck-boost mode conducted EMI (b) for 12 V_{IN}, 18 V_{LED} at 1 A

Figure 5:
Boost-buck LED driver is similar to SEPIC LED driver topology

Figure 5 is an alternate drawing of the boost-buck topology, demonstrating the low in-and-out ripple paths in contrast to the SEPIC converter that does not have the same low output ripple. High ripple on either the input or output lines can radiate and increase EMI, especially if those lines are several meters long, as they sometimes are in a car. Additional LC filtering on the output of an LED driver is not recommended since it may inhibit optimal PWM dimming performance by slowing down PWM transitions and causing unwanted ringing. The low ripple, output-facing inductor yields the best combination of PWM dimming performance and low output EMI, like a buck. Note that the positive-to-negative single inductor buck-boost converter also has low output ripple and high bandwidth, but its input ripple and output ripple is notoriously coupled into large system input capacitance, creating larger than desired conducted EMI.

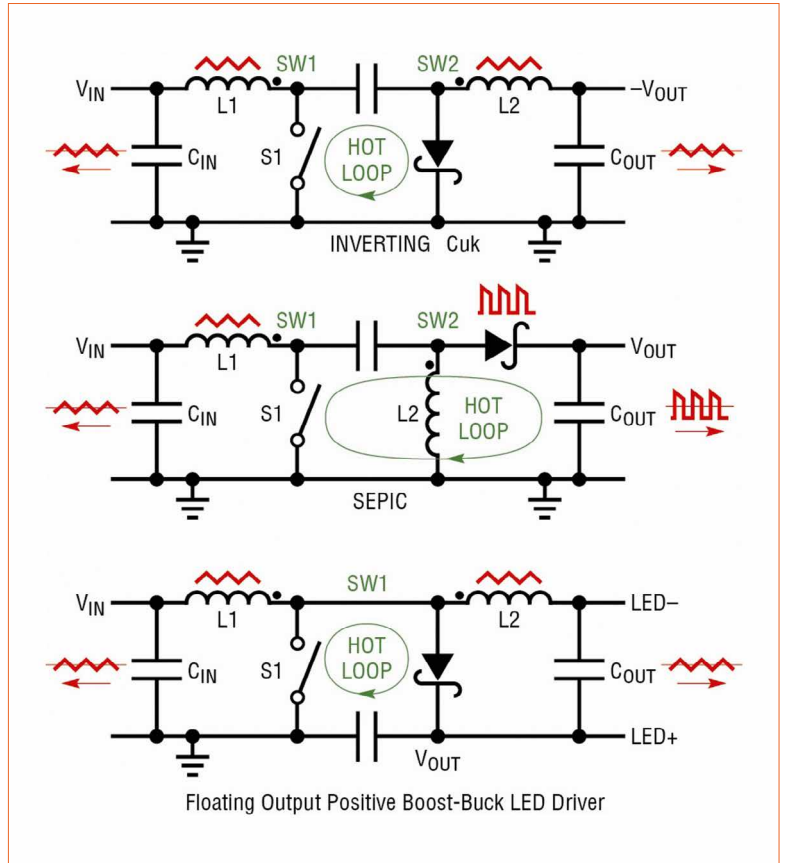
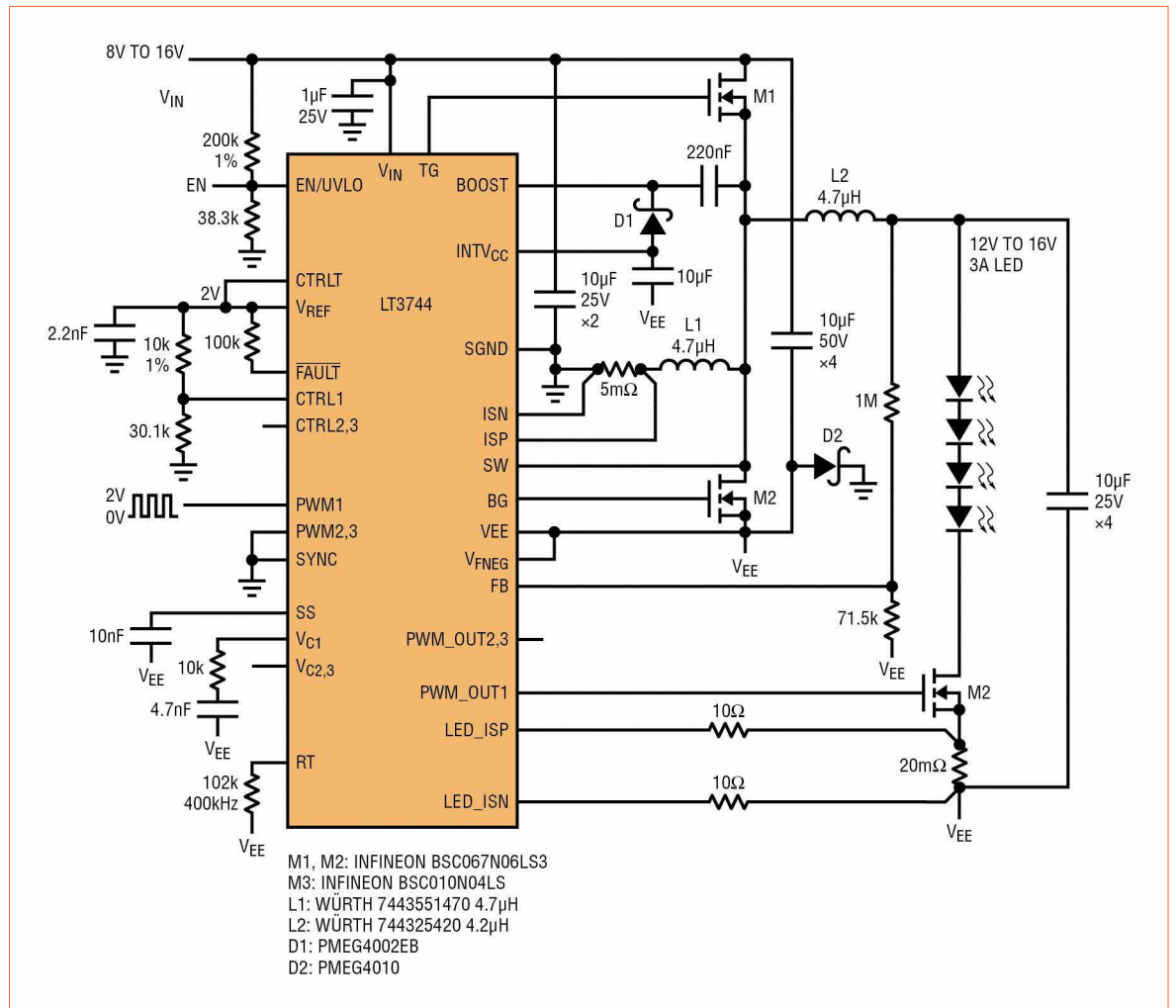

Figure 6:
A 9-16 V_{IN}, 18 V_{LED} 3 A positive-to-negative boost-buck LED driver has low input and low output ripple and high 93% efficiency at 48 W LED



Both the input and output capacitors in the boost-buck topology easily filter low triangular ripple current equal to

$$I_{Lpkpk} / \sqrt{12}$$

A bit more capacitance or inductance can further reduce EMI in this topology. Neither the input or output capacitor is crucial in the converter's high di/dt hot-loop. In this topology, the critical hot-loop is constrained to the catch diode, OUT-to-GND capacitor, and the internal low-side switch, as indicated in figure 5, simplifying the layout. When the two inductors or windings of the boost-buck are tied together and the LED- node is connected to the input, the boost-buck is converter back to a previously-used buck-boost mode converter. In this scenario, the hot-loop currents and the input and output ripple currents

can find their way onto the input and output capacitor alike, resulting in higher input and output ripple measurements.

Alternate Boost-Mode-Then-Buck Positive-to-Negative Topology is Similar

Yet another patent-pending boost-buck LED driver topology with low-ripple input and output is shown in figure 6 using the LT3744. The positive-to-negative boost-buck (boost-mode-then-buck) is also a low input and low output ripple LED driver, but instead using a synchronous step-down converter with negative regulation capability. This new floating negative output topology takes advantage of the strengths of a synchronous step-down LED driver with PWM and output flag level-shift capabilities. Mainly, high efficiency is

a major strength of a synchronous switching IC, especially when a high power LED string is driven such as the 3 A, 48 W LED load in figure 6. Synchronous step-up and down boost-buck LED drivers are possible with both synchronous boost and buck LED drivers.

Conclusion

The new, patent-pending boost-buck LED driver topologies provide step-up and step-down input to LED ratios with both low input ripple and output ripple. Appropriate LED drivers can be used for both simple and high power LED strings in automotive and industrial applications where high power and low noise are crucial without a sacrifice of PWM dimming performance. ■

Illuminating innovations.

More performance and design freedom

Dow Corning offers today's LED industry unmatched experience and know-how for LED lamp and luminaire assembly. We bring more than just an industry-leading portfolio of assembly and optics materials – we offer you solutions for maximizing performance and enabling next generation design. As your dedicated innovation partner, we also bring proven process and application expertise, a network of molding and optical experts, reliable global supply base and world-class customer service.



To learn how Dow Corning silicones can address your key performance issues and turn your next-generation concepts into reality, visit dowcorning.com/lighting.



Combining Technical and Financial Approaches to Risk Management

Due to the rapid pace of innovation, manufacturers, investors and end users in the solid-state lighting (SSL) market are exposed to an above-average level of risk. This raises the question how to minimize risk and improve confidence among investors and end users alike. Jacob Nuesink, Global Account Manager and Business Developer Lighting for DEKRA, Dr. Sebastian Scholz, Senior Business Development Manager, and Oliver Quast, Underwriter at Munich RE, propose a combination of testing, certification and insurance-based risk transfer to strengthen the reputation of the industry and to assist SMEs in the LED industry to gain market share.

Risk management is an important business success factor in any sector, but particularly so in the solid-state lighting (SSL) industry in view of the rapid pace of technological advancement. Nowadays, due to the pressure to reduce the time to market in order to stay competitive, development times for LEDs are down to 6 months or less and new luminaires are released in quick succession. This rush to introduce the next generation of lighting has had a negative effect on quality, which has, in turn, dented the reputation of the lighting industry as a whole. Furthermore, the market has seen a high number of new entrants in recent years, many of which lack sufficient experience, such as electronics companies that are new to lighting and lighting specialists without the necessary electronics expertise. Therefore, in order to improve the sector's image, it is important for manufacturers to demonstrate that they supply high-quality products.

Independent Verification

One way to positively increase brand recognition of small and medium-sized LED manufacturers (SMEs) and to bolster confidence of investors and end users of this relatively new technology is to thoroughly demonstrate that product quality has been objectively tested and certified by an independent third party. Consumer surveys consistently indicate that an impartial seal of approval can go a long way to increase adoption rates, particularly of a new technology like LED-based lighting.

The four main building blocks of any meaningful quality verification in this regard are:

- photometric characteristics (e.g. luminous flux, efficacy, color temperature, CRI)
- electrical characteristics (e.g. power factor, harmonic distortion, inrush currents)
- protection against environmental factors (e.g. ambient temperature range, IP rating, IK rating)
- lifetime (e.g. lumen maintenance, driver lifetime)

One independent verification method to market participants is the DEKRA LED Performance Mark. In order to obtain this certification, all of the above-mentioned parameters are tested and the findings are presented in a concise data sheet. The data sheet enables companies to boost their credibility by explaining their unique selling points based on objective evaluation against relevant standards rather than their own, in-house research which could be perceived as being biased. Furthermore, end users are able to make impartial comparisons and are reassured that the lighting products are safe to use in line with all applicable performance standards.

Inaccurate Projections

In the dynamic SSL industry, however, the standards do not always fully address market needs. Under pressure to launch quickly in order to minimize time to market, manufacturers might introduce new products based on potentially inaccurate long-term projections regarding useful life, simply because there has not been sufficient time to test the products' actual lifetime in practice and under 'real-life

conditions'. Beyond this, the most practical way to determine the lifetime of a luminaire is through a combination of testing the LEDs at chip or module level according to LM80 and the driver according to HAL testing. The results can then be used to determine the lifetime of the luminaire in the best possible way using TM21 and measurement of the conditions in the luminaire for the driver and module. Providing replacements for a batch of luminaires which fall short of the guaranteed performance achievements can be a costly and potentially reputation-damaging exercise for manufacturers. In the case of small and medium-sized companies, recent examples have shown that such an incident can even cause the manufacturer to go bankrupt. In turn, this presents a major challenge for investors trying to put an appropriate price on such risk, not to mention affecting the crucial end-user confidence which ultimately determines the mid- to long-term fate and therefore revenue of the LED industry.

Insuring Against Technological Risks and Their Financial Impact

To assist the LED market, Munich RE Corporate Insurance Partner has developed a suite of innovative risk-transfer solutions which can complement the DEKRA LED Performance Mark. This cover, which can be fully customized in order to provide business-enabling risk transfer depending on a very specific manufacturer demand, can address LED performance issues like lumen output and color consistency. Particularly, the past couple of months have shown that the LED market consolidation is clearly driving demand for this type of tailored risk transfer due to the aforementioned challenges facing the industry. LED manufacturers have reported that these non-standardized insurance solutions are particularly effective in securing a broader investment base for LED manufacturers and decreasing the financing costs charged by

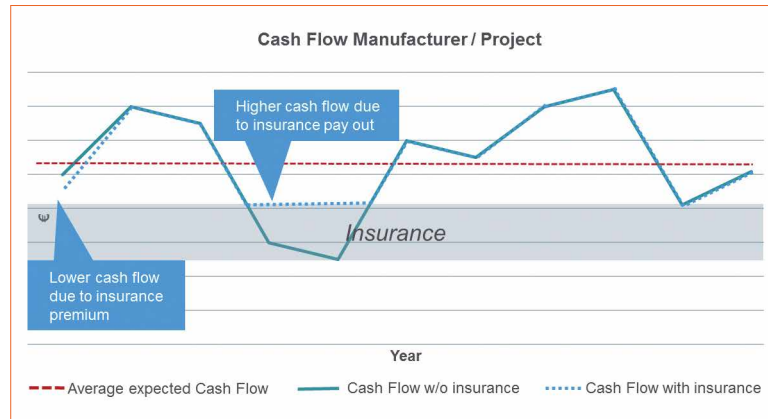

Figure 1: The grey area shows the reduced downside cash flow volatility of a manufacturer or LED investment due to a bespoke risk-transfer solution. Note that such a solution does not cover entrepreneurial risk, i.e. average expected cash flow

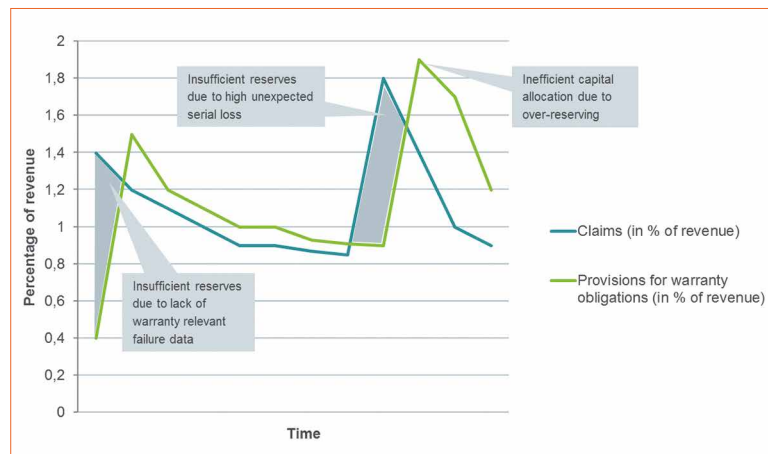



Figure 2: LED risk-transfer solutions hedge against liquidity bottlenecks caused by technology failure / serial loss as well as inefficient capital allocation due to over-reserving



Basis: Insurance of entire LED production Insured: LED Manufacturer

Warranty obligations for all LED products of a certain product line are automatically covered.



Option: Insurance of LED retrofit projects Insured: Project Owner/ESCO

Products that are specifically produced for large projects (e.g. cars parks, ports, industrial lighting, streetlight) are covered, in case the manufacturer is unable to fulfill warranty obligations.

Figure 3: Two basic principles of LED risk-transfer solutions for manufacturers and large investment projects

investors. Furthermore, they allow a manufacturer to allocate capital to growth-enabling R&D more flexibly, rather than having to reserve it for potential warranty claims.

The way these 'corporate cover' solutions work is essentially by providing warranty performance cover for LED manufacturers. Manufacturers can insure themselves against having to fulfill excessive warranty claims for products which are still under guarantee. This means that the

manufacturer needs to make lower balance-sheet provisions for such liabilities, which improves the company's liquidity and hence financial outlook.

Furthermore, in the unfortunate event of a manufacturer's insolvency, another solution (the so-called 'option cover') indemnifies for warranty claims against the manufacturer, thus providing peace of mind for investors and end customers alike.

The risk assessment procedure leading to both the corporate as well as the project-related cover usually entails a very extensive study of all processes and products of potential new insurance customers. It is particularly this latter point where the recently announced cooperation has a substantial potential upside for customers in the LED field. Thanks to alignment between the due diligences process for Munich RE's LED risk-transfer solutions and the data requirements of the LED Performance Mark, the inspection and test results can form the basis for the underwriting of the performance warranty cover. As a consequence, manufacturers who hold this LED Performance Mark undergo a streamlined due diligence process for LED performance guarantee solutions and hence are able to save a considerable amount of time and effort.

In addition, the complementary nature of the certification's technical product and process evaluation expertise and risk-transfer capacity adds significant value for manufacturers and investors who are keen to insure against financial risks in this relatively new and rapidly consolidating industry. Both DEKRA Certification and Munich RE retain full control over their own areas of expertise and no commission or other financial arrangement is involved whatsoever. The sole aim of this new partnership is to collaborate and use synergies in the best interest of the entire LED industry. It is a sector that holds great promise, not only in terms of more efficient lighting but also as a key player driving the 'efficiency revolution' needed to achieve the globally required reductions in greenhouse gas emissions.

Equal Footing

Collaborative partnerships of this kind, which bring together the technical and financial aspects of enterprise risk management, can help to dramatically improve investor confidence due to the strong complementary value proposition offered. Small and medium-sized LED manufacturers, in particular, stand to benefit since independent certification and risk transfer can position them on an equal footing with larger competitors. Ultimately, the LED industry as a whole will profit from increased diversification and guaranteed performance quality. ■

References:

<http://www.munichre.com/corporate-insurance-partner/en/homepage/index.html> www.dekra-certification.com



LT Series Aging-Life Test System for LED Luminaries

LT Series Aging-life Test System is widely used for normal/accelerated aging, lumen maintenance and color shift measurement, lifetime evaluation and temperature characteristic test for LED packages, modules, lamps and luminaires. The referenced standards include: IES LM-80, IES LM-82, IES LM-84, IES TM-21, TM-26, IEC 62612, IEC 62722, and more. It has been widely applied in NVLAP accredited laboratories.

EVERFINE Corp. | E-mail: global@everfine.net | www.everfine.net

EVERFINE 远方



LYON – FRANCE
CITÉ CENTRE DES CONGRÈS

Register online: www.forumled.com
Your PROMOTIONAL Code : LEDPR010
Your Free Acces Badge to visit Exhibition
+
10% Discount Rate
for registration to conferences

07 & 08 DECEMBER 2015
CONGRESS & EXPO

LEDs: Technologies,
Products and Systems

The biggest event
on LED lighting in Europe
GET CONNECTED !

Contact / Informations

Laurent Gitenet

Phone : +33 (0)4 37 40 31 65

Email : info@forumled.com

www.forumled.com



LED professional Review (LpR) - Annual Subscriptions

LpR Digital Magazine

- 6 issues
- pdf download
- high resolution pictures and graphs
- printable
- commercial use
- access to all previous issues
- Euro 78.80

LpR Printed Magazine

- 6 issues
- Euro 158.40

<http://www.led-professional.com/subscription>

Cover-page

Artwork: Thomas Klobassa,
©LED professional 2015

Main Image: Arno Grabher-Meyer,
LED professional

Product: PLEXIGLAS® WH



New EVONIK "integrated light guide material" for side coupling at LpS 2015

Next LpR LIGHT QUALITY, HCL & ENVIRONMENT Issue 53 - Jan/Feb 2016 - Short Overview

TRENDS

Embedded Lighting - Developing New Lighting Applications for Modern Architectural Projects

Many architects and interior designers have a difficult time understanding the potential for new applications of light permitted by LED technologies. The author shows how embedded lighting breaks through the tired paradigms of light bulbs and light fixtures and opens up exciting new opportunities for both the design and delivery of architectural lighting systems. ■

TECHNOLOGIES

Light Flicker from LED Lighting Systems - An Urgent Problem to Solve

Flicker is the modulation of a lamp's light output caused by fluctuations of the mains voltage supply. Recent research has showed that fluctuations of short wavelength emissions are perceived to a higher extent and light flicker may have a huge influence on the well-being of end users. Research results and the influence of driver topologies will be presented and discussed. ■

The Role of Special Optics in Human Centric Lighting and Architecture

While Human Centric Lighting is relatively new and a topic of some debate, few can argue over the benefits of creating more natural lighting conditions in offices, retail spaces and other architectural settings. The article shows how special or "tertiary" optics such as diffusers and direction turning film can play a crucial role in Human Centric Lighting or lighting that takes into account the emotional and biological needs of humans. ■

RESEARCH

"Best Papers" at LpS 2015: Human-Focused Outdoor Illumination - A Trade-Off Between Pleasing Color and Circadian Action

A multitude of general studies were performed in order to confirm or deny the Kruithof predictions of the regions of illuminance levels and color temperatures that are perceived by the observer as „pleasing“. This study researches preferences for outdoor environments for which practically no scientific evidence exists that support the Kruithof predictions. ■

White Hybrid LEDs - a Perspective on Commercialization and Health Aspects

One of the challenges in terms of commercialization of white LEDs is the need for cheap, inorganic phosphors. In this context, hybrid LEDs have recently emerged as a new approach based on down-converting organic coatings. The authors describe this technology and cover recent breakthroughs and their prospects. ■

subject to change

Imprint

LED professional Review (LpR), ISSN 1993-890X

Publishing Company

Luger Research e.U.

Institute for Innovation & Technology
Moosmahdstrasse 30
A 6850 Dornbirn, Austria / Europe
phone +43 5572 39 44 89
fax +43 5572 20 60 70
info(at)lugerresearch.com
www.lugerresearch.com

Publisher

Siegfried Luger +43 699 11 33 55 70
s.luger(at)led-professional.com

Editor-in-Chief

Arno Grabher-Meyer +43 699 11 33 55 18
a.g-m(at)led-professional.com

Int. Account Manager

Theresa Koenig +43 699 11 33 55 20
theresa.koenig(at)led-professional.com

Marketing & Sales Manager

Katharina Fink +43 699 11 33 43 43
katharina.fink(at)led-professional.com

Your Local Contacts

China, Hong-Kong

Iris Yuen +86 1380 27 01 367
irisyuen88(at)gmail.com

Germany

Armin Wezel +49 30 526 891 92
armin(at)eurokom-media.de

India

Sudhanshu Shekhar +91 22 4127 9682
sudhanshus(at)binarysemantics.com

Japan

Eiji Yoshikawa +81 3 6751 0090
scala(at)s3.dion.ne.jp

South Korea

Jung Won Suh +82 2 78 58 222
sinsegi-2(at)sinsegi-media.info

Switzerland

Monika B. Ailingner +41 41 850 44 24
m.ailingner(at)marcomedia.ch

Taiwan

Leon Chen +886 2 256 81 786-10
leon(at)jkmedia.com.tw

United Kingdom, France & Benelux

Zena Coupé +44 1923 85 25 37
zena(at)expomedia.biz

US East

Karen C Smith-Kernc +1 717 397 7100
KarenKCS(at)aol.com

US West & Canada

Alan A. Kernc +1 717 397 7100
AlanKCS(at)aol.com

Copyrights - Luger Research e.U.

The editors make every reasonable effort to verify the information published, but Luger Research e.U. assumes no responsibility for the validity of any manufacturers, non profit organisations or individuals claims or statements.

Luger Research e.U. does not assume and hereby disclaims any liability to any person for any loss or damage caused by errors or omissions in the material contained herein, regardless of whether such errors result from negligence, accident or any other cause whatsoever. You may not copy, reproduce, republish, download, post, broadcast, transmit, make available to the public, or otherwise use LED professional Review (LpR) content without prior written consent from Luger Research e.U. - Institute for Innovation & Technology, Austria. ■



! GET YOUR FREE E-MAGAZINE
www.led-professional.com/free



Trends & Technologies for Future Lighting Solutions.

LEDs • OLEDs • Light Engines • Lighting Modules • Optics • Drivers • Thermal Management • Lamps • Fixtures • Production & Measurement Equipment
Project Reports • Patent Reports • Research Reports • Event Reports

LED
professional

MORE THAN
25,500
READERS

www.led-professional.com

powered by Luger Research e.U.

Submit your article. Please contact Arno Grabher-Meyer, Editor in Chief, at a.g-m@led-professional.com

NEW CREE® XLAMP® LEDs CAN:

IMPROVE RELIABILITY ::

REDUCE SYSTEM COST ::

REDEFINE LED LIGHTING ::

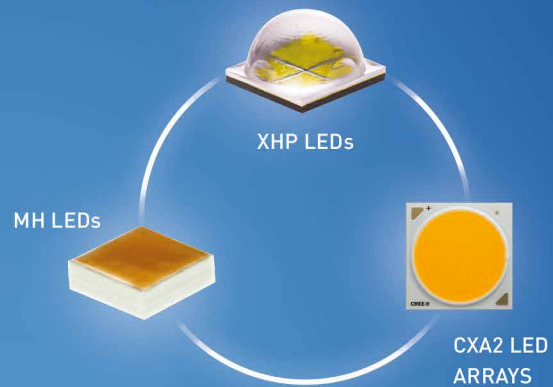

GAME CHANGING IS GREAT. BOTTOM LINE CHANGING IS BETTER.

You can't change your bottom line by using the same LEDs that everyone else is using. Cree's Extreme High Power (XHP) LEDs deliver double the lumen output at high operating temperatures, while our MH LEDs combine the system advantages of our best arrays with the manufacturing ease of a discrete. And our CXA2 LED arrays are packed with lumens to offer system cost savings up to 60%.

CREE 

See how higher power equals lower cost.
cree.com/xhp

The new way to a better LED array.
cree.com/mh

Even more lumens for savings up to 60%.
cree.com/cxa2