



Research: Lifetime Calculation

Events: LuxLive & Swiss Photonics

Technology & Application: Microscopy & Cave Lighting

Usability: User Interface UI & UX

UPDATED VERSION 1.1 AVAILABLE  
DESIGN YOUR LUMINAIRE NOW!  
<http://www1.FutureLightingSolutions.com/LSC>

# Exclusive. Extraordinary. FREE.

## Over 20,000 Lighting Simulations Completed with Future Lighting Solutions' Lighting System Creator Design Tool

The Lighting System Creator is a free online design tool offered by Future Lighting Solutions which enables the user to seamlessly create an entire lighting system. Powered by a proprietary algorithm leveraging light source LM-80 data, the LSC automatically provides appropriate and application specific light sources based on value engineering principles, determines the optimal forward current and temperature to meet target flux, efficacy and L70 lumen maintenance values.

- The LSC will optimize the temperature and current to minimize the LED count and suggest the most cost effective approach to meet target specifications using LEDs, COBs, and even modules and integrated light engines.
- In cases where the user wishes to consider one specific type of light-source for the application, the user can now specifically select their preference versus being presented with all possible technical solutions.
- The LSC now also includes light sources that do not yet have an available LM-80 report. This now enables users to consider recently released products for design consideration in to their fixtures.
- The tool also includes an automatic offset that incorporates the efficiency impact of the integrated driver and/or integrated optic for modules and light engines when applicable.

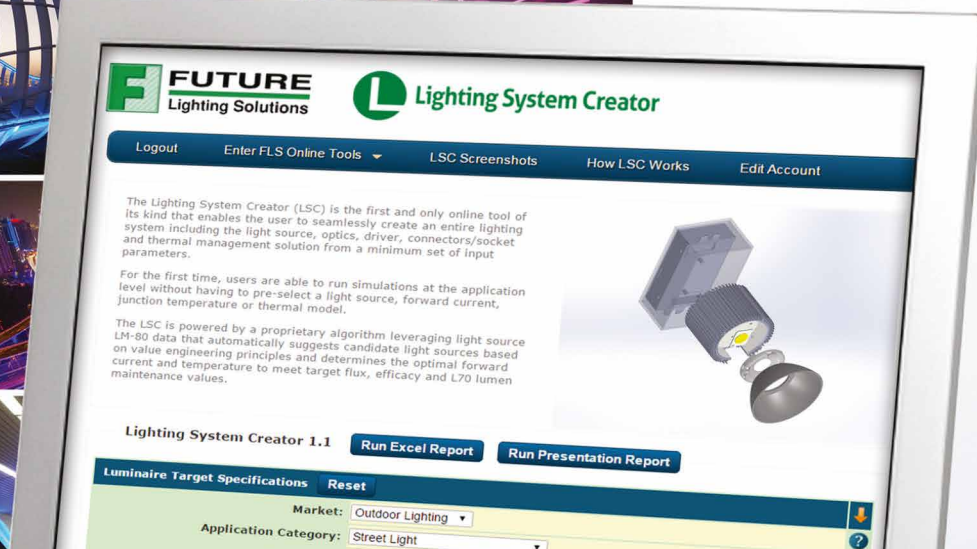
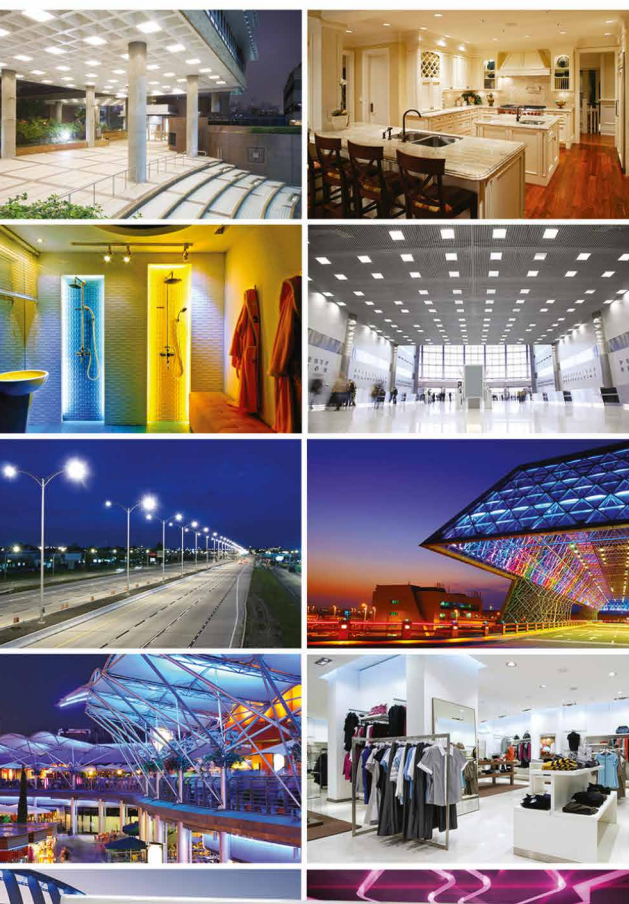

**FUTURE**  
Lighting Solutions  
Making LED Lighting Solutions Simple™  
[www.FutureLightingSolutions.com](http://www.FutureLightingSolutions.com)

# Illumination - Innovation - Imagination

## Philips Fortimo LED Module System Solutions



### LED Strip

Enabling design of high-performance slim linear LED luminaires, not possible with fluorescent lighting or Fortimo LED Line.

### LED Line High Flux High Temperature

Ideal for application at elevated installation heights and increased application temperatures where more light is needed, such as trunking, battens, high-bay applications.

### LED Line

Designed to replace fluorescent lighting in new luminaires for general lighting applications in office, retail, and industry.

### LED Line Value Offer (VO)

Enabling most economic fixture design meeting DLC requirements for linear LED applications like troffers replacing T8 lamp equivalents.

### LED Strip, LED Lines

#### High-end OEM's being able to sell TCO in projects

Exceptional quality of light

- High color rendering (CRI >80 and >90)
- Excellent color consistency of 3 SDCM
- High homogeneity with low LED pitch (no pixilation)

Highest design flexibility

- Slim width <= 20mm
- Shorter lengths

Highest energy efficiency and lifetime

- State-of-the-art efficiency greater than 170 lm/W
- Life-time: up to >50,000 hours at high Tc life (up to Five year system warranty)

### VO Boards Economic, Quality and Value

#### Enable luminaires for high volume markets

Good quality of light

- Color rendering (CRI >80 )
- Color consistency of 3.5 SDCM

Essential product performance and functionality

- Efficiency up to 141 lm/W
- Life-time: up to >50,000 hours

Five year system warranty

For the latest information on Philips products contact your local FLS sales representative.

This information is accurate at the time of writing. Neither Philips nor its agents assume any liability for inaccuracies or losses incurred by use or misuse of this information. Check manufacturer's website for the most recent information.

**PHILIPS**

Authorized Distributor

**FUTURE**  
Lighting Solutions  
*Making LED Lighting Solutions Simple™*

[www.FutureLightingSolutions.com](http://www.FutureLightingSolutions.com)



# Lights in Trendy Environments

Recently Apple celebrated iPhone's 10-year anniversary with overall sales of about one billion phones. The goal of Apple manufacturer, Foxconn, is to completely replace humans with robots and their three-part plan shows that by 2020 they will have reached 30% automation. In the meantime, some Foxconn factories in China already have 10 fully automated production lines.

Some of the trends seen at the Consumer Electronics Show (CES) in Las Vegas were things like self-driving cars, flying cards, vibrating pants, robots, smart beds and lots of shiny new technologies. LG, for example, presented their "Wallpaper TV". This is a Signature 65 or 77-inch OLED TV W with a four-millimeter flexible screen, able to hang on the wall with magnets.

The German automotive company, ZF, has partnered with NVIDIA to create ProAI, a deep-learning artificial intelligence program that takes a huge step toward intellectualizing our vehicles. The ZF ProAI will be able to process input from multiple cameras, plus lidar, radar and ultrasonic sensors in a process that they call "sensor fusion", generating a 360-degree sensory sphere for the vehicle.

Electric cars were also presented: a concept car from Bosch and the new FF91 from Faraday Future, a fully connected, self-driving car with a 1,050 HP engine that can go from 0 to 60 mph in 2.39 seconds. It also includes a smartphone-operated "driverless valet" that parks the car for you.

Spinali Design presented their vibrating short-shorts, which sync with your phone and translate directions from your favorite navigation app into goading twitches on your left or right cheeks.

We recently experienced intelligent light bulbs that can be connected via WLAN and a bridge to smartphones and then be controlled by voice commands that worked perfectly. It is also possible to automate the lighting, control it from afar via the Internet and adjust the color and brightness.

When looking at all these developments it is easy to expect that lighting production will also become fully automated, surrounded by sensor-fusions, self-controlled, connected to the Internet, adapted to the needs of individuals and available in nearly all the dimensions and specifications we can think of. The developments we see in our environment will not stop at lighting, though. Our environments will be completely penetrated with these new trends and AI lighting will be the main way to go.

The first issue of LpR in 2017 deals with some of these trendy topics for lighting. There are also reviews of lighting events that will be of interest to you.

I would also like to mention that the LpS 2017 is the place to exchange information about the future of lighting technologies and applications. Take advantage of it by submitting your paper to be reviewed for a talk by following this link: [www.LpS2017.com/cfp](http://www.LpS2017.com/cfp). We look forward to exchanging ideas about the future of lighting with you.

Yours Sincerely,



Siegfried Luger  
 Publisher, LED professional  
 Event Director, LpS 2017

# Small is Big

For Manual and  
Automated Wiring Systems  
**2060**

For Direct  
Power System Feed-In  
**2061**

For the  
Smallest Sizes  
**2059**



**297** For Vertical  
Wiring

**2065** Reduced to  
the Essentials

The Range of  
SMD Terminal Blocks

[www.wago.com/smd](http://www.wago.com/smd)

**WE  
INNOVATE!**

**WAGO**

COMMENTARY

08 Lighting Up Smart Cities  
by Dr. Wu Chou, Huawei

TECH-TALKS BREGENZ

28 Dr. Rubén D. Costa, Group Leader, University of Erlangen-Nuremberg  
compiled by Dr. Günther Sejkora, LED professional

RESEARCH

34 Lifetime Calculation of White HP-LEDs from 16,000 Hours Aging Data  
by Max Wagner et al., TU Darmstadt

EVENTS

40 LuxLive and SILE Sharpen Focus on End-Users  
by Arno Grabher-Meyer, LED professional

44 Swiss Photonics Workshop on Intelligent Efficient Solid State Lighting  
by Arno Grabher-Meyer, LED professional

TECHNOLOGIES

50 Thermal Management of an LED Light Source for Microscopes  
by Wolfgang Plank & Gerd Harder, ESCATEC

USABILITY

54 Enhancing the LED Experience - UI & UX as Success Factors  
for IoT Based Lighting Controls  
by Karl Jónsson & Christian Moormann, Tridonic

APPLICATION

58 Technical Aspects Regarding the Equipment of Show Caves  
with Modern LED Systems  
by Vladimir Vashkevich, Cave Lighting CL GmbH & Co KG

68 ARTICLE INDEX 2016

REGULARS

04 EDITORIAL  
08 COMMENTARY  
10 PRODUCT NEWS  
21 RESEARCH NEWS  
22 REGULATION NEWS  
24 CIE RESEARCH

70 ABOUT | IMPRINT

HIGHLIGHT

58 Technical Aspects Regarding the  
Equipment of Show Caves  
with Modern LED Systems  
Vladimir Vashkevich, Cave Lighting  
CL GmbH & Co KG



ADVERTISING INDEX

FUTURE LIGHTING SOLUTIONS	1	FULHAM	19	INFINEON	48
FUTURE LIGHTING SOLUTIONS	2	CREE	20	MEGAMAN - TECOH	49
FLS-PHILIPS	3	REFOND	21	IMOS GUBELA	57
WAGO	5	TILS	23	LED LIGHTING TAIWAN	65
CREE	7	GRE ALPHA ELECTRONICS	33	GUANGZHOU INT. LIGHTING EXHIBITION	67
LEDFRIEND	9	EPISTAR	33	LED PROFESSIONAL REVIEW	71
SEOUL SEMICONDUCTOR	13	LED PROFESSIONAL SYMPOSIUM	35	ACEVEL	72
HONGLI ZHIHUI GROUP	15	FLS-NICHIA	39		
INSTRUMENT SYSTEMS	17	INTERLUMI PANAMA 2017	43		

**NEW CREE® XLAMP® LEDs CAN:**

*IMPROVE RELIABILITY ::*

*REDUCE SYSTEM COST ::*

*REDEFINE LED LIGHTING ::*

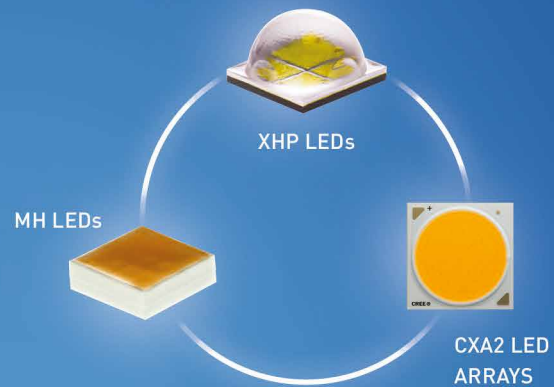

# GAME CHANGING IS GREAT. BOTTOM LINE CHANGING IS BETTER.

You can't change your bottom line by using the same LEDs that everyone else is using. Cree's Extreme High Power (XHP) LEDs deliver double the lumen output at high operating temperatures, while our MH LEDs combine the system advantages of our best arrays with the manufacturing ease of a discrete. And our CXA2 LED arrays are packed with lumens to offer system cost savings up to 60%.

**CREE** 

See how higher power equals lower cost.  
[cree.com/xhp](http://cree.com/xhp)

The new way to a better LED array.  
[cree.com/mh](http://cree.com/mh)

Even more lumens for savings up to 60%.  
[cree.com/cxa2](http://cree.com/cxa2)



### Dr. Wu Chou

Dr. Chou received his Ph.D in Electrical Engineering from Stanford University. He worked for Bell Labs (AT&T/Lucent), Avaya, and joined Huawei in 2011 as Chief IT Scientist and head of Huawei Shannon (IT) Lab. He became the CTO of the Enterprise Network Product Line in 2015. He has published over 200 journal and conference papers and holds more than 40 US and international patents. Dr. Chou is an IEEE Fellow and worked as an editor and area expert for multiple standard bodies like ISO, W3C, ECMA and ETSI. He has also served as an editor for IEEE Transactions (C, AL) IEEE TSC Special Issue on Cloud computing, IEEE Transactions Special Issue on Human-machine Interaction. In addition to all that, Dr. Chou has served as a member of multiple advisory boards like that of MIT Computer Science and Artificial Intelligence Lab (CSAIL) Big Data Program and the New Jersey Institute of Technology (NJIT).

## LIGHTING UP SMART CITIES

Although streetlights have been associated with cities for more than a thousand years, they are rarely considered for functions other than luminary purposes. One of the distinct features of streetlights is their geographic location. In particular, streetlights follow the roads and streets that are the arteries of the city, and at night they outline the city so it can be seen from many miles away.

As global urbanization trends continue, more people will move to the city. It is estimated that by the year 2050 more than 75% of the world population will live in cities. As a result, more streetlights will be needed to keep pace with expansion of a city and to provide ubiquitous lighting coverage for the population. The first challenge will be the huge amount of energy consumption. Street lighting consumes a good part of the 19% of power currently used for all lighting with a carbon footprint corresponding to burning billions of trees. Saving power for lighting has been an inspiration for technical advances and innovations and we have been advancing rapidly from incandescent, fluorescent, and high-pressure sodium lights to LED lighting.

There is also a strong demand for better and smarter cities with high quality and intelligent services. Similar to the advancement of lighting, technical advances and innovations have led to the era of Internet-of-Things (IoT) to enable smart cities. One fundamental feature of IoT is to connect the digital world, such as Internet, with the physical world, such as sensors, cars and lights. IoT offers tremendous opportunities for new services with improved efficiency and intelligence including street lighting.

In fact, the combination of IoT + LED lighting opens a new paradigm in street lighting. A fully connected lighting network offers more intelligent lighting control through which a reduction of energy consumption of up to 80% as well as cost reductions in

operation can be achieved. The light can be dimmed and lit up instantly depending on the needs and the energy saving policy/algorithm being deployed. By integrating a GIS (geographic information module) component that provides precise geographic information, the status and well being of every single LED light can also be monitored. This information can be used to monitor the operation status, but also for (predictive) maintenance needs. Operation costs can be reduced by up to 90% while significantly lowering the down time of the light and improving the service quality and user experience.

It is a huge challenge to construct an IoT platform with good coverage of the city, but the emergence of IoT+LED based connected street lighting can work miraculously for smart cities. In addition to an IoT gateway connection, streetlights can be interconnected through an RF mesh network (e.g. 6LowPAN: IPv6 over low power wireless area network). This RF mesh network is extensible and ad hoc with self-healing capabilities. Today, more than 30 types of sensors can be deployed on this connected street lighting IoT platform for smart city services, including environmental services (air quality, traffic flow, etc.), city parking, garbage bin and manhole monitoring, security, etc.

Furthermore, a fully connected street lighting IoT platform makes the lighting poles increasingly valuable. They can be used for WiFi or small cell stations to provide wireless coverage of the city, for roadside charging of electrical cars, and even for advertisement applications with LED displays that can be mounted on the poles. As we enter the era of IoT, these applications are just the tip of the iceberg that the IoT+LED based connected street lighting IoT platform can provide. But most importantly, IoT+LED has become reality for lighting up smart cities. ■

W.C.





Strategies In Light 2017  
Feb. 28-March 2  
Anaheim CA, USA  
**Booth # 702**

**Features:**

- \* Lifud LF-GIR\*\*\*YM/YN/YS series;
- \* IP20/ flicker-free version/ typical version;
- \* 5-63W / 220-240Vac, 25-42Vdc, 120-1500mA;
- \* Meet ERP standard;
- \* Applied for LED panels, down lights etc;
- \* CE CB RCM TUV
- \* 3 years warranty, 5yrs and 10yrs versions are still available;

**Features:**

- \* Lifud LF-GLD series;
- \* IP65/ flicker-free/ 0-10V,PWM and Rx dimmable;
- \* 15-60W / 100-277Vac, 25-50Vdc, 300-1500mA;
- \* Meet ERP/ ClassI/ Class II standard;
- \* Applied for tri-proof lights, floodlights, plant-growth lights;
- \* UL FCC
- \* 5 years warranty



## More new products

New Lifud Emergency driver( all in one design) + Non-isolated linear metal case design+ Triac dimmable+ DALI Push. . .



Shenzhen Ledfriend Optoelectronics Co., Ltd ( Headquarters)  
Sichuan Ledfriend Technology Co., Ltd ( Production Base)  
[www.lifud.com](http://www.lifud.com)  
[sales@ledfriend.com](mailto:sales@ledfriend.com)  
**Come on, LED friends!**



Website in English

## Cree Announces the Next Generation XHP50.2 LEDs

Cree introduces the XLamp® XHP50.2 LED, which delivers up to seven percent more lumens and 10 percent higher lumens-per-watt (LPW) than the first generation XHP50 LED in the same 5.0 mm x 5.0 mm package. The new XHP50.2 LED enables lighting manufacturers to quickly improve the performance of existing XHP50 lighting designs. Capable of producing more than 2,500 lumens from its 6mm light emitting surface (LES), the XHP50.2 can reduce the size and cost of new designs and enable innovative solutions to address applications ranging from spot to street lighting.



**Cree's new XHP50.2 LED delivers the highest lumen density in its class**

"Arianna shares Cree's vision that LEDs should not compromise quality or performance and should provide better lighting experiences in all aspects," said Lorenzo Trevisanello, R&D manager of Arianna. "Our goals are to achieve the best cost-efficacy and versatility using the most efficient LEDs. Thanks to the XHP50.2 LED's lumen density and proven reliability, even at high operating temperatures and drive currents, we are able to push the performance and size boundaries of our products even further."

In addition to light output and efficacy enhancements, the XHP50.2 LED provides improvements to optical uniformity through secondary optics, enabling spot and portable lighting manufacturers to deliver better lighting experiences. The XHP50.2 LED has LM-80 data available immediately, reducing the time required to receive ENERGY STAR® and DesignLights Consortium® qualifications.

"Cree redefined High Power LED performance with the introduction of the industry's first Extreme High Power LEDs,"

said Dave Emerson, senior vice president and general manager for Cree LEDs. "Delivering the industry's best lumen density and reliability, Cree's XHP LED family allows our customers to achieve performance levels not possible with other LEDs at the lowest total system cost in a wide range of applications. With the launch of XHP50.2, Cree continues to redefine what is possible with high performance LEDs."

Featuring Cree's EasyWhite® technology, which provides the industry's best color consistency, the XLamp XHP50.2 LEDs are available in 2700-6500 K with high CRI options. Product samples are available now, and production quantities are available with standard lead times. ■

## Luxeon UV U1 Doubles Performance of Industry's Smallest UV Emitter

Leveraging its leading expertise in chip scale packaging, Lumileds introduced the Luxeon UV U1 LED for use in UV curing, counterfeit detection, analytical instrumentation, inspections and other UVA and Violet (380-420 nm) applications. This third generation of UV LEDs maintains the same micro package size as Luxeon Z UV, but enables a higher power density.

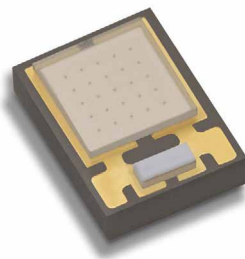

**The Luxeon UV U1 delivers twice the irradiance power of the previous generation UV LED at 380-390 nm in a miniature 2.2 mm<sup>2</sup> SMD package with a 5x greater power density**

Luxeon UV U1 features a robust design that eliminates materials like silicone over mold, which tends to yellow and crack upon UV exposure, and the elimination of wire bonds that can lead to catastrophic connection failures. "UV LED customers are reliability driven. They tend to run their equipment 24/7 and demand a proven product that will perform as expected for over 20,000 hours. The Luxeon UV U1 is that reliable product," said Yan Chai, Product Line Director of Lumileds UV LEDs.

The Luxeon UV U1 LED is nominally tested at 500mA but can be driven at up to 1A to achieve higher irradiances. For the application of UV curing at 395 nm, Luxeon UV U1 achieves 700 mW at 500 mA and >1300 mW at 1 A under 25°C. Compared to the 3.5x3.5 mm<sup>2</sup> package size of most UV LEDs, Luxeon UV U1's unique micro package size delivers superior packing density as well as >5x higher power density.

The Luxeon UV U1's footprint is a drop-in replacement for the Luxeon Z UV, while providing twice the typical radiometric power as its predecessor at 380-390 nm, a popular range for UV curing applications. The surface mount LEDs can be tightly assembled with spacing as small as 200 µm for high system flux density. With a wall plug efficiency exceeding 45+% and thermal management aided by an AlN package, users can avoid the use of more expensive water cooling at the system level. ■

## Epileds and HPL Jointly Launched the Bioraytron Brand UVC LED Products

Bioraytron is a 50/50 joint venture by Epileds and HPL. The epi wafers and chips of UVC LED are manufactured by Epileds, and packages and modules being exclusively sold under the brand name of Bioraytron are completed by HPL.

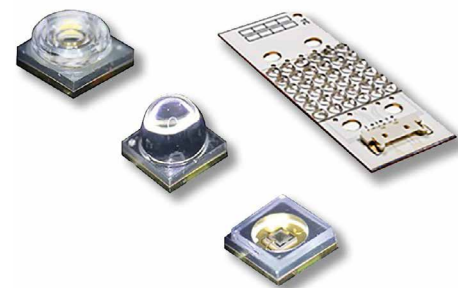

**Epileds and HPL jointly launched Bioraytron UVC LED Products offer an irradiance > 25 mW/cm<sup>2</sup> in wavelength of 265-275 nm**

Bioraytron UVC LED products including single component and COB with copper or aluminum nitride as the cooling substrates, with high-purified quartz optical lens, and the most effectiveness of air, surface and water sterilization wavelength in the range of 265-275 nm, emit the world's highest irradiance output of greater than 25 mW/cm<sup>2</sup> at 10mm working distance and 1.2 W input

power. This technology gives customers more freedom of product design and effectively shorten sterilization time.

Currently, Bioraytron UVC LED packaging products have reached a sweet point at USD 1-4 / mW and probably even lower in the coming years, and it is expected that UVC LED market demands rapid growth into the consumer industries, including home appliances, food processing, sanitary and kitchen wares and 3C products in 2017; the medical sterilization and medical testing equipment-related industry will be focused by 2018 and proceeding to 2019, it will be cut into the industrial and high-tech water sterilization industry.

Epileds and HPL taking advantage of Taiwan UVC LED vertically integrated supply chain, will accelerate the global market popularity of UVC deep ultraviolet ray sterilization. ■

## Sharp Updates and Expands Their Popular Natural Toning Zenigata

Sharp Devices Europe (SDE) has launched the second generation of its Natural Toning Zenigata COB LEDs, which warm as they are dimmed. The new models offer an expanded CCT range and enhanced energy efficiency.

**[Dim-to-warm from a single light emitting surface]**

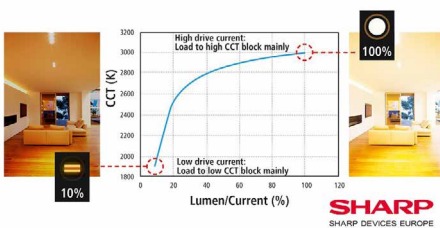

**Sharp's three natural toning Zenigata LED models including a new 6 mm LES version**

Available in the popular Mini Zenigata footprint, Natural Toning technology automatically tunes the color temperature from 3000K down to as low as 1900K as the LED is dimmed. This mimics the behavior of conventional incandescent sources, which is desirable, for instance, in hospitality and retail applications. Natural Toning Zenigata COBs require no special control electronics; a standard amplitude-dimming driver is all that's required, making them easy to integrate and simple to operate.

### Outstanding color quality:

Natural Toning LEDs from Sharp provide outstanding color quality, with typical CRIs ranging between 92 and 94 across the dimming range. Warm white and cool white blocks are combined within a single light emitting surface, ensuring uniform color distribution without the complexity of RGB-array solutions. The spectral fidelity and color gamut of Natural Toning COBs results in a near perfect reproduction of halogen lamp behavior.

### Toning things down:

The positive reception that the first generation of Natural Toning LEDs experienced has allowed Sharp Devices Europe to gather feedback on customer preferences. In response, the color range of second-generation Natural Toning COB LEDs was adjusted accordingly. After the modification, the warm end is warmer; with output now ranging from 1900 K to 3000 K. Efficiency has increased to more than 90 lumens per watt. There is also a new model with a 6 mm LES that produces a very narrow light beam.

### Availability:

Second-generation Natural Toning Mini Zenigata LEDs are available immediately. Thanks to their single drive circuit with just one pair of terminals, they reduce design complexity and installation costs for dim-to-warm applications. ■

## Osram Adds New Oslon Black Flat S to Its Automotive Portfolio

Osram Opto Semiconductors has launched the Oslon Black Flat S series, the world's first surface mountable LEDs with up to five individually controllable chips. Thanks also to the contrast ratio provided by the package, they are predestined for use in ADB (Adaptive Driving Beam) headlights. Switchable light segments enable oncoming traffic and traffic further ahead on the road to be masked out, making driving more comfortable and safer. With their improved thermal properties, these high-power LEDs offer system benefits and are suitable as an attractive entry-level ADB solution even for vehicles in the compact class. The new 3-chip version in the Oslon Black Flat S series has been available since October 2016, and the versions with four and five chips will be available from January 2017.



**Osram's surface mountable Oslon Black Flat S multichip LEDs are especially designed for ADB and matrix headlights**

This represents a significant expansion of the high-tech company's LED portfolio in this area of application. The powerful chips are based on state-of-the-art technologies. For the first time the light-emitting surface does not require a recess for contact with the bond wire and produces highly uniform light across its square format, making it easier to adapt the optics. The chips are individually controllable and offer very high contrast between neighboring chips which is 100% verifiable. These features enable oncoming traffic and traffic further ahead to be actively masked out with a high degree of contrast. Drivers benefit from the optimum distribution of light on the road at all times.

The Oslon Black Flat S series enables the benefits of adaptive matrix light to be offered not just on flagship models but also on cars in the entry-level and compact classes so drivers of these cars will also enjoy greater safety and comfort. In addition to glare-free high beam, other adaptive LED front lighting functions such as cornering light and city light can be implemented with the Oslon Black Flat S - without the need for any mechanical elements.

### ADB solutions for the entry-level segment

Up to now, only the Osram Ostar Headlamp Pro had individually controllable chips. The Oslon Black Flat S series now adds this feature to the portfolio. In addition, the chips are surface mountable and are compatible with standard processes. In contrast to the Oslon Black Flat, the Oslon Black Flat S LEDs have an optimized and symmetrical contact surface design which further improves heat removal and cycle stability. This combination of excellent thermal management and standard processing reduces system costs. The higher possible current load of up to 1.5 amperes provides sufficient light on the road from only three segments, and produces as much as 2,000 lumen from the 5-chip version. ■

## Luxtech Launches Industry-Leading Flexible LED Tape Family

Luxtech, a leading American manufacturer of LED modules, announced its FLEX family of architectural-grade flexible LED tape for luminaires. The new FLEX family addresses the concerns luminaire manufacturers have with previous LED tape products.

The product is cuttable in convenient lengths suitable to the North American market.

A heavier copper weight ensures brightness consistency and excellent thermal performance. Specification-grade 3M VHB adhesive ensures the product will remain bound to its housing for years to come.



**Luxtech's FLEX family addresses the concerns luminaire manufacturers have had with previous LED tapes**

FLEX also introduces a new supply chain paradigm for manufacturers used to sourcing rigid LED modules. Cuttable in increments as short as one inch, the product is compatible with a wide variety of luminaire designs. This FLEX-ability™ means inventories - and associated losses - can be drastically minimized.

Because of the reduced inventory requirements and non-rigid properties of FLEX, manufacturers have increased freedom to experiment with new luminaire designs. Before LED, manufacturers were limited to a few lamp types when designing fixtures. Luxtech pioneered custom LED modules, drastically expanding form factor possibilities. FLEX takes the LED advantage a step further, providing not only physical flexibility, but also creative flexibility.

Luxtech specifies 3-step MacAdam binning and LM-80 tested LEDs up to 90 CRI for all its products, including FLEX. This means luminaire manufacturers can expect the same high-quality color consistency and performance they get from their rigid Luxtech LED modules. In addition, FLEX is backed by a comprehensive 5-year warranty.

Over the coming weeks, Luxtech will formally announce each product in the new FLEX family. The flagship offering, FLEX CC, is cuttable every inch and works with familiar constant current drivers. FLEX Reach offers 99% brightness consistency over runs of up to 20 feet. FLEX Swerve bends in a planar direction up to 90°, and FLEX Color supports creative luminaire and signage design with individually-addressable RGB segments. ■

## BJB Releases Gen. 2 Zhaga Book 14 Standard Linear Flat System

BJB has released the 2<sup>nd</sup> generation Linear Flat System (LFS) with improved efficacy (up to 150 Lm/W) and light distributions. With these characteristics - which reflect the philosophy of "late stage finishing" - the LFS from BJB's OEM-Line represents an intelligent solution offering considerable added value to both luminaire manufacturers and end-users. These comprehensive benefits are proving effective: Zhaga created a new standard (Book 14) for Socketable Linear LED Light Engines based on BJB's Linear Flat System.



**BJB's second generation of Linear Flat System (LFS) modules are compliant to Zhaga Book 14**

### Product features & benefits:

- Improved efficacy: up to 150 lm/W
- 2 color temperatures: 3,000 & 4,000 K
- 3 different lengths: 2 foot, 4 foot, 5 foot
- Light output available up to 4900 lm
- 4 different light distributions for diverse applications (office, industrial, retail, ...)
- Improved visibility and contrast of the illuminated areas
- Consistent color quality and uniform light distribution
- Easy installation & maintenance
- Socket system allows for "late-stage finishing" and LED upgrading
- BJB Product Number: 32.130.0022 - 0027

The LFS consists of a socketable LED light source, lamp holder and lamp support. In this way, a luminaire can be manufactured via traditional means with the "lamp" integrated at a later stage. The appropriate LED light source in terms of luminous flux, color temperature and color rendering is only fitted to the customer's specification once the order has been placed - i.e. just prior to delivery or final installation of the lighting system. This enables the luminaire manufacturer to cut down on storage of expensive LED components which have the potential to rapidly become obsolete and to reduce high levels of capital commitment.

### "Late stage finishing":

The user always receives a luminaire with the latest lighting parameters - which makes sense when dealing with a fast-moving technology in which new LED generations come onto the market every year. There are also additional benefits during on-site installation as the LED light source can be clipped into the luminaire shortly before the lighting system goes into operation.

By keeping the luminaire body separate, it is also possible to replace the LED light source later, for example if retail stores have new lighting display requirements. A new, improved generation of LEDs can then be easily upgraded without replacing the entire fixture. The LFS provides the same flexibility as offered by conventional luminaires and the tool-free method of installation means convenient handling and ease of maintenance.

### Elegant design:

The impressive features of the LFS are its extremely compact design, its clean lines and its excellent lighting parameters. This innovative product is therefore predestined for use in luminaires or strip lighting systems which were previously the domain of T5 fluorescent lamps.

The light source, which is actually only 37 mm wide, consists of an extruded aluminum profile (available in different color styles) with an LED module and a diffusing PMMA cover. As it is fully enclosed, no special ESD measures are required by the luminaire manufacturer. This simplifies the production process significantly.

An alternative possibility for manufacturers with a high degree of vertical integration is to use their own LED light source with just the LFS lamp holder and lamp support. ■

## GlacialTech Introduces New Heat Pipe Heatsinks for High Bay Lighting

GlacialTech, the diversified lighting and thermal solution provider and innovator, is pleased to announce two efficient new heat pipe-equipped heatsinks suitable for high wattage LED bay light applications from 200 W to 350 W: the Igloo SR250HP-3 and the Igloo SR350HP-3.



GlacialTech's new Igloo SR250HP-3 and Igloo SR350HP-3 are ideal for high wattage bay light applications from 200 W to 350 W

### Features:

- Rated for 200-250 W and 300-350 W CoB or MCPCB LEDs
- Integral heat pipes for more effective heat dissipation and longer service life
- Low thermal resistance of 0.1663 K/W or 0.1125 K/W
- Suitable for indoor and outdoor applications
- Also available as a semi-knock-down (SKD) kit with box, bracket and lampshade
- Light-weight aluminum heatsinks are manufactured using a stamping process

These lightweight aluminum heatsinks are manufactured using a stamping process that allows them to achieve superb thermal performance of 0.1125 K/W thermal resistance for the Igloo SR350HP-3, and 0.1663 K/W for the Igloo SR250HP-3.

Their design, enhanced with integral heat pipes, achieves significantly better thermal efficiency than standard heatsinks.

GlacialTech's efficient and accurate stamping and bonding manufacturing process results in heatsinks that can provide high performance cooling at a very cost effective

price, by maximizing surface area while still maintaining a light weight and structural strength.

Thanks to their thermal and weight characteristics, these efficient heatsinks are ideal for bay light applications up to 200-250 W (SR250HP-3) or 300-350 W (SR350HP-3). Compared to less sophisticated products, these new heatsinks can cut energy costs by keeping temperatures low to enhance LED efficiency, reduce heat pollution, and, in the long term, prolong LED and driver life by safely removing harmful thermal energy that gradually damages components. In addition, the attractive, durable silver finish and anode surface treatment also help assure a long and trouble-free life for these products.

The heat pipe cooling incorporated in the Igloo SR250HP-3 and Igloo SR350HP-3 models helps to more efficiently cool the small surface area of CoB LEDs. The heat pipes situated in the base of the heatsink efficiently absorb the heat generated by the LED, and carry that heat up and away from the thermally-sensitive LED module,

Finally,  
Super High Power WICOP  
with 210 lm/W

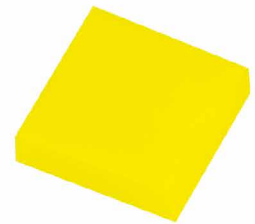

## WICOP Z8Y22

Super High Power  
Package-free LED  
Achieving 210 lumens per watt



and finally dissipate and radiate the unwanted thermal energy into the surrounding air.

Heat pipes are a totally self-contained cooling system that does not require any maintenance. For ease of use, the location of the heat pipes is marked on the base of the heatsink to help users avoid them while installing lenses or other accessories, in order to prevent damage or localized hot spots.

In addition, GlacialTech also offers a bay light knock down kit that incorporates these new heatsinks. This set of easy-to-assemble bay light components includes a power box for housing the LED driver, plus a bracket and lampshade. This semi-knock-down kit (SKD) allows lighting system integrators to easily assemble a custom lighting solution that makes best use of the LED modules and drivers of their choice. ■

## Diodes Introduces New Triac-Dimmable LED Controller/Driver Platform

The AL1692 LED controller/driver introduced by Diodes Incorporated is a platform-based design solution for triac-dimmable LED lamps. The internal MOSFET versions provide a low-cost solution with compact PCB size and directly drive lamps rated from 3 W to 13 W. The controller-only version with an external MOSFET can support higher power applications up to 25 W.



Diodes AL1692 controller-only version is offered in an SO-8 package while the MOSFET options are supplied in an SO-7 package

Intended for offline triac-dimmable LED lighting applications, the single-stage, buck-boost, non-isolated configuration of the AL1692 provides a high power factor, low total harmonic distortion and high triac dimmer compatibility solution to meet National Electrical Manufacturers Association (NEMA) Solid State Lighting (SSL) standards.

The AL1692 eliminates auxiliary winding and provides an accurate output LED current that ensures excellent line and load regulation, while its operation in boundary conduction mode (BCM) achieves high-conversion efficiency and eases EMI design to further reduce BOM cost.

The AL1692 offers four internal MOSFET options with various drain-source on-resistances for either 120 VAC or 230 VAC operation, and to cover a wide range of output voltage/current applications including: 4.7Ω/700 V, 4Ω/600 V, 3.2Ω/500 V and 2.8Ω/400 V. Enhanced internal protection features, such as LED open/short circuit protection, over-temperature, under-voltage lockout, leading-edge blanking, cycle-by-cycle over-current protection, and thermal fold-back protection improve system safety and reliability.

The controller-only version of the AL1692 is offered in an SO-8 package while the MOSFET options are supplied in an SO-7 package. ■

## Diodes Announces Constant Current DC-DC LED Driver

Diodes Incorporated has introduced the AL8860 hysteresis mode DC-DC step-down converter, which is designed for driving single or multiple series connected LEDs efficiently from a voltage source higher than the LED voltage. With its integrated MOSFET, this product provides a low BOM cost solution for low-voltage industrial and automotive LED lighting applications, including illuminated signs and backlighting, as well as an LED retrofit for replacing low-voltage halogen lamps.



Diodes new AL8860 constant current DC-DC LED driver with low standby power mode provides up to 40 W output power

Operating from an input supply between 4.5 V and 40 V, the AL8860 can directly source a 1 A output current in the TSOT25 package, or up to 1.5 A in the more thermally efficient MSOP8-EP package. Contingent on the supply voltage and other external components, the AL8860 is capable of providing up to 40 watts of output power.

In addition to the internal 40 V 0.2 Ω NDMOS power switch, the device integrates a high side output current sensing circuit that allows the use of a single external resistor to set the nominal average output current. Deep dimming can be applied via a CTRL pin using either a DC voltage or a PWM signal. The same pin also implements soft-start operation, with the time adjusted by an external capacitor. Applying a voltage of 0.2 V or less to this pin will turn off the output and cause the device to enter a power-saving standby state.

The AL8860 includes protection against LED short and open circuits, and over-temperature to ensure reliable system operation. ■

## ams Launches AS7221 Spectral Tuning IoT Smart Lighting Manager

ams AG, a leading provider of high performance sensors and analog ICs, has announced the AS7221, the industry's first integrated white-tunable smart lighting manager. Lighting manufacturers designing with the AS7221 can now quickly integrate high-precision CCT, or "Kelvin-tuning", capabilities into their Internet of Things (IoT) smart lighting offerings. The versatile architecture, which includes an I2C extension interface, positions the AS7221 to deliver Internet of Awareness™ IoT sensor hub platform capabilities for sensing functions such as air quality, temperature, occupancy, and presence.

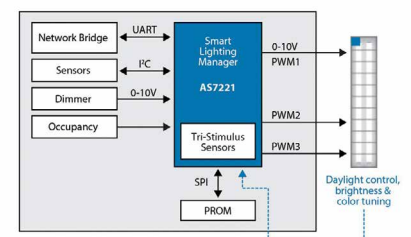

ams' extension to smart lighting manager family enables cost-effective, accurate, IoT-connected variable-CCT LED lighting

**Key features of the AS7221 include:**

- Tri-stimulus XYZ color sensor for direct mapping into the CIE color space
- Serial UART for simple connection to standard networks and wireless clients
- Fully network-enabled architecture with high-level, driverless command set for a wide array of advanced integrated luminaire controls
- I<sup>2</sup>C expansion capability to enable IoT sensor-hub platform functionality

The AS7221 is equipped with an industry-first embedded tristimulus CIE XYZ color sensor to enable precise color sensing with direct mapping to the CIE 1931 color space. This smart lighting manager is a fully integrated luminaire control system, compatible with standard 0-10 V inputs and enabled for IoT connectivity and network control through standard clients such as Bluetooth Smart, ZigBee or WiFi, through a complete Smart Lighting Command Set. LED control for spectral tuning is implemented via direct PWM channel outputs, resulting in a high-precision solution that slashes development and integration

time when compared with more bulky discrete component approaches.

“With LEDs having enabled the ‘digital lighting revolution’, the next logical step is control integration directly into the luminaires,” commented Philip Smallwood, Director of LED & Lighting Research for the respected photonics market research firm, Strategies Unlimited. “Two potential keys to that move, which make it both practical and cost-effective, are sensor fusion and core integration at the semiconductor device level. The result will take us right down the path of realizing the LED lighting industry’s long-standing vision of truly controllable, connected and human-centered smart lighting that will deliver well-being, productivity and efficiency benefits across the board.”

The AS7221 is the first extension to ams’ recently announced Cognitive Lighting™ smart lighting manager family. The compact AS7221 will be available in a 5x5 mm LGA package, for flexible integration into both luminaires and larger replacement lamps.

The device provides precise color point tuning, smoothly controlling CCT transitions between configured warm and cool white LED strings within a luminaire. In addition to the color- and CCT-tuning functions, the AS7221 includes automatic configuration support for ams’ TSL4531 ambient light sensor for turnkey daylighting capabilities.

“The next generation of lighting will be defined by three key characteristics: controllability, adaptation and connected architectures,” said Tom Griffiths, Senior Marketing Manager at ams. “Our new family of smart lighting managers meet those criteria. With this latest entry, we are addressing the luminaire manufacturers’ critical time-to-market challenge for developing and deploying a spectrally tunable luminaire that is cost-effective, accurate, and which smoothly integrates into the Internet of Things”.

Pricing for the AS7221 Spectral Tuning IoT Smart Lighting Manager is set at \$3.13 in quantities of 10,000 pieces, and is available in production volumes now. ■

# HONGLITRONIC

## We are Leading the White Light LEDs in China



LED Filament



SMD2835(210lm/W)



COB LED(155lm/W)



AC COB(CE)



UV



**HONGLIZHIHUI**  
鸿利智汇  
Stock Code: 300219



Official website

Hongli Zhihui Group Co.,Ltd.

T +86-20-8673 3333 ext 3033

F +86-20-8673 3883

sales@honglitrionic.com

en.honglitrionic.com

## Inventronics Expands EBS Product Line

Inventronics has announced the release of the new EBS BTE Series of 40 W, constant-current programmable IP20 LED drivers. They operate from 176-305 Vac input and are designed for operation in both Class I and Class II environments. They are primarily aimed at street lighting applications but are equally capable in any luminaire where robust performance is needed. The advanced common mode surge protection fully meets EN61000-4-5 and EN61547, even in Class II luminaires, thus providing market leading protection against common mode surge; the most frequent cause of failure in street lighting.



**Inventronics' new EBS series is a Zhaga compatible, rugged and feature-rich DALI LED driver series**

The EBS BTE family can also be upgraded using an optional endcap accessory allowing it be used as an "independent" LED driver. The plastic housing is IP20 rated which allows for even more cost reductions when you need a full-featured LED driver but not the costs associated with an IP67 rating. The Zhaga compatible rectangular design makes it the perfect choice for the more compact and slimmer European street luminaires where the standard driver form may be too large to accommodate.

The EBS Series utilizes convenient push terminals instead of cabling that provides flexibility and easier installation while reducing production and installation costs. Offering flexibility with 2 constant-power, programmable models delivering up to 40 W at output currents from 450 mA to 1050 mA. Each highly efficient model provides a 12 V / 200 mA auxiliary output capable of powering sensors or wireless controllers, they provide numerous intelligent programming options including output lumen compensation (OLC), DALI, AC dimming, intelligent timing and dim-to-off with low standby power consumption for greater energy savings.

The rugged thermal design of these drivers enable them to run cooler, significantly improving reliability and extending product life. The lifetime of these drivers is calculated to be at least 93,000 hours when operating at 80% load. These drivers also include all-around protection features which consist of: over-voltage, over-temperature for both driver and external LED array, and short-circuit protection as well as thermal sensing and protection for the LED module.

You can increase your ease of installation and reduce production times even further by combining the EBS Series with the Inventronics PRG-MUL2 programming tool. This combination furnishes fast, off-line mass programming capabilities that allows auto programming at the push of a button through user friendly PC based software.

This new family is approved to ENEC, TUV, CE, CB, CCC, KS, DALI and Double Insulation standards. ■

## uPowerTek Launches NFC Programmable 75 W LED Driver

To make smart lighting simple and reliable, uPowerTek recently released a new 75 W NFC programmable LED driver. The output current of the driver can be programmed by a NFC programmer, touch free and fast. Compared with other programmable LED drivers, uPowerTek's NFC programmable driver has several advantages.



**uPowerTek's NFC programmable LED drivers are available with power ratings from 30-400 W**

**Advantages:**

- Touch Free Programmable
- Passive Programmable
- Fast and Safety
- Easy to operate
- IP67 waterproof
- Compact Size
- UL Class P passed

**Technical Features:**

- Supply Voltage: 90-305 Vac or 127-420 Vdc
- Great Surge Immunity 10 kV
- 100,000 Hour Life @  $T_c=75^\circ\text{C}$
- 5 Year Warranty @  $T_c\leq 80^\circ\text{C}$
- Airset™ NFC Programmability
- 0-10V/PWM/Time/DALI (Optional) Dimmable
- 0.5 W Standby Power
- 12 V 300 mA Auxiliary Power to Power Controllers and Fans (Optional)
- Input Over Voltage Protection (Optional)
- Class II Model Available
- UL Class P, Class 2
- ENEC/CB/CCC SELV Output
- Safety according to EN 61347-1, 61347-2-3, 61347-2-13, 62384

For programming the driver, users don't need to connect wires. Connecting the programmer to the computer and get close enough to the driver is all that needs to be done. Then it's finished in less than 1 second. This is the fastest programming time in the industry.

Besides the NFC programming function, there are also some additional features to mention. 3 models of the 75 W series are available to cover most of the popular output currents. Each of these models has a wide output current range. ■

## LG Innotek Programmable LED Drivers - Convenient and Cost Reducing

LG Innotek announced that it will release a programmable LED driver for wireless lighting control in the American market. The product has a moderate price, but shows outstanding performance. It is expected to gain popularity as a wireless lighting control solution in the market.



**LG Innotek's Programmable "Helios" 30 W LED Driver (top) and 55 W LED Driver with ZigBee module (bottom)**



The company revealed that it has supplied its programmable power supply for wireless lighting control, "Helios", to a renowned LED lighting company located in the North America. The programmable LED driver includes two models: a 30 W and a 55 W. Helios allows you to adjust output freely so it is possible to implement LED lighting for any environment. Also it has a built-in wireless network module inside the product. It supports wireless control based on ZigBee, which is an inexpensive communication method with low power consumption. And you only need to replace the module mounted on the power supply to support wireless control based on the Bluetooth low energy (BLE) method.

The company shortened the development period to two months based on the core technologies related to wireless communications and reduced the price of the product by 20% compared to its competitors'.

LG Innotek also released wireless interface module (WIM) together with the Helios. You can mount the WIM on the output terminal to support wireless control and use it as a wireless lighting control solution at a cheap price without replacing the existing lighting devices.

The company said that it secured the high reliability of the product by utilizing its three main world best technologies in the field of wireless communication, power circuit design, and LED light source.

If a LED driver for LED lighting is unstable, it may supply too much power to the lightings, lowering their lifespan and energy efficiency. The company's product supports normal operation for up to 50,000 hours with the energy efficiency of up to 89%.

In 2013, the company developed a wireless LED lighting control system that supports four main wireless communication methods including Wi-fi, Bluetooth, ZigBee, and Z-Wave for the first time in the world, boasting its technical superiority. LG Innotek plans to release LED driver for wireless lighting control that support other communication methods in addition to ZigBee and BLE in the American market to solidify its foothold in the market. ■

## RECOM Introduces Super-Flat 11 & 13 mm High LED Drivers

RECOM has released an entire family of super-flat constant-current and constant-voltage LED drivers suitable for stand-alone LED luminaires where space - especially height - is at a minimum.



RECOM's super-flat 11 and 13 mm high LED Drivers are ideal for furniture, cove, and cabinet lighting

At only 11 and 13 mm high, these LED drivers can be used in concealed installation applications such as in furniture, unobtrusive mounting in shelving units, behind glass panels or mirrors, etc. They are equally suitable for accent lighting along corridors, on floors and ceilings, or for installation in lighting strips and compact designer lamps.

The drivers come in 350, 500 and 700 mA constant-current outputs (RACD06-LP, RACD12-LP, RACD20-LP) or 12 V and 24 V constant-voltage outputs (RACV06-LP, RACV12-LP, RACV20-LP). The LED drivers are suitable for ambient temperatures between -20° and +50°C and offer an isolation voltage of 3.75 kVAC/1 minute. The reduction in height also comes at a reduced price, but the performance quality is not compensated - the LED drivers are short-circuit and overload protected, CE, CB, and ENEC certified, have an excellent standby power to meet tough new power-consumption regulations, and come with a full 3-year warranty. ■

## TRP Introduces New 100 W LED Power Supply

Thomas Research Products has introduced a new 100W power supply for LEDs. This new model provides high

# Explore the full spectrum!



## High-precision LED / SSL measurement solutions

- ▲ Leading test equipment for standard & high-power LEDs & OLEDs
- ▲ Proven solutions for production, R&D and quality control applications
- ▲ Complies with all International and European standards like CIE S025 or EN 13032-4
- ▲ Engineered and made in Germany

## Opt for our expertise!

LGS 1000  
Goniophotometer  
with new features



**We bring quality to light.**

performance at a lower cost. Thomas Research Products manufactures complete LED power and control solutions for OEMs and retrofiters.



**TRP's new 100 W LED driver is designed for harsh environments and hazardous locations**

The LED100WP1-24 constant voltage driver is designed as a power supply for a wider variety of applications. It provides 24 V Class 2 output and features smooth performance from full load to very low load. The metal F-Can enclosure design makes it easy for OEMs to handle. This model is also UL Type HL rated for use in hazardous locations.

The new driver can be used in indoor or enclosed outdoor commercial, institutional and industrial applications. It features an IP20 rated case. The UL SAM Manual listing and white finish make the LED100WPS-24 perfectly suited for the LED sign industry.

TRP's new driver features the same high performance for which the company's other drivers are known. It comes with the company's standard 5 year warranty. All high-performance LED Drivers from TRP offer high quality, long life, high efficiency and are cost-competitive. ■

## Industry's Lowest Profile LED Module Connectors from Hirose

Hirose, a leader in the design and manufacture of innovative connector solutions, has launched an easy to use, tool-less strip & poke connector ideal for LED lighting module applications. With a height of only 4.2 mm, the KN27 Series combines a space saving design of 3.9 mm width (for single contact) and 11.85 mm length - all using a standard industry footprint. In addition, the smaller KN27 Series offers a higher current rating of up to 9 A.

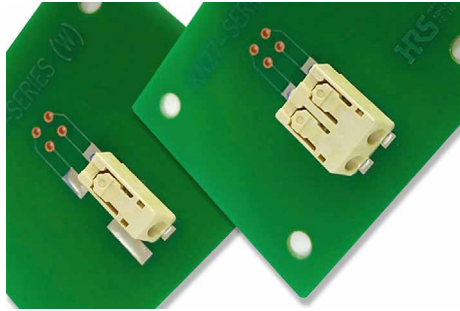

**Hirose's space saving KN27 Series LED lighting module connector features a strip & poke design that is well suited for replacing traditional terminal blocks**

The KN27 Series connector was developed to replace traditional terminal blocks in LED lighting module applications. The strip & poke design eliminates the need to screw down the connection and check for loosened terminal block screws, which offers a more reliable termination that reduces installation variation, time, and cost.

The KN27 Series LED lighting connector features a rugged 2-point contact design that provides a reliable connection. The connector has an internal guide system that makes cable insertion simple and foolproof. A lever provides for easy cable extraction.

"Hirose has raised the bar by lowering the height of LED lighting module connectors," said Rick van Weezel, Vice President of Sales & Marketing at Hirose Electric USA. "The KN27 Series combines one of the industry's lowest profile connectors with a 2-point contact system for maximum reliability in a miniature package."

The KN27 Series is offered in 1-pin or 2-pin models, and accepts 18 to 24 AWG. The connector meets halogen-free requirements and is RoHS compliant. ■

## New Lumawise LED Holder Type Z35 from TE Connectivity

TE Connectivity (TE), a world leader in connectivity and sensors, has introduced the Lumawise LED holder type Z35 to provide a higher level of integration via a solderless connection to chip-on-board (COB) LEDs, using standard pan-head and countersunk screws. It is suitable for LED boards from numerous manufacturers, in two sizes: 13.5x13.5 mm and 12x15 mm.



**TE's new LED holder enables quick and easy assembly with solderless connections**

TE's new Lumawise holder enables quick and easy assembly through tape-in LED retention and integrated poke-in wire termination. The holder also provides easy attachment of secondary optics. The high-reflectivity, halogen-free, flame retardant thermoplastic housing material also helps protect the LED chip against halogen outgassing.

Typical applications for the Lumawise LED holder type Z35 include spotlights, track lights, recessed downlights, wall sconces, architectural and street lighting, sign and symbol luminaires, and runway lights. ■

## Cree Adds 3000 K CCT Version to their IG Series Luminaires

Cree, Inc. extends its industry-leading IG Series LED parking structure luminaires to include a warmer color temperature and standard 0-10V dimming for better light experiences with enhanced aesthetics and performance. The result is more choices that meet customer preference for warm, inviting light. Featuring Cree WaveMax™ Technology, the IG Series delivers low-glare comfort and defeats shadows for enhanced safety and visibility while delivering exceptional energy efficiency and fast payback.



**Cree's groundbreaking IG parking luminaire series is also available in warm white**

“Parking structure operators are under constant pressure to lower operating costs while providing safe and visually appealing lighting,” said David Elien, Cree senior vice president and GM, commercial lighting. “With these new standard features, the high-performance IG™ LED parking structure luminaires not only outperform existing LED and metal halide solutions, but also offer a lower total cost of ownership while making a great first impression.”

The series offers enhanced performance and flexibility to meet code requirements with new, standard 0-10V dimming for Cree IG parking structure luminaires that do not include a factory installed sensor, enabling easy integration with advanced control systems to maximize energy savings. The increased functionality allows parking structure owners to seamlessly integrate wireless or wired control systems for daylight harvesting, remote monitoring and occupancy sensor capabilities further reducing energy usage for an even lower total cost of ownership.

Available in 3000 K, 4000 K and 5700 K color temperatures, the highly efficient parking garage luminaires can deliver more than 80 percent energy savings and quick payback of less than two years compared to outdated metal halide lighting. Programmable motion controls further increase these savings and enable a simple way to customize settings for high or low occupancy applications.

The IG Series is backed by Cree's industry-leading 10-year warranty and available through Cree lighting sales channels throughout the U.S. and Canada. ■

## Verbatim's AR111 LED Lamps for Anti-Glare Halogen Replacements

Verbatim announces its next generation of anti-glare AR111 retrofit LED bulbs, which serve as true performance upgrades for replacing halogen lamps, and to demonstrate a new range of linear LED products.



**Verbatim's next gen. AR111 LED lamp's design helps avoid the uncomfortable glare that often characterizes LED lamps**

To avoid the uncomfortable glare that often characterizes rival LED products, Verbatim's dimmable 10 W AR111s feature a unique design that perfectly mimics the lighting effect of a traditional halogen lamp by emitting light indirectly via the reflector.

Ideal for general lighting areas such as the reception area of a hotel, a restaurant or a shop along with other areas where bright yet comfortable light is required for long periods, Verbatim's AR111 LED light bulbs save up to 89% energy compared to equivalent halogen lamps. They are also lighter, brighter and

**All Together Now** Introducing the new Fulham Europe

**FULHAM**  
WORKHORSELED

### The Power of Programming

The WorkHorse LED family of constant current drivers features programmable output current, dimming curve, thermal feedback, and more. With DALI and 0-10V models available, the drivers can match the output of existing luminaires or serve as a flexible platform for new designs.



**FULHAM**  
LUMO SERIES  
Formerly Lumotech

### Introducing the Lumo Series

Fulham Europe is proud to announce the Lumo Series of reliable, efficient LED drivers. Formerly Lumotech, these innovative drivers are designed and manufactured with exceptional standards for performance and reliability.



Contact us today to learn more about Fulham's innovative LED solutions  
sales.eu@fulham.com | +31 72 572 3000 | [www.fulham.com](http://www.fulham.com)

**FULHAM**  
Lighting... Global. Intelligent. Sustainable.

provide higher efficacy and longer lifetime than competing LED products enabling customers to reduce operating and maintenance costs.

The new generation of dimmable AR111s deliver a luminous flux of up to 750 lm and luminous intensity of up to 5700cd. With a lumen efficacy of up to 75 lm/W (up to 25% more than competitors), they are lightweight at just 90g (twice as light as most rival products) and last longer at 40,000 hours, all without requiring a separate large heatsink since, thanks to technology from Mitsubishi Chemical Corporation, they can employ the reflector as a heatsink. Available in 2700, 3000 and 4000 K colour temperatures and beam angles of 12, 25, and 40 degrees, the products are ideal for a wide range of residential, retail, office and hospitality requirements.

The Verbatim LED AR111 range features an EEI (Energy Efficiency Index) of 0.20 or less to ensure it matches new EU eco-design requirements for energy related products, which came into force in September 2016. Besides the peace of mind presented by a 5-year warranty, customers also benefit from easy installation given the product's perfect size and shape compatibility with AR111 fixtures on the market. ■

## Lextar's ALLUXIA Leads the Way in Human-Centric Lighting

Lextar Electronics is setting the trend with human-centric lighting, a combination of LED lighting fixtures with a control system that can simulate day and night to change the color temperature of the light. At the same time, the company also launched "Solar White", its latest LED light quality upgrade technology capable of generating an LED light source similar to natural sunlight.



**Lextar's ALLUXIA not only provides HCL, but is also characterized by high Rf and Rg values for improved color rendering**

Human-centric lighting currently is a focal issue of the Lighting Industry Association (LIA) in Europe. Lextar's human-centric lighting system comes with a control that can adjust the color temperature of the LED to simulate morning to evening light and create a natural light environment in line with people's physiological rhythm, suitable for use in indoor environments that lack natural lighting. In addition, human-centric lighting can also be used to influence people's mood and spirit, with warm colors promoting relaxation while cool colors help with contraction and enhance productivity. Lextar will integrate human-centric lighting in its frameless flat panel light series ALLUXIA. ALLUXIA also has won the German Design Award and the Red Dot design award 2016.

In order to enhance the quality of LED light and to show the true colors under the light, Lextar launches its in-house developed "Solar White" LED technology, whose LED wavelength distribution can simulate real sunlight, with an Rf (color fidelity index) of up to 94 and an Rg (color gamut score) of 99\*. Lextar's Solar White LED technology generates a light source most closely resembling natural sunlight. It makes indoor, lit environments more comfortable and healthy, and it can truthfully bring out hues and red and blue color saturation.

Lextar CEO Advisor Allen Huang said, "Today's LED market pursues product functionality and cost control, however

what's often overlooked is the importance of light to human physical and mental health. We believe that pursuing the creation of high-quality lit environments to enhance the added value of LED lighting is an important direction. Lextar is currently actively developing such products with brand customers in Europe." Huang added that statistics indicate that people spend about 90% of their time indoors, and thus rely heavily on artificial lighting. Therefore, the theme of Lextar's booth at the Hong Kong lighting exhibition focuses on improving the quality of indoor lighting. The booth will showcase a wide variety of soft light sources and flat panel light with simple but stylish design. The booth also displays light color temperature tunable fixtures as well as the Solar White LED technology, leading the international trend into a new era of LED lighting.

\* In May 2015, the Illuminating Engineering Society of North America (IES) published IES TM-30-15, its new method for evaluating light source color rendition, which made up for the shortcomings of its predecessor Color Rendering Index (CRI). The CRI index cannot fully express the human-eye perception of color. IES TM-30-15 presents the "color fidelity index" Rf and the "color gamut index" Rg as new powerful tools for improving color rendering.

The fidelity index (Rf) is used to indicate the similarity of the standard colors to the reference light source when the test light source is illuminated. The index runs from 0 to 100. The higher the value, the better the color fidelity. The gamut score (Rg) represents the change in saturation of the standard colors compared to the reference source under the test light, and an index value of 100 represents the best possible saturation. The release of the IES TM-30-15 standard is expected to contribute to improved lighting and improved quality of life in lit environments. ■

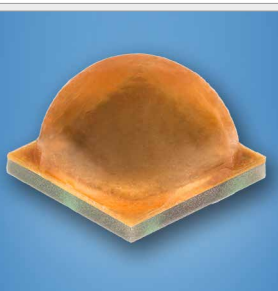

### Cree's New XLamp® XHP50.2 LED Delivers the Highest Lumen Density in Its Class

Cree's XLamp XHP50.2 LED delivers up to 7% more lumens and 10% higher LPW than the first gen XHP50 LED. The XHP50.2 can produce more than 2,500 lumens from its 6 mm light emitting surface to reduce size, cost and enable innovative solutions for applications from spot to street lighting. LM-80 data is available to reduce the time for ENERGY STAR® and DesignLights Consortium® qualifications.

[www.cree.com/xlamp/xhp50\\_2](http://www.cree.com/xlamp/xhp50_2)

**CREE** 

## LECs - The Light of the Future Thanks to Nanostructures

In the future they are to light up the insides of handbags or make evening joggers stand out in the dark: Light-emitting electrochemical cells, LECs, offer many advantages compared to familiar LEDs, but there's still something lacking - the right light. Until now only yellow light LECs are suitable for realistic use. But at least one other light color is needed for more neutral light. Researchers in the Center for Nanointegration (CENIDE) of the University of Duisburg-Essen (UDE) have now been able to selectively change the color for the first time and at the same time increase the performance of the LECs.

Their "older brothers", the LEDs, are now generally well-known and their use is widespread. They are extremely bright and efficient, but their production in a high vacuum is expensive, they are not flexible and the area lit by them is very sharply limited. By contrast, initial LEC prototypes already exist which, under normal room conditions, can be pressed directly onto a

substrate. They are also flexible and have a broad light spectrum, which is enticing designers in all industries: The talk is of clothing that glows in the dark, shimmering wallpapers and head-up technology, which displays the right route in the windscreen of a vehicle. So much for the theory.

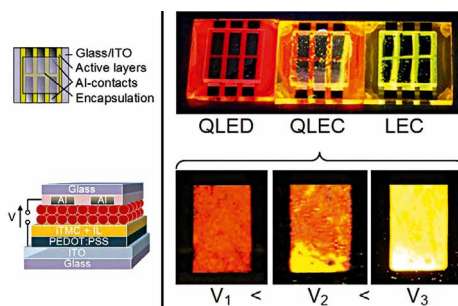

Left: The basic structure of LECs. Right: Comparison of an LED with quantum dots, Frohleiks' new development (QLEC) and an LEC without quantum dots under UV light (top, l to r). The QLEC's light colour with increasing voltage (bottom, l to r)

Julia Frohleiks, Ph.D. student in the junior research group of Dr. Ekaterina Nannen, has now made the theory come a step closer in practice too: Her idea is based on semiconductor quantum dots, tiny structures

in which completely independent physical laws prevail. Onto the classic layer of organometallic molecules, Frohleiks placed a further layer made of only 5 nanometer large quantum dots, which stem from the Bilkent University in Ankara (Turkey).

With a low voltage, the roughly 1.5 x 1.5 cm LEC actually lit up red. Yet the quantum dots have another additional effect: The hybrid element lights up immediately as soon as the voltage is applied and reaches its maximum intensity after five minutes. A reference LEC without quantum dots on the other hand, with the same voltage, needed five minutes before it lit up weakly for the first time, and took an hour to reach its maximum.

However, the light color of the prototype changes back to yellow when the voltage is increased. "This is definitely an effect on which we still have to work", says Frohleiks. The next challenge on her list is white LECs, which she wants to achieve with blue quantum dots.

Original Publication: DOI: <http://pubs.acs.org/doi/abs/10.1021/acsami.6b06833> ■



# 2835



0.2w

0.5w

1w

## Global Patent



SHENZHEN REFOND OPTOELECTRONICS CO.,LTD.

Add: Building #1, 10th Industrial Zone, Tian Liao Community, Gong Ming Area,  
Guang Ming New District, SHENZHEN, CHINA  
TEL: +86-755-66839118 FAX: +86-755-66839300 E-mail: konny@refond.com

Stock Code : 300241.SZ  
[www.refond.com](http://www.refond.com)



## TECHNICAL REGULATORY COMPLIANCE UPDATE



Segment	Product	Standard (Certification)	Region	Technical Regulatory Compliance Information
Lighting	Luminaires - Part 1: General requirements and tests	EN 60598-1:2015	Europe	<p>This standard will come in force on October 20, 2017. It specifies general requirements for luminaires, incorporating electric light sources for operation from supply voltages up to 1 000 V. The requirements and related tests of this standard cover: classification, marking, mechanical construction, electrical construction and photobiological safety. This edition constitutes a technical revision and includes the following significant technical changes with respect to the previous edition:</p> <p>Major revision of the part 1</p> <ol style="list-style-type: none"> <li>Annex R indicates the major changes requiring retest of already qualified luminaires acc. to old version</li> <li>Photobiological hazards requirements added</li> <li>More precise requirements for insulation between different types of electrical circuit</li> <li>Requirements to support the construction methods for new LED luminaires entering the market</li> <li>Other updates and improvements</li> </ol> <p>To state a few:</p> <ol style="list-style-type: none"> <li>Clause 4.28: Fixing of thermal sensing controls: Any temperature sensing control external to lamp control gear shall not be of the plug-in or an otherwise easily replaceable type. It shall be reliably kept in its specified position with regard to the control gear. Adhesive fixing of temperature sensing controls shall not be used where UV radiation emitted from a lamp could degrade the reliability of the fixing during the life of the luminaire. Temperature sensing controls shall not be mounted outside of the luminaire enclosure.</li> <li>Subclause 12.5.2, Thermal test (abnormal condition) ignitors marked tc + x: Thermal test of luminaire with ignitor marked with tc + x need to be reevaluated and tested due to requirement of a note under table 12.5 was transferred to a mandatory requirement.</li> <li>Subclauses 4.32, Clause 10.2: Over voltage protective devices: Over voltage protective devices which are external to control gear and connected to earth, shall be used only in fixed luminaires and connected only to a protective earth and shall comply with IEC 61643-11</li> </ol>
Lighting	Luminaires - Part 2-20: Lighting chains	EN 60598-2-20:2015	Europe	<p>This standard will come in force on December 30, 2017. It specifies requirements for lighting chains fitted with series, parallel or a combination of series/parallel connected light sources for use either indoors or outdoors on supply voltages not exceeding 250 V, here the requirements for rope lights (sealed lighting chains) have been removed and are now dealt with in EN 60598-2-21 and Interconnecting connectors requirements are added.</p> <p>Lighting chains for outdoor use shall have a IP44 or higher rating.</p> <p>Additional test voltage requirements for class III lighting chains and requirements for fault condition test of LED lighting chains.</p>
Lighting	Luminaires - Part 2-22: Luminaires for emergency lighting	EN 60598-2-22: 2014	Europe	<p>This standard will come in force on July 24, 2017. It specifies requirements for emergency luminaires for use with electrical lamps on emergency power supplies not exceeding 1 000 V. An update of the definition of emergency lighting and emergency escape lighting is done and below were Introduced-</p> <ul style="list-style-type: none"> <li>Practical emergency lamp flux - PELF</li> <li>Self-contained emergency luminaire</li> <li>Emergency ballast lumen factor</li> <li>Emergency luminaire mounted on lighting track system</li> <li>Emergency remote box</li> </ul> <p>This standard also clarifies additional marking and photometric data requirements for emergency luminaires on lighting track systems and also improved requirements for indicators, additional requirements for emergency luminaires and adjustable emergency luminaires, mounted on lighting track systems. Annex A deals with Batteries for self-contained emergency luminaires which includes sealed nickel cadmium, valve regulated lead acid and nickel metal hydride batteries. Other battery types may be allowed provided they conform to their relevant safety and performance standard and the relevant requirements of this standard.</p>

**Disclaimer:** This information is research work of TÜV SÜD Product Service and is intended for general information purposes only. The content is publishable only after having the consent of TÜV SÜD Product Service. If it is published with any changes, the company is not liable for it. The information is subject to change and all rights for it are reserved by TÜV SÜD Product Service GmbH.

A free training can be arranged for a clear understanding of the upper stated standards.

For further information on the latest upgrades and testing standards and training, please contact [cps@tuv-sud.com](mailto:cps@tuv-sud.com)



# TAIWAN INT'L LIGHTING SHOW

SMART DESIGN  
RADIANT LIFE



# 2017 APR. 12-15

Taipei Nangang Exhibition Center, Hall 1

### FEATURING:

- Lighting Integration **New**
- Home/Residential Lighting
- Commercial Lighting
- Intelligent Lighting
- Outdoor Lighting
- Lighting for Kitchen & Furniture
- Plant Factory & Lighting
- Automotive Lighting
- Lighting Design **New**
- Special Lighting
- Health Care and Institutional Lighting
- Medical, Cosmetic and Beauty Lighting
- Building Material & Lighting Applications
- Lighting Accessories
- Lighting Production Equipment
- Test & Inspection Equipment



[www.TILS.com.tw](http://www.TILS.com.tw)

Organized by



Implemented by



Supported by



# CIE Looking Forward - Top Research Strategy Topics

In 2013 CIE celebrated its centenary; one hundred years of contributing to the development and compilation of scientific and technical knowledge on light and lighting. During the past hundred years light has become more than just a way to illuminate the spaces around us with our knowledge of the way light interacts with matter being used in many aspects of our daily lives. In keeping with this, the CIE works in all areas covering vision, color, and measurement of light, interior and exterior lighting, photobiology and digital imaging - perhaps something not widely known amongst the lighting and LED professional communities.

It's clear that light and the interaction of light with matter will continue to be part of new technologies over the next hundred years. Current and new technologies require well-founded knowledge, both fundamental and applied, to ensure that they can be used with confidence in regards to their safety and quality. CIE publications provide that confidence. They are based on the strongest available scientific evidence and follow a rigorous review and ballot process. To develop consensus-based documents fit for the future scientists are required to engage now in building the knowledge base that will support them in the future.

Looking forward the CIE has developed a research strategy detailing the top ten topics needing input from researchers and awareness from stakeholders. The summarized research topics presented here are those considered by the CIE as needing immediate attention from the research community in support of developments in lighting technology and application. Publications in the peer-reviewed literature on these topics will provide the basis for the next generation of CIE technical reports and standards. ■

## RECOMMENDATIONS FOR HEALTHFUL LIGHTING AND NON-VISUAL EFFECTS OF LIGHT

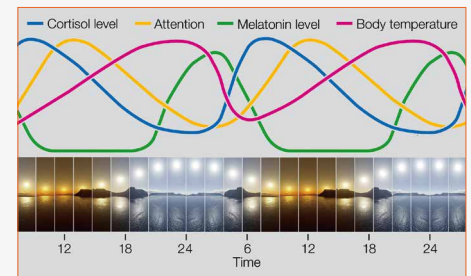

Although light is defined as electromagnetic radiation that provides the stimulus for vision, we now know conclusively that photo detection also has many other essential physiological and psychological effects on humans and other organisms. Fundamental photobiology research adds to this knowledge base daily. However, targeted research, performed in concert with applied lighting scientists, will be required to put this knowledge to use as part of integrated lighting recommendations and designs.

In May 2016, CIE published a detailed research agenda for this topic (CIE 218:2016).

### Selected examples are:

- What pattern of daily light and dark exposure (intensity, spectrum, timing, duration) best supports well-being, both for circadian regulation and acute effects during waking hours (e.g. alertness, emotion, social behavior)? How does this vary throughout life, from infancy to old age?
- In addition to circadian regulation, what physiological and psychological processes are influenced by ocular light detection?
- There are known medical uses of light to treat certain skin disorders and hyperbilirubinemia. There is speculation that inadequate light exposure during childhood contributes to the development of myopia. These ideas lead to the general question: Are there behavioral or physiological effects of extra-ocular absorption of optical radiation that should influence lighting recommendations?



## COLOR QUALITY OF LIGHT SOURCES RELATED TO PERCEPTION AND PREFERENCE



With the development of new lighting technologies, LED light sources are increasingly used for general lighting. These light sources are creating diversity in light spectra and imposing new challenges in assessing their color quality. While a new color fidelity index is being developed in CIE (TC 1-90) toward a future update of the CIE Color Rendering Index (CRI), a color fidelity index alone will not be sufficient to assess the overall color quality of light sources. Scores of a color fidelity index do not always agree with perceived color rendering experienced by end users.

### Key research questions:

- How can “preference” (or a model for color quality perception) be clearly defined and assessed for the intended end use? It may also be affected by users’ long term visual experience. How can it be addressed?
- Are the individual variations in such preferences too large to define general preference?
- Can the preference for Chroma saturation and white light chromaticity be substantially different in different regions (or races of people) in the world?
- What are the relevant parameters to measure the subjective aspects of color quality and the whiteness index?
- How do we design an index to measure the whiteness perception of a light source? How do we apply the surface whiteness indices for lighting applications?

## INTEGRATED GLARE METRIC FOR VARIOUS LIGHTING APPLICATIONS



The brightness of light sources, be they electric luminaires or windows, may have a negative effect on the performance of visual tasks (disability glare) but it may also cause a feeling of discomfort without having a directly measurable effect on visibility: discomfort glare. This psychological effect has been extensively studied since the 1940s, when the increase in general illumination levels started to lead to complaints about discomfort from excess light. In general, discomfort is known to increase with increasing luminance of the light source, increasing light source size (at a fixed luminance), decreasing background luminance, and decreasing distance of the bright object from the line of sight. However, discomfort tends to be lower when the light source is daylight rather than when it is electric light. The exact relationship of these quantities has been modelled by various formulae that predict discomfort based on stimulus parameters.

### Key research points:

- What physiological or psychological mechanism is responsible for discomfort arising from excessive luminance?
- Develop a model of the discomfort arising from excessive luminance, preferably based on parameters that can be related to the discomfort mechanism, which covers multiple application areas.
- Establish a glare metric method that allows the results to be generalized and applied to other application conditions and other lighting technologies.

## CALIBRATION SOURCES AND ILLUMINANTS FOR PHOTOMETRY, COLORIMETRY, AND RADIOMETRY



In photometry and radiometry appropriate calibration sources and transfer detectors are necessary to ensure traceability of measurements. In addition, calibration conditions should be chosen as close as possible to the measurement conditions. Incandescent lamps have been used for such calibrations for decades, but their availability is diminishing. LED-based standards would bring several benefits for calibration laboratories, photometer manufacturers, and for those using instruments for measurement of white LED lighting.

### Key research questions:

- What spectral range is necessary for LED standard sources and what composition of LEDs should be used to realize such a standard?
- What would be the best reference spectrum (spectra) based on LED products for general purpose white lighting LEDs, considering that these products are still in evolution?
- What are the alternative sources to calibrate spectroradiometers over extended wavelength ranges, including NIR and UV?
- What are the impacts due to the changes to new calibration sources and in the definition of new (standard) illuminant(s)?

## ADAPTIVE, INTELLIGENT AND DYNAMIC LIGHTING

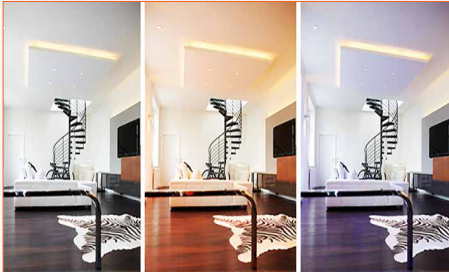

With the advent of advanced control systems incorporating LED sources, the opportunity to provide fully adaptable lighting is a significant direction being considered by industry. The term adaptive lighting refers to the changing of the light source condition, whether overall level, color, light distributions or some other metric based on the needs of the environment.

### Key research questions:

- What is the impact of adaptive lighting on user behavior or reactions, such as occupants' space perception or driver safety?
- How should the system adapt itself to the circumstances to provide the optimal lighting; for example:
  - Could the system detect individual needs for varying visual conditions?
  - Could roadway lighting vary depending on traffic composition, traffic density, and weather conditions?
- What are the relations between lighting settings and user safety and comfort?
- Which types and levels of dynamics are acceptable in a lighting installation?
- Which types of input and feedback (e.g. road surface luminance monitoring, photocells, presence detection, algorithms for integrated multi-sensor input, automated fault detection) are necessary to ensure system usability?
- What are the energy and operational costs and benefits of adaptive lighting?
- Could adaptive exterior lighting have ecological benefits beyond energy savings?

## APPLICATION OF CIE 2015 CONE-FUNDAMENTAL-BASED CIE COLORIMETRY



Since colorimetry was established in 1931, considerable improvements in the metrology of the color stimulus and immense advances in the knowledge of color vision have been made. Based on the modern knowledge of the human color visual system CIE published a set of new color-matching functions that takes into consideration the age of the observer and the field size of the stimulus, and provides a method to derive the associated chromaticity diagram (see CIE 170-2:2015).

### Key research questions:

- How accurate are cone-fundamental-based colorimetry results compared with those of 1931 and 1964 in predicting typical colorimetry applications such as color difference, color appearance, whiteness, color rendering, etc.?
- Can the cone-fundamental-based colorimetry be used to quantify the age metamerism effect and the size metamerism effect? There is an urgent need to quantify observer metamerism. Evidence suggests that the earlier CIE method underestimates these effects.

## VISUAL APPEARANCE: PERCEPTION, MEASUREMENT AND METRICS



How we perceive the world around us is clearly a fundamental part of our daily lives. It is often underestimated by individuals but for many sectors is becoming more and more significant. The overall objective of this research topic is to define metrics describing the appearance of various materials in order to support relevant stakeholders (e.g. the automotive, cosmetics, paper, printing, coatings, plastics industry, etc.). In addition to the definition of a metric, measurement tools, methods and transfer artefacts shall be provided in order to characterize modern surfaces and to ensure traceability of measurement to the SI and a reliable and well managed visual and instrumental correlation.

### Key research questions:

- What are the relevant parameters to describe appearance, gloss and translucency of various materials, including goniochromatic and sparkling samples?
- Which BRDF geometry (size, polarization, shape and uniformity of the illuminated area) according to the type of sample under investigation shall be standardized?
- If a simplified geometry is used as a standardized description of effect materials, how can the "uncertainty" with respect to the real visual appearance, i.e. the proficiency of the test method, be described?

## SUPPORT FOR TAILORED LIGHTING RECOMMENDATIONS



Individuals differ widely in visual capabilities and needs. Lighting recommendations are based on average results, usually for able-bodied young adults. A concerted research effort is required to deliver knowledge that can support specific lighting recommendations for specific populations. Two groups of particular interest are the elderly (a demographic group known to be increasing as a proportion of the population in most countries) and those with visual impairments. Other groups of special interest are those susceptible to migraine headache, epilepsy, and depression. Research in this field could lead to modifications to recommendations to aid these populations. With better knowledge, modifiers could be applied to any lighting recommendation to provide for the needs of identified groups.

### Key research questions:

- What are the age-related changes in non-visual photoreceptors (ipRGC) and neural responses? How does this change lighting recommendations for the elderly?
- Which ageing effects of the visual system are most detrimental to the performance of workers, drivers and pedestrians and how could or should this be taken into account in lighting design and requirements?
- How do visual impairments or disabilities affect the performance of people and how should these be taken into account in lighting design?

## METROLOGY FOR ADVANCED PHOTOMETRIC AND RADIOMETRIC DEVICES



In the past, CIE has published technical reports and standards defining procedures for characterization, calibration and testing of photometric and radiometric devices and measurement systems such as illuminance meters, luminance meters, integrating spheres and goniophotometers. Due to technological progress, new types of photometric and radiometric measurement devices have appeared on the market, including.

### Key research questions:

- What are the relevant quality indices to characterize advanced photometric and radiometric devices? How do these indices relate to the measurement uncertainty in typical lighting measurement situations?
- How can the measurement equations describing the measurement procedure be described?
- What would a standard measurement uncertainty budget look like for measurements on particular types of equipment?
- How can these new types of devices be calibrated? What are the best artefacts to transfer the photometric quantities to the measurement device?
- How can temporal exposures of the eye from sources that may flicker (up to about 1 kHz) or where the source and observer move in relation to each other generating a temporally changing exposure at the eye be assessed?
- How can these topics be divided into different parallel threads to improve the efficiency of the respective TCs?

## REPRODUCTION AND MEASUREMENT OF 3D OBJECTS

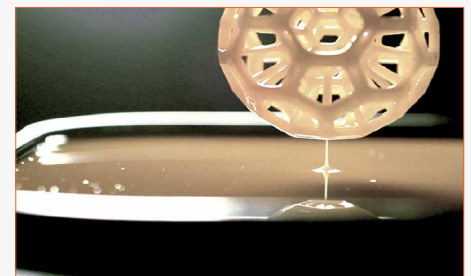

3D printing technology is one of the most revolutionary technologies in recent years. The materials used in the process are not just limited to polymers but also metals and biological tissues. This technology is used for quick prototyping, manufacturing complex 3D parts, prostheses, educational training objects and even prefabrication of housing. 3D reproduction needs to satisfy high requirements for visual attributes such as surface color, translucent color, just to name a few. Characterization of the color appearance of 3D objects requires a design software with the ability to capture both the physical properties of the materials and the visual adaption properties of the observations.

### Key research points:

- To develop the metrology of non-uniform 3D objects, including the 3D shape, the local roughness, the texture aspect and other properties impacting on the visual aspect.
- New ideas for measurement instruments and their realization for the aspect above.
- To define a set of metrological distance/similarity metrics between two objects embedding the set of differences in 3D shape, color, texture, and surface morphology.
- How to make a simple or comprehensive surface model including the physical and visual characteristics to develop the market and industry of 3D-numerical objects.
- How to reproduce the desired shape, color, appearance and texture, especially when the target surface has translucent characteristics will be a major challenge since this problem has yet to be fully solved even for 2D materials.

# Tech-Talks BREGENZ - Dr. Rubén D. Costa, Group Leader, University of Erlangen-Nuremberg



## Dr. Rubén D. Costa

Dr. Rubén D. Costa received his Ph.D. on the design of ionic transition-metal complexes for thin-film lighting sources at the Institute of Molecular Science in 2010 (Valencia). He was a Humboldt Postdoc at the University of Erlangen-Nuremberg (Germany) from 2011 to 2013, working on nanocarbon-based solar cells, and has had the position of Junior Group Leader there since 2013. His current research interest concerns the design of new hybrid materials (i.e. organic/ inorganic as well as bio-hybrid components) and their utilization in thin-film optoelectronics, in which he is considered a well-established, young researcher. This is supported by the h-index of 28 and the number of citations (>2300), publications (>80), and 19 awards/scholarships.

Light quality and costs of LED systems remain an important topic even though big improvements have been made. New approaches are always welcome and stir up hope. It was exactly a year ago that LED professional published the article by Dr. Rubén D. Costa, Liebig Group Leader at the University of Erlangen-Nuremberg, about his amazing new „Bio-Hybrid“ white LED approach. At LpS 2016 his presentation on the latest research results and improvements also won him the LpS 2016 Scientific Award. Consequently, we just had to invite him to a Tech-Talk Bregenz! In the interview below he gives us some interesting background information about why he started the project, how it works and what he expects in the future. He also gives us his views on LEDs and lighting in general.

**LED professional:** Congratulations on winning the LpS 2016 Scientific Award. Did it come as a surprise to you?

**Rubén D. Costa:** First of all, thank you for inviting me for this interview. I would also like to thank the organization for encouraging me to proceed. But to answer your question, I was more interested in the paper and not the award. I think I clicked on the entry button just by chance!

But I was eager to show this technology to the people and compare it and be fair. So my intention wasn't to win an award, but rather to share the information with the people.

The award was totally unexpected! I was sitting in the last row and had to walk all the way down to the stage. I really appreciate the fact that the paper was found worthy of winning by the advisory board.

**LED professional:** I read that you were also nominated as a finalist for "The best young chemist in the EU chemistry society".

**Rubén D. Costa:** That was very unexpected as well.

**LED professional:** Was that nomination for the same topic as you entered for the Scientific Award?

**Rubén D. Costa:** Yes and no. There are different areas for all the young chemists in Europe. If you are under 35 you are considered to be young. But they don't look at one specific scientific contribution; they look at your whole career. There were 25 finalists and each one only had 10 minutes to show them what they had achieved with their research during their career. I was lucky enough to win the silver medal here. I'm very grateful.

**LED professional:** If we come back to the LpS Scientific Award, could you tell us a little about how you did your work? Is it more experimental or theoretical? What does your workday look like in the lab?

**Rubén D. Costa:** It's a long day. Usually from 7 a.m. to 7 p.m. But the story behind it is that we started working on the hybrid technology because I had material that didn't work for solar cells and they didn't work for thin film applications. So I had to ask myself "What can I do with this material?" We thought that if it didn't work for other things, we should try something different and maybe it would work for hybrid LEDs. And then we made the decision to concentrate on hybrid LEDs. But then I noticed that everyone is doing the same thing. People have been working on this since 1997.

**LED professional:** So you had to change your plans?

**Rubén D. Costa:** I have a good friend in the group who is always asking about proteins - he was really keen on "bio". And I thought to myself, "Bio sounds good and it's complicated." So I went to a lecture by a professor from Biochemistry and he was talking about bio staff-proteins. I went to see him and asked him for the material he had and that's when everything started. I looked at the material, learned from it and then went to the lab and started testing.

**LED professional:** What have been the challenges working with proteins?

**Rubén D. Costa:** I began to think that I would have to process the material to be used for technology. But the material is in water and water is terrible for technology. And you can't work at low temperatures. But you already burn your skin at 100°C - so this temperature is already high for

proteins. That was when I realized why nobody was working on proteins. So we had to find a way to stabilize the proteins.

In biochemistry and biology, there are journals that you would never read if you are working in lighting technology. They started to show proteins that can survive x-ray radiation and you start to think, "Oh, this is amazing". And then you read that there are bacteria in the satellites. And they are outside. And this is also amazing. They are able to go up in space and then down to the earth again, and they are still alive! So you must not think about proteins only but about the whole bacteria. You have to simulate all the bacteria processes that keep it alive. If you take a small piece of the bacteria, it won't survive, but if you take the whole thing it will live.

**LED professional:** How did you manage to stabilize the proteins?

**Rubén D. Costa:** I thought that if a polymer could wrap around the protein, it would stabilize it. We did it, and it worked! But it was a very soft gel. Like a hydrogel. To make it more rigid we looked for a polymer that you can put inside with a very high molecular weight. Interacting with this branch polymer that protects the protein, it turns into rubber.

But I didn't know whether proteins were still "alive". So I went to the biochemists and asked them. And they told me that if they had color they were still alive. Because proteins without color are denatured.

To make a long story short, my students started coating everything with this rubber. They coated spoons and forks and ultimately, Nakamura's blue LED and we made green, red, orange and all kinds of colors. And then we could make it white. Surprisingly, I noticed that the rubber was always the

same color. And after a month it was still alive.

But nobody believed me. Even the core professors of biochemistry thought I was crazy. But I brought them the rubber and I brought them the LEDs because the LEDs were running. It showed that the proteins were stable. In other words, we mimicked the bacteria environment, this cell environment, where the proteins are alive by these artificial polymers.

**LED professional:** Did you have to manipulate standard proteins for the bio-hybrid LED to become fluorescent or are there natural ones?

**Rubén D. Costa:** This is the beauty of it: I didn't need to design anything. Nature did it all for us. There are colors already available for us from blue to red to infrared. Nature provided them a way to communicate with each other. Since they can't speak, they use their colors. It started a long time ago when a scientist got stung by a jellyfish. Despite the pain, he noticed that the jellyfish was green and he wondered why and how it could be.

And then they discovered a protein - called the Green Fluorescent Protein. There are other proteins with funny names like, Tomato, Zucchini, Papaya and Cherry!

**LED professional:** So in the future we won't have to buy a 435 nm LED; instead we'll buy a Zucchini LED!

**Rubén D. Costa:** Yes! Nature has provided us with everything.

**LED professional:** On a more serious note: If we talk about the conversion efficiency of proteins - is it comparable to the phosphors that are used in conventional white LEDs?

**Rubén D. Costa:** It depends on the protein. The green fluorescent are working, yes - conversion of blue LED light is quite high, actually. The red is a problem we still have to solve. What nature didn't think about are high quantum yields. But if we have bacteria with a genetic code, (I'm not saying that we can do it right now), I can think about modifying things in order to make the chromophore more stable and lock it in my protein or make

the protein more efficient in emitting light. Once you have this, production is easy. It's just two bacteria and it's going very nicely.

**LED professional:** So the major issue now is lasting stability, especially when it's exposed to the higher temperatures of the LED.

**Rubén D. Costa:** Exactly. Today, one of the challenges that we have is high power LEDs. If you ask me if we can use high power LEDs with proteins today I would honestly have to say no. The reason is because the temperatures are very high. We can reach temperatures of over 200°. Phosphors can cope with this because they are inorganic but proteins can only cope with about 120°. If you pour boiling water on proteins, nothing will happen. You can heat these rubbers to 150° and depending on the protein design, it can survive. These temperatures are upper level because the well-known proteins are stable. For high power LEDs we still have to design appropriate proteins.

Dr. Costa presented the research results of his team from the University of Erlangen-Nuremberg (FAU) at the LpS 2016

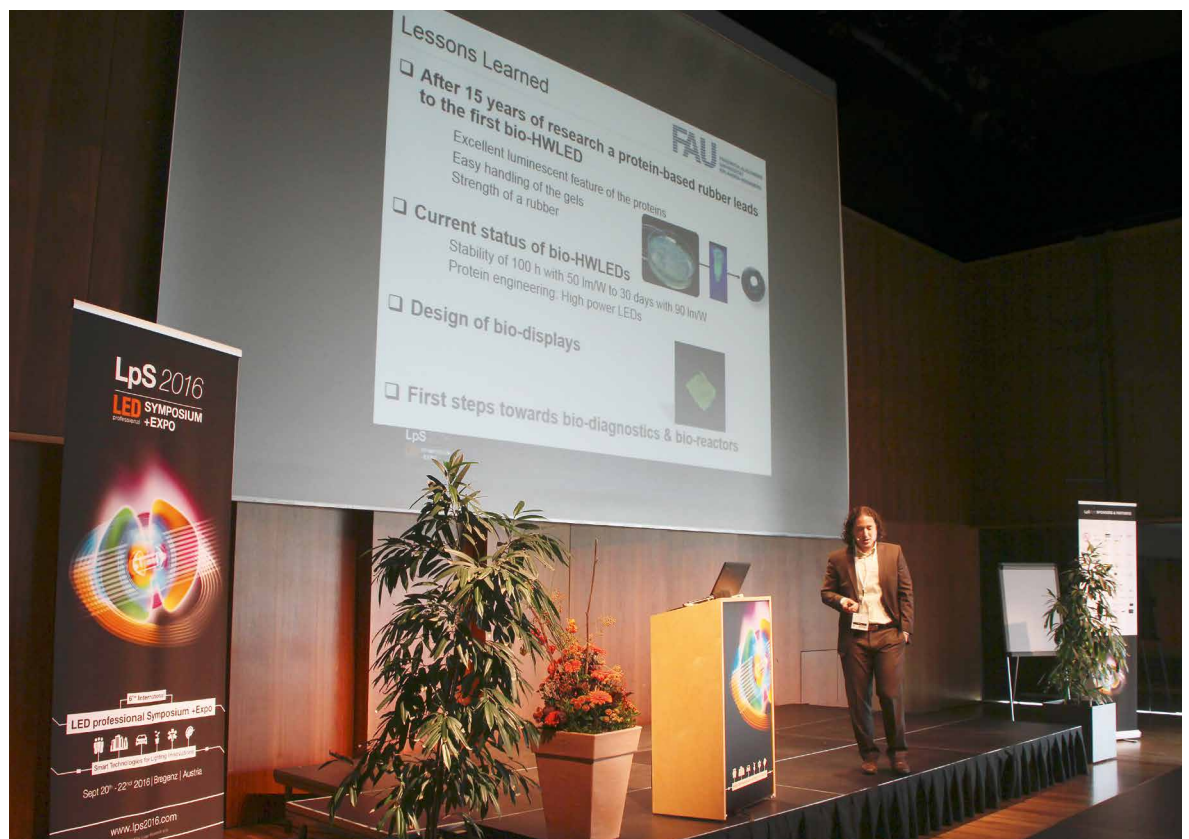

**LED professional:** If I remember correctly, in one of our first conversations you mentioned that mass production of these conversion protein systems with the rubber could be cheaper than the production of phosphors today.

**Rubén D. Costa:** Absolutely. We have to remember that phosphors are always located in mines in very specific places in the walls. You have to mine them, transport them and then process them. It is very expensive and the consumer pays for it. You also have to realize that it is a mine, and sooner or later there won't be anything left in it. But in the case of the proteins, you can produce them from the E-coli. It's a well-known bacteria; one that everybody can use. When I say everybody, I mean you - in your home, people in China, America, Brazil and Africa - can produce the bacteria and the genetic codes. Once you have them, and they are free, anybody can produce them. The good thing about the bacteria is - you put half of the sugar in your coffee and the other half you give to the bacteria. And while you drink your coffee,

the bacteria grow. OK - you do have to give them other things like amino acids, but really, what you have to give them costs next to nothing.

You grow them and they multiply. You kill half of them and take the proteins and in the meantime the other half is growing and multiplying. If you keep this going, production is extremely inexpensive. If you want a super highly purified protein to inject into a mouse or even a person, you will pay up to 200 Euros but the question is: Do we really need 99.9% purified protein for an LED? In my opinion the answer is no. So if you reduce the purity requirements the price will drop dramatically because purification is one of the most expensive parts of protein production.

Once we discover what level of purity is optimal for the LED, we will be able to calculate the cost.

**LED professional:** You mentioned that improvement for the red color is necessary. How do you think you could do that? Would you look to nature to find other proteins that have the right characteristics or

would you try to artificially manipulate the proteins to change their characteristics?

**Rubén D. Costa:** I would go in both directions. On the one hand, looking at nature and taking different red fluorescent proteins is easy. It's cheap and only a matter of one, two or three months and then test them. On the other hand, that's not a very scientific way to take everything we have and test it. But it's good to learn. Therefore, when you collect the information that we already have, you know we have this protein and it's running and it might be better than the one we usually use. Now we have to find out why it's better and how is this protein interacting with my rubber to understand it because maybe it works better because it interacts better - not because nature made something better. And then I have to find out how I can modify my matrix so that the other ones interact better. And then, we understand this manifold of data; it's the moment that we can start thinking about engineering the product. How can I make my protein interact better with my rubber? Or how can I

## bio-HWLED

**FAU** FRIEDRICH-ALEXANDER  
UNIVERSITÄT  
ERLANGEN-NÜRNBERG

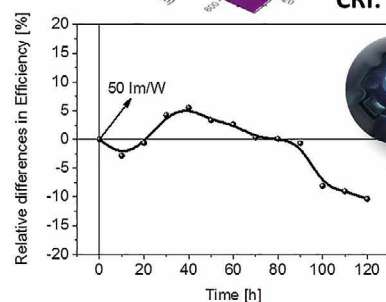
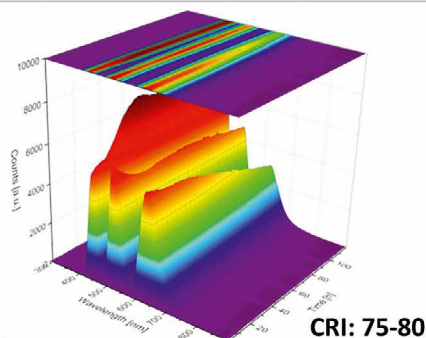
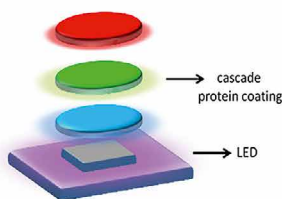

Adv. Mater. 2015 27, 5493

Patent application EP 15173026.4-1408 (positive)

The status of current "Bio-Hybrid" white LEDs was presented during LpS 2016: A cascaded RGB protein coating on blue LEDs results in white LEDs with approx. 50-90 lm/W and CRI 75-80. The graphs on the right side show the degradation of the three proteins and the efficiency decay over time

One of the latest trends in manufacturing LEDs is the emulation of sunlight at different CCT's. This is also possible with Bio-Hybrid white LEDs due to the high number of colors already available from fluorescent proteins

## bio-HWLED



### Alternatives to actual phosphors

#### ***Are fluorescent proteins interesting for optoelectronics?***

- Production is universal, low-cost, and easy to produce everywhere
- Color and PLQYs > 80 % for almost the whole visible range

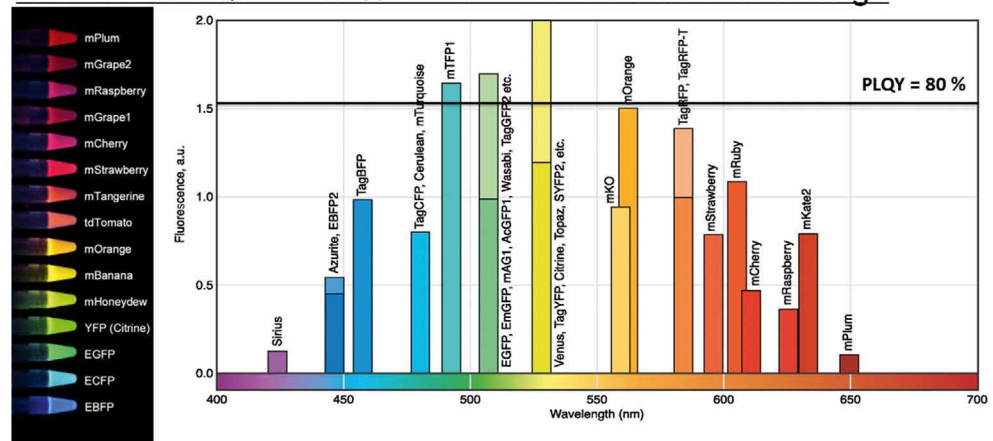

make it have high quantum yields. Bacteria can produce a lot of artificial proteins but Mother Nature never used it because she doesn't need to.

**LED professional:** Technology is often not seen objectively. At the moment, biotechnology and genetic modifications and so on, are not liked very much. So I'm wondering if people will start to worry about you changing the genome of the bacteria and think what you're doing is dangerous.

**Rubén D. Costa:** I have two things to say to that: E-coli is in our stomach. When you get sick you have lost them. We need them. We need the symbiosis with them. E-coli is also a very stupid bacterium. If it doesn't have food, it dies. If you take it out of the lab environment, it dies. We have known about E-coli since the beginning of the last century and have used it to produce natural proteins. There is nothing new about it. When you think about artificial proteins, they are fluorescent proteins - we aren't creating any viruses or producing super bacteria that will

cause people to turn green. So I have to say that it isn't harmful. And there is nothing harmful coming from these rubbers.

**LED professional:** If you look at the technology in the future and everything runs smoothly, how long would it take to make this type of technology mature?

**Rubén D. Costa:** If we start with a hundred hours of stability, which is 4 or 5 days then we stop it because we compare it to the state-of-the-art. We are scientists but we also have to think about publications. Today we have started to understand stability is in the range of months. We have to look at the application. Where is it going to be applied? I don't think it will be used for outdoor luminaires. This will take years. If we are lucky and everything runs nicely, we can say which application needs which protein in 4 to 5 years. That's my dream - my goal.

What we have today is more for indoor activities or interior car lighting. So I think that it is possible to use our technology for smart lighting. These are applications that

don't require a very long lifetime or high luminescence - so we can think about these things. Depending on the money and the manpower, I think we can fulfill all the examples I have given within a short time. But to cover the whole lighting technology on a broad basis will take us 5 to 10 years. I can't predict exactly when but I can tell you that we have made a lot of progress with this technology and we can propose new things.

On the other hand, I like to sit down with the people from the industry and let them tell me what they want. I think about stability - 100,000 hours of stability and I sit down with someone who wonders why we would need that many hours of stability. We will die before the LED does! And it's true. But - everybody wants to have that big number.

What I want is for the person to give me their problem and I will try to figure out how to solve it using the knowledge I have. If you give me the application I will look for the right protein and the right structure. Today it depends on the time, the money and the motivation.



**LED professional:** If we talk about money: Is your work already funded? Will the Scientific Award help towards getting funding?

**Rubén D. Costa:** By giving me this award you have shown me that you read the paper and thought that this is a possible new technology. It shows me that you trust me and I will try to live up to this trust. And I think that if people see that the advisory board has put their trust in me, it will help us to get funding. The award supports my work and I truly appreciate it. It encourages me to continue with my work.

**LED professional:** As a last question I was wondering what you thought of the LpS program? Was there something there for you, as a scientist?

**Rubén D. Costa:** It was fantastic being able to meet with so many different people and have good conversations. The exhibition was very interesting for me as well. I walked through it several times because I wanted to see everything. The industrial lectures were interesting in that they would look at a problem and try to solve it. I learned quite a lot. My philosophy is to go to an event with an empty box and when I leave the box has to be full: Full of business cards and full of ideas. So in this sense the program was very interesting. I really enjoyed it. The scientific lectures were great because I could see the science behind the questions. The mixture of the industrial and scientific lectures was good. My students will be very busy next week when I throw all these new ideas at them!

**LED professional:** Thank you very much for your time.

**Rubén D. Costa:** My pleasure. ■

# EPISTAR

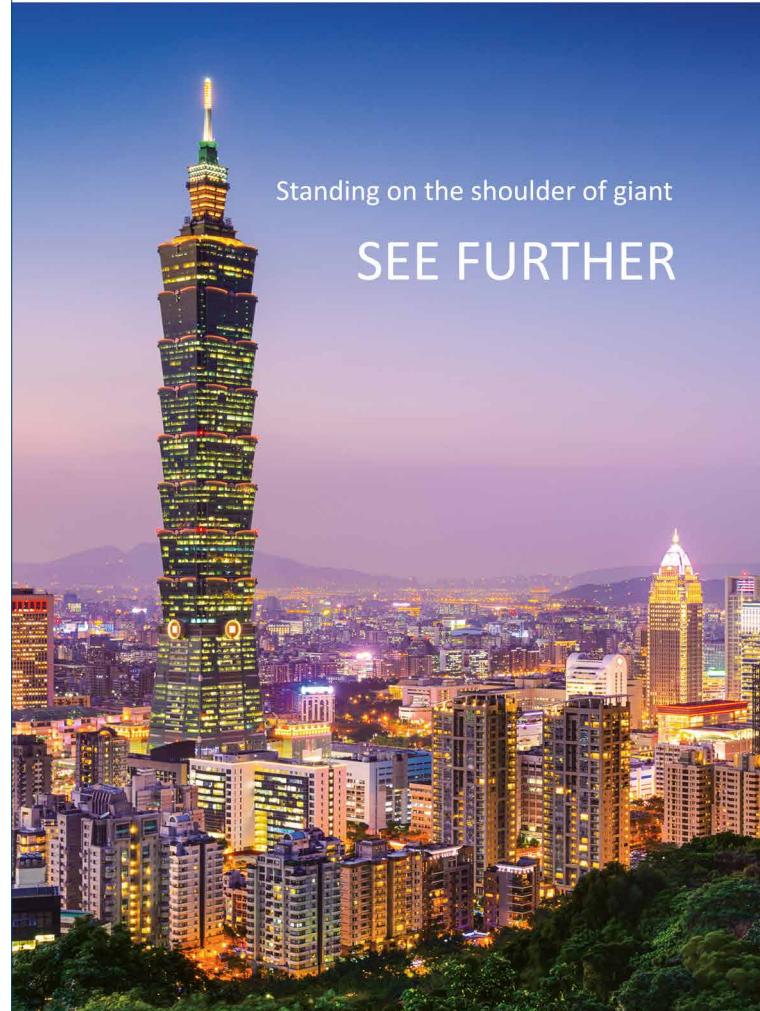

Standing on the shoulder of giant

SEE FURTHER



Learn more about our  
Co-activation Service Model



## MEET THE WORLD'S MOST RUGGED 300W LED DRIVER

**Featuring patented thermal-core  
technology for 80°C full load**

- 300 Watt CC/CV dual mode LED Driver**
- Patented thermal-core technology for -40 - 80°C full load operation
  - In-built 20kV Surge Protection option available
  - Universal AC Input
  - User Programmable Output Current and Voltage via trim pots
  - Integral wiring compartments for reduced installation costs
  - Up to 5 Channels Output (can be combined)

Visit us at Booth **LF2011**  
in Nikkei Messe Lighting Fair 2017, Tokyo, Japan  
Learn more at [www.grealpha.com](http://www.grealpha.com)



Contact us at [sales@grealpha.com](mailto:sales@grealpha.com)  
US Enquiries: (770) 538-0630  
Rest of the World: (852) 2423 3332

EPISTAR Corporation  
5 Li-hsin 5th Road, Hsinchu Science Park,  
Hsinchu 300, Taiwan  
T: +886 3-567-8000 F: +886 3-579-0801  
[www.epistar.com](http://www.epistar.com) [sales@epistar.com](mailto:sales@epistar.com)



Website Facebook

# Lifetime Calculation of White HP-LEDs from 16,000 Hours Aging Data

Accurate models are a relevant tool for correctly calculating the so-called useful lifetime predictions of LED lighting products. Until recently, only the efficiency decay and related reduced lumen output was taken into account. Max Wagner, Research Assistant, TU Darmstadt, and his co-authors, Alexander Herzog, Hristo Ganey, and Prof. Tran Quoc Khanh asked themselves if there are other lifetime limiting factors that can be modelled and predicted. Their findings showed that color shift might be more critical and in the following, propose a method to simulate and predict this behavior.

Based on the LM 80 testing standard method, the lumen maintenance of LED packages is measured during their lifetime. Ten measuring objects always run in one condition that is defined by temperature and forward current. The optical power is taken as a further criterion for aging analysis because it has a close relation to the total spectral emission. The results show that differences in the luminous flux and optical power occur during the aging test. The spectral emission of LED packages changes over time. This effect leads to a visible color shift that should be taken as a new criterion for the lifetime. Extrapolation inspections show that it is possible to find mathematical functions that correspond to the behavior of the color shift. Predictions of the color shift can be done taking early aging data and calculating them into the future. This method allows a prediction up to four times the test duration in the future. Furthermore, the author talks about relevant aging mechanisms and their dependency on the driving parameters.

## Introduction

In the last years the most important parameter of LED packages was the luminous efficacy. As there has been a high increase in efficiency, new properties like color stability are coming into focus. The author contrasts these two views of aging analysis. Besides the extrapolation methods of IES TM-21 for luminous flux, an extrapolation for the color shift in u'v'-coordinates is introduced. For every package technology (high power, medium power, chip-on-board) other aging mechanisms play the main role. Since the investigated packages are based on the principle of phosphor conversion, a deeper look into aging mechanisms in the silicone-phosphor region has been done.

## Measurement System

The investigation of aging mechanisms of high-power converted phosphor LEDs is performed under internationally accepted methodology, the IES LM-80-08. The necessary conditions and standards are fulfilled in our test setup in regard to operation currents and

applied case temperatures  $T_c$ . Two types of test samples (LED type A and B) were measured in a 30 cm integrating sphere in combination with a high precision spectroradiometer. The measurement of the LEDs is taken at a 20 ms pulsed operating current at stabilized case-temperature  $T_c$  of 25 °C. These conditions ensure a negligible influence of self-heating effects during the measurement. Furthermore, reference LEDs are used to avoid measurement inaccuracies of the system caused by dust inside the integrating sphere or aging of the spheres coating. To determine aging mechanism in dependence of the LEDs structure, two types of light-emitting diodes produced by different manufacturers were used in the test setup. Both samples have a CCT of 4000 K and a CRI > 80. Every LED-type was aged under different operating conditions, the current was set to 350 mA, 700 mA and 1000 mA, while the case temperature was stabilized at 55°C, 85°C and 95°C. Every test condition was performed with 10 LED samples up to 16,000 hours.

# LpS 2017

**LED SYMPOSIUM**  
professional +EXPO

**CALL FOR PAPERS**

[www.lps2017.com/cfp](http://www.lps2017.com/cfp)

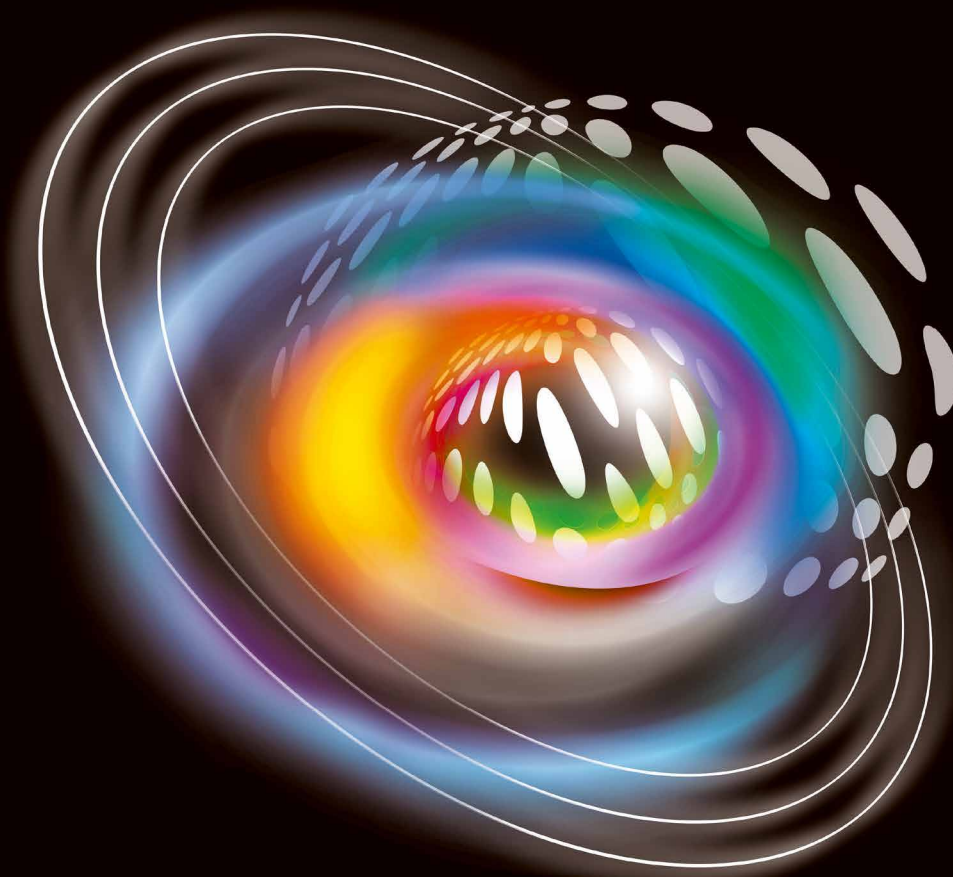

**7<sup>TH</sup> International**

## **LED professional Symposium +Expo**

**Smart Technologies for Lighting Innovations**

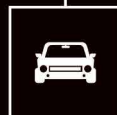

**SEPTEMBER 2017**

**26<sup>TH</sup> - 28<sup>TH</sup>**

**BREGENZ**

**AUSTRIA**

[www.lps2017.com](http://www.lps2017.com)

**Figure 1:**  
Luminous and optical  
flux for an LED package  
up to 16,000 hours  
(1000 mA, 95 °C)

## Results

### Luminous flux and TM 21 method

The TM-21 method [1] uses the luminous flux as an aging parameter. The degradation to 70% or 80% is the defined end of lifetime. Since the luminous flux is calculated with the  $V(\lambda)$ -function, spectral changes in the blue and red area are not represented as much as changes in the yellow or green area. So the total optical degradation cannot be described by the luminous flux  $\Phi_v$ , especially if the form of the spectrum changes. To get all the emitted visible light, the radiant flux is chosen that includes all spectral ranges without a weighting function. Figure 1 shows the aging behavior of an LED package (type A) up to 16,000 hours.

The blue and red curves separate from each other because the form of the spectrum changes over time. This spectral change is shown and analyzed later in detail.

The aging curve itself can be described by the following equation:

$$\Phi(t) = (\Phi_0 - \Phi_E) \cdot e^{-at} + \Phi_E$$

The formula is an exponential function, with an additional offset to the standard TM-21 function. The analysis at 16,000 hours shows a run towards a value so it is hard to extrapolate very far into the future. The lifetime of L80 was reached at 12,000 h for the radiant flux and will very likely reach it at 18,000 hours for the luminous flux.

### Radiant flux at three temperatures

The results of the aging behavior of LED type B are very different. Figure 2 shows the mean and median values of the radiant flux for a fix current of 1000 mA and three temperatures.

There are only small differences between the mean and median values, so the distribution does

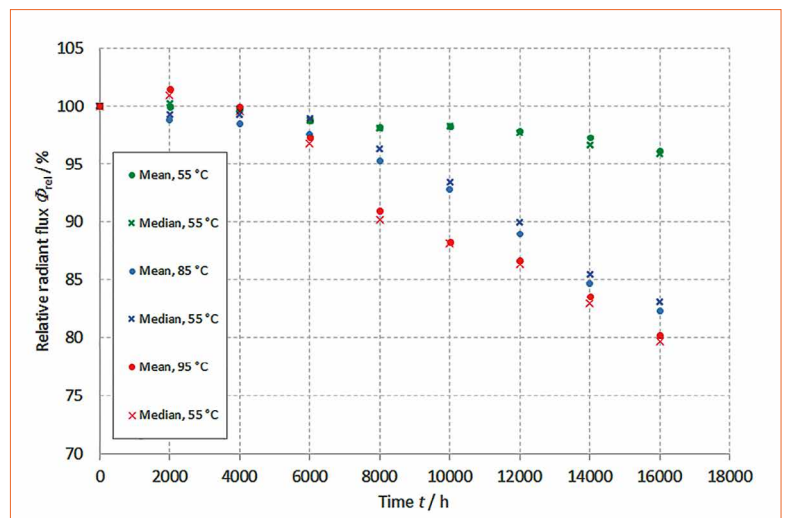
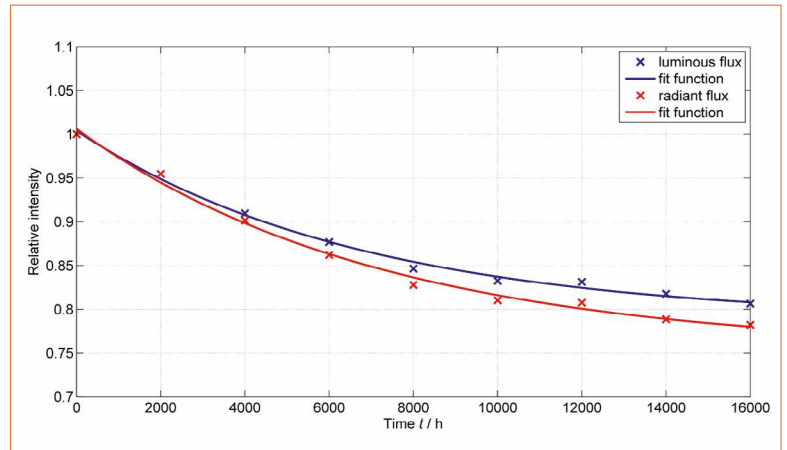

**Figure 3:**  
Silicone cap at 0 hours  
(left) and after 7000  
hours of aging at  
1000 mA / 95°C (right)



not get skewed by time. The first 2,000 hours probably contain healing effects of the crystal structure [2], which let the radiant flux rise. After the first 4,000 hours the values decrease in all conditions. There is a clear influence of the temperature (green and blue curve), a difference of 30°C leads to an average decrease of more than 10% by 16,000 hours. A further increase to 95°C results in a curve that has a step between 6000 h and 8000 h. A microscopic view (Figure 3) shows cracks in the silicone cap.

This geometric change leads to a different light extraction, in comparison to the samples at other conditions. That is why a direct comparison of the blue and red curve with regard to extrapolation is not meaningful. The results of the extrapolation with TM-21 show a higher lifetime for the lower temperature.

### Spectral changes

Normalized to the blue peak of the spectrum, there is a significant change in the phosphor-converted emission band (Figure 4).

The absolute values of the measured data, which are not presented here, indicate a loss of radiant flux in the blue spectral region and the phosphor-converted emission with different rates of change. To investigate the spectral changes in colorimetric aspects, the spectrum is divided in two spectral bands. The blue one is defined with an integral of radiant flux from 380 nm to the local minimum at 470 nm, the yellow band is set analogous between 470 nm and 780 nm.

The reason why there is a shift to warmer light is a delamination and cracking of the phosphor-silicone plate on top of the chip, which can be observed by a microscope. The interface changes and the blue light have an increased optical path through the plate. Hence, more light is converted from blue to yellow. Similar effects were noticed at other high power LEDs [3] as well.

**Color shift**

The same LED package was used to look at spectral ratios for one temperature (95°C) and three currents (350, 700, 1000 mA). For every current the ratios rise by time, but with a different velocity. The lines are the direct connections between the first and last point and correspond to the mean slope of the ratio change for every condition.

Since the spectral change is happening because of the transformation of the phosphor layer, it is helpful to know the temperature in this part of the LED package. A higher current means a higher optical radiation that is converted into heat in the phosphor layer. A direct examination of the temperature is very difficult, because of the silicone cap, which represents a barrier for thermo graphic measurements. That is why a simple model estimates the temperature by following formula with k as a temperature coefficient.

$$T_x = T_c + k \cdot I$$

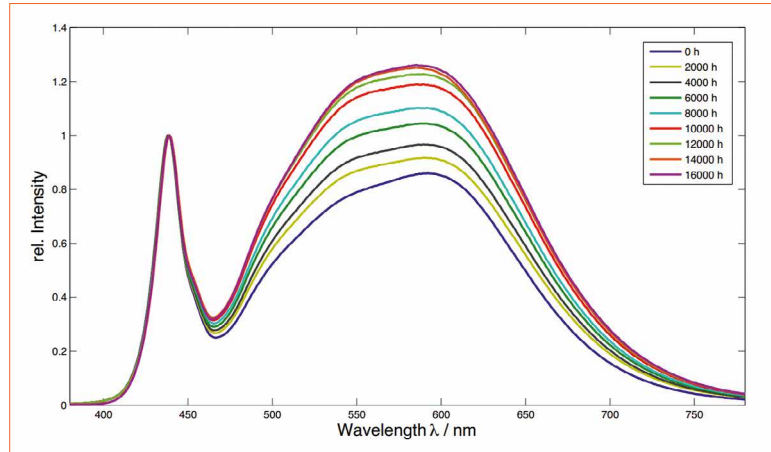

**Figure 4:** Spectral change of an LED package (LED type A) by 16,000 hours at 1000 mA / 95°C

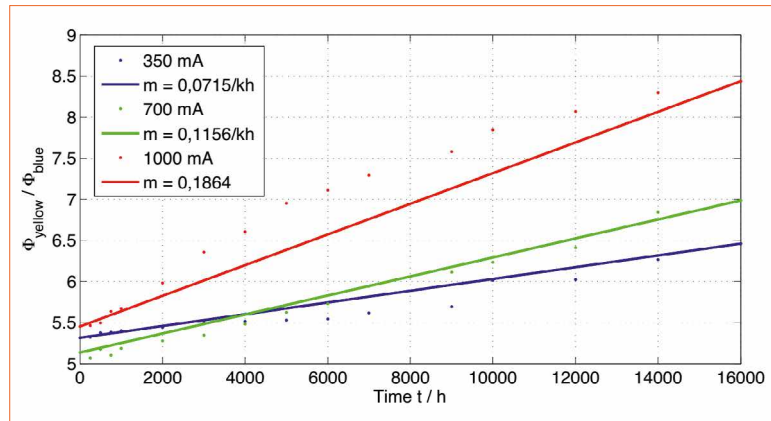

**Figure 5:** Ratio of yellow to blue for an LED package (type A) at 95°C and three currents

k \ I	350 mA	700 mA	1000 mA
0.04 K/mA	109 °C	123 °C	135 °C
0.06 K/mA	116 °C	137 °C	155 °C
0.08 K/mA	123 °C	151 °C	175 °C

**Table 1:** Estimated temperature of the silicone-phosphor layer at different forward currents

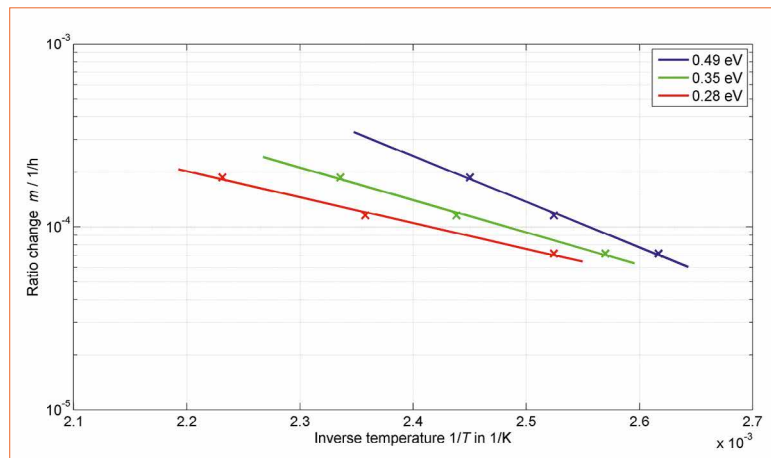

**Figure 6:** Arrhenius graphs for an LED package (LED type A) for different temperatures

The resulting temperatures of three different coefficients are shown in the following table.

Every process that is accelerated by temperature can be approached by the Arrhenius method. The semi

logarithmic diagram of the parameter to be studied (ration m) over the inverse temperature (1/T) should lead to straight lines. Figure 6 shows three Arrhenius graphs for three currents and the resulting phosphor temperatures of table 1.

**Figure 7:**  
Extrapolation of color shift (LED type A) with root functions

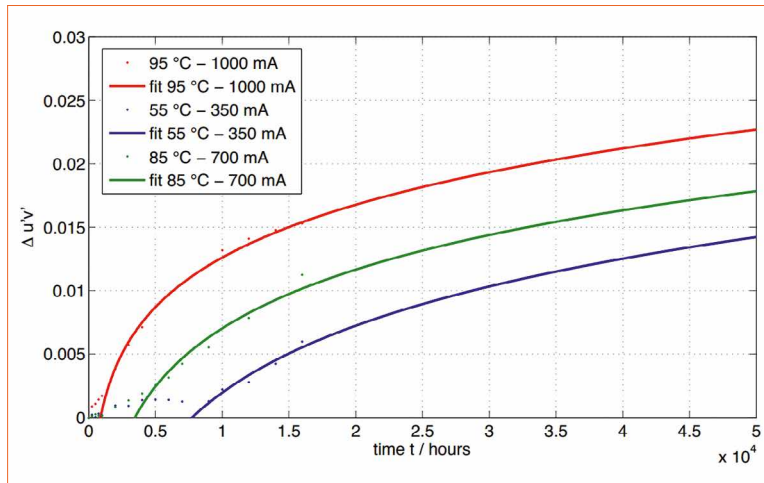

The blue points represent the lowest temperatures as the inverse temperature is represented on the x-axis. Activation energies  $E_A$  can be determined out of the slopes, the absolute temperature and Boltzmann constant. Depending on the estimated temperatures, they are in a range from 0.3 eV to 0.5 eV. That is why the exact temperature is very important for knowing the real aging mechanism's activation energies. One presumption is that the silicone matrix gets brittle over time. Accelerated aging tests of silicone encapsulant show that the elongation at breaks decreases by the factor of 10 after 4,000 hours at 225°C [4].

#### Extrapolation of color shift

In comparison to the method of TM-21 for luminous flux, an extrapolation of the color shift in  $u'v'$ -coordinates has been studied with other mathematical functions. Figure 7 shows the CIELUV values by 16,000 hours.

Interesting parameters of lighting are the  $u'v'$ -coordinates, which can be

taken to describe the color shift. Again LED type A is chosen at three temperatures and currents. The hardest condition (1000 mA, 95°C) shows the best results. The fitted function represents the values very well. As there are different start times of the strong increase of the color shift, the equation contains a Heaviside step function, so that the starting point can be calculated as the parameter  $d$ . The form of the curve can be adapted by the parameter  $a$ .

$$\Delta u'v'(t) = \Theta(t-d) \cdot a \cdot t^{0.25} + c$$

Even an extrapolation based on three points of the beginning (2,000 h - 4,000 h) ends up at the measured  $u'v'$  coordinates at 16,000 hours for different LED packages. All functions are plotted up to 50,000 hours.

#### Conclusions

The influence of current (350, 700, and 1000 mA) and temperature (55, 85, and 95°C) on the aging behavior of the LED packages is investigated over 16,000 hours.

The measured aging curves depend on the type of the package and do not always show smooth courses. Especially if new aging effects caused by cumulating processes start during the test, the data show a noticeable answer to that.

One main driving factor for the color shift is the forward current. It has a nearly proportional impact on the radiation that stresses the silicone and phosphor lying above the LED die. It can be shown that the phosphor plate is delaminating after some time. By using Arrhenius graphs the activation energy gives a hint of the process that is accelerated by temperature. Therefore the different temperatures in the package must be considered separately. Further research should guarantee a more precise determination of the relevant temperature for Arrhenius calculations. Extrapolation inspections show that it is possible to find mathematical functions that correspond to the behavior of the color shift.

Comparing the reached borders of lifetime for luminous flux (L80) and color shift ( $\Delta u'v'=0.0054$ ), a clear consequence comes out of our investigations: for some measuring objects the main problem for the LED package's lifetime is the color shift. The determination of color coordinates only requires a relative spectrum of the LED and can be measured by small, hand held devices. So it could be possible to analyze the color shift of more products without complex laboratory equipment. ■

#### Acknowledgements:

The authors want to thank to the German Federal Ministry of Economic Affairs and Energy for the financial support of the project.

#### References:

- [1] IES TM-21-11: "Projecting Long Term Lumen Maintenance of LED Light Sources", July 2011
- [2] Yang, Y. et al., "Acceleration Factor Analysis of Aging Test on Gallium Nitride (GaN)-based High Power Light-emitting Diode (LED)", 14<sup>th</sup> IEEE ITherm Conference, 2014
- [3] Tuttle, R., "Method for Projecting Color Shift of High Power LED Packages", 4<sup>th</sup> LpS, Bregenz, 2014
- [4] McDonald, J., "Advanced Silicone Materials for LED Lighting", DOE SSL R&D Workshop 2015

# Lighting the World ONE LED AT A TIME

## 757GT-V1 Mid-Power Series



Balanced cost and efficacy

Superior reliability

Low thermal droop

3-step, 5-step and kitted MacAdam Ellipses

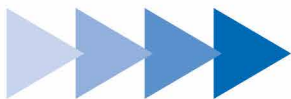

**Request Your FREE Samples Now!**

[www.bit.ly/FLSNichiaSamples](http://www.bit.ly/FLSNichiaSamples)

Available in Europe and the Americas



[www.NICHIA.com](http://www.NICHIA.com)



*Making LED Lighting Solutions Simple™*

[www.FutureLightingSolutions.com](http://www.FutureLightingSolutions.com)

# LuxLive and SILE Sharpen Focus on End-Users

On November 23<sup>rd</sup> and 24<sup>th</sup>, as in previous years, LuxLive was held in the Excel Center close to London's City Airport. This year, for the second time since the merger of Revo Media and Pennwell, LuxLive and Strategies in Light Europe were co-located. Arno Grabher-Meyer, Editor-in-Chief at LED professional, summarizes his impressions of the event, picking out the more technical oriented lectures held in the different "arenas".

Most of the traditional luminaire and system providers for the UK market and many companies that want to break into the UK market were present with upmarket booths. A broad program, from free accessible presentations on different stages in the exhibition to lighting designer, installer and building manager focused, and application related presentations in LuxLive's "tech arenas", and two SILE tracks provided more strategic and technology overview topics.

While the end-user focus isn't as relevant for technicians, the secondary activities included some appealing lectures. The huge number of contributions made a strategic selection most important for visitors and attendees alike. However, to provide the most relevant information for the LED professional readership, my task was clear: Select the more technology focused sessions, lectures and activities to gather valuable, detailed information. And listen carefully to the keynote speeches held on Wednesday morning in the SILE conference area, to get an idea about the event and its aims.

## The Keynote Sessions

The heartfelt greetings by Philip Smallwood, Director of LED & Lighting Research at Strategies Unlimited and Geert van der Meer, SVP & CEO Business Unit Digital Systems at Osram, geared the audience up for the event.

Mr. van der Meer explained how the World Wide Web has changed the world, allowing smart infrastructures. He also delivered some thought-provoking ideas when he showed that today's buildings use 50% less energy per square meter than they used in the 1970's but this progress is over-compensated by the fact that the building area per person has increased by approximately 400%! He believes that this situation calls for intelligent building management that could be accomplished by lighting infrastructure enabled IoT. He explained that currently the monthly costs of a building per square meter in big cities are: €3 for energy, €30 for rent, and €300 per person/user. Based on this 3-30-300 rule, he clearly sees services far beyond energy savings or pure space management as a business case for the lighting industry. Consequently, the biggest savings can be generated when managing the last cost factor most efficiently. One proposed solution is "biological lighting" which could easily increase human efficiency by 10%.

In the following speech, Dominic Noel-Johnson, Vice President at Green Investment Bank, emphasized that financing strategies and models clearly lag behind the development of LED technology. He stressed that replacement will most certainly happen but it could be faster with an appropriate financing strategy and services. He believes that one of the reasons for this situation is that the public hand does not have the money to invest. Another reason is that single lighting projects are much too small for third party financing from organizations like his bank. Investment companies are used to dealing with projects like offshore wind power plant financing.

The third speaker in the first part of the keynote session was Dr. Falk Meissner, the CSO at Lumileds. Dr. Meissner showed market figures for the component business. After a flat 2% phase from 2014 to 2016, he expects it to increase to 4%-5% in the coming years. He stated, however, that figures are far below earlier predictions. He also showed which application areas the growth will be fostered from. The biggest drivers are younger LED lighting applications like horticulture and animal farming while the established applications are seemingly reaching a saturation point. Concerning the business environment, he said that while the last few years have led to a



consolidation in the semiconductor business, he does not see that in the near future for the LED and lighting business. On the contrary, he expects even more fragmentation.

After a short break, Diederik de Stoppelaar, Secretary General of LightingEurope, presented the position of the organization on different political decisions and trends that are relevant to the lighting industry. He emphasized the organization's main goal to make sure that an "equal major playing field" is provided for all participants in the European and world-wide lighting market. He sees a clear necessity to proceed towards intelligent lighting that provides true human centric light as defined in the SSL-erate program. HCL is lighting designed to increase vision, well-being and the performance of humans. He also reminded the industry of the importance of a circular economy and the need to come to a new understanding on that issue, even when the lighting sector is doing quite well.

Gordon Routledge, Chairman & Publisher at Revo Media, asked in his distinctive, subtle, but provoking manner just what went wrong with LEDs. He suggested killing the light switch and compared today's approach to building LED luminaires with playing with LEGO blocks. He emphasized the opportunities IoT brings with it and also warned of the possible threats. Gordon Routledge ended his speech with the words, "No good stuff for free. Stop the bad stuff!"

Philip Smallwood returned to the stage to close the keynote session. While his figures were slightly different, he basically outlined a similar picture of the business and market situation as Dr. Falk Meissner did, with horticulture lighting being the major growth segment. In addition, Mr. Smallwood suggested that lighting could become the backbone of smart cities.

## Lectures with Technical Content

While there weren't many lectures with a deeper technology focus, the ones I attended were particularly enlightening. Three speakers and lectures are especially worth mentioning due to the way they provided a good understanding of the current situation and status of three very different technologies.

Plessey Semiconductors' CTO, Dr. Keith Strickland, gave his insights on GaN-on-Si technology, the current status and where he sees the biggest advantages. He said that although GaN-on-Si LED technology development was developed much later than GaN-on-Sapphire, and therefore had some performance disadvantages at the beginning, this deficit has been compensated for and the technology offers a performance on par with today's standard for conventional LEDs. While GaN-on-Si LED production needs some extra process steps to avoid lattice defects due to strain, the costs can be held lower, especially because of the bigger wafer size. Plessey and most of their management and development team already have a long history in manufacturing Si-based semiconductors, namely mixed signal ICs before ramping up LED business. This knowledge and the Si-based technology allows the integration of additional components; currently mainly for ESD protection (Zener diodes) and photo diodes. The technology is also said to have advantages when it comes to the design of multi-junction high voltage LEDs and larger devices. Single chip LEDs of approximately four times the size of conventional LEDs are no issue. The further advantages that Dr. Strickland sees are the design of so-called micro LEDs and the integration of optics to produce chip scale packaged (CSP) optics.

Dr. James Norman Bardsley from Bardsley Consulting, who is also the leading technology analyst for DoE and ISA, talked about the future of OLEDs. At the beginning of his talk,



he emphasized that the lighting industry should probably not try to escape from lighting into IoT based services because there are many, much stronger competitors. Instead, he felt they should deliver better, valuable technology that the client is willing to pay for. For the future of OLEDs, he sees light and shadow. In some applications OLEDs already have some distinctive technical advantages over LEDs. At the same time they still have huge drawbacks in many aspects, especially when it comes to efficiency and costs. The reason for the enormous performance drawback is primarily the very low extraction efficiency. While internal quantum efficiency is already at about 65%, extraction efficiency is at approximately 35%, leading to a wall-plug efficiency of maximum 18%. While, for example, big displays, up to 55 inch TVs, are presented and may reach an acceptable cost point soon, these costs will still be much too high for lighting applications. Therefore, he sees the near future more in OLED displays with the technology transforming later into lighting

**The presence of companies like CoeLux, with their innovative lighting solutions, and other luminaire manufacturers support the end-user approach of the event**

Apart from praising the well-known theoretical business options, Tom Griffith came with a clear picture of practical and technical solutions

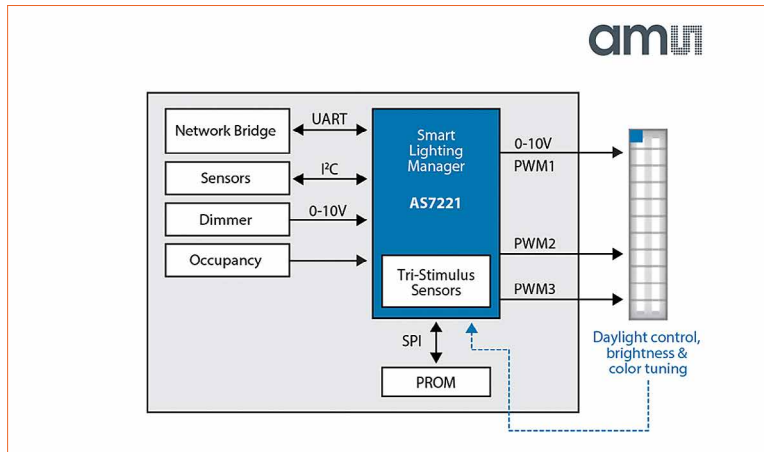

products. The general observation that OLED development lags behind the earlier forecasted roadmap demonstrates the complexity of the technology, especially when it comes to mass production and the cost-effective roll-to-roll and printing process. This helps to understand why, for example, Konica Minolta still has no mass production product after demonstrating very promising prototypes almost two years ago. For more information on this hot topic, we will be publishing the LED

professional Tech-Talk Bregenz with Dr. Bardsley in LpR 60 (the March/April issue).

John Peek, Senior Advisor at Soraa Laser gave a detailed look at what visitors to the LpS 2016 already heard from Prof. Shuji Nakamura. One of the important aspects for laser lighting is Soraa's semi-polar laser technology. One big advantage of laser, especially GaN-on-GaN grown semi-polar lasers, is the high efficiency at high currents that is not negatively affected by droop. Another is the extremely small size of the light source that leads to an extraordinarily high luminance. Mr. Peek also showed which concepts of laser lights are possible and what the advantages and disadvantages are. From Soraa's point of view, there is one concept that incorporates the most advantages. It satisfies the safety requirements and allows for proper thermal design. While costs are still too high, it is expected that they will decrease to a reasonable price-point soon, due to the higher yield per wafer compared to LEDs of a similar luminosity.

Tom Griffith, ams/TAOS' Senior Marketing Manager, demonstrated their latest achievements in sensor technologies, namely: Miniaturization and higher integration. This makes sensors cheaper and has positive effects on system costs. He also stressed that it is all about taking the first step of comparing lights with smartphones. The huge numbers of sensors that are required for them made the

sensors cheaper, and there are many more luminaires sold per year than smartphones. When the first smartphones were introduced virtually, no apps (which offer the true value) were available, but the number of apps exploded in a short time. He predicts the same will happen for all IoT enabled applications. From a hardware perspective, highly integrated chip-level solutions are already available, and even higher integrated solutions are to come. Tom Griffith also explained that usability to not only pertains to lighting and reducing energy bills, but it goes far beyond that. The time for baby steps is over when entering this business today. A respectable amount of leaps of faith are now necessary.

### Highlight of the "Arenas" on the Exhibition Floor

Technicians would find some of the lectures and demonstrations that were presented in the "arenas" throughout the exhibition area, interesting. Ken Munro, an ethical hacker at Pen Test Partners, gave an "outstanding performance" (for lack of a better word). The demonstration of different IoT enabled products was great fun to watch, and at the same time, Mr. Munro provided information about which links in the chain were poorly designed or programmed, leading to vulnerability. The following points are taken from his long list of advice. He pointed out that it is very important to design IoT devices to allow the company to make updates using push communication technology. One big issue is that apps request rights for unnecessary information and hardware, storing unsecured data. He also said that hardware design is critical. It is not sufficient just to leave out the debugging and analysis sockets because the empty pins still offer easy access to the software for reverse engineering. It was simply amazing how easy many devices can be hacked if you know what you are doing. But he also emphasized that any IoT product would be relatively safe if the clear

The demonstration of ethical live hacking was an eye-opener. While IoT can offer enormous benefits for all users, industry has to do it right in order to avoid havoc



### Failure to Synchronise the Circadian System

- |   |                      |
|---|----------------------|
| <ul style="list-style-type: none"> <li>• Loss of Attention</li> <li>• High level of Micro-Sleeps</li> <li>• Failure to process information</li> <li>• Impulsivity &amp; Loss of Empathy</li> <li>• Memory Impairment</li> <li>• Reduced Cognition and Creativity</li> </ul> | <b>Short-Term</b>    |
| <ul style="list-style-type: none"> <li>• Immune Suppression</li> <li>• Increased Infection/Cancer Risk</li> <li>• Increased Cardiovascular Disease</li> <li>• Risk of Diabetes II</li> <li>• Metabolic Syndrome</li> </ul>  | <b>Long-Term</b>     |
| <ul style="list-style-type: none"> <li>• Mood Instability</li> <li>• Anxiety</li> <li>• Increased Stimulant/Sedative Use</li> <li>• Increased Risk of a Mental Health Crisis</li> </ul>   | <b>"Psychiatric"</b> |

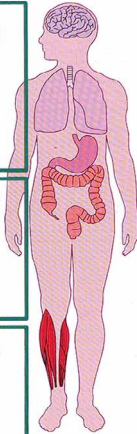

trigger the circadian rhythm need to be properly considered. The findings about short-term effects, long-term effects and "psychiatric" effects are food for thought.

Prof. Foster identified many effects that are induced by failures in circadian synchronization

### Final Thoughts

The event is increasingly following an end-user approach and absolutely fulfills this self-imposed goal. It is absolutely valuable for designers, installers and building managers. But what is it for technicians? Well, a strongly technology focused event will provide more technical input, but it is also not wrong for technicians to think outside the box and to understand what the markets and applications require. Therefore it is worth keeping LuxLive in mind and watching the program announcement carefully. There are certainly also some interesting contributions with a technical focus. LuxLive is certainly a meeting point for the lighting industry. ■

design and programming guidelines of the used standards and protocols would be recognized.

Professor Russell Foster of the Oxford University held another noteworthy presentation in the "lightspace dot". It was very interesting to find out how he and

his team found the so-called "third receptor" in the eye and his information about the effects of disturbances of the circadian rhythm is a must-know for everybody working in the lighting business. Especially revealing were his remarks about how intensity, illumination duration and color to

# InterLumi

The lighting trade fair can be your local partner

## Panama

## June 29 – July 1, 2017

ATLAPA Convention Center, Panama

[www.inter-lumi.com](http://www.inter-lumi.com)

Light up the path to

# The Latin American & Caribbean Market!



# Swiss Photonics Workshop on Intelligent Efficient Solid State Lighting

Swiss Photonics held their Swiss Solid State Lighting Workshop in the Pantheon at Muttenz near Basel on December 12<sup>th</sup> of last year. The ambience of the automobile museum was perfect! The program covered a broad range of topics including Human Centric Lighting, Internet of Things and the results of the LASSIE project (Large Area Solid State Lighting Intelligent Efficient: A 7<sup>th</sup> Framework Program for Research and Technological Development). In the following article, Arno Grabher-Meyer, Editor-in-Chief at LED professional, summarizes the highlights.

Around 100 specialist, members and interested parties accepted the invitation and attended what turned out to be a very informative workshop. Because this was a follow-up event to the Large-Area SSL workshop held in Lausanne in 2015, the main focus of the morning was on the LASSIE project. In the afternoon, however, information on the more general and extensive topics of HCL and IoT was provided. Renowned speakers from the DACH region (Germany, Austria and Switzerland), as well as experts from The Netherlands, Finland, Sweden, Belgium, France and Spain all shared their knowledge with the attendees.

## A Warm Welcome

Dr. Christian Bosshard opened the workshop with a short welcome and an introduction to Swiss Photonics, after which, Dr. Christoph Kloepper briefly introduced the Basel area in respect to technological and innovative power. He explained that Switzerland, in general, and the Basel area in particular, have the highest innovation indices in various international innovation reports. It isn't a coincidence that CSEM, which is located in Muttenz, coordinated the LASSIE project and substantially contributed to the outcome of the project.

## Large Area Intelligent Efficient SSL - Focus on the LASSIE-FP7 Project

Dr. Rolando Ferrini introduced the audience to the topic and the objectives of the LASSIE project before divulging details, results and technologies of the Large Area Intelligent Efficient SSL project. Large area lights are an extensively used product in commercial lighting applications. While conventional troffers already do quite a good job, modern technology could do it even better with some additional, integrated features. However,

before the project kicked off, costs for high quality solutions were quite high and the true potential of modern technologies wasn't being utilized by far. At that time, although OLEDs were a very good candidate for this type of lighting, they weren't price competitive, and still aren't. There are also other challenges like beam shaping. On the other hand, LEDs were still costly and had their own disadvantages. The challenge that had to be overcome was to find a concept for a thin fixture that would offer high light quality and color, or at least CCT tuneability, at a reasonable price, while having a small environmental footprint. Dr. Ferrini gave a short overview of the key technologies that were used in the final concept and summarized the major achievements, which include a high CRI above 90 with high color accuracy within 3 to 1 step MacAdam ellipsis and constant color over time due to an intelligent sensor feedback loop.

Senior project leader, Oscar Fernández talked about the optical requirements and solution for the project. For those that attended his talk at the LpS in Bregenz, this was a repeat, but a good opportunity to refresh one's memory. First he made

a quick comparison of expensive OLED lights and LED solutions. It was shown that glare is a much bigger issue with LEDs. But there are two very different concepts possible for LED area lights - both with advantages and disadvantages. Edge lit LED luminaires are a thin but heavy option. They provide moderate light uniformity, lower efficiency and a large color shift across the emitting area. Conventional, direct-lit luminaires are lighter and more efficient but either add volume to the luminaire because of the greater distance needed between the LEDs and the diffuser, or they produce undesired multi-shadows. To avoid or reduce that, the Lambertian emission needs to be changed into cosine-cubed batwing light distribution. This is usually done with bulky and heavy "macro" lenses that add volume and costs to the system. Thin films for free form structures could be an alternative solution but must be tailored with a large degree of freedom in mind. The proposed solution: periodic microstructures,

### Light recycling prismatic foils

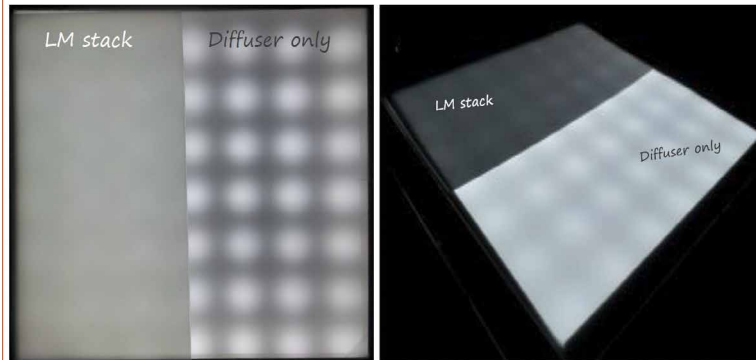

Property of the LASSIE-FP7 Consortium

and especially "micro-structured pixel", are a much simpler solution. These can be cost effective, roll-to-roll processed foils that help to reduce the number of LEDs needed. Such foils are already in use as light enhancement foils in LED displays. Using two rectangular foils in position with a diffuser, leads to the desired result: a flat, thin, highly efficient and cost-competitive area light where variations and further adaptations are possible. While a color tunable

multi-LED solution significantly increases the cost, low CRI LEDs can be used with a down-converting phosphor sheet resulting in a high CRI solution with a reduced cost.

Dr. Stephan Junger from the Fraunhofer Institute presented a new CMOS technology based sensor concept that helps to add intelligence to color tunable luminaires at reasonable costs. While conventional sensors are usually designed with some type

Comparison between the LM stack that was developed in the LASSIE project and a pure diffuser foil on a thin area light

Demonstrator and development board for Fraunhofer's integrated sensor using plasmonic filters

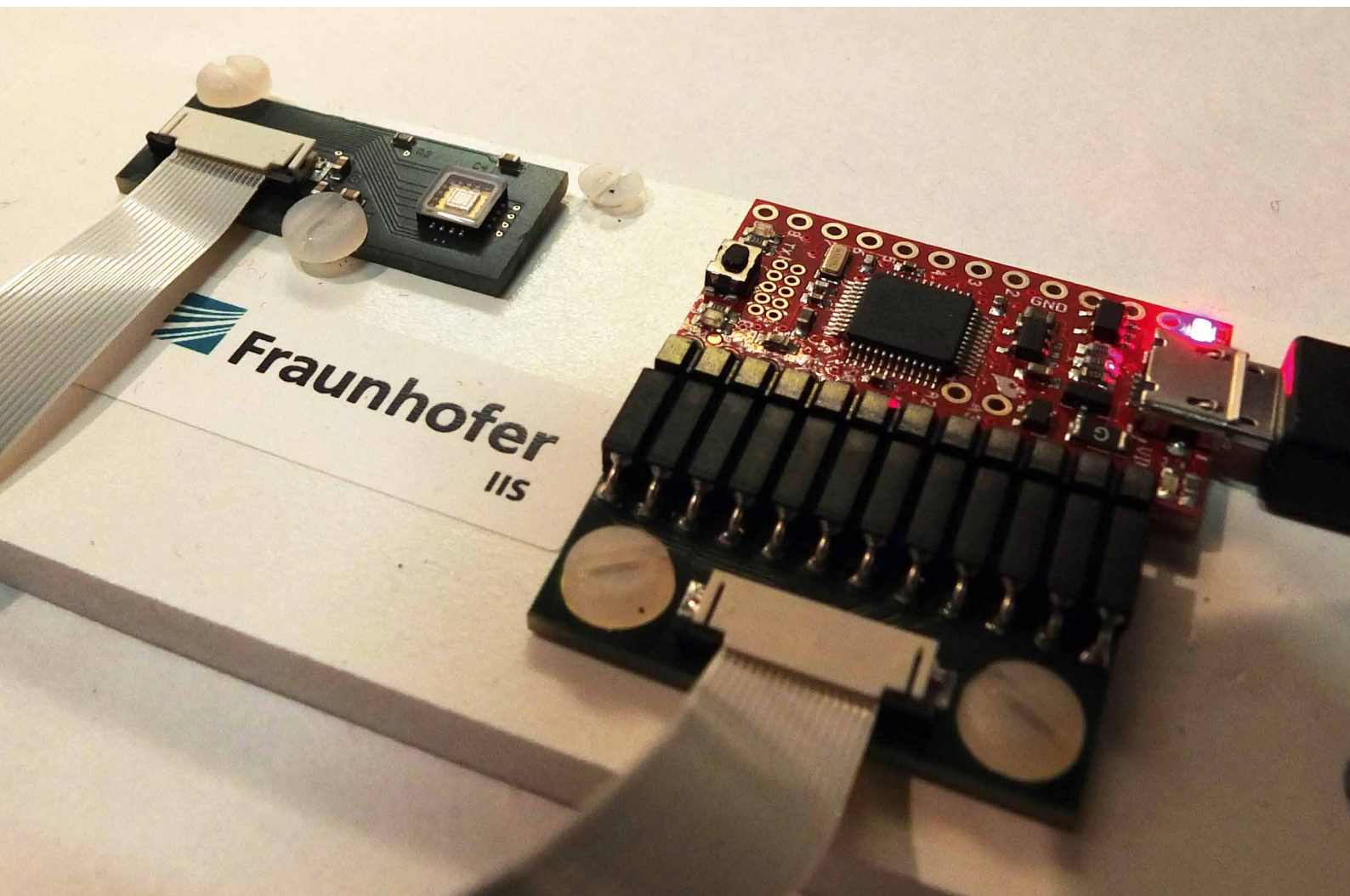

**Life Cycle Thinking has been recognized in the EU as the most suitable methodological framework for most product and process related sustainability discussions**

of pigment filter or interference filters and are restricted to RGB or, rarely, RGBW, this concept is different. It uses a nano structured metal layer as a so-called plasmonic filter. This technology allows designing a photodiode array of 12 channels between 400 and 700 nm in a 5x5 mm package. The LASSIE project was ideal to prove the concept and test the accuracy of the approach. It also helped find out how many different channels are really needed to provide high accuracy at optimized costs. Fraunhofer found that this technology could provide sensors with a cost target of €1 in high volume. Compared to that sensors with similar functionality are currently not available below €2.

VTT is a research institute in Finland with a lot of experience in R2R manufacturing processes and flexible substrates. Senior Scientist, Dr. Kimmo Keraenen, described their role and tasks within the project. One key issue, as is very often the case, was thermal management. They compared different technologies, rigid and flexible, and finally found a suitable solution for their printed R2R technology that led to excellent results for this application. A PET substrate was perforated using a USHIO mechanical puncher and wafer diced ceramic/metallic foil pieces were bonded to these vias. Circuit wiring and contact areas were printed with silver ink. While the cool white LEDs were bonded on pads with the heat management structures below, the color LEDs were bonded on contact pads without heat management structures. Necessary wire crossings were enabled by zero Ohm resistors.

Leire Barruetaña from the Spanish specialist for environmental management and life-cycle assessment, Gaiker, explained that new regulations and economic efficiency require having a life cycle assessment in mind from the beginning of a project. According to her findings, an efficient design is

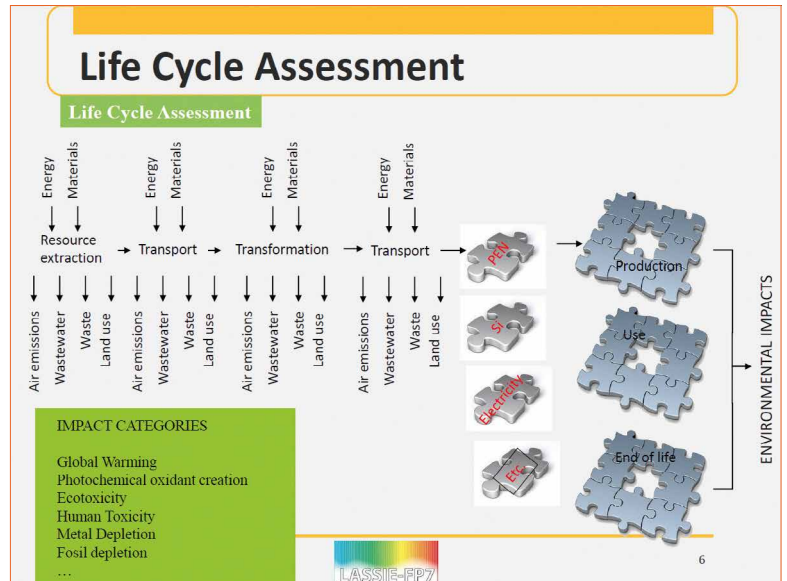

still key for an environmentally friendly and cost-effective solution. 85% of CO<sub>2</sub> is generated during the use-phase of an LED product. Therefore better efficiency has the greatest impact. The major cost driver is still the LED package, respectively, the number of used packages. More efficient LEDs can reduce cost and simplify design owing to a reduced number of LEDs.

Dr. Adrian von Mühlennen, representing the Technology Incubator of BASF Switzerland in Basel, showed an interesting approach to down-convert white light of low CRI to generate a high CRI white light. The R2R manufacturing based technology is still in a research state and therefore just basic information and preliminary results could be disclosed at the workshop. A strategic decision if and when the technology will be transformed in a standard product, still needs to be made.

Christian Hochfilzer, Technical Director at Regent, emphasized that technology is no longer the main driving force behind the lighting evolution. He demonstrated that intelligence and system integration are relevant success factors. Contemporary lighting concepts need to be flexible, and IoT has an important role, providing new services. Dr. Hochfilzer identified IoT as being a complicated and critical strategic topic. The choice of the

right technology from the bunch of competing approaches is especially crucial for small to mid-size companies to hold their own in the marketplace of the future.

The session was then completed with the talk of Peter Bennich, Senior policy adviser (at the Swedish Energy Agency); chair of the IEA 4E SSL annex. He explained the background, the goals and the activities. One of the challenges in reaching the goals is seen in the harmonization, recognition and acceptance of standards and regulations, worldwide. In a first step testing methods and results were compared. He also emphasized the reaction of the 4E on new circumstances. Smart lamps have a great impact on energy use and active functions often need more than pure standby energy. In some cases, these standby losses exceed active energy consumption of 3 hours.

### Smart & Human Centric Lighting - Technologies, Bio-physiology and Application

EPIC's Director General, Carlos Lee, chaired the session that was characterized by exciting discussions and Q&As. The session started with Exalos' CTO, Markus Duell, who gave a status report on the Superluminescent Light Emitting Diode (SLED) technology and prospects for future

development and possible applications. In many aspects, visible light SLEDs are combining the best of both technologies, LEDs and SSL lasers, but they also have their weaknesses. The major disadvantage is not being powerful enough for most lighting applications today. Improvements are possible, but will take time.

LETI's LED and OLED technology and business expert, Hani Kanaan, talked about "Micro LED Matrix for Smart Lighting System and Automotive Headlamps Applications". The technology distinguishes significantly from conventional LED technology. Currently, the smallest pixel size is 2  $\mu\text{m}$ . Multi quantum well technology is used to generate different colors and could allow for color tuning applications. While being especially interesting for display technology, there might also be a certain potential for smart and human centric lighting applications.

Enno Langendijk from the TNO Holst Center presented the PI-SCALE project. Visitors of the LpS 2016 in Bregenz might already be familiar with the project that deals with establishing a pilot line for R2R production of flexible OLEDs. The aims of this project are to help speed up the transition from lab to commercialization for Europe's lighting and OLED industry - bridging the gap.

Beat Ruhstaller, Chairman at Fluxim and Professor at the Zurich University of Applied Sciences, talked about "Design, Characterization and Optimization of OLEDs for Lighting". Using his research results, Professor Ruhstaller confirmed statements by Professor Kido that were discussed at the OLED track of LED Lighting Japan in 2014 (see LpR 42 Event Report: Lighting Japan - Strong Focus on OLEDs). Furthermore, he analyzed the different challenges from conductivity issues to light extraction to angular dependency of light color. He showed how manufacturers deal with these types of issues today. Regarding light outcoupling, he

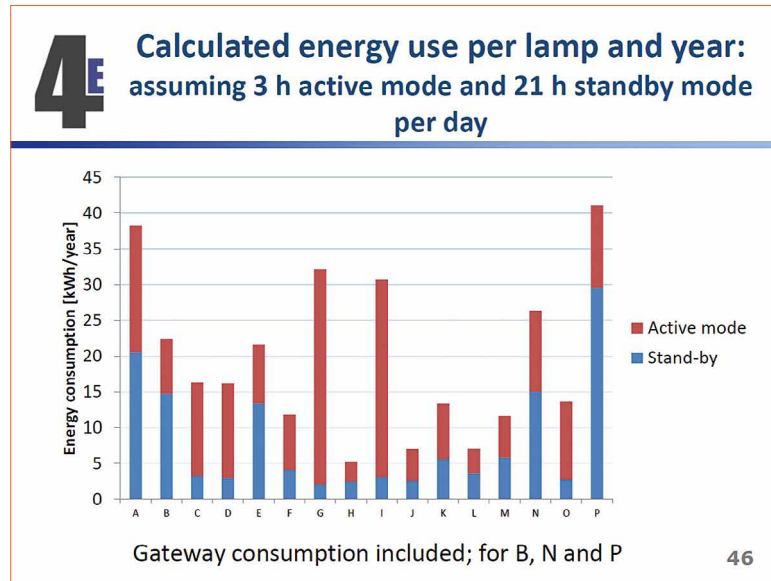

Smart lamps may use more energy in standby mode than during the active phase



While flexible OLEDs can be customized to virtually any shape and color, they are still facing technical challenges

presented a highly accurate simulation model, compared the efficiency of an internal light extraction structure with an external light extraction structure and the combination of both. Using two rough interfaces increases the emitted lumens by a factor of 2.1.

The last part of the afternoon session focused on the different effects of light on humans. Professor Cajochen, who gave a presentation in a workshop at the LpS in Bregenz and whose findings were discussed in the TTB interview in LpR 58 - Nov/Dec 2016 issue, gave the audience the current status of this research discipline. He explained the circadian system and Melatonin rhythm in detail and presented alarming figures about smartphone

use in adolescents (14-20 years) which is one of the most critical light sources with high melatonin suppressing light levels besides computer screens. Due to the distance, he feels that TVs don't have such critical effects. He also showed that a lux level of 120 lux has acute alerting effects on humans. Declarative learning effects test results for correctly identified new word pairs were significantly better when LED screens were used while correctly identified old word pairs showed almost no difference between LED screens and non-LED screens. Professor Cajochen emphasized that light is not just for vision but has many non-visual biological effects on humans, some of which are still not fully understood. He asks that non-visual lighting

The use of smartphones in adolescents that might carry some health risks clearly shows how technology influences culture and behavior

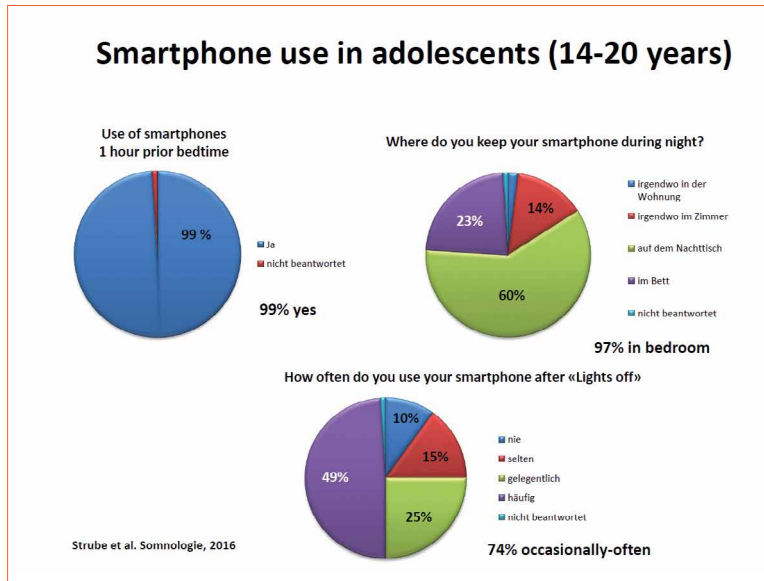

Different light scenes for HCL in a hospital depending on the time of day and task

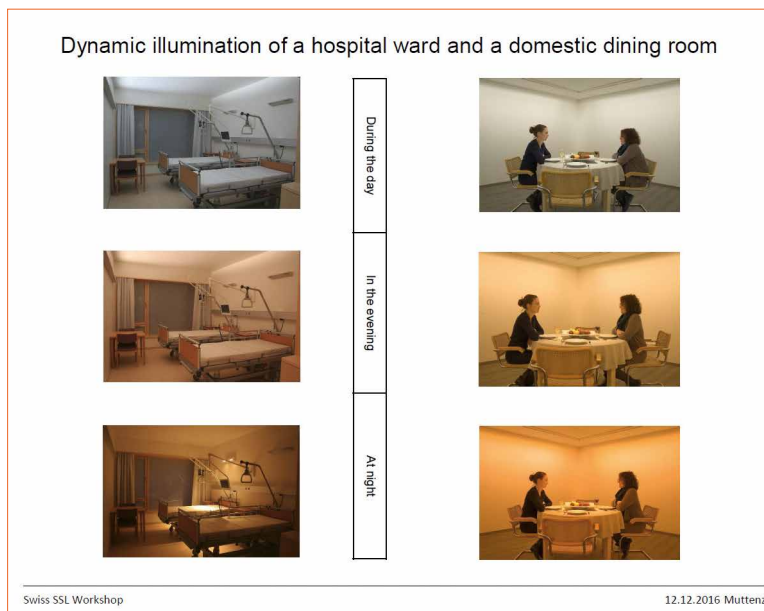

solutions should be dynamic and individual; dynamic in respect to intensity and duration, spectral composition, and dynamic according the time of the day; individual depending on gender, age and chronotype.

Wilfried Pohl from Bartenbach reflected on the topic from the

perspective of a lighting design company. He added technical questions and requirements to the medical requirements, and he showed a dynamic illumination of a hospital from a current research project. He identified some limitations and practical issues for successful implementation of dynamic and truly human centric lighting. The most

important ones on a long list are costs, complexity, confusing user interface, limited interoperability.

Dr. Heinz Seyringer from the Zumtobel Group added the view of a lighting manufacturer to complete the picture. He started by showing the dynamism of daylight during the day in respect to CCT and intensity. He showed what is already available on the market and some effects of human centric lighting on learning efficiency. He also emphasized that more than 95% of our decisions are made unconsciously and can be affected by light. He suggested that a more holistic approach might be taken into account, including non-visible light to HCL, like UV-B that triggers vitamin D production. Finally, he presented the company's thoughts about a more user-centric lighting achieved by intelligent, connected lights utilizing IoT and adding additional human centric services.

### Final Thoughts

This small but excellent event was well organized. It targeted technicians, R & D departments, SMEs and LMEs as well as lighting designers, architects, and end-users like large retailers. The aim was to bring together these different groups and to present the final results from the LASSIE project and related topics. The well selected topics and speakers in conjunction with the welcome networking opportunities guaranteed that the event fully accomplished its purpose. In short, MuttENZ was worth the journey. We are eager to see what is on the schedule for next year. ■



Smartify your lighting with Infineon's XDP™ XPDL8220 digital flyback controller

[www.infineon.com/xdpl8220](http://www.infineon.com/xdpl8220)





**MEGAMAN®**

# TECOH®

High Performance LED  
Light Engines and Modules



**eltefa** 

29 – 31 March 2017 | Messe Stuttgart  
Visit us at Hall 7, Stand 7A32

[www.megamantecoh.com](http://www.megamantecoh.com)  
[info@megamanlighting.com](mailto:info@megamanlighting.com)

# Thermal Management of an LED Light Source for Microscopes

Thermal management is a challenge for every LED and LASER solution. Microscope lighting solutions have some very critical requirements, especially if they concern medical applications. ESCATEC in Heerbrugg, Switzerland has a lot of experience in that field and covers all relevant technical disciplines. Wolfgang Plank, head of the MOEMS Future Laboratory and cleanroom, and Gerd Harder, Key Account Manager, give insights on the design process, thermal simulation and production of an LED light source for Leica Microsystems' Ophthalmic Microscope Proveo 8.

Leica Microsystems develops and manufactures microscopes and scientific instruments for the analysis of microstructures and nanostructures, and is one of the market leaders in microscopy. They are, for instance, renowned for their compound and stereo-microscopes. While being widely recognized for optical precision and innovative technology, they had a major issue with their newly developed light source for the Ophthalmic Microscope.

## About Ophthalmic Microscopy

A stable red reflex is one of the most important features of an ophthalmic surgical microscope for cataract surgery. It's the red reflex that makes the structure of the lens visible and thus makes for an uncompromised view for successful and secure surgery. However, conventional red reflex illumination often decreases during the critical phases of the procedure, such as during phacoemulsification. A new illumination technology based on a high efficient LED Module with four

individual beam paths overcomes these drawbacks. This ophthalmic microscope is the first system to feature the new technology. The CoAx4 Illumination provides a stable and consistent red reflex throughout the entire surgical procedure. Both main surgeon and assistant share the same view and full red reflex.

In the initial phase the thermal conditions and the light intensity output in full operation did not meet the specifications of the developers. Through the use of this customized high resolution thermal simulation tool,

**Figures 1a&b:**  
The ophthalmic microscope (left), and the TTL projected light beam of an ophthalmic microscope (right)



which was developed at the Institute of Sensor and Actuator Systems of the Vienna University of Technology [1, 2], a promising solution was quickly found. Functional samples were developed; light values were measured, discussed and further optimized. In the course of the optimization, the back-end cooling system with passive heat pipes was also conceived and produced.

### About the Thermal Simulation Tool

The simulation tool can solve the stationary and dynamic heat equation. The finite difference method is used as a solution method. At the beginning of the numerical calculation is a choice of the grid and the spatial discretization of the thermal model. Thereupon, the establishment of approximation equations for the spatial calculation area takes place with consideration of the boundary conditions. In the case of transient calculations, initial conditions are taken into account and approximation equations are set up for each time step (temporal discretization). Through this spatial and temporal discretization, the heat conduction equation in differential form is transformed into an algebraic equation system and this is solved with iterative methods.

### Heat equation

The heat equation is the basic partial differential equation for describing the temperature field in a stationary medium:

$$\rho \cdot c(T) \frac{\partial T}{\partial t} = \vec{\nabla} \cdot (\lambda(T) \vec{\nabla} T) + p_i \quad (1)$$

With the temperature  $T$  in K of the time  $t$  in s the density  $\rho$  in  $\text{kg/m}^3$ , the specific heat capacity  $c$  in  $\text{J/kgK}$ , the specific thermal conductivity  $\lambda$  in  $\text{W/mK}$  and the released internal Heat  $p_i$  in  $\text{W/m}^3$ .

### Finite difference method

By the discretization an orthogonal grid is placed over the model space. In a three-dimensional case, each

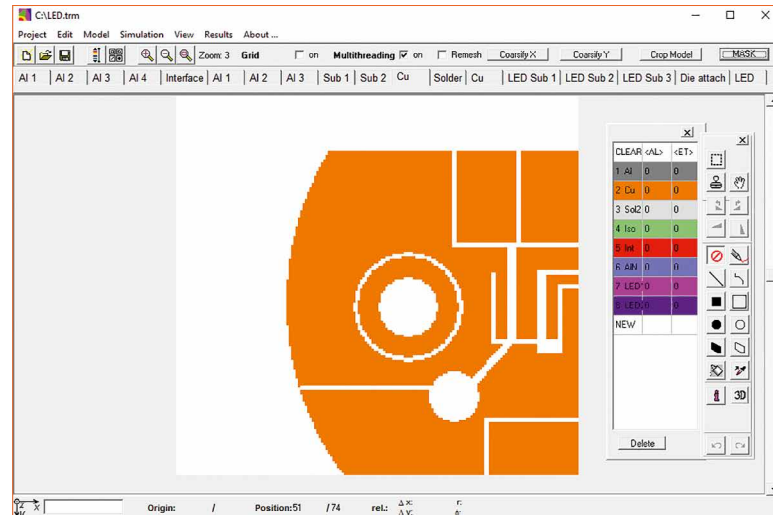

**Figure 2:** Main window with a model layer each color of the drawn geometry corresponds to a material

node has a maximum of six neighbors. If the general case the distances between the grid points along the coordinate axes are arbitrarily selected, this is referred to as a non-uniform grid. The finite difference method is based on the differential form of conservation equations. The differential equations are approximated at each node by replacing the partial derivatives with the difference quotients between the function values at the node points.

### Efficient Model Generation

One of the most striking advantages of this simulation tool is the possibility to generate models that are realistic, often built up of complex structures, quickly and flexibly. For discretization, an orthogonal grid is used, which can also be non-equidistant. This divides the model space into cubical volume elements whose size can be adapted to the desired accuracy. A material can be assigned to each of these volume elements, which is represented by a color in the model representation.

The geometry of the tasks occurring in electronics can usually be divided into planar layers. An example of this would be a multilayer circuit board in which insulation layers and copper layers (with the respective conductor pattern) alternate. A complex geometry is usually only present in the lateral extent of these layers. This situation is exploited during model generation. The model space

is subdivided into layers of different thickness and each of these layers is filled with colors by means of drawing commands, as known from pixel-oriented drawing programs, whereby the respective material data sets are assigned. Each pixel corresponds to a volume element, the temperature of which is determined by the equation solver (hereinafter referred to as solver). The structures of the individual layers can be taken over from existing drawings, which can be loaded as overlays. In this way complex geometries can also be reproduced very quickly (Figure 2). From the solver, the individual layers are then combined into a real three-dimensional model.

### Nonlinear solver

The solver used also works with non-linear system of equations, i.e. all material parameters, internal heat and boundary conditions can be taken into account as temperature-dependent variables. In addition, it is possible to specify anisotropic thermal conductivities (e.g. composite materials such as FR4: in the glass fiber direction higher thermal conductivity than perpendicular thereto). The temperature-dependent thermal conductivity is either entered as a polynomial or as a table. Figure 3 shows the input window for determining the temperature-dependent thermal conductivity.

**Figure 3:** Representation of anisotropic non-linear thermal conductivity in the simulation

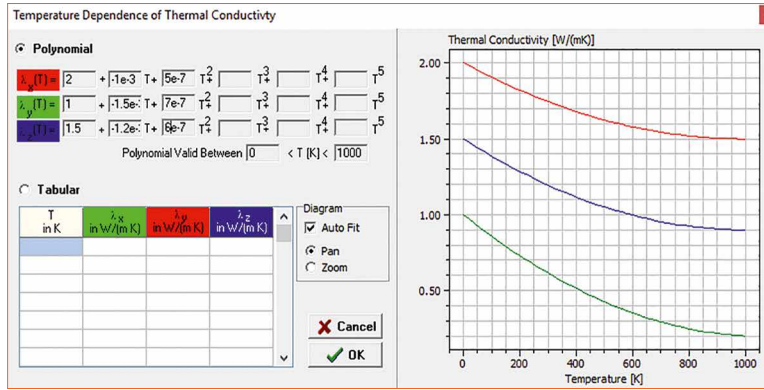

**Stationary & dynamic solver**

The simulation tool allows both stationary and dynamic problems to be solved. In addition to the temperature dependence of the material parameters and internal heat, dynamic dependencies can also be considered. The solvers used allow the solving of equation systems with several 106 unknowns.

**Stationary solver**

From the general heat equation from Eq (1) is obtained for the case

$$\frac{\partial T}{\partial t} = 0$$

The stationary heat equation:

$$0 = \vec{\nabla} \cdot (\lambda(T) \vec{\nabla} T) + p_i$$

The solution of the nonlinear heat equation is achieved in two steps: First, the system of equations is iteratively linearized using the following method: Considering an expression of the form  $aT$  with  $a = a(T)$  (a is a constant), a non-linearity of the form is produced.

$$aT = a T_i T_i$$

In the iterative method, the past value (time or iterative) is improved by new solutions until the following convergence criterion:

$$aT = a T_i^{n+1} T_i^{n+1} \approx a T_i^n T_i^{n+1}$$

Where  $n$  denotes the iteration index. In a second step, the linearized equation system is solved using the iterative SOR method (Successive Over Relaxation).

**Dynamic solver**

An ADI method (Alternating Direction Implicit) is used to solve the transient heat equation. On the one hand ADI methods can be understood as an iterative method for solving systems of stationary equations. On the other hand, they can be considered as independent method for solving unfixed problems. The main advantage of the ADI methods is the fact that only computation of comparatively small tridiagonal matrices is required, which is numerically favorable.

The class of ADI methods includes a variety of schemes which differ from one another in terms of consistency, stability and convergence. The used Douglas Rachford method is an optimized variant of fully implicit methods and has an accuracy of first order in terms of time. Numerous numerical methods are fast but show strong dependence of the convergence behavior on the selected numerical values and the number of equations of the system

(model complexity). The advantage of the modified Douglas Rachford method is the unconditional stability at optimized convergence speed.

**Boundary conditions**

The flexible and correct choice of the boundary conditions is of great importance for the simulation. A boundary condition for all cells on the model surface needs to be assigned. The simulation allows the definition of a specific boundary condition for each direction of a cell wall (whether a cell wall belongs to the model surface and thus the defined boundary condition must be taken into account in the calculation). Direct input of the following user-definable boundary conditions is possible: constant temperature (Dirichlet boundary condition), constant heat flow (Neumann boundary condition) and heat transfer by radiation and natural convection by input of a temperature-dependent heat transfer coefficient and the input of a material-specific, wavelength-independent emissivity of the surfaces. In addition to the user-defined input of the generally temperature-dependent boundary conditions, it is also possible to use heat radiation and free convection as a program-defined boundary condition. The temperature-dependent heat transfer coefficients of the free convection are then determined taking into account the model geometry of the program itself.

**Figure 4:** Representation of anisotropic non-linear thermal conductivity in the simulation

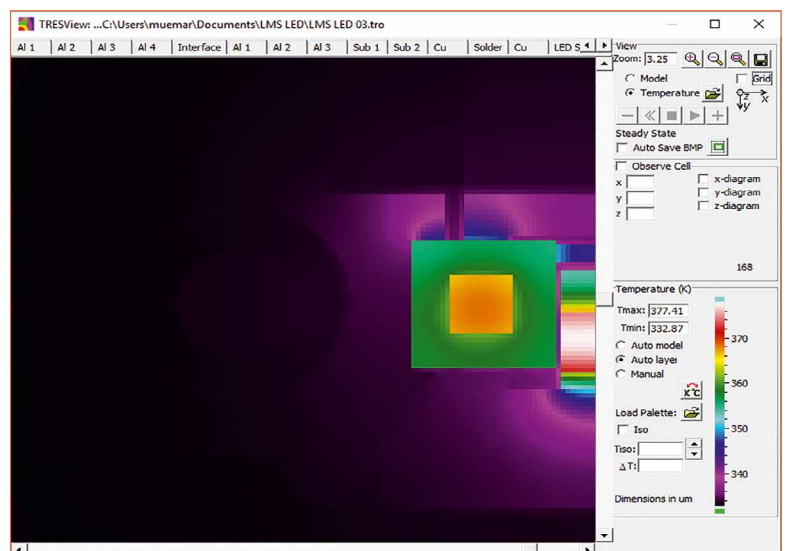

## Output module

The simulation results are evaluated in an output module in which the temperature distribution within a model plane is shown in an individually selectable false color display. Figure 4 shows this output module.

In addition, it is possible to output temperature profiles in x, y and z directions in diagram form. Figure 5 shows such a temperature profile.

## Production and Conclusions

On a copper IMS (Insulated Metal Substrate) with a thermal conductivity of 7.5 W/mK, three high power LEDs are arranged very tightly (Figure 6). The spacing was determined by the optical beam path. The total electrical power of the LED module is 27 W. The hot spot is the middle LED, which was assembled in Chip on Board (COB) technology to meet the very narrow space requirement. Both outer LEDs are mounted with conventional Surface Mount Technology (SMT). The middle LED is operated with 8 W. This means about 6 W power loss must be dissipated thermally between the two hot LEDs. This could only be realized by means of suitable copper structures on the IMS that have been simulated and optimized. The IMS is soldered on the cooling block. This metal interconnection was important for the thermal management and to assure that no oxidation of the interface or change of the thermal resistance occurs over the lifetime. The IMS design performance proved to be so good that the light source can be operated with 125% power without the LEDs reaching the maximum permissible junction temperature. The heat is transported from the copper block via two heat pipes to the cooling fins (Figure 7). This evaporation and condensation process in the heat pipe works in the range of the velocity of sound. The heat pipes are soldered to the

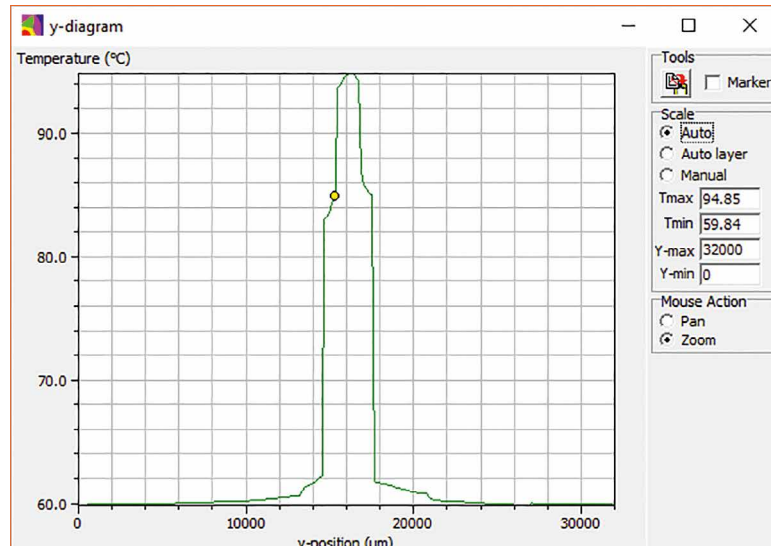

**Figure 5:**  
Illustration of a temperature profile

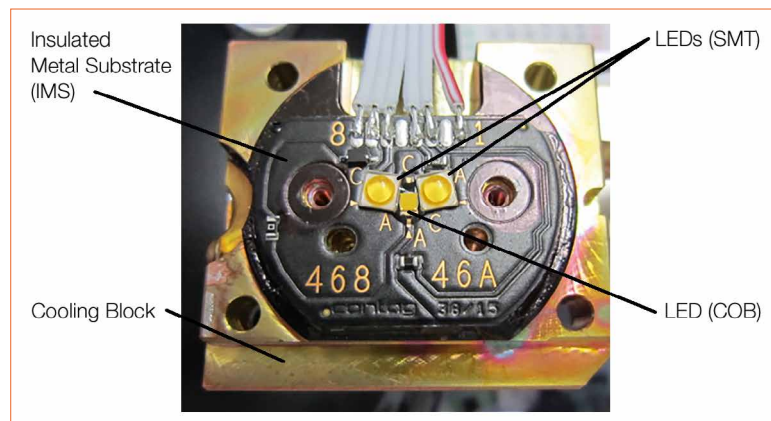

**Figure 6:**  
LED module soldered to cooling block

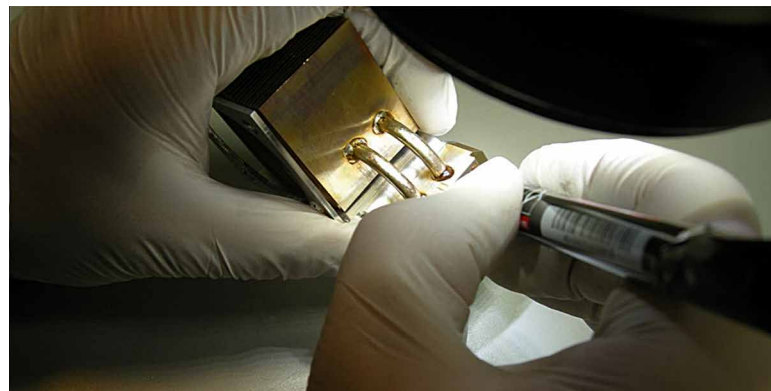

**Figure 7:**  
Assembly of heat pipes in the clean room

copper block to ensure consistent performance over the lifetime. A "Burn in" for all modules during which the thermal transitions are measured and documented before delivery ensures that all production units have the same quality.

With extraordinary good thermal management it is even possible to

drive LEDs harder than originally foreseen to satisfy the special demands of an application. Just innovative product design based on sophisticated simulation tools in combination with the correct material selection, excellent manufacturing methods and manufacturing capabilities lead to superior results. ■

## References:

- [1] Hanreich, G., Nicolics, J., Musiejovsky, L., "High resolution thermal simulation of electronic components," *Microelectronics Reliability*, Vol. 40 (2000), pp. 2069-2076.
- [2] Nicolics, J., "TRESKOM", White Paper, Institute of Sensor and Actuator Systems, Vienne University of Technology, 2008

# Enhancing the LED Experience - UI & UX as Success Factors for IoT Based Lighting Controls

As LED lighting systems become part of the Internet of Things, getting the interface right is essential if all of the potential benefits are to be realized. Karl Jónsson and Christian Moormann of Tridonic explain why UI and UX are crucial for the acceptance of the “Internet of Things”, give design hints and describe what this type of user interface that accommodates scalability, simplicity and ease of handling could look like. The authors also discuss examples based on a system Tridonic pre-launched in 2016.

Over the last decade or so, LED lighting has established itself as the technology of choice, compared to more traditional light sources, in most commercial projects, as well as many industrial and residential installations. In most cases, these decisions have been made on the basis of reducing energy consumption and running costs, against strict return on investment criteria - as well as delivering better lighting.

Now there is growing acknowledgment that the characteristics of an LED lighting system also provide the ideal basis for improving connectivity between many of the systems that keep our buildings working efficiently. As the Internet of Things becomes the “Internet of Light” it is essential that we understand the difference between user interaction design and user experience design.

At no point should we forget we are designing for people! It is therefore essential that all parties, from designers to end users, have a significant input to the final shape of the system.

Before discussing how this can be achieved, it's worth reviewing the key features that are driving this transition and putting SSL systems at the heart of enhanced interaction between buildings and their occupants.

**Figure 1:** The rapid expansion of the Internet of Things has the potential to make our lives much simpler including Apps to control a wide range of building functions that can be easily performed on a smartphone

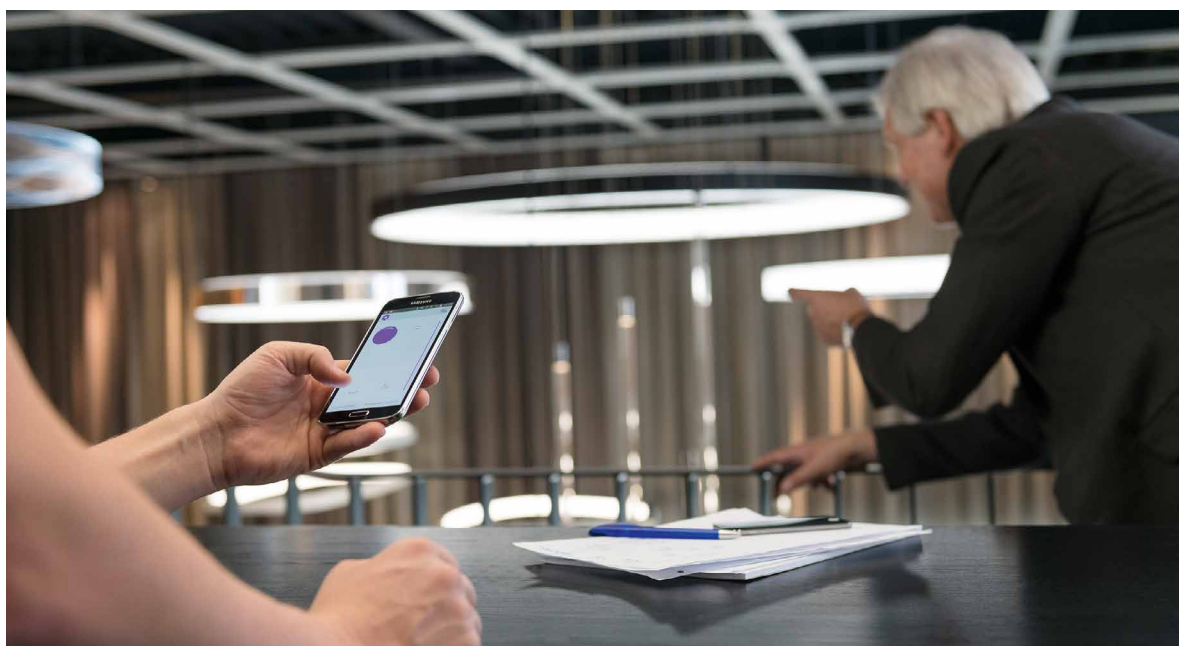

## LED Popularity

Since LED light sources were first introduced they have built up a well-deserved reputation for providing significantly better energy efficiency than traditional light sources such as incandescent, fluorescent and high intensity discharge. This has clear benefits in terms of reduced energy costs and environmental impact.

A further benefit is that they last much longer than these traditional light sources, so that the costs and disruption associated with maintenance are greatly alleviated.

## Low Voltage, Low Power

Moreover, an LED lighting installation is effectively a low voltage, low power environment, compared to traditional light sources that required hundreds of volts and a significant power supply. As a result, the Ethernet cables in the building can also be used to carry the power supply for the luminaires, alongside the data required for controlling and monitoring the lighting (PoE, Power over Ethernet). PoE cabling also enables faster data transfer compared to traditional twisted pair control cables.

This delivers significant benefits to building operators, as there is no longer any need for separate power cabling to the light fittings - so that material costs and installation time are both reduced. It also makes any retrofit or future re-configuration far more straightforward, enabling the building to be optimized through "continuous commissioning" as the building's usage evolves.

## The Internet of Light

Given all the benefits of LED lighting, its potential for playing a decisive role in the Internet of Things is obvious. In 2015 around five billion smartphones, tablets, smart electricity meters, cars, factory machines and other devices were communicating via the Internet. It has been calculated that at some point during 2016 it will have risen to

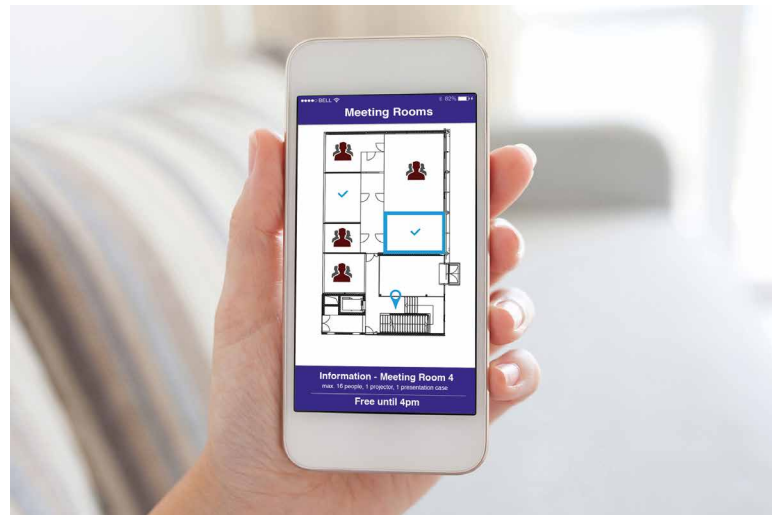

**Figure 2:** A single presence sensor situated discreetly in a luminaire is sufficient for detecting whether an office is occupied or not and can be controlled via a smartphone App. The data is then stored on the 'cloud' and forwarded to the various systems including HVAC, window blinds, security management and lighting control

between 7 billion and 8 billion. Potentially, this will exceed the number of the people on the planet! This rapid expansion of the Internet of Things is a direct result of the boom in applications that add value for end users. The sheer diversity of functions that can be performed on a smartphone is augmented by enhanced, internet-based communication by domestic appliances, vehicles, electricity meters and robots in factories.

The trouble is, such a vast quantity of interconnected devices also brings increased complexity. Just look around any modern office building and you will probably see an array of different occupancy sensors, from different manufacturers, doing slightly different things and all communicating their data back to different systems. One may be controlling the lighting, another the security system with perhaps a third and fourth controlling the air conditioning and blinds respectively. Yet the Internet of Things has the potential to make our lives simpler - as well as richer. Increasing the richness of our existence is of little use if it brings the headaches associated with complex systems.

So what is needed is greater simplicity with harmonization of the various devices involved. To do that, we need a common infrastructure into which the Internet of Things can be simply "docked". In this respect, the one thing that just about every building already has is a lighting

system with an integrated power supply. In many of these light fittings there is plenty of room to introduce one or more digital sensors or microchips - after all, digital electronics is already at the heart of LED lighting. Furthermore, most luminaires are installed on ceilings or walls, the ideal positions for sensors - which can communicate using the wireless or data cabling already being used to monitor and control the lighting. This arrangement enables the simplification of data collection in the various spaces. Instead of having an array of different occupancy sensors for various functions, a single sensor can provide occupancy data to each system. The data is the same; it's the way it is analyzed that differs.

For example, a single presence sensor integrated out of sight in a luminaire is sufficient for detecting whether an office is occupied or not. This data is then stored in the "Cloud" (i.e. on an Internet or intranet server), evaluated and forwarded to the HVAC systems, window blinds, security management system and of course to the lighting control system. This occupancy information can also be used to provide information about how various spaces (offices, meeting rooms etc.) are being used. Armed with this data, facilities managers are able to optimize the space in their buildings, potentially freeing up under-used space for sub-letting. Traditionally, such space utilization areas have

involved walking around the building with a clipboard and noting which workstations are in use. Not only was this incredibly time- and resource-intensive, but by the time the data was analyzed it was also already out of date.

Nor is this functionality confined to indoors. Presence sensors in car park lights or street lights can indicate where there is a free parking space, pass this information on to a satellite navigation system and ensure that the free space is indicated by some visual means, such as a green light.

Indoor navigation will also be possible by using “beacons”, small Bluetooth transmitters, in the luminaires. With the aid of these radio transmitters anyone with an appropriate smartphone app will be able to pinpoint their location to within a few meters. This will be invaluable in helping people find their way around large buildings such as shopping centers, hospitals and airports - as well as for finding a particular product in a large store.

Unlike with previous systems the beacons would no longer have to be installed separately or set up individually because of a lack of a network, and the need to regularly replace batteries would no longer be an issue.

### The Right UI for the Right UX

As noted at the beginning of this article, when implementing such systems, the needs and experience of the people using them need to be first and foremost. To that end, it's important to be aware of the difference between interaction design and user experience design. The former - the user interface (UI) - focuses on making the interaction between people and technology user friendly. The latter - the user experience (UX) - makes sure the entire process is a pleasant experience. For instance, it may be possible to develop a product that is incredibly intuitive and user-friendly - but how does the user experience it?

If it doesn't excite or inspire, i.e. it's boring, it will not be a compelling experience and people will not be motivated to use the product.

Thus, the UI and the UX need to work in harmony - that's why product and interface development is ideally a team effort between engineers and designers. Moreover, any software that is going to operate within an Internet of Things (IoT) environment needs to keep pace with rapid changes in direction. To that end, developers such as ourselves, have moved away from the traditional “waterfall” method of software development to an “Agile Scrum” approach. This approach allows dynamic changes and accommodation of fast-evolving feature sets and customer inputs, thereby ensuring the software is constantly tested and challenged - in terms of functionality, UI and UX - as it develops. Thus, the software test becomes an integral part of the development process and the results can be checked against expectations, enabling re-prioritization, if necessary.

This principle applies just as much to professional, business-to-business scenarios as it does to the consumer world. Tools that facilitate the workflow of a professional need to do more than just make the task easier. Lighting designers, commissioning engineers, installers, etc. are proud of their job and their expertise. By providing the tools that help them excel at what they do (design tools, commissioning tools)

those tools become an integral part of what makes their job a gratifying experience.

For instance, a traditional UX for professional software tools required considerable technical training and field expertise. Enhancing the UX and taking advantage of the latest mobile platforms makes the whole process quicker and easier, so that staff productivity increases and the commissioning process is faster with a significantly reduced risk of errors.

Interestingly, the consumer world is setting the benchmarks for UX design these days. When it comes to innovations in terms of software/app design, VR applications, Internet of Things, online services and new business models (amongst others) the paradigm shifts are driven by consumer propositions. This is mostly due to the incredibly short innovation cycles in those markets and this is an area where professional industries need to catch up. People's expectations of what technology can do, and how they can interact with it, are strongly influenced by the products they use in their private lives.

In the area of lighting this is being addressed by bringing together electronics, sensor technology, software and LED luminaire control to develop future-proof hardware and software platforms. Such a toolbox comprises LED drivers, communication modules, sensors,

**Figure 3:** Occupancy information is vital in the event of fire evacuation and a smartphone App makes this possible. Indoor navigation is also possible by using ‘beacons’, small Bluetooth transmitters in the luminaires. Anyone with an appropriate smartphone App will be able to pinpoint their location and identify fire exits easily

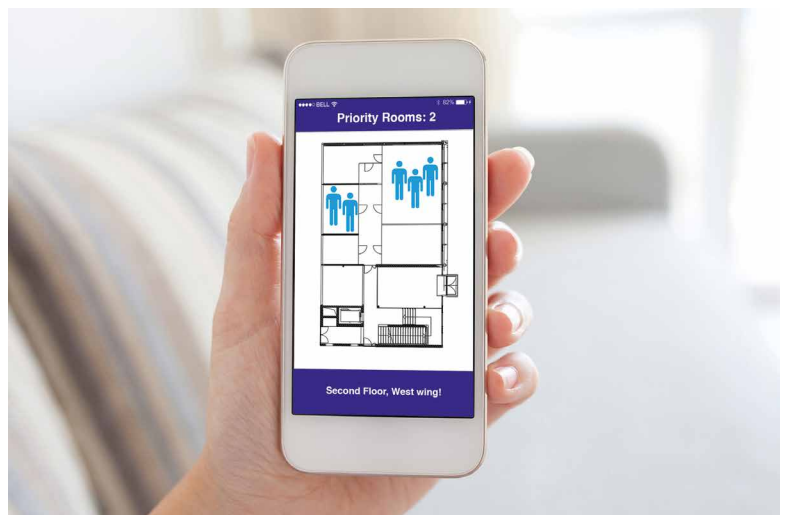



routers, software and applications. In this way, the UX design of professional software tools is blended with the common UX principles of consumer products, making the complexity vanish for the user without hiding the capabilities and details that deliver the required functionality.

For these reasons, in developing such a system, Tridonic employed a UX/UI designer with experience in cutting-edge UXs for consumer apps - an environment where user manuals are not an option. This was combined with a prototype/emulation tools called Invision that enables collaboration and real-time testing of concepts, features and user requests with product management and user groups before work began on writing the code. Such an approach allows rapid iteration of the UI and UX based on real-time feedback. Just as importantly, industry professionals were interviewed and observed to get feedback on daily workflow of existing solutions. This formed the basis for determining how their tasks could be simplified and accelerated effectively whilst ensuring reliability of installations and operations. Crucially, such systems need to be an open

platform, flexible and scalable to ensure they support interoperability and open hardware and software interfaces. For instance, software architecture based on the open standard of the IPv6 Internet Protocol enables wireless communication using a low-power version with IPv6. This operates like a low-energy version of WiFi with networking capability, whilst the application and communication layers also use the usual open standards.

Earlier this year the first such system that enables both wired and wireless communication, and is scalable for any size of building or area, was pre-launched under the name net4more.

A system designed in this way incorporates considerable future proofing, which is extremely important for areas of application that have to operate reliably for many years - for example in office buildings and factories. It also offers building operators the option of integrating their own solutions, whether hardware elements or apps for data analysis or control.

The development of such systems opens up the most direct,

most efficient path to the Internet of Light, all facilitated by the growth of LED lighting and the enhanced functionality that it brings. Future developments will focus strongly on the convergence of new technologies and smaller communication modules and sensors, along with new LED luminaires, apps and mobile Internet. All of which will reduce complexity and costs for building owners and operators whilst enabling them to provide additional services through the Internet of Things/Light.

### Summary

LED lighting has the potential to deliver major benefits in terms of lighting performance, energy efficiency and cost of ownership. Making the most of this potential necessitates effective control, through control systems that are not just easy to use, but also a pleasure to use. In this way, end users are encouraged to take advantage of all of the functionality available, resulting in a dynamic and responsive lighting system that meets the needs of all stakeholders. ■



fresnel, diffractive, lenses, dif-  
fuse, silicone, individual, as-  
pheric, cylindrical, prototypes,  
led-optics, stainless, arrays,  
spheric, plastic optics, design,  
production & development



[www.imos-gubela.com](http://www.imos-gubela.com)



**STANDARD** and **CUSTOM OPTICS** for you!

**Get in contact!** [info@imos-gubela.de](mailto:info@imos-gubela.de) / +49 (0) 7843 99511-0

IMOS Gubela GmbH • Kniebisstraße 1 • DE-77871 Renchen

# Technical Aspects Regarding the Equipment of Show Caves with Modern LED Systems

Caves have an almost magical attraction over people, drawing them again and again into their depths. The first electrification started in the 19<sup>th</sup> century, culminating in today's digitalization and "LEDification". Vladimir Vashkevich, Technical Manager at Cave Lighting CL GmbH & Co KG, describes the tough requirements on luminaires and the whole installation. He explains the advantages for the operators and the ecosystem and finally discusses solutions, practical examples and future prospects.

Man has always been fascinated by the subterranean world with its unusual and mysterious beauty. Show caves play an important role in the tourism

of many regions, giving people the chance to discover hidden secrets. Since the first artificial light installations were initiated in the late 19<sup>th</sup> century, show

cave illumination has undergone several stages of modification. At present, the introduction of LED lighting with its digital technology is in full swing.

Caves have always fascinated people. They have been used for shelter, ritual ceremonies and spiritual events. With electrification they have also become tourist attractions. Depending on the hue intensity or direction of the light, the caves change their appearance in an almost mystic way

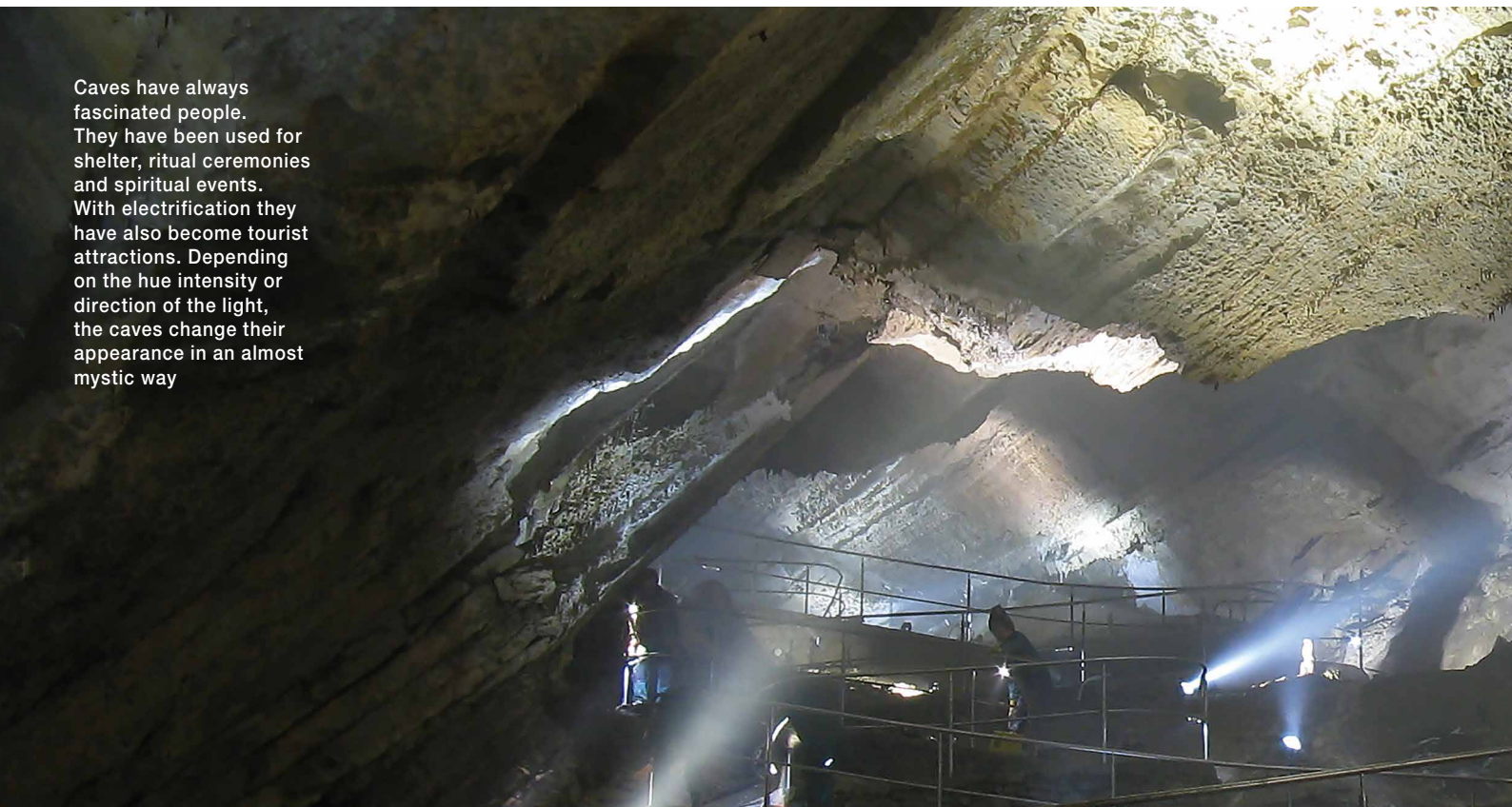

### Specific Features of Show Caves

The main task of a lighting system in a show cave is primarily to ensure the safety of the visitors as well as providing maximum aesthetic effects. The lamps themselves must be suitable for the harsh, damp environment. It should have only the most minimal negative ecological impact and be so installed that it is practically invisible.

Above all, the growth of so-called lamp flora and the effect on temperature in a closed ecological sphere must be combatted. Natural caves are first and foremost - dark! Artificial light induces the growth of algae, bacteria and plants which often form a carpet of green otherwise not found in a cave. An excessive increase in air temperature caused by the lighting is a destabilizing factor that has a negative effect on the subterranean ecology. A person's presence alone warms the surrounding air as would

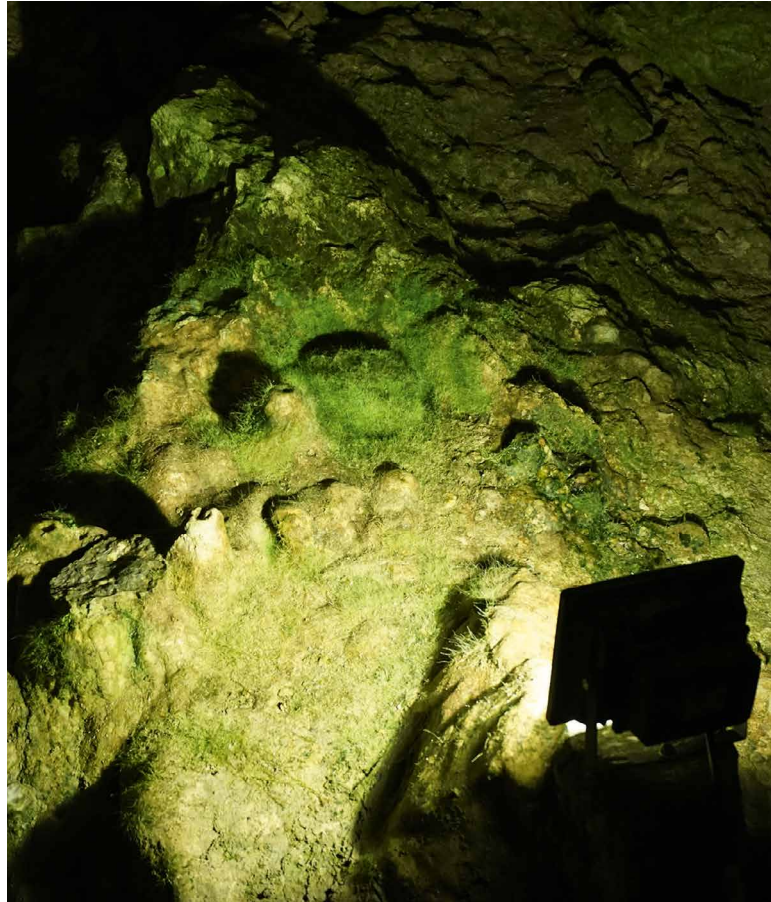

Poor and inadequate light can cause irreversible damage to the sensitive ecosystem in caves. Algae and mosses can grow instead of geological structures like stalactites and stalagmites



a 200 watt heater. The carbon dioxide in expelled breath and any contamination on shoes and clothing are further undesirable factors. Adverse influence on the ecological system should be kept as low as possible. This is one of the greatest challenges when installing a lighting system in a show cave.

Much has been said and written about the advantages of LED lighting. Probably everyone knows its characteristics: reliability, energy efficiency, simple operation, etc. However, its use in show caves provides not only improved visual perception but also meets the rising demands of environmental protection.

At present there are hardly any special solutions for the use of LEDs in show caves. The standards for above ground installation are often just adapted for subterranean application. However, not all such adaptations are successful. In many cases equipment that performs excellently when used in the open often fails after a short period under ground. A good, functioning lighting system for show caves not only

depends on an extensive knowledge of lighting technology but also on considerable understanding of subterranean conditions. Developers of LED systems are usually unfamiliar with such an environment, which requires speleological knowledge. The experience of speleologists enables them to develop successful technical solutions and LED systems for underground projects.

### Lighting Up Caves

During the last few decades show cave visitors have become accustomed to viewing the Earth's interior in conventional warm light with a high degree of brightness. However, the introduction of LEDs and the advent of their integration in subterranean illumination systems have changed the approach and ensuing methods dramatically.

Using LED technology the intensity of the light is greatly reduced. Not only for environmental reasons, but also to achieve three-dimensional perception for the visitor. Lighting used at home or in the office that is considered dim is quite adequate

for show caves where light and shadow are united to form a three dimensional image when illuminating stalactites, stalagmites and other formations. Moreover, the mystical ambience allows the visitor to experience the underground world like an explorer.

The color temperature of the employed LEDs was changed from 3000 K to colder temperatures. The use of cold (6000 K) and neutral (5000 K) LEDs alters the appearance of a show cave considerably. Daylight lends a unique individuality to formations and wall structure. The combination of small lamps at different angles for accent lighting intensifies the impression of depth.

An important factor when installing lighting systems in a show cave is avoiding any blinding effects on the visitor. The adaptability of the human eye is limited, so special methods to prevent dazzling must be employed: lamp shades, visors, avoidance of direct illumination, the use of scattered light and concealment of the lamps.

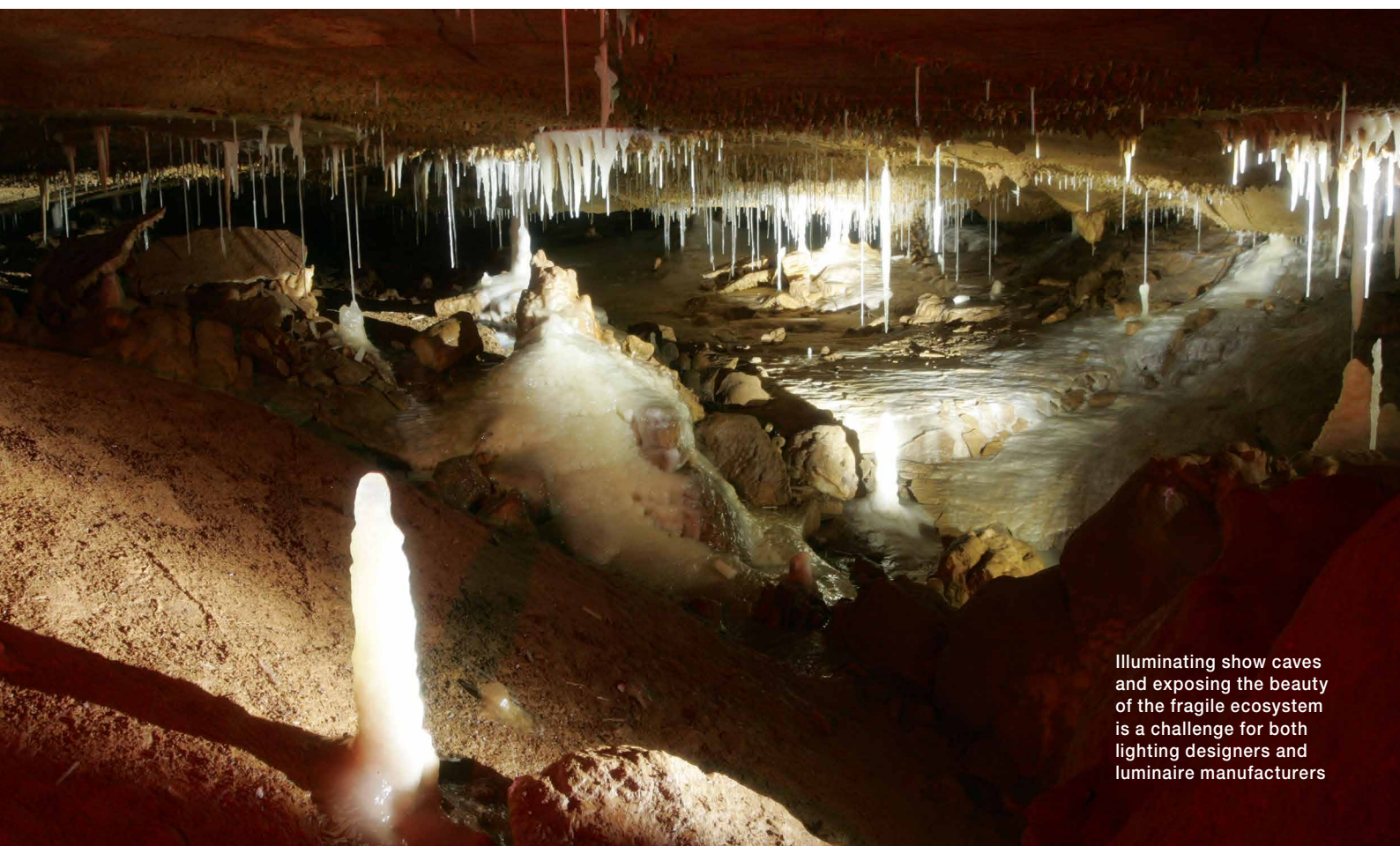

illuminating show caves and exposing the beauty of the fragile ecosystem is a challenge for both lighting designers and luminaire manufacturers

It should be mentioned that conventional, though modern, techniques for desktop designing of lighting systems for subterranean objects are not always suitable. For example, it is almost impossible to create a model for adequate illumination using a lighting simulation program and to then carry out the concept. The interior of underground cavities is so heterogeneous and unpredictable that it is more practical to implement a lighting concept whilst actually carrying out the installation relying on personal experience.

### Protecting the Equipment from External Factors

The most difficult factors to be taken into account during underground installation are 100% humidity, drip water and aggressive alkaline surroundings. These present special demands on the construction and application of lighting technology.

#### These demands entail:

- Protecting all electrical connections using suitable sealing compounds
- Protecting electronic components using water resistant varnishes and coatings such as Parylene
- Ensuring that no water is able to penetrate lamps and control units when laying and connecting cables
- Minimizing the number of electrical connections
- Taking care that the ends of still to be connected cables do not remain exposed for a longer period
- Filling the interiors of lamps with silicon or polyurethane foam if necessary
- Protecting the climatic condition in electrical cabinets
- Using only corrosion-free materials e.g. stainless steel

Only the complete sealing of all components ensures total protection against the effects of water. Based on long term examination and testing in electrical

**High humidity levels and alkaline elements quickly corrode lamps that are not protected properly (top). To avoid these types of problems, everything must be sealed accordingly when connecting them (center and bottom)**

installations a 2-component sealant such as Tyco Gurosil Gel is recommended.

One of the most important parameters for the operation of LED lamps is the surrounding temperature. For application in a cave this is no critical issue because cave temperatures are almost always stable and usually quite low, seldom exceeding 20°C. There is also no influence by ultraviolet radiation, which is characteristic when used above ground to illuminate architecture. The same applies for wind and snow load.

### The System

The basic lighting system in a show cave mostly incorporates the following systems: main- and emergency lighting; central and local controlling; electricity supply and multimedia system (with static or dynamic light scenes).

According to experience in the installation of lighting systems it can be said that there are two approaches to the layout of such a system: standard and customized installation. The first comprises inexpensive and standardized solutions that do not take the conditions of use into account. That is, mostly cheap, normal outside lighting units are acquired by show cave operators, such as lamp brackets made of galvanized steel and ordinary outdoor cables, in the hope that the installation will run reliably for a long time. Sometimes such an approach works, even for a longer period of time. However, experience shows that the average faultless running time of such installations is only about one year. Therefore it is of the utmost importance when designing and installing lighting systems in a cave to direct one's attention to all technical details no matter how small and insignificant they may at first seem.

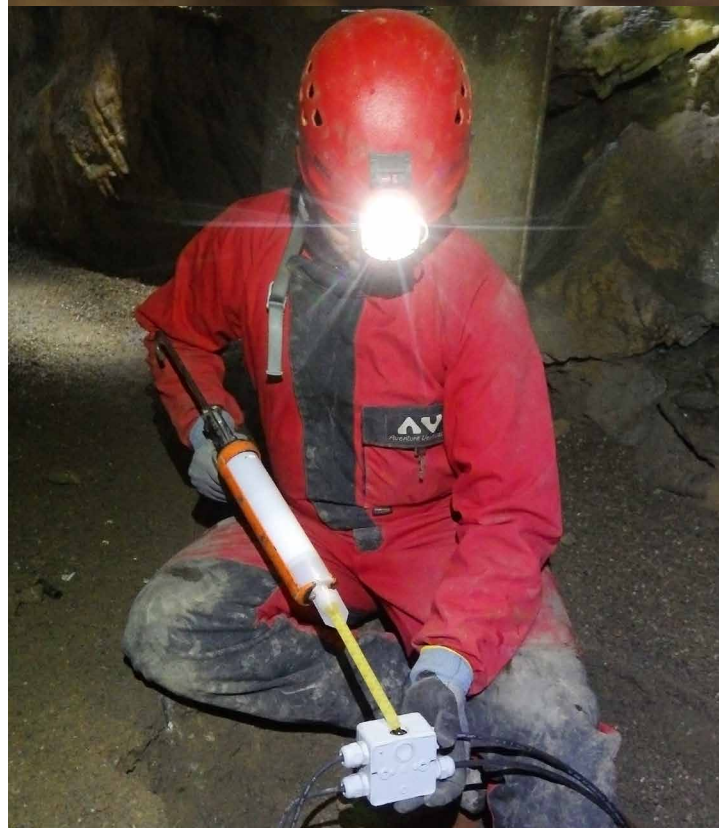

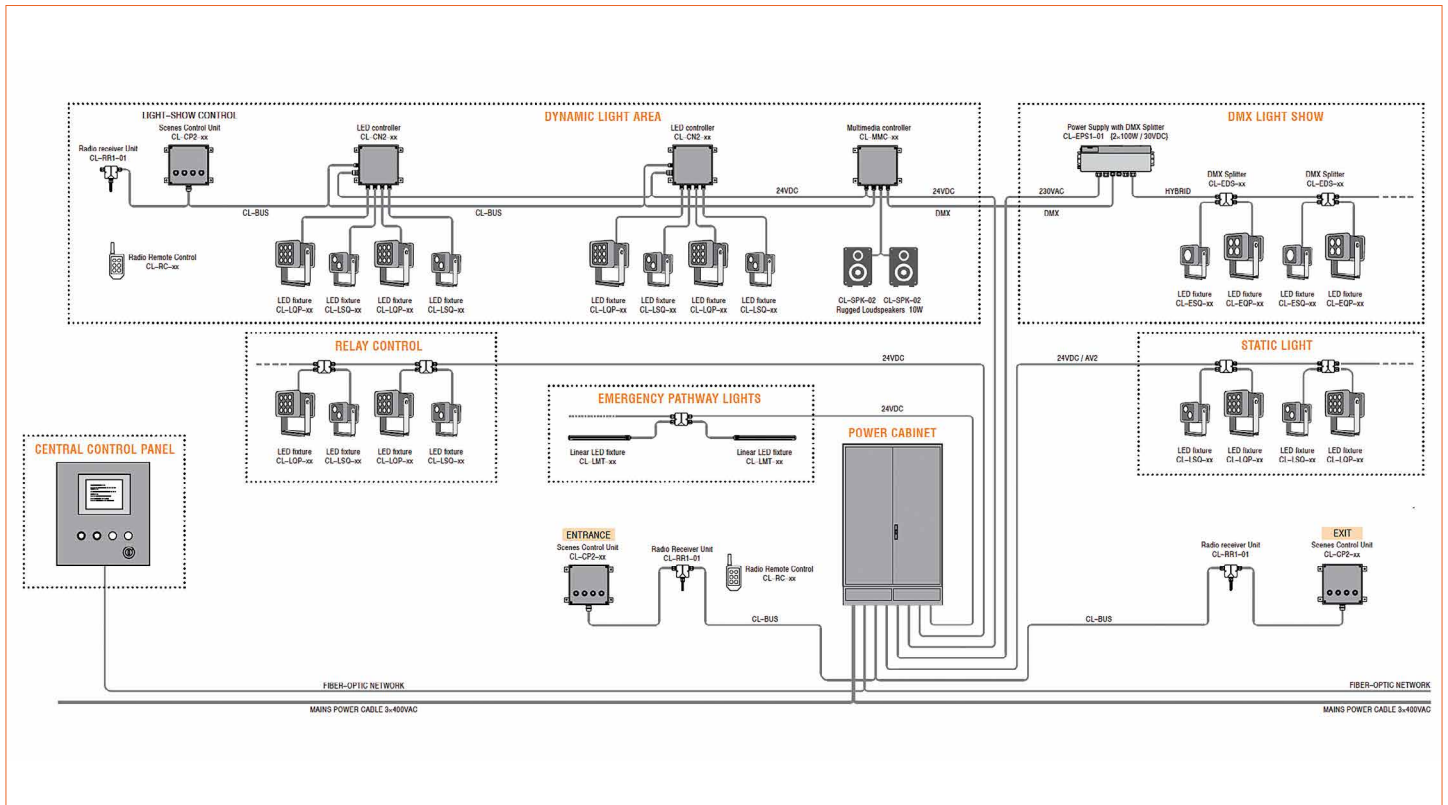

Modern cave lighting requires a complete system that satisfies different demands including emergency lights, static light, dynamic light and DMX for show lighting

## The Design of Lamps

As mentioned above, the brightness of the new lighting system should not be too high though the LED system must ensure safe and comfortable movement for the visitor. A great deal of light and wrong positioning of the lamps may dazzle the viewer and also lead to an impairment of the cave's ecology; e.g. the growth of lamp flora. Therefore, low power lamps of between 1- 17 W are admirably suited for use in underground chambers. The basic principle is: not too much light, correctly and controllably directed and adapted to suit the theme of the guided tour. Reducing the size of the lamps is useful when developing waterproof units with an IP code x8 and helps combat the "heat pump" effect when the LEDs rapidly cool down.

The most important constructional features of the lamps lie in the use of non-corroding materials. The front cover is made of a specially treated polycarbonate; the outer parts of the housing from high-alloyed stainless steel. The inner aluminum housing has an MDO surface and/or an epoxy

polyurethane coating, which is important for heat dissipation. Contact between the different materials is avoided completely in order to prevent galvanic corrosion of individual elements.

The unit is connected by the integrated cable. Inside, the screw connection is also sealed. The individual wire ends are protected by a further sealant filling in order to prevent water seeping in between the strands of the connection cable.

The integrated driver is only designed for low voltage: 24 V DC or 30 VDC. With the help of precisely chosen electronic components the lamps are protected from switching faults, overvoltage and overheating.

The lamp housing is categorically not meant to be dismantled or repaired on the spot. The units are manufactured and packed under exclusion of residual moisture. The waterproofing of the lamps is tested under a pressure of 3 bar. All lamps pass through an obligatory MTBF examination.

Technical data of different options:

- Electrical output: 3 W, 7 W, 12 W, 17 W (RGBW)
- Lumen: 240 lm, 500 lm, 1200 lm, 1200 lm (RGBW)
- Light options: Cold, neutral, and warm white, RGB, RGBW, CWA
- Beam angle: Narrow Spot (10°), Medium spot (20°), Wide spot (40°) Flood (70°, 120°)
- Supply voltage: 18 - 36 VDC
- Electrical connection: integrated cable
- IP code: IP68
- Control options: DMX / RDM, PWM

A wide range of settings and options allows the creation of a flexible and versatile system for show cave lighting.

## Lighting Controls

One of the great advantages of the LED lighting system is the relatively simple control of light scenes. The lighting should only be switched on when visitors are actually in the illuminated area, apart from when they are experiencing a light show. Otherwise it should remain off. The most effective method for protecting the cave's ecological system, for example, by combatting the growth



of lamp flora, does not lie in the use of chemical or bacteriological technologies but by reducing the periods of lighting to a minimum. The correct use of light control also intensifies the visitor's emotional perception.

As well as in physical control levels the show cave is also divided into logical control zones. During the tour the control of one area can be transferred to another and each zone may have its own control script. In general, the basic principle is: arrive - switch on - leave - switch off.

When designing the control system various options can be used, depending on the specific demands of a certain object: a simple relay control, brightness control, and dynamic lighting or static-dynamic show. By technical means any combination of these options can be used. The chosen control system is primarily dependent on the cave's characteristics and the concept of the guided tour. The guide can, for example, influence the lighting by remote control, or it may operate in stand-alone-mode, for example activated by motion sensors.

**Three fundamental elements of a cave lighting controls system:**

- Lamp control unit CL-CN2
- Light scene control unit CL-CP2
- Multimedia control unit

#### **The LED lamp control unit**

The LED lamp control unit supplies the power and controls the brightness and PWM regulation of the LEDs (dimming). The control unit receives commands from the Cave Lighting™ System interface and controls the connected lamps in regards to internal scenes and configuration. Several control units can be employed in one system and programmed accordingly. Stand-alone versions are also possible.

#### **The keypad / light scene control unit**

The keypad controller is responsible for the communication between the user and the lighting installation. With a keystroke the user can send commands to the control unit to change light scenes that are stored in an internal memory. The user can manually alter light scenes or scenarios by means of a local

keypad. The function of each key can be individually programmed.

#### **The multimedia control unit**

The multimedia control unit is an all rounder. The controller unites within DMX512, a player with recording function and an MP3 player. The control unit can actuate the DMX lamps directly via 8 channels. It takes over the task of controlling varying light and music shows, also the controlling of any number of DMX units connected to the system. The unit can be programmed with a notebook. The internal micro SD memory card stores audio and light show sequences.

The units are contained in a protective body made of compressed rubber and achieve protection level IP67. The electronic components of the units are coated with a special paint and protected against overvoltage and switching faults.

The control system also supports other auxiliary units such as DMX splitter, receivers, adaptors and other remote controls.

**The light scene control unit, CL-CP2, is one of three different control units. It can be used to accommodate different situations with various light scenes**

### The Trend to Smart Caves

The present trend, which includes show cave projects, lies in the introduction of smart solutions as in “smart homes” or IoT. Modern show caves are therefore equipped with complex systems on the basis of IP networks using optic fiber communication cables. These systems allow additional equipment to monitor the progress of the guided tour, the microclimate, etc.

The introduction of modern technology also influences the operating conditions in show caves. Today’s means of communication for “intelligent” solutions for wireless interfaces on 2.4 Ghz basis (WiFi, Bluetooth, ZigBee) do not always work well and can be unreliable. This is due to the diffusion characteristics of radio waves under ground. Communication usually only functions up to the first bend or other rocky obstruction. In order to ensure continuity additional cables and repeater have to be employed that have a negative influence on the general reliability of the system.

Industrial receivers with a frequency of 433 Mhz have proven to be reliable for local control of lighting zones but such receivers should be chosen carefully.

As already mentioned, a show cave is a complex object consisting of lighting and other related systems. An important element is the function of the central control and monitoring not only of the technical status (battery condition, backup, fuses, and emergency control). Constant surveillance of tour progress is also necessary in order to prevent possible conflict between separate groups. Monitoring of fluctuations in the microclimate, radon content of the air and water levels are just a few of the system’s further functions.

SPS controls computers are often installed to monitor things like air quality, micro-climate and surveillance of the tour progress

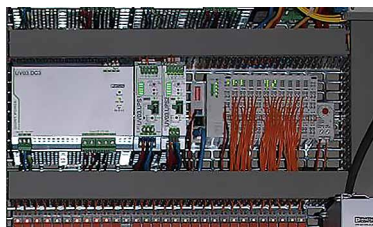

### A Cave Is Not Just a Cave Anymore

The modern digital world provides new solutions that no one would have thought of even just a few years ago. The world of show caves is becoming multimedia. To improve the aesthetic impression for the visitor, the lighting is supplemented with dynamically colored shows synchronized with sound and music, video mapping on walls and natural formations, the accompaniment of a multilingual audio guide, interactive media displays and 3D laser shows.

One of the latest trends in technical development is the creation of selfie points (Facebook points) - well lit locations where visitors can take photos and immediately post them to social networks.

When introducing new technology it is very important to maintain an appropriate balance between natural objects and the equipment that has been installed.

### Power supply

For safety reasons low voltage - 24 V or 30 V - as a main power supply is used for the lighting. In regards to this, certain characteristics must be given consideration. To avoid high power loss, thicker cables with larger diameter cores must be used. When planning the installation, the fact that the incorporated LED drivers serve as power stabilizers (constant current) must be taken into account so that the loss is not linearly dependent on the power. When calculating cable lengths there

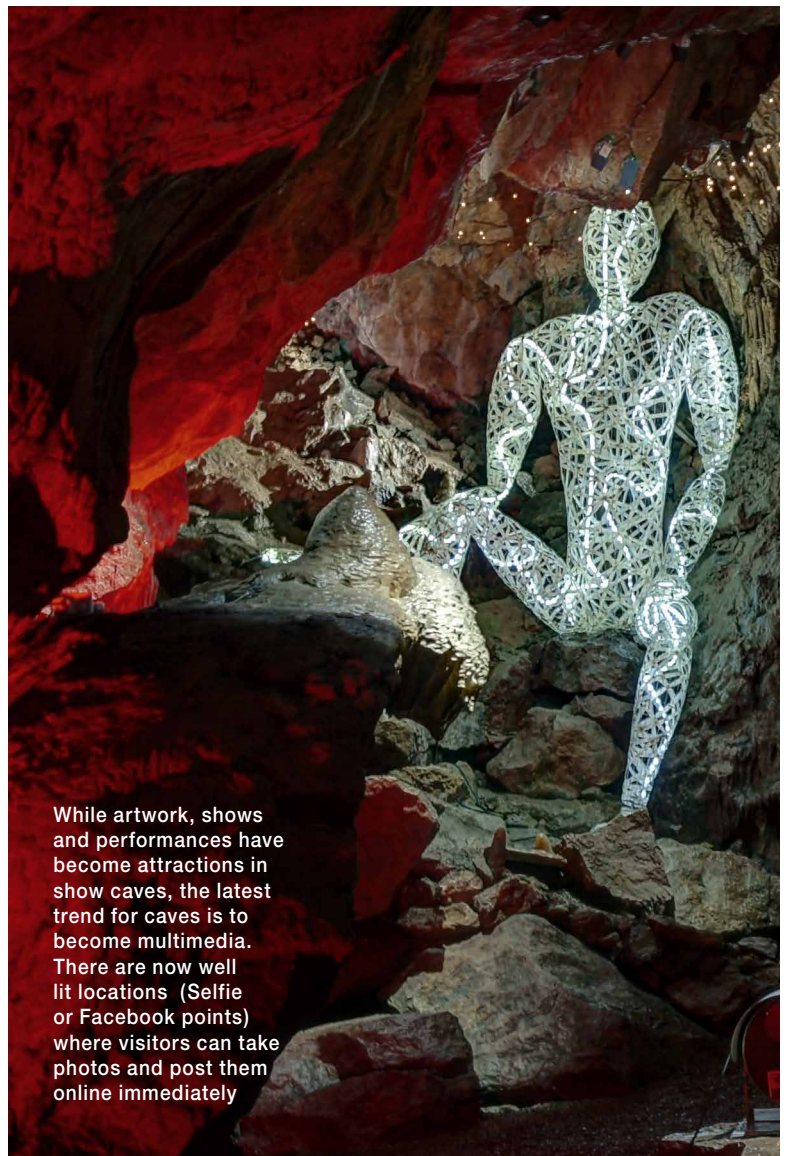

While artwork, shows and performances have become attractions in show caves, the latest trend for caves is to become multimedia. There are now well lit locations (Selfie or Facebook points) where visitors can take photos and post them online immediately





# LED Expo Taiwan

The 13th Int'l LED Exposition  
[www.optotaiwan.com](http://www.optotaiwan.com)

**June 14-16, 2017**

TWTC Nangang Exhibition Hall

## Featured Presentation: Automotive LED



### A The development of new LED business patterns

The new blue ocean market for LED: UV LED, IR LED, Proof lights, Automotive LED, jointly demonstrated in special zones



### B Total Solution @ One-stop shop in "Photonics Taiwan"

Cross-industry platform, promotion and integration of automotive Photonics, finding best partners in Taiwan



### C Most update market trends

International forums, new technical publications to disclose comprehensive market trends and new technologies

## Exhibits

### ■ LED / OLED Light Source, Package / Module/ Engine

LED Epi Wafer / Chip, OLED Components, LED Package, LED Module / Engine, OLED Module / Engine

### ■ LED / OLED Lighting Fixture

Technical Lighting  
Decorative Lighting  
Accessories and Electronic Components

### ■ LED Applications

Backlight, Automobile, Display Board  
Traffic Signal, Projector, IrDA, IR / UV Lights  
Others

### ■ LED / OLED Materials

LED Materials  
OLED Materials

### ■ LED / OLED Equipment

LED Equipment  
OLED Equipment



shouldn't be more than an estimated 10% loss of the total energy consumption.

### Safety

First and foremost the main operational plan for the lighting system must make provision for the safe evacuation of persons in the case of power failure. An emergency power supply must be in readiness in order to allow control of the path lighting system to ensure safe evacuation. The use of low voltage and low power LED lamps simplifies the emergency and back up lighting system and eliminates the necessity for more expensive components. The demands on the emergency and evacuation lighting are specified in the relevant standards and must be observed in the construction of the complete system.

### Lightning protection

Subterranean objects that are connected to the surface are highly susceptible to the effects of atmospheric electricity. The prime reason is that the cables and electronic components basically serve as lightning conductors that direct the electrical discharge into the ground. Sometimes it is difficult to predict the possible path of the discharge. Therefore, a correct and reliable lightning conductor must be integrated in all subterranean systems. All protection levels are to be observed. Theory and practice are described in detail in the relevant regulations that must be correctly understood and adhered to. Money should not be saved on safety elements in components of underground installations.

### Manufacture, Testing and Quality Control

Correctly conducted tests are the key to good quality and long life of the units employed underground.

A complete testing process consists basically of the following single test elements:

- Test in the natural surroundings over several months
- Tests in the natural surroundings in a subterranean lake
- Tests in accordance with IP67 EN 60529
- Test for resistance against chemicals
- Long term test over 1 year in sea water
- Test in accordance with the demands of IP68
- Submerged test over 6 months
- Battery test over 24 hours
- Seal test at 3 bar for 2 hours

Every manufactured lamp should be tested for seal tightness and subjected to a technological operation test. The light parameters must also be measured. These are necessary procedures to guarantee the quality and long life of the products. When necessary the lamps can be calibrated.

### Summary

The main purpose of a lighting system in a show cave is to ensure the safety of the visitors whilst providing a maximum of aesthetic effect and minimal impact on the cave's ecology. The LED lighting should remain inconspicuous in the show cave but must be protected from the cave's atmosphere. The use of modern technology and

technical solutions bring serious changes to the world of illuminating subterranean points of interest that seemed so simple just a few years ago. When designing and installing modern lighting systems a list of important demands have to be observed.

Important demands that need to be considered:

- A great deal of light is unnecessary. A combination of diffuse and directed light with topical focus suffices
- Lighted periods should be reduced to a minimum. This is necessary not only in order to protect the environment but also to reduce costs through higher energy efficiency. It also enhances the attraction when objects are illuminated separately and not all at once
- The installation should be as invisible as possible. Visitors should be impressed by what they see during the guided tour and not by a display of electrical appliances
- The selected lamps and all other units must be suitable for operation within a cave
- Controllable light should intensify the emotional effects
- The necessary measure of safety for visitors and that demanded by regulations must be ensured

LED light brings a new quality to modern subterranean exhibitions, portrays their natural beauty in a new manner and creates unforgettable, even three-dimensional, effects. It is important to exploit this new quality correctly. ■

To guarantee the appropriate quality for the harsh environment of caves, many different tests are performed in the lab and in the natural environment



# guangzhou international lighting exhibition

# 22<sup>nd</sup>

**The most influential and comprehensive lighting and  
LED event in Asia**

## 9 – 12 June 2017

China Import and Export Fair Complex  
Guangzhou, China

[www.light.messefrankfurt.com.cn](http://www.light.messefrankfurt.com.cn)

### Contact

Messe Frankfurt (HK) Ltd

Tel: +852 2238 9969

Fax: +852 2519 6079

[light@china.messefrankfurt.com](mailto:light@china.messefrankfurt.com)



光亞 · Guang ya



messe frankfurt

# LED professional Review (LpR) Article Index 2016

## COMMENTARY

<b>Design Beyond FFF</b> by Ed van den Kieboom, InnovationFab Events	LpR 53 - Jan/Feb   p 08
<b>ZHAGA Meets Smart Lighting</b> by Dee Denteneer, Secretary General of the Zhaga Consortium	LpR 54 - Mar/Apr   p 08
<b>LFI 2016 Touts LED Lighting and Digital Control Technology Transformation</b> by Dr. Nisa Khan, President of IEM LED Lighting Technologies	LpR 55 - May/June   p 08
<b>Lifetime and Reliability</b> by Dr. Günther Sejkora, items & LED professional	LpR 56 - June/Aug   p 08
<b>The Good the Bad and the Ugly</b> by Ruairí O'Brien, Federation of International Lighting Designers	LpR 57 - Sept/Oct   p 08
<b>Review of the LED Lighting Design Approach</b> by Justin Jiang, UniBrite Technology	LpR 58 - Nov/Dec   p 08

## TECH-TALKS BREGENZ

<b>Wolfgang Nemitz, Scientist, Joanneum Research</b> compiled by Siegfried Luger, LED professional	LpR 53 - Jan/Feb   p 24
<b>Karl Jónsson, IoT Architect, Tridonic</b> compiled by Arno Grabher-Meyer, LED professional	LpR 54 - Mar/Apr   p 38
<b>Dr. Biing-Jye Lee, Chairman of Epistar</b> compiled by Siegfried Luger, LED professional	LpR 55 - May/June   p 30
<b>Francis Wong, Associate VP Lighting Business Unit, Lextar</b> compiled by Dr. Günther Sejkora, LED professional	LpR 56 - June/Aug   p 34
<b>Sebastian Huelck, Director Lighting, EBV Elektronik</b> compiled by Dr. Günther Sejkora, LED professional	LpR 57 - Sept/Oct   p 32
<b>Prof. Christian Cajochen, Univ. Basel, Head of Center of Chronobiology</b> compiled by Dr. Günther Sejkora, LED professional	LpR 58 - Nov/Dec   p 26

## EVENTS

<b>Light + Building Post Show Report: The Six Most Noteworthy Observations</b> by Arno Grabher-Meyer, LED professional	LpR 55 - May/June   p 36
<b>LpS 2016: A Perfect Platform for New Ideas and Innovations</b> by Arno Grabher-Meyer, LED professional	LpR 58 - Nov/Dec   p 40

## RESEARCH

<b>Human-Focused Outdoor Illumination: Trade-Off Between Pleasing Color and Circadian Action</b> by Dr. Pranciškus Vitta, Vilnius University	LpR 53 - Jan/Feb   p 30
<b>White Hybrid Light-Emitting Diodes: A Plausible Solution for Commercialization and Health Issues</b> by Rubén D. Costa et al., University of Erlangen-Nuremberg (FAU)	LpR 53 - Jan/Feb   p 36
<b>Thin-Film Light Management System for Intelligent Large-Area LED Luminaires</b> by Oscar Fernandez, Centre Suisse d'Electronique et de Microtechnique	LpR 54 - Mar/Apr   p 46
<b>Luminescent Glasses and Glass Ceramics for White Light Emitting Diodes</b> by Franziska Steudel et al., Fraunhofer Institute	LpR 55 - May/June   p 48
<b>Quality and Health Aspects of LED Lamps for the European Residential Lighting Market</b> by Prof. Dr. Georges Zissis, Paul Sabatier University of Toulouse	LpR 56 - June/Aug   p 40
<b>Flicker Beyond Perception Limits - A Summary of Lesser Known Research Results</b> by Dr. Walter Werner, Werner Consulting	LpR 56 - June/Aug   p 50
<b>Sky Luminance and Radiance Distribution Patterns: Empirical Assessment and Computational Models</b> by Univ. Prof. Dipl.-Ing. Dr. Ardeshir Mahdavi et al. TU Vienna	LpR 57 - Sept/Oct   p 40
<b>The Perspective of Bio-Hybrid White Light-Emitting Diodes Based on Rubber-Like Down-Converting Coatings</b> by Dr. Rubén D. Costa et al., University of Erlangen-Nuremberg (FAU)	LpR 58 - Nov/Dec   p 32

## TECHNOLOGIES

<b>Light Flicker from LED Lighting Systems - An Urgent Problem to Solve</b> by Prof. Georges Zissis, LAPLACE Université de Toulouse	LpR 53 - Jan/Feb   p 50
<b>Create Colorful and Bright LED Light with an LED Matrix Dimmer</b> by Keith Szolusha, Linear Technology	LpR 54 - Mar/Apr   p 62
<b>Cost and Performance Optimization of Thermal Management Solution for High Power LEDs</b> by Giles Humpston, Cambridge Nanotherm	LpR 55 - May/June   p 60
<b>Concepts to Overcome Lifetime Issues of LED Drivers</b> by Maggie Nadjmi, SL Power Electronics	LpR 56 - June/Aug   p 58

<b>Technologies for Engineering an LED Light Closest to Sunlight</b> by Masahiko Yamakawa, Toshiba Materials	LpR 57 - Sept/Oct   p 68
<b>Comparing New Dielectric Materials for Chip-on-Board LED Packages</b> by H. Zhang, M. Wagner & Prof. T. Quoc Khanh, TU Darmstadt	LpR 58 - Nov/Dec   p 50
<b>Structured Glass Light Guides for Efficient Lighting</b> by Christian Passlick, Auer Lighting	LpR 58 - Nov/Dec   p 54
<b>ENGINEERING</b>	
<b>How to Design with LEDs: Concurrent Engineering Yields Fully Optimized Lighting Systems</b> by Brian S. Jasenak, Kopp Glass	LpR 57 - Sept/Oct   p 52
<b>Easing Lighting System Design with Online Tools</b> by Patrick Durand, Future Lighting Solutions	LpR 57 - Sept/Oct   p 58
<b>CONNECTED LIGHTING</b>	
<b>Advanced Bluetooth 4.0+ -Based Smart Lighting Technology</b> by Saara Guastella, Casambi	LpR 54 - Mar/Apr   p 52
<b>Power over Ethernet Lighting for Commercial Buildings</b> by Giovanni Frezza, Molex	LpR 54 - Mar/Apr   p 56
<b>MANUFACTURING</b>	
<b>Potting Processes as a Part of LED-Based Lighting Module Manufacturing Methods</b> by Willi Huber, ViscoTec Pumpen- u. Dosiertechnik	LpR 55 - May/June   p 52
<b>APPLICATIONS</b>	
<b>The Role of Special Optics in Human Centric Lighting and Architecture</b> by Anthony Ang, Suleyman Turgut & Mary Ann Giorgio, Luminit	LpR 53 - Jan/Feb   p 60
<b>Safety Concept for LED Street Lighting</b> by Andreas Schamber, Phoenix Contact	LpR 54 - Mar/Apr   p 68
<b>Illuminating Education - Providing a Brighter Future for Students</b> by Jay Black, Revolution Lighting Technologies	LpR 54 - Mar/Apr   p 72
<b>High-End White Light Sources Fiber Optics Technology for Medical Applications</b> by Holger Laabs, Oliver Mehl & Henning Rehn, Osram	LpR 56 - June/Aug   p 68
<b>Lighting Fabrics - A New Approach for Flexible Light Sources</b> by Till Sadlowski, Carpetlight	LpR 57 - Sept/Oct   p 76
<b>QUALITY</b>	
<b>TM-30 or the Quest for New Metrics to Measure Light Color Quality</b> by Arno Grabher-Meyer, LED Professional	LpR 56 - June/Aug   p 62
<b>Flicker: Standards and Test Methods</b> by Walter Parmiani, UL International Italia	LpR 58 - Nov/Dec   p 64
<b>ENVIRONMENT</b>	
<b>Botanical Light Pollution - Red is the New Blue</b> by Ian Ashdown, byHeart Consultants & Lighting Analysts	LpR 57 - Sept/Oct   p 82
<b>INNOVATION</b>	
<b>On-Chip Beam Forming Optics Paves the Way for New Luminaire Designs</b> by Paul Drosihn & Samir Mezouari, Plessey Semiconductors	LpR 58 - Nov/Dec   p 60
<b>TRENDS</b>	
<b>Embedded Lighting - Developing New Lighting Applications for Modern Architectural Projects</b> by Brad Koerner, Philips Lighting	LpR 53 - Jan/Feb   p 44
<b>Smart Lighting Market and Technology Trends</b> by Jasmine Hinduja, The Insight Partners	LpR 58 - Nov/Dec   p 70
<b>SPECIAL</b>	
<b>The Value of Dark Skies - About Environmentally Friendly Lighting</b> by J. Scott Feierabend, International Dark-Sky Association (IDA)	LpR 54 - Mar/Apr   p 80
<b>More Efficient Plant Growth with Quantum Dots</b> by Dale Needham, Nanoco Lighting	LpR 55 - May/June   p 64
<b>LED Lamps Recycling Technology for a Circular Economy</b> by A. Gassmann et al., Fraunhofer IWKS & Technische Universität Darmstadt	LpR 56 - June/Aug   p 74
<b>LEDs Reveal Paintings Hidden in Paintings</b> by Clint Eccher, Artist, Arno Grabher-Meyer, LED professional	LpR 57 - Sept/Oct   p 90



## LED professional Review (LpR) - Annual Subscriptions

### LpR Digital Magazine

- 6 issues
- pdf download
- high resolution pictures and graphs
- printable
- commercial use
- access to all previous issues
- Euro 78.80

### LpR Printed Magazine

- 6 issues
- Euro 158.40

<http://www.led-professional.com/subscription>

### Cover-page

Artwork: Thomas Klobassa,  
©LED professional 2016

Main Images: Arno Grabher-Meyer,  
LED professional



Smart luminaire FLUXO from Luke Roberts at the LpS 2016



Light control app for the FLUXO luminaire running under iOS or Android

## Next LpR SYSTEMS & SOLUTIONS Issue 60 - March/April 2017

### TECH-TALKS BREGENZ

Norman Bardsley - President of Bardsley Consulting, Consultant for DoE & ISA

Norman Bardsley is currently focused on diffuse lighting applications of OLEDs and LEDs, flexible substrates and printed electronics. He authored several reports on OLED technology and co-edited the DoE "Manufacturing Roadmap" and "Multi-Year Program Plan" for SSL including OLED. Questions on technical challenges if progress in OLED development slows down and the future evolution of OLEDs and cost trends are addressed. ■

### APPLICATION TECHNOLOGY

Biological Light Exposure for Humans, Animals and Plants

Mood lighting is often misleadingly interpreted as HCL. But HCL is much more because it includes biologically effective light that is beneficial or dangerous, depending on the correct application. While the relevant parts of the radiation spectrum may differ, light is also biologically effective for plants and animals and it is used to achieve well-defined effects. The authors present examples, discuss similarities and differences between humans, animals and plants in respect to the relevant spectra, and scrutinize possible consequences. ■

### RESEARCH

"Best Papers" at LpS 2016:  
Optimization of Roadway Lighting Optics for Environment Adaptive Spatial Light Distribution with Two Channel Independent Dimming Control

Meeting all lighting requirement standards for European roadway lighting optimized for both dry and wet tarmac surface conditions would be very beneficial. With common concepts the lifetime of the two separate channels needed is very different. The new method allows designing two optical light engines that are controlled to achieve the defined performance with aligned lumen depreciation, providing an outstanding lighting experience in various environmental conditions. ■

Lead Halide Perovskite Nanocrystals: A New Promise for Light Emitting Devices

Perovskites structured materials have attracted scientific and technological interest in the last four years. Recent studies have shown that these materials could deliver high photoluminescence efficiency at any desired wavelength in the visible spectrum. This review focuses on the application in single color LEDs (red, green and blue) and white emitting color-converting layers. It discusses what limits their application in everyday technology like toxicity and limited functional stability. ■

subject to change

## Imprint

LED professional Review (LpR), ISSN 1993-890X

### Publishing Company

#### Luger Research e.U.

Institute for Innovation & Technology  
Moosmahdstrasse 30  
A 6850 Dornbirn, Austria / Europe  
phone +43 5572 39 44 89  
fax +43 5572 20 60 70  
info(at)lugerresearch.com  
www.lugerresearch.com

#### Publisher

Siegfried Luger +43 699 11 33 55 70  
s.luger(at)led-professional.com

#### Editor-in-Chief

Arno Grabher-Meyer +43 699 11 33 55 18  
a.g-m(at)led-professional.com

#### Int. Account Manager

Theresa Koenig +43 699 11 33 55 20  
theresa.koenig(at)led-professional.com

#### Marketing & Sales Manager

Theresa-Anna Luger +43 699 11 33 55 19  
theresa.luger(at)led-professional.com

### Your Local Contacts

#### China, Hong-Kong

Iris Yuen +86 1380 27 01 367  
irisyuen88(at)gmail.com

#### Germany & Switzerland

Armin Wezel +49 30 526 891 92  
armin(at)eurokom-media.de

#### Japan

Eiji Yoshikawa +81 3 6751 0090  
scala(at)s3.dion.ne.jp

#### South Korea

Jung Won Suh +82 2 78 58 222  
sinsegi-2(at)sinsegi-media.info

#### Taiwan

Leon Chen +886 2 256 81 786-10  
leon(at)jkmmedia.com.tw

#### United Kingdom, France & Benelux

Zena Coupé +44 1923 85 25 37  
zena(at)expomedia.biz

#### US East

Karen C Smith-Kernc +1 717 397 7100  
KarenKCS(at)aol.com

#### US West & Canada

Alan A. Kernc +1 717 397 7100  
AlankCS(at)aol.com

## Copyrights - Luger Research e.U.

The editors make every reasonable effort to verify the information published, but Luger Research e.U. assumes no responsibility for the validity of any manufacturers, non profit organisations or individuals claims or statements.

Luger Research e.U. does not assume and hereby disclaims any liability to any person for any loss or damage caused by errors or omissions in the material contained herein, regardless of whether such errors result from negligence, accident or any other cause whatsoever. You may not copy, reproduce, republish, download, post, broadcast, transmit, make available to the public, or otherwise use LED professional Review (LpR) content without prior written consent from Luger Research e.U. - Institute for Innovation & Technology, Austria. ■



**!** GET YOUR FREE E-MAGAZINE  
[www.led-professional.com/free](http://www.led-professional.com/free)



# Trends & Technologies for Future Lighting Solutions.

LEDs • OLEDs • Light Engines • Lighting Modules • Optics • Drivers • Thermal Management • Lamps • Fixtures • Production & Measurement Equipment  
 Project Reports • Patent Reports • Research Reports • Event Reports

**LED**  
 professional

MORE THAN  
**31,500**  
 READERS

[www.led-professional.com](http://www.led-professional.com)

powered by Luger Research e.U.

Submit your article. Please contact Arno Grabher-Meyer, Editor in Chief, at [a.g-m@led-professional.com](mailto:a.g-m@led-professional.com)

# ACEVEL



Fair: USA SIL Lighting  
Booth: Booth 624  
Hold in: Anaheim, CA  
Time: Feb 28 - March 2, 2017

ACEVEL GROUP | [www.acevel.com](http://www.acevel.com) | [info@acevel.com](mailto:info@acevel.com)