

Tech-Talks Bregenz: Fred Maxik

Research: Lifetime Simulation & Optimization

Technologies: LED Overvoltage, LED Drivers

Application: Thermal Management

FUTURE
Lighting Solutions
www.FutureLightingSolutions.com
2018 LIGHTFAIR International
May 6 – 10, 2018, Booth #837
light+building
18.-23.3.2018 Frankfurt am Main
Hall 4.1, Stand G10

The choice for color has never been more black and white.



There are architectural and entertainment lighting designs where optimal color isn't just a luxury—it's an absolute necessity. Fortunately, our LUXEON Color LED Family is up to the challenge. With the most complete spectrum of colors—from Red, Green, Blue to even Lime—and an unmatched quality of light, LUXEON Color LEDs are the clear choice.

When color matters, look to LUXEON Color LEDs to make your boldest designs shine.

Visit lumileds.com/color to learn more.



LUMILEDS ILLUMINATION LEDs

LUXEON HIGH POWER LEDs • LUXEON MID POWER LEDs • LUXEON CoB LEDs • LUXEON COLOR LEDs • MATRIX PLATFORM

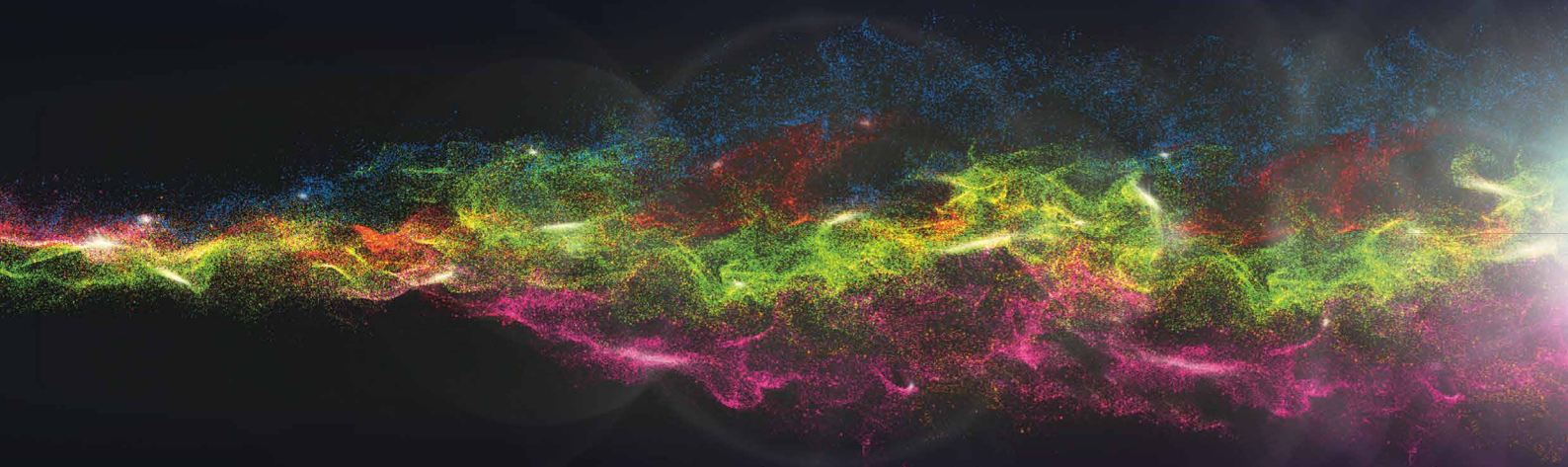

Visit us at
Hall 6.2
Booth C04
and
Hall 2.0
Booth B50

Light + Building 2018

Discover our Spectrum of Infinite Possibilities

Join us at our Booth C04 in Hall 6.2 to experience firsthand our broad variety of components and applications for various areas of competence. We look forward to welcoming you from March 18th to the 23rd, 2018.

And don't miss us at the OSRAM Booth B50 in Hall 2.0.

Light is OSRAM

OSRAM
Opto Semiconductors



An IP SnapShot Into Lighting

The lighting industry is facing enormous challenges and new stakeholders have started to enter this traditional market. With the advent of LED lighting and the whole world of smart, intelligent and connected lighting, the boundaries have also changed and even more uncertainties have arisen.

As we know, what we see and recognize on the market today was developed years ago in labs and at research institutes. Can we get a better understanding of the trends when screening the IP portfolios? The first thing we did was analyze the IPC class F21, which is assigned to lighting. Japanese companies have been the most active players in the last few years. Companies such as Panasonic, Toshiba, Koito, Sharp and Stanley are dominating the lighting IP field. Ocean's King Lighting shows strong activities lately and together with Foxcoon they belong to the major IP players representing China. Philips has been showing strong, continuous IP activities since 2008. Of course this picture changes when we analyze certain areas in lighting. This gives us an overview of the complete lighting field of the IPC class F21.

A closer look into the numbers of patent families for certain technology fields or keywords of the past 5 years showed the following results for the main IPC class F21:

LED (82,805), Connectivity (49,590), Optics (9,427), Production (7,182), Protection (7,053), Fluorescent (4,148), Safety (3,514), Thermal (3,182), Driver (2,579), Intelligence (2,530), Security (2,250), Laser (1,668), Quality (1,466), Phosphor (1,063), Modularity (1,001), OLED (566), Recycling (250), Internet (189), Software (141), and Sustainability (73).

The results show the importance of connected solid-state-lighting and the focus on producibility and quality aspects. On the other hand, there is room for more inventions in the filed of new light source technologies and sustainable lighting concepts.

The Light+Building fair in Frankfurt is soon and will be a good opportunity to compare the concrete industry developments with the picture of trends we have in mind. The LED professional team will be there as well and invite you to get in touch with us for a one-on-one meeting.

LpR issue #66 covers a lot of the above key topics including lifetime and protection issues and a very interesting interview with Fred Maxik.

Have a great read!

Yours Sincerely,

Siegfried Luger
Publisher, LED professional

It is not just men's rear ends that women stare at nowadays, but cars', too – thanks to PLEXIGLAS®.

What does a leading specialty chemicals group have to do with car design? For over 60 years, Evonik, with its PLEXIGLAS® molding compounds, has been a driving force behind the auto industry. Why? Because the multifaceted ways in which PLEXIGLAS® can be formed open up virtually endless possibilities for design. One shining example is transparent and colored PLEXIGLAS® whose top transmission properties and color stability make for automotive lighting that's as striking as it is innovative. For more inspirational PLEXIGLAS® products, go to www.plexiglas-polymers.com.

PLEXIGLAS® 



 **EVONIK**
POWER TO CREATE

COMMENTARY

08 On Smart Luminaires
by Prof. Tran Quoc Khanh, Technical University Darmstadt

TECH-TALKS BREGENZ

34 Fred Maxik, Founder & CTO, Lighting Science Group
compiled by Dr. Guenther Sejkora, LED professional

RESEARCH

40 Lifetime- and Economic Efficiency Simulation of LED Luminaires in Dymola/Modelica
by S. Haemmerle & T. Schmitt, University of Applied Sciences Vorarlberg

50 Full-Color InGaN/AlGaIn Nanowire LEDs for SSL and Displays
by M. R. Philip & Dr. H. P. Nguyen, New Jersey Institute of Technology

EVENTS

56 Technology Is the Answer, But What Was the Question?
by Arno Grabher-Meyer, LED professional

TECHNOLOGIES

62 A Near Infrared Enhanced LED Lighting Approach
by Scott Zimmerman, Silas

ENGINEERING

70 Electrical Over Stress - How to Prevent an LED Failing Earlier than Expected
by Mauro Ceresa, Cree

80 Method and Circuit to Maintain Constant Light Output for LED Luminaires
by Prof.Dr.Eng. Stelian Matei, Electromagnetica

REGULARS

04 EDITORIAL
08 COMMENTARY
10 COMPONENTS NEWS
26 APPLICATIONS NEWS
27 RESEARCH NEWS
32 CIE RESEARCH

90 ABOUT | IMPRINT

HIGHLIGHTS

50 Full-Color InGaN/AlGaIn Nanowire LEDs for SSL and Displays
by M. R. Philip & Dr. H. P. Nguyen, New Jersey Institute of Technology

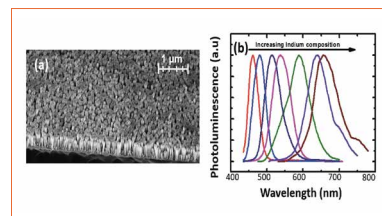

80 Method and Circuit to Maintain Constant Light Output for LED Luminaires
by Prof.Dr.Eng. Stelian Matei, Electromagnetica

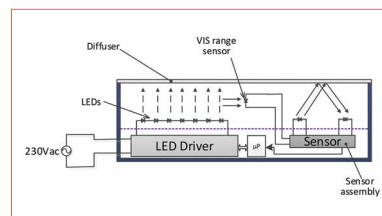

ADVERTISING INDEX

| | | | | | |
|---------------------------|----|---------------------------|----|------------------------------------|----|
| FUTURE LIGHTING SOLUTIONS | 1 | LACKWERKE PETERS | 19 | SEOUL SEMICONDUCTOR | 55 |
| LUMILEDS | 2 | LACKWERKE PETERS | 19 | LUMINUS DEVICES | 67 |
| OSRAM | 3 | EPISTAR | 21 | FLS-PHILIPS | 69 |
| EVONIK | 5 | INTERLUMI PANAMA | 23 | FLS-NICHIA | 73 |
| LEDFRIEND | 7 | FUTURE LIGHTING SOLUTIONS | 25 | GUANGZHOU INT. LIGHTING EXHIBITION | 75 |
| LPS | 9 | ELECTROLUBE | 27 | CREE | 79 |
| OPHIR SPIRICON | 11 | INSTRUMENT SYSTEMS | 28 | A.A.G. STUCCHI | 83 |
| HELVAR | 13 | ADELS CONTACT | 29 | FULHAM | 87 |
| INFINEON | 14 | LEDIL | 30 | LIGHT FAIR INTERNATIONAL | 89 |
| WAGO | 15 | OSRAM | 31 | LPR | 91 |
| FISCHER ELEKTRONIK | 17 | TIL | 49 | WÜRTH | 92 |
| CREE | 18 | INSTRUMENT SYSTEMS | 53 | | |

Redefine High Bay Driver with

- 01 Smart Sensor
- 02 Remote Control
- 03 Efficiency Up to 95%
- 04 Stand-By Power < 1W



Smart Application Scenarios

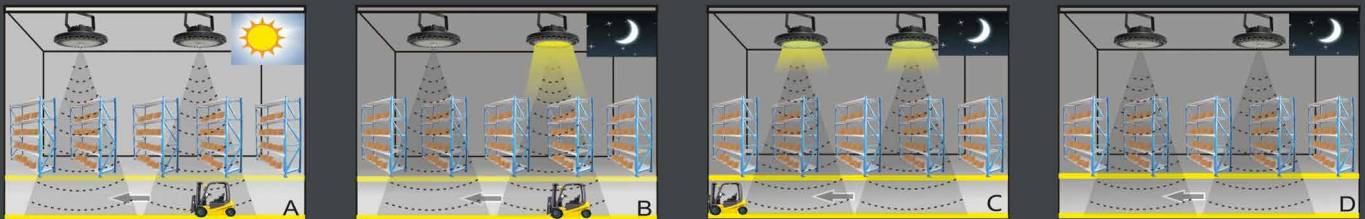

LIFUD High Bay Driver with the SMART SENSOR

1. Smart Sensor = Microwave Sensor + Light Sensor
2. IP65 waterproof. Compact size. Can be integrated into the high bay light fixture.
3. After installation, a REMOTE CONTROL helps to set different reactions of the sensor and the light under different conditions, including:
 - ◆ The brightness level
 - ◆ The light-on time
 - ◆ The induction zone
 - ◆ How the brightness changes according to different daylight levels
 - ◆ The remote control itself can control the on/off and the brightness of the light fixture. Besides, there are 4 buttons for 4 default scenes.

Frankfurt light+building Fair 2018
Hall: 10.1 Booth No.E65
Fair date: 18 to 23 Mar. 2018

www.lifud.com E-mail: sales@lifud.com Tel: +86 755 8373 9299



Prof. Tran Quoc Khanh

Prof. Khanh studied machine engineering and technical optics before he finished his Ph.D. thesis on the spectroscopy of UV-VIS radiation sources in 1989. Then he worked at Krochmann in Berlin, at Gigahertz-Optik and at Arnold & Richter Cinetechnik in Munich before his habilitation in 2005. Since then, he is professor for lighting technology and solid-state lighting at the Technical University Darmstadt. He leads LED-research projects of the German Central Association for Electro Technical Industry (ZVEI) and he is chairman of the International Symposium for Automotive Lighting Technology (ISAL). He recently published books on “Digital Color Imaging”, “Color Rendering Quality of Conventional and SSL Light Sources” and “LED Technology and Perception”.

ON SMART LUMINAIRES

In the time up to 2010, conventional luminaires with low or high-pressure discharge lamps with a luminous efficacy of about 80 lm/W were developed. The electrical power was dependent on the electrical power of the lamps built in the luminaire. From 2008 and likely until around 2020, luminaires with phosphor-converted white LEDs with one fixed color temperature, a constant luminous intensity distribution and a maximal luminous efficacy of about 140-160 lm/W are developed with an electrical power between 10 W and 300 W for different applications and dependent on the manufacturer. Therefore, a relative increase in luminous efficacy of 80 -100% in the context of the discussions on “energy efficiency” is being achieved.

Since 2014 the international lighting community has discussed the HCL concept on one side and smart lighting on the other side. In this discussion process the focus is the development of technologies like Zigbee, Bluetooth or Thread. Sensor concepts have the aim of dimming the light in the illuminated space if the user is absent or if the natural light's incidence through the windows is enough or it is increased by daylight optical systems (prisms, mirrors). In a general sense, these technologies are useable for energy reduction and communication technology tools. However, the question arises: is this the smart lighting of the future?

Smart lighting has to take several different viewpoints into account. First, the user's illuminated space (e.g. a building, a hospital or a school) always contains an application context (e.g. the atmosphere of an office, of medical care or education), depends on geographical location, the building's geometry and weather and it may be oriented in different directions (North, South, East or West). The users who work in these illuminated spaces may have different cultural roots, different ages, genders as well as various working tasks (e.g. a nurse working in different patient rooms) under different physiological and psychological conditions depending

on the current time of the day and season. On the other hand, from the lighting engineer's point of view, the smart luminaires of the future should change their luminous intensity distribution (to provide direct and indirect lighting zones), their spectra (color temperature, white point, saturation of the illuminated objects, color gamut) and their brightness in the relevant living or working areas depending on the time of the day. Now the question is how lighting engineers will put these systematic changes into practice.

This question can only be answered at the level of lighting science, psychology and sleep research. Current standards and regulations define illuminance and luminance, glare and homogeneity within the lit environment based on the classic knowledge of the time until 1980. In the meantime, the dynamic development of LED technology gave rise to the usage of more modern lighting quality parameters like brightness, visual clarity, the circadian stimulus and color quality (e.g. CRI according to CIE 2017, color gamut or color saturation, preferred color temperature). Although these parameters are well established, currently they do not find their way into international standards. For these parameters, minimum criterion values have to be specified for user acceptability in order to ensure the lighting quality of the smart luminaires of the future.

Beyond classic production methods, the smart luminaires of the future should consist of a number of modules of the same electronic and software architecture and they should be scalable to a new modular luminaire. Many luminaires of this smart type in a room shall perform different lighting tasks depending on their position in the room (e.g. next to the windows, the doors or at the walls) and communicate with each other via different communication channels (e.g. VLC). The lighting procedure should then be controlled by a motherboard connected to the Internet platform within each lighting period (e.g. 10 minutes or half an hour). ■

T.Q.K.

LpS 2018

LED SYMPOSIUM
professional +EXPO



***The lighting event
for technologies
of tomorrow***

LpS is Europe's leading international lighting technologies conference and exhibition for **DESIGN, TESTING** and **PRODUCTION** of lighting systems, controls and equipment.

8th International LpS | September 25th - 27th 2018 | Bregenz | Austria

Organized by

LUGER RESEARCH
Institute for Innovation & Technology

Co-hosted with



www.lps2018.com

New Osram IR LED for Facial Recognition

Smartphones, tablets and the like can now be unlocked in very different ways: with a password, fingerprint scan or even an iris scan. 2D facial recognition is another method and involves illuminating the user's face with an infrared light source and capturing the image with an IR camera. The system then compares the image with the images previously stored for the purposes of identification, focusing on characteristic two-dimensional features. If there is a match for the various data such as the width of the mouth, length of the nasal ridge and distance between the eyes then the device will be unlocked.

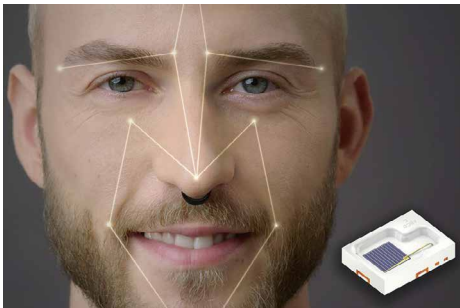

Osram's Synios P2720, the first infrared LED with 940 nm for 2D facial recognition, provides bright and uniform illumination of the user's face

By using a wavelength of 940 nm, Synios P2720 reduces the red glow that can occur with infrared light sources in the short-wave infrared range. Up to now, the sensitivity of IR cameras was only good if the light source had a wavelength of 850 nm. The cameras have been further developed to give them greater sensitivity in longer wavelength ranges so 940 nm light sources can now be used – which in turn improves the overall performance of the system.

Bright and uniform illumination of the user's face or eyes is particularly important for facial recognition and also for eye-tracking systems. Synios P2720 offers impressive performance with an output of 1,150 mW at 1 A. Thanks to this high overall output it has a radiant intensity of 360 mW/sr.

The new Synios P2720 has the same footprint as the 850 nm version. Measuring only 2.0x2.75x0.6 mm, the IRED is therefore ideal for space-critical applications.

The IRED has no optics. Its compact dimensions mean that customers can install secondary optics in line with their requirements.

"Everyone wants the reassurance that the data on their mobile devices is as secure as possible", explained Nina Reiser, Marketing Manager for the Emitter Laser Sensor segment at Osram Opto Semiconductors. "Our extremely powerful and bright IRED illuminates the facial characteristics of users perfectly, ensuring that only authorized persons have access to the device."

This IRED for 2D facial recognition is the latest addition to Osram Opto Semiconductors' existing portfolio for biometrics. The new Synios P2720 is already available for initial customer projects. ■

Everlight Demonstrates New Signage LEDs

Everlight Electronics Co., Ltd., a leading player in the global LED and optoelectronics industry, attended Integrated Systems Europe for the first time to demonstrate signage LED components for indoor and outdoor applications including all dimensions, packages, viewing angles, and performances. The HNB2727, HNB1921, HNB1515 series for outdoor applications as well as 18-035(0505) for indoor signage achieve true color in high resolution with advanced technologies and have passed multiple reliability certificates.

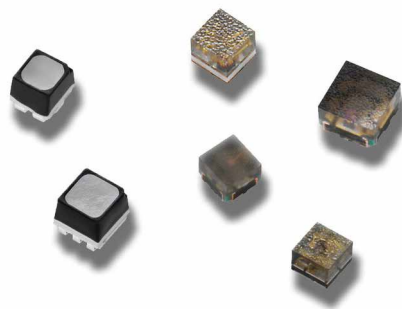

Everlight extended its broad portfolio of LEDs for indoor and outdoor signage applications at "Integrated Systems Europe"

For outdoor signage applications, Everlight provides PLCC and Lamp packaged products. The PLCC-packaged series HNB2727, HNB1921 and HNB1515, as well as a RGB full-color LED series in PLCC, use an enhanced structure and ink brush/dark support to effectively promote the screen consistency and contrast. All outdoor signage modules installed at

our booth demonstrate best water-proofing. The HNB2727 series is especially suitable for signage applications with a pitch of P5-P8 mm. The HNB1921 and HNB1515 series are suitable for outdoor applications with a pitch of P2-P5 mm. In addition, Everlight also provides LEDs for outdoor signage in lamp packages with narrow viewing angles and different sizes. Everlight's outdoor LED series have all passed a 3000 hour reliability test and proved luminous decay less than 10%. They are certificated with IPX8, provide UV and sulfur resistance, and wide viewing angles to present display effects with maximum resolution.

Everlight has been promoting fine-pitched LEDs for signage since 2010. As a product leader in LED packaging, we continuously miniaturize LEDs to ever smaller pitches. The 18-035 (0505) and 18-036 (0606) series are RGB LED packages with the latest minimal size. By repeated high-density design verification, we can implement a pitch of P0.7mm to achieve seamless connection at micro pitch and true color. Products with small pitch must pass 13 reliability tests and luminous decay less than 5%. Everlight is the first enterprise in the industry to have passed an 8000 hour reliability test.

For the part of special signage, Everlight developed pixel sharing (virtual pixel) and see-through screen applications. The 19-049 RGGB model, designed with pixel sharing, can simultaneously drive chips in different LED packages by doubling the scanning frequency of the IC and reach the virtual effect of a P0.6mm high-density pixel for a panel in terms of vision persistence. Such pixel sharing can achieve the desired screen effect with micro pitch without increasing the mounted quantity of LED and SMT. For see-through screen applications, top-view LEDs are commonly used on the market. Yet Everlight's 99-235 and 22-23 side-view series provide smaller emission gaps in the see-through screen and a more three-dimensional stereoscopic display – a landscaping priority of core landmark and business districts worldwide.

By combining the R&D, business, and market teams, plus the professional ability in the industry for over 35 years, we continuously pursue innovation and breakthroughs on the package technology so as to provide perfect products for customers. ■

American Bright - New RGB LED Packages with Built-in IC

American Bright announced a new series of PLCC 5050 / 3530 RGB LED chips. The RGB PLCC chip has an integrated circuit that features self-detection signal, support for continuous oscillation, and pulse with modulation (PWM) output that can maintain static screen.



The integrated circuit of American Bright's new RGB LEDs features self-detection signal

Features and Benefits:

- Synchronous of two-lane
- 8-bit (256 level) color set
- 5-bit (32 level) brightness adjustment
- Low voltage .2W power consumption
- Built in support for continuous oscillation
- Self-detection signal
- Refresh rate of 400 cycles
- 5050 and 3530 available chip sizes

Applications:

- Large LED display and backlighting
- Soft light bar and rope lighting
- Full color display
- Indoor and outdoor commercial and residential architectural lighting
- Decoration and entertainment lighting
- Gaming Machines

These new devices have a low power consumption of 0.2 W (max: 1 W), applied voltage of 5V and an operating temperature of -40°C to 70°C. The emitted red, green, blue can achieve various color mixes with 8-bit (256 level) color set with 5-bit (32 level) brightness adjustment.

The RoHS-compliant RGB LED chip is well-suited for infrared and vapor phase reflow solder process and automatic SMT pick and place equipment. This new PLCC RGB device features a water clear lens and is ideal for a multitude of applications including indoor and outdoor commercial and residential lighting, light bars, and gaming equipment. ■

LG Innotek Introduces New Flip-Chip Solution

LG Innotek announced that it had succeeded in developing an "advanced flip chip LED package" that demonstrates high efficiency and high luminous flux without deteriorating performance even after it gets through 300°C soldering process.

The company has developed a high quality flip chip LED package that dramatically improves reliability by applying state-of-the-art semiconductor technologies. As a result,

We have squared the (integrating) sphere

FluxGage™

Measures Flux, Color & Flicker of LED Luminaires

- › Designed for testing in production
- › 3x smaller than equivalent sphere
- › Fast, simple and easy to use
- › Cost effective



<http://www.ophiropt.com/led>

See for yourself - Call for a demo.

+ 49 6151 708-0 or toll free 00800 67447678

Ophir Spiricon Europe, Your Local Sales and Service Center.

it became possible to commercialize high efficacy and high luminous flux premium lighting products at both medium and high power.

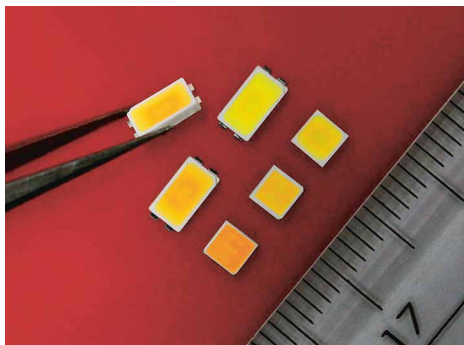

LG Innotek's newly developed "Advanced Flip Chip LED Package" to implement stable 220 lumens per watt efficacy

The flip chip LED has drawn attention of the BLU (Back Light Unit) industry for about 3 years as a high power LED light source because the electrode of the chip is directly attached to the top surface of the PCB substrate without using a connection wire, preventing wire disconnection and ensuring excellent heat dissipation.

The existing flip chip LED packages have been commercialized only as high power LED light sources in the form of CSP (Chip Scale Package) in which reflective white resin is omitted and the process is relatively simple. However, the existing packages distributed in the market have critical problems that the bonding between the chip and the substrate melts to dislocate the chip and reduces the brightness by about 10% when exposed to high temperatures.

It was difficult to ensure the quality of lighting with the existing flip chip LED packages with reflective white resin as the temperature of some of the processes for producing lighting modules and finished products reach 250°C or more.

The new high quality flip chip LED package developed by LG Innotek produces the high efficiency of 220 lumens per watt (lm/W) stably because the bonding between the chip and the substrate does not melt even at a temperature of 250° to 300°C. According to a representative from the company, lighting companies can use this flip chip LED package to produce premium bulbs, tubes and flat-panel lightings without sacrificing the light quality.

LG Innotek developed the flip chip LED package by improving the internal structure of the package, designing its own production process, and enhancing the existing flip chip mounting technology. The internal structure of the chip is newly designed with its proprietary technology to maximize the efficacy and heat dissipation performance.

In addition, the company focused on high quality of the product and conducted a reliability test of more than 6,000 hours. This "high quality flip chip LED package" achieved stable performance even when applied to the high temperature thermal shock at the request of a customer. Due to the strict quality verification process it took 2 years to develop this product, which is considerably longer than the period required for the development of general LED packages.

LG Innotek has applied for 65 new technology patents during the development process. It has taken thorough measures not only to secure its proprietary core technologies but also to help its customers to focus on manufacturing and sales of the modules and finished products without worrying about patent disputes related to the light source.

The company has established a product lineup of "high quality flip chip LED packages" that can be customized according to lighting use. Its main product family consists of middle-power, high efficiency models in middle-power use for each color temperature, such as 220 lm/W class 5630 3 V products and 215 lm/W class 3030 3 V products.

In particular, LG Innotek has strengthened its high power and high luminous flux product lineup by realizing 6 V, 9 V, and 12 V flip chip LED packages in series two and/or two in parallel in the 3030 product family, which were previously difficult to manufacture due to the package design and its processing limitations in the design.

In the future, LG Innotek will continue to launch innovative and unprecedented light source products such as automobile LEDs, UV LEDs, and micro LEDs by leveraging its proprietary core technologies in order to provide differentiated values to customers and lead the market change.

A company official said, "This high-quality flip chip LED package is an innovative product that can advance the reliability of premium lighting to the new level." He also added, "We expect that its application range will be greatly expanded as the product replaces the existing LED packages." ■

New Klaran® WD Series Breaks the \$0.25/mW Price Barrier for UVC LEDs

Crystal IS, a leader in developing high performance UVC LEDs, announced the expansion of its Klaran® platform with the release of the WD series LEDs. Developed specifically for the price and performance needs of POU water disinfection, Klaran WD Series marks the first instance that a UVC LED manufacturer has demonstrated the ability to break the \$0.25/mW price barrier required for mass production of UVC LED based water purification products. The company will initially offer 30 mW and 40 mW variants with plans to introduce more powerful devices in the coming months.

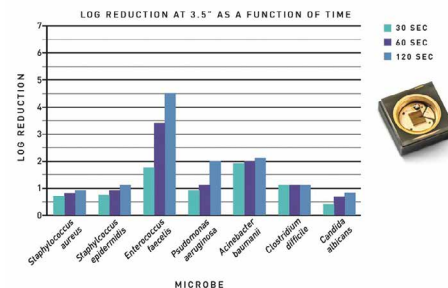

New Klaran® WD series UVC LEDs enable water purifier OEMs to produce cost effective, high performance and mercury-free water disinfection reactors at scale: Log reduction as a function of time for various microbes at 3.5" distance using Klaran UVC LEDs

"Our Aluminum Nitride substrates have always held the promise of superior cost for performance at the deep UV wavelengths," said Larry Felton, CEO of Crystal IS. "Klaran WD series LEDs, developed specifically for point-of-use water, meet OEM requirements at a compelling price per milliwatt to drive innovation in water purification products."

Klaran WD series LEDs enable OEMs to address the rising global demand for water purification products as the surge in industrialization, urban population and rise in water pollution propels consumers to take a more active role in ensuring drinking water quality. This is exemplified in the Asia Pacific

region, specifically China and India. In 2015, the water purifier market in China was valued at \$4.61 billion with expectations that this is likely to reach \$11.21 billion by 2020, growing at a CAGR of 19.45%.

The Klaran Advantage:

Klaran UVC LEDs are produced on a unique ultra-wide bandgap Aluminum Nitride substrate produced by Crystal IS. This substrate overcomes the material challenges inherent with traditional sapphire-based devices and emit their full germicidal power from the top of the chip, allowing for low cost, simpler packaging design. The resulting UVC LEDs offer high output at peak germicidal wavelengths (260-275 nm) and the ability to be operated at high drive currents for more effective disinfection. ■

Lumileds Increases Luxeon 5050 LEDs Performance

Lumileds introduced an upgraded Luxeon 5050 that sets the standard for high lumen per watt (lm/W) for high bay and street lighting applications. With newly released LM-80 reliability data, the product also meets DLC Premium V4.1 requirements, enabling fixture manufacturers' access to high utility rebates and energy savings.



Lumileds' Luxeon 5050 performance breakthrough enables DLC premium fixtures for outdoor and industrial markets featuring the highest flux, efficiency and robustness at excellent cost-per-lumen

Luxeon 5050 features the best performance of all multi-die emitters on the market, reaching flux levels of 350 lm and 175 lm/W at 2 W LED drive conditions (4000 K, 70 CRI at 85°C). But the advantage goes beyond superior flux. The round LES (4.6 mm), eases optic design. "The majority of commercially

available 2 W optics can use Luxeon 5050, which leads to the best flux, efficacy and color over angle combination," said Kathleen Hartnett, Senior Director, Product Marketing at Lumileds. With the industry's lowest thermal resistance (2 K/W), Luxeon 5050 further enhances performance by removing heat and reducing heat sink requirements.

Luxeon 5050 is an ideal choice for high bay and street lighting applications. Typically for high lumen fixtures that require a high lm/W, a group of standard mid power LEDs would be used, with the tradeoff of a large fixture size and weight. Using Luxeon 5050, on the other hand, enables overall smaller system size, which means very compact fixtures are possible. Luxeon 5050 is available in a range of color temperatures (2700-6500 K) and CRI levels (70, 80, 90) to meet a variety of high bay and street lighting as well as indoor spotlighting needs. ■

Nichia Ultra-High CRI White LED - Optisolis™

Since the birth of humans, light (AKARI) has been indispensable. Light generates such a strong feeling, it has kept people throughout history longing for lighting that is most similar to that of natural daylight or fire. To further improve the overall quality of light as "AKARI", Nichia Corporation has developed an Ultra-High Color Rendering white LED named Optisolis™.

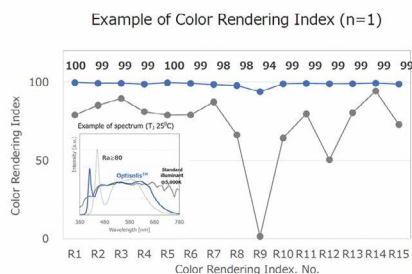

Nichia's new Optisolis™ LED is characterized by an incredibly high CRI which can already be supposed when comparing the 5000 K LED's spectrum with sunlight (inset) due to its almost perfect match

As Nichia continues to lead the industry with innovative products, Optisolis™, which launches in February 2018,

Helvar

First in the world with DALI-2

Open, future-oriented components and technologies for freedom in luminaire design. Your independent, first-class partner.

www.helvar.com

achieves Ultra High CRI with a spectrum that demonstrates the closest match to that of the standard illuminant. Optisolis™, which was first presented to the industry at The Phosphor Global Summit in 2016, is optimized for the general lighting market and is accomplished by using Nichia's own blue chip and phosphor technology.

Manufacturers can utilize Optisolis™ and trust in a spectrum where all colors are reproduced to the color seen under a standard light. Most importantly, since UV emission is essentially non-existent in the spectrum, the degradation of irradiated materials can be reduced dramatically compared to that of other light sources containing UV emission, including other market available LEDs.

Optisolis™ target applications include Museum and Art Gallery Lighting, where the highest CRI is preferred, but UV radiation and light sources can be detrimental. Additional applications could include Color Evaluation, e.g. painting, printing), Commercial Lighting (e.g. retail, etc.) or anywhere Ultra High CRI is desired. ■

Everlight Presents 5630X LED Series

Everlight, a leading player in the global LED and optoelectronics industry, applied its latest technology into the development of the new 5630X Series, a new lighting LED with up to 228 lm/W (5000 K) in luminous efficacy meets the highest luminance requirements of professional commercial and industrial lighting applications.

People today, with an increasing sense for a better quality of life, put more emphasis on the quality of their lighting environment. In order to meet the illuminance and color

temperature requirements that make a space comfortable, Everlight developed its new 5630X Series with a high efficacy of 228 lm/W (@65 mA 5000 K CRI>80), which is in compliance with DLC4.0 standard. After passing HTOL (high temperature operating life) at 105°C, 5630X LEDs can meet L90>36,000 hours and a color shift less than 3SDCM. Compared to standard LED lamps (2000 lm), the 5630X Series can efficiently reduce power consumption by 30-40%. With superior optical efficiency and reliability, the 5630X Series are perfect for professional, commercial and industrial lighting applications.



Everlight's latest 5630X LED series is the industry leading lighting series with highest luminous efficiency of 228 lm/W

For more than 35 years, Everlight has dedicated and devoted its resources to the development of the LED industry. In order to provide an even more comprehensive product portfolio in the lighting field, Everlight now offers a full range of products from mid and high power LEDs to even the ultra high power COB. The 5630X is designed with a long term experience on development and testing processes that focuses on improving the efficacy, form factor, cost-performance ratio and heat dissipation to meet different design demands. Everlight's pursuit of high technology and quality combines

the supply chain's upstream and downstream core competence effectively to deliver products at a high capacity and low cost with fast services, providing competitive cost-performance ratio and excellent service to our highly valued customer.

Samples Available: Yes. (Upon request according to customers' requirements) - Mass Production: now (Q1/2018). ■

Plessey - Monolithic microLED Displays

Plessey Semiconductor, a leading developer of award-winning optoelectronic technology solutions, announces its commitment to being the first to market with a monolithic microLED based display based on GaN-on-Silicon.

Plessey has also commenced an extensive licensing program that will see the company license out its GaN-on-Silicon expertise to microLED manufacturers in line with its new business strategy of becoming the photonic industry's foremost technology platform provider.



There are numerous interesting applications for microLEDs, especially for microLED displays. But with a non-monolithic approach, the placement of LED chips onto a CMOS backplane is a huge challenge



BCR430U Linear low voltage drop LED driver IC

BCR430U is the best choice to drive low power LED strings and strips supplied by a DC voltage source, allowing for more flexibility in voltage headroom, compensating tolerances of LED forward voltage or supply voltage. The voltage drop can typically go down to 135 mV improving the overall system efficiency.

Learn more and download Datasheet!

www.infineon.com/bcr430u



Demand for microLED displays is accelerating with research consultancy Yole Développement forecasting the market could reach up to 330 million units by 2025. GaN-on-Silicon is the only technology platform capable of addressing all of the challenges involved with manufacturing microLED displays in high volumes and cost-effectiveness, Plessey intends to demonstrate its expertise in the field by being the first to manufacture a monolithic display based on microLEDs fabricated using a GaN-on-Silicon approach.

“We made the decision to become a technology platform provider in order to get our technology out to the widest possible manufacturing base to meet this growing demand,” explained Michael LeGoff, CEO, Plessey Semiconductor. “By being the first to market with a monolithic microLED display we will be demonstrating our expertise and the ability to access our proven turn-key solution, enabling manufacturers to ramp up the development and production

of microLED displays to address emerging applications.”

One of the main challenges involved with manufacturing microLED displays using a non-monolithic approach is the placement of LED chips onto a CMOS backplane, currently achieved using pick and place equipment. This involves the individual placement of every LED on a pitch of less than 50µm, requiring new and expensive equipment that is subject to productivity issues. As the pixel density of displays increases and pitch reduces, pick and place becomes less feasible both commercially and technically.

Moving to a monolithic process removes the need for chip placement and will enable smaller and higher resolution displays for a range of applications, including virtual reality (VR), augmented reality (AR), and head-up displays. As the only monolithic solution commercially available, Plessey’s technology doesn’t require pick and

place equipment and isn’t subject to the associated productivity issues.

A fully monolithic approach also supports the integration of the standard CMOS circuitry necessary for driving microLED displays, as well as the close integration of high performance graphic processing units (GPUs), all of which can be carried out using standard CMOS manufacturing methods. By solving all of the major challenges, licensees gain instant access to a technology platform that is ready for volume production.

“GaN on Silicon is the only technology that makes sense in terms of scalability and performance,” commented Dr Keith Strickland, CTO, Plessey Semiconductor. “It offers better thermal conductivity than Sapphire and higher luminosity than OLED, which is why this technology is widely acknowledged to be the only one that can deliver high resolution, high luminance displays.” ■



Luminosity – No Shadowing

Visit us: Hall 4, Booth B20

light+building



Maximum light distribution, minimum shadowing: WAGO offers a wide product range for all LED applications. International approvals, WAGO’s universal spring pressure connection technology and an ultra-compact footprint open your applications up to worldwide use. Benefit from the new 2065 Series SMD Terminal Blocks’ low profile of just 2.7 mm. Furthermore, WAGO’s all-new 2070 Series Through-Board SMD Terminal Blocks provide back-side wiring of LED modules, minimizing undesired shadowing and simplifying wiring. **We Connect Your Light.**

www.wago.com/lighting

WAGO

A Revolution in Optics from IQ Structures

Brand new revolutionary lenses for luminaires come to the market under the trade name NANOPTIQS. This is a completely new approach to designing and manufacturing lenses using calculated surface nano- and micro-structures.

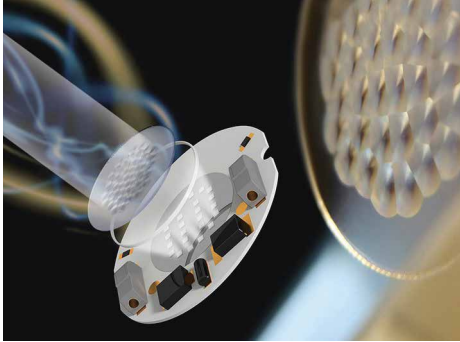

IQ Structures award winning NANOPTIQS lenses may be a game-changer in the LED lighting industry

NANOPTIQS lenses are suitable for all types of luminaires and can be designed for linear lighting, down lights, spotlights, wall wash and other applications. They can also be used in automobiles.

Main Product advantages:

- New design options
- Huge flexibility in functional applications
- Possibility of miniaturization of the luminaires
- A highly productive way of producing optics while saving material, time and energy
- Highly effective

This innovation is brought to the market by IQ Structures, the world leader in computer-generated optical and holographic components.

IQ Structures won an award in the International Design Plus Competition in January 2018 for their "COB-NANOPTIQS flat lens", as well as the IHMA Award for a synthetic computer-generated hologram in November 2017.

The arrival of the revolutionary Nanoptiqs lens meets the prediction of the research and consulting firm Lux Research, which predicted back in 2013 that major changes on the lighting market will be coupled with the LEDs and linked advanced technologies. IQ Structures brings an absolutely new

direction, which will accelerate the lighting market, change the design of light fixtures, output performance, and bring new, previously unimaginable, features.

"NANOPTIQS lenses are currently positioned in front of LED light sources, as is the case with conventional, commercially available lenses. In addition, IQ Structures, together with the company Crytur, is developing the first application of NANOPTIQS used directly on the surface of LED phosphor lamps," says Tomáš Těthal, CEO of IQ Structures. ■

A Complete Light Band Covering ZHAGA-Compatible Lengths

The fourth generation LLE-ADVANCED modules have been expanded to cover ZHAGA-compatible lengths, meaning that very long homogeneous light bands such as might be used in office buildings can also now be implemented with no additional wiring effort.



Tridonic's new, extra long (inset) and small linear modules offer homogeneous linear lighting plus reduced wiring requirements

The new 1120 and 1400 mm module lengths significantly expand the design options available for linear luminaires and panel lights, without increasing the amount of wiring required. The lengths equate to multiples of existing ZHAGA modules, meaning that existing mounting holes can still be used. The smallest of the new modules measures just 70 mm and allows gaps to be filled in the luminaires and shadow effects through the connector to be avoided. The new modules do not differ from the LLE-G4 standard modules in their specifications.

High levels of efficiency, low color tolerance, long lifetime:

With the appropriate driver, the modules achieve efficiency levels of up to 170 lm/W and provide a luminous flux of 650, 1250 and 2000 lm/ft depending on the length. The LED modules are available with different color temperatures in order to cover different usage scenarios: 2,700 K, 3,000 K, 3,500 K, 4,000 K and 5,000 K. The color rendering index Ra > 80 demonstrates the quality of the light, while MacAdam 3 represents low color tolerance levels. The homogeneity of the light is also retained when multiple LLE-G4 modules are arranged in sequence.

Plug-in terminals are available for simple and quick wiring. The manufacturer also offers light covers for these modules for different light distribution options. Once installed the LED modules achieve a lifetime of 50,000 hours. Tridonic provides a 5-year warranty. ■

Bilton Realizes a Fully Encapsulated LED Module

With the new Bilton AIR series, Bilton is presenting innovative and avant-garde ideas that will revolutionize the future of LED lighting. This is achieved through a progressive hybrid solution. The new Bilton LED module series Bilton AIR is a highly flexible silicone hose and, in addition to protection class IP67, guarantees top light quality, effective heat dissipation and is resistant to external influences (UV, salt, chlorine, etc.).

Top features:

- IP protection IP67
- Flexibly shapeable
- Lighting upwards or sideways
- Max. module length up to 5 meters
- Luminous flux up to 1,000 lm/m
- Voltage 24 VDC
- CRI >80
- Light color available in 2,700, 3,200 and 4,000 K

The LED strip light is flexibly shapeable. There are two versions of the Bilton AIR SIDE - with lighting from the side, and the Bilton AIR TOP - with lighting facing up. Both model versions are available in 3 different light colors. Bilton AIR bends in every direction, making the LED strip light perfect for any application - indoors and outdoors!

We are showcasing real innovation at Light and Building 2018. The hybrid solution of the Bilton AIR series realizes the novel design of a completely encapsulated LED strip light. Come along and see the innovations for yourself. We want you to go beyond the limits of feasibility and, under our motto "The Art of Linear Lighting", we want show you inspired and versatile works of lighting art that can be achieved with LED modules.

Tridonic basicDIM Wireless Light Control

Tridonic's compact basicDIM wireless control module paves the way for easy wireless communication with up to 127 luminaires. It is suited primarily to projects that need no direct IP connection and that aim to achieve more lighting comfort in a cost-effective manner and with no additional wiring.



Tridonic's new basicDIM wireless control system consists of a compact control module and a smart button as user interface

The compact control module can be integrated into existing luminaires easily and establishes a mesh communication network automatically. Communication is wireless via Bluetooth 4.0, and therefore requires no DALI wiring. The module is fitted with a configurable 1-10 V and DALI interface along with a switched relay contact, and allows dimming functions and even color temperature controls to be implemented with ease. Groups can also be set up and scenes can be created.

The luminaires can then be controlled via an associated smart button (user interface), or using the corresponding free apps on mobile terminals that run on Android or iOS operating systems. The minimum system requirements are Android 4.4

(KitKat), an iPhone 4S with iOS 5.0 or an iPad 3 with iOS 5.1. Firmware updates can also be installed via the mobile terminals.

Control via a smart button or app:

The pre-configured button for wall mounting works using batteries. It has a clear and manageable control panel with eight buttons that can be used to switch luminaires on and off or for the dimming functions. In addition, light settings can be accessed and color temperatures set.

The luminaires are automatically scanned for and detected using the free apps for Android or iOS. The intuitive interface allows users, for example, to set up groups of luminaires, create different light settings, implement Tunable White settings and define and control dimming levels. The wireless light control supports users with establishing and configuring the lighting control options, enhances lighting comfort and helps save energy. ■

Infineon Introduces BCR430U to Improve Efficiency of LED Strips

Infineon Technologies AG releases BCR430U, a constant current linear LED driver IC. The BCR430U provides industry-leading drop performance for regulating LED current in standalone operation. No external power transistor is needed. Typical applications for the BCR430U include LED strips, architectural LED lighting, LED displays as well as retail, appliance and emergency lighting.

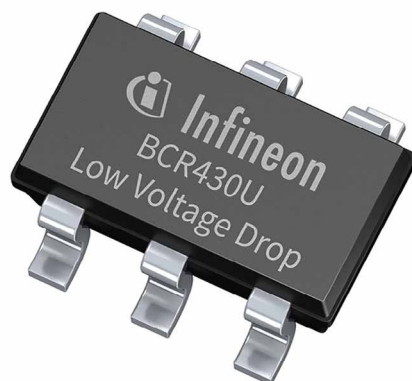

BCR430U improves efficiency for LED strips with an ultra-low voltage drop linear LED driver IC

Round heatsinks for lighting industry

- combined lathe-milling machine for the production of conical heatsink profiles
- thermal analysis of customer-specified cooling concepts
- individual mechanical treatments adapted to your application



For more details please check our website: www.fischerelektronik.de

Fischer Elektronik GmbH & Co. KG

Nottebohmstraße 28 • 58511 Lüdenscheid • GERMANY
 Phone +49 2351 435-0 • Fax +49 2351 45754
 info@fischerelektronik.de

**We exhibit:
 „light + building“ in Frankfurt
 18. - 23. 3. 2018
 hall 4, stand E91**

The voltage drop at the integrated driver IC can go down to 135 mV at 50 mA. This improves overall efficiency and provides the voltage headroom required to compensate for LED forward voltage tolerances and variances in the supply voltage. Thus, more flexibility in the lighting design is possible. With the BRCU430U, additional LEDs can be added to lighting designs without changing the supply voltage.

The LED driver current ranges between 5 mA and 100 mA, and can be easily adjusted via high ohmic resistor on a dedicated pin. The supply voltage ranges between 6 V and 42 V. For safe and reliable operation and to extend the LED lifetime, a smart over-temperature controlling circuit reduces the LED current when the junction temperature is very high. ■

Constant-Current LED Drivers in Low-Profile DFN Package

In response to growing demand for smaller LED lighting installations that also provide high efficiency and ultra-low EMI, Diodes Incorporated has extended its popular BCR420U and BCR421U families of linear LED drivers to include the BCR420UFD and BCR421UFD devices in the ultra-low profile DFN2020 package, making them well-suited for 12 V and 24 V LED edge-lighting applications.

The primary benefits of LED lighting, namely longer lifetime and higher efficiencies, means there is growing demand for more varied and less intrusive solutions. This includes fittings that emit light from the edges as opposed to vertically. In order to meet this demand, manufacturers are looking for solutions that support a thinner overall profile. At just 0.6 mm in height, the DFN2020 package is uniquely suited to edge lighting.

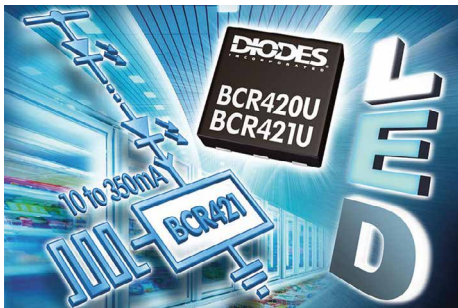

Diodes' new constant-current LED drivers in a low-profile DFN package are especially suitable for edge lighting

Like other members of the BCR4xxU series, the new devices can deliver an adjustable constant current between 10 mA and 200 mA (BCR420UFD) or 350 mA (BCR421UFD) with $\pm 10\%$ tolerance, which in the case of the BCR421UFD can be controlled using a PWM signal of up to 25 kHz and a duty cycle of 1% to provide LED dimming functionality. Both devices include a negative temperature coefficient, which lowers the LED driver current as the internal temperature rises, thereby protecting and extending the lifetime of the LEDs. In addition, the linear topology used is based on an NPN emitter-follower with emitter resistor, which means the devices exhibit virtually no EMI, making them well-suited for sensitive applications such as medical lighting.

With a wide operating voltage range of between 1.4 V and 40 V and total power dissipation of up to 1.7 W, the devices can be used to drive longer strings of LEDs while still providing sufficient protection from transients in a 24 V system. Designed as monolithic solutions, the devices integrate transistors, diodes and resistors in a single package measuring just 0.6 mm high. This is much thinner than the standard SOT26 package, allowing engineers, architects and lighting designers to develop LED fittings with a much lower overall profile, for a wider range of applications. Edge lighting is now being specified in areas such as emergency, mood or decorative lighting, but is equally

applicable in medical, industrial and commercial environments.

The BCR420UFD and BCR421UFD linear constant current regulators for LED lighting are available in production volumes now, priced at 0.11 USD each in 3K piece quantities. ■

Digi International - New Smart Edge IoT Modules and Modems

Digi International®, a leading global provider of Internet of Things (IoT) connectivity products and services, announced the availability of the Digi® XBee3™ series of next-generation RF modules and cellular modems. Introducing a new micro form factor option capable of supporting greater IoT innovation at the network edge, Digi XBee3 series extends its modular approach to IoT connectivity, enabling the integration of new functions as needs arise and regional requirements change. Included in its micro size, Digi XBee3 also offers MicroPython programmability and dual-mode radios that provide wireless design flexibility and enable easily added functionality for innovative IoT solutions that can be more quickly developed, prototyped and mass-produced.



Digi XBee3 includes new micro form factors: RF modules and cellular modems feature programmability and flexible architecture, providing modular agility for advanced IoT edge connectivity

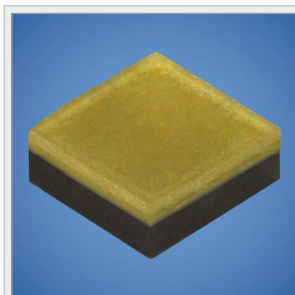

Cree® XLamp® XD16 LED First to Surpass the 280 lm/mm² Lumen Density Mark

The XLamp XD16 LED delivers a lumen density of more than 280 lm/mm², the highest level achieved by a commercial lighting-class LED. The ceramic-based XD16 LED uses the proven XQ footprint and combines breakthrough lumen density, low optical cross-talk, unsurpassed thermal contact and ease of system manufacturing to enable new designs for lighting such as color-tuning, street, portable & industrial.

For more details, please visit Cree's XLamp® XD16 LED webpage



→ Hall 4.0 • Booth B40

light+building

peters
Coating Innovations
for Electronics



Management of LED Colour Temperature by Jetset Solution

Photo: peters@peters.de

| CCT shift | initial state | Jetset Solution |
|---|---|--|
| <ul style="list-style-type: none"> • uncoated • potted • CCT 6000 K • 110 lux | <ul style="list-style-type: none"> • uncoated • non-potted • CCT 4000 K • 160 lux | <ul style="list-style-type: none"> • nano-coated • potted with ELPECAST • CCT 4000 K • 110 lux |

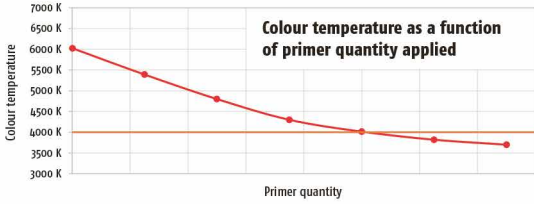

Colour temperature as a function of primer quantity applied

Lackwerke Peters GmbH & Co. KG
Hooghe Weg 13, 47906 Kempen, Germany

E-Mail: peters@peters.de
Phone: +49 2152 2009-0

www.peters.de

→ Hall 4.0 • Booth B40

light+building

ELPEPCB®
peters



Easy thermal management with screen-printable thermal transfer pastes

- highly thermally conductive systems
- effectively lower operating heat
- flexible layouts and layer thicknesses are applied by screen printing on the unassembled pcb within pcb production
- when printing into heat vias, the thermal interface is enlarged and thermal transfer/dissipation improved
- thermal transfer resistances are reduced
- cost-effective alternative to conventional heatsinks or heat-conductive foils

Heatsink Paste (HSP)

- for optimum heat transfer and heat dissipation

Thermal Interface Paste (TIP)

- elastic, thus enabling an optimum connection with metallic cooling elements or housings
- thermo-mechanical decoupling even with permanent temperature changes

λ in W/m·K

| Copper | Alu | HSP | TIP | Air |
|--------|------|-----|------|-------|
| ~400 | ~200 | ~2 | ~1.9 | ~0.02 |

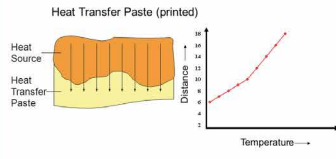

Lackwerke Peters GmbH & Co. KG
Hooghe Weg 13, 47906 Kempen, Germany

E-Mail: peters@peters.de
Phone: +49 2152 2009-0

www.peters.de

peters
Coating Innovations
for Electronics

Digi XBee3 Advanced Capabilities:

- Easy over-the-air (OTA) changes to devices in the field for bug fixes and new features
- Dynamically reconfigurable, based upon situation
- Easily establish business rules to aggregate, store, transform and filter data via MicroPython programming capability
- Create alerts and alarms for priority data and device health
- Built-in support for advanced I/O including I²C, SPI, to drive modern sensors and actuators
- Provide control logic for devices that require a microcontroller, without electronics redesign
- With Digi Remote Manager®, enables better bandwidth management via prioritization/ transmission of actionable information
- Dynamic changes to behavior as requested from cloud platforms such as AWS and Azure (e.g., enabling real-time decisions based on local conditions)
- Continue to operate during communications outages by dynamically executed logic that is not cloud-dependent

Micro, SMT and Through-hole Form Factors:

At one-third the size of the original Digi XBee RF module, the Digi XBee3 micro form factor (13x19 mm) is one of the industry's smallest MicroPython-programmable modules capable of providing RF connectivity for short range and Low Power Wide Area Network (LPWAN) applications.

Also available in the existing Digi XBee SMT and through-hole form factors, the Digi XBee3 micro, when installed on interposer boards, automatically provides all the benefits inherent in the industry's smallest RF module capable of supporting the development of truly innovative, smart IoT solutions. Additionally, the through-hole form factor is ideal as a validation and migration platform for those requiring the advanced capabilities and features necessary to speed development, prototyping, or early-production phase. Digi XBee3 Cellular is available in its original, classic through-hole form factor.

Micro Module With Big Features:

With its reduced size, weight and power consumption, Digi XBee3 series is ideal for compact and battery-powered applications. Digi XBee3 delivers multiple levels of programmability including dual-mode radios, MicroPython for both business rule and application logic, and the tools to manage it all. In addition to edge programmability, it offers a low-power microcontroller capable of delivering intelligence at the network edge, and the ability to switch between a variety of protocols without changing the device. With the built-in Digi TrustFence® security framework, all Digi XBee3 products offer U.FL, Pad, or Chip antenna options.

Design Flexibility:

Digi XBee3 series will be initially available in both RF (ZigBee 3.0, IEEE 802.15.4) and cellular options (Cellular Cat-1). Over the next several months, Digi XBee3 will be software-upgradeable to Bluetooth LE and will also be available in additional RF protocols (DigiMesh® and Wi-Fi) and two cellular modems (Cellular LTE-M and Cellular NB-IoT).

Development Kit Availability:

The Digi XBee3 ZigBee Mesh Kit is available for evaluation and testing. The kit includes three Digi XBee3 modules along with three Digi XBee Grove Development Boards allowing customers to build a ZigBee mesh network right out of the box.

“With the development of the Digi XBee3, we’ve combined advanced features and flexibility in a micro form factor to offer the very first ‘Smart Edge’ IoT module,” said Scott Nelson, vice president of product for Digi. “With intelligence moving to the edge of IoT networks, the market needs hardware that is very capable, very adaptable, secure and extendable. What we’ve provided in Digi XBee3 is a module that can deliver solutions capable of aggregating and analyzing data where it is captured on a distributed network, and apply specific business rules and application logic – essentially the next generation of IoT applications.” ■

Inventronics Expands Family of Low-Power, Compact LED Drivers

The EUC Family of constant-current LED drivers is ideal for lower power luminaires that may be subject to environment and space constrained challenges. They are available in popular fixed output currents and offer increased flexibility through isolated 0-10 V dimming and a compact shape that allows them to be installed in space constrained luminaires.



Inventronics' new EUC driver family is ideal for applications that may be subject to environment and space constrained challenges

The EUC family is expanding to include 30 W models whose compact metal housing is ideal for flood, wall packs, and architectural decorative lighting applications, as well as low-power street lighting. The new 30 W series complements the existing 26 W, 35 W, 40 W and 60 W models. They operate over a 90-305 Vac input range while providing

exceptional thermal performance and a total harmonic distortion (THD) under 10%.

The EUC-30SxxxDTM/DVM provides a higher input surge protection with 4kV line-to-line and 6kV line-to-earth and incorporates input under voltage (IUVP) and input over voltage (IOVP) protection for installations where the power may be unstable. DTM versions are IP66 rated and suitable for built-in use while DVM versions are IP67 rated and suitable for independent use.

The new series offers 3 models that deliver 350, 500 and 700 mA of output current. They are highly reliable and have a calculated lifetime to be at least 88,000 hours when operating at 80% load with a case temperature of 75°C.

The EUC-030SxxxDTM/DVM models are approved to UL, FCC, CE, KS, TUV, CB and CCC standards. Production quantities are available now. ■

OEM Systems Group's New Offer for the Digitalization of Light

Mega-trends such as digitalization or the Internet of Things will fundamentally change lighting technology in coming years. Solutions are in demand that bring together intelligent control, connectivity, flexibility and the possibility to individualize. Today, the new LED electronic control gear units from the OEM Systems Group in the ZITARES wiz series already point the way towards this networked future. The LED ECGs represent a high-performance unit together with the correspondingly new EXELIQO software.



The LED ECG ZITARES wiz and the EXELIQO software form a single unit – connectivity and intelligent control for greater flexibility

An open interface provides maximum flexibility:

ZITARES wiz offers a decisive advantage with the digital Z-COM interface. The open protocol (API) enables luminaire producers to custom-connect

their communication modules and sensors to their specific needs.

The intelligence is decentralized – each luminaire becomes an intelligent node within the building network.

The high speed of bidirectional communication between the ECG and connected components provides high levels of lighting convenience – completely without noticeable delay times as often experienced in larger DALI applications. In addition to the Z-COM interface, the electronic control gear units also feature a standardized DALI interface.

ECG and software as a high-performance unit:

The intelligent ECG forms a high-performance unit together with the also newly developed EXELIQO application software. Desired configurations, ECG functions and settings are individually implemented with the software. These include precise setting of output current, temperature-dependent control of output current, compensation of LED degradation (CLO) and measuring of the ECG temperature. The complete system scores with its open architecture, so that users can already today efficiently and flexibly implement future-safe solutions such as networked systems or simple data exchange.

Four Main Focus Applications:

- **Wireless control:** Communication modules connected via Bluetooth for example to the Z-COM interface enable ZITARES wiz to regulate the light without need of additional control lines. This cuts installation effort significantly. Supplementary central controllers are superfluous, enabling simple scalability
- **Light management:** The open Z-COM interface means easy integration of sensors, e.g. for presence detection and the daylight-dependent light control of luminaires
- **Programming of parameters:** Parameters and functions are flexibly adaptable and modifiable both during luminaire production and subsequently. For example, adaption of the LED operating current or to ensure constant lumen output (CLO) over the complete life time
- **Monitoring & maintenance:** Individual ECG operating data can be recorded. This provides completely new possibilities for predictive maintenance and the measurement of energy consumption

The first generation of the ZITARES wiz electronic control gear unit – the series is being consistently expanded in the coming months – is accompanied by matched system components. These include the Bluetooth module based on reliable technology from CASAMBI and a daylight- and presence sensor for direct connection to the electronic control gear unit. In addition to these system components available from OEM Systems Group, luminaire producers can also integrate other components and technologies (e.g. ZigBee, EnOcean etc.) – matching these to the Z-COM interface is possible thanks to the open source platform. ■

MechaTronix Unveils CoolStar® Series of Designer LED Coolers

“Because looks do count”, that was the basic idea when MechaTronix started to develop their next platform of spot light, down light and shop light coolers. Inspiration for the design was searched in natural elements which express the feeling of cool or cold.



With its new CoolStar® Series, MechaTronix provides heat sinks that, based on the “form follows function principle”, satisfy the increasing aesthetic demands - “because looks do count”

The result is an impressive series of new LED coolers with a stunning high end look. Koen Vangorp, CEO of MechaTronix “Although the first priority of a LED cooler remains a maximal cooling capacity in a limited volume, also the looks of the product are of great importance. Even recessed downlights and shop lights, where the majority of the volume is hidden in the ceiling, first need to be sold to the customer. And during that decision phase the LED cooler takes a big part of the looks for its account.”

The CoolStar® family covers the whole range of cooling capacity from 1000 lumen all the way up to 6000 lumen, which positions them as well in the spot light developments as in the down light and shop light luminaires. The modularity in LED engines which can be mounted either directly or with a LED holder (ref. BJB, TE Connectivity, Bender Wirth) is respected on each design. On top of that some practical features have been added, like two closed wire pockets at the sides which allow to guide the wiring from the LED engine to the back side outside the visible field. Besides the black anodized versions which are commonly used, MechaTronix has also opted this time for a “pure white” electroplating as an option, underlining the

EPISTAR

Standing on the shoulder of giant

SEE FURTHER

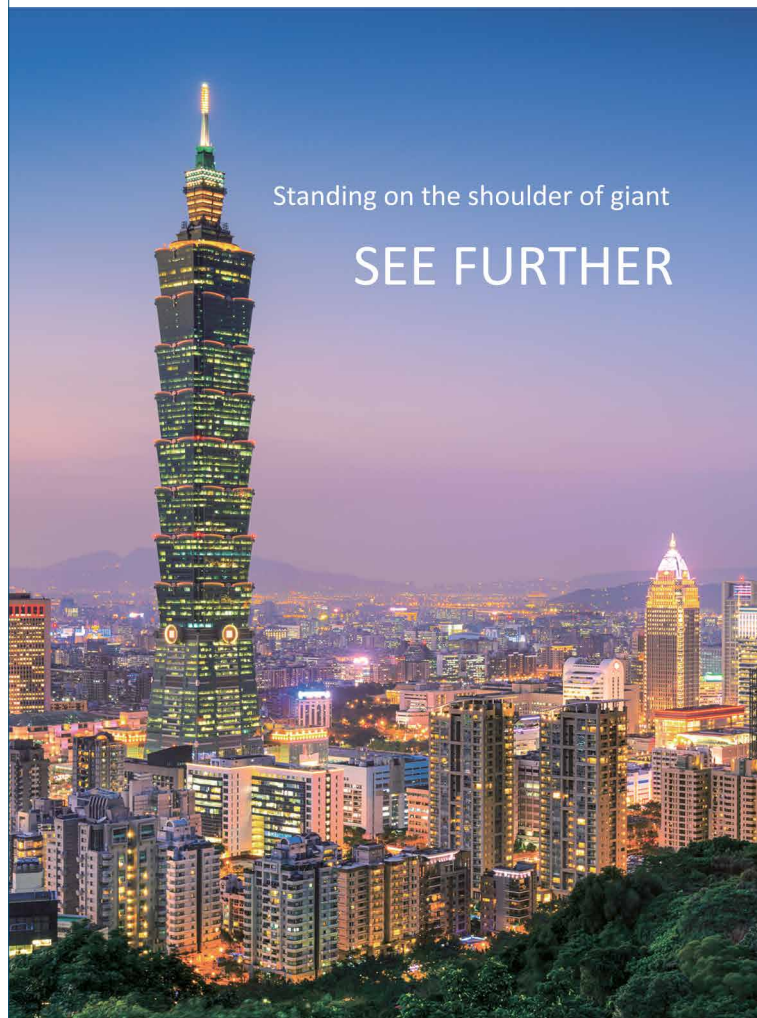

Learn more about our
Co-activation Service Model

Epistar Corporation
21, Li-hsin Rd., Hsinchu Science Park,
Hsinchu 300, Taiwan
T : +886 3-567-8000 F : +886 3-579-0801
www.epistar.com E : sales@epistar.com



Website Facebook

high-end looks and blending with the mostly white looks of both the LED engines and the LED holders.

Koen Vangorp "The biggest challenge was, for sure, to reach the uncompromised cooling performance the CoolStar® stands for without losing the looks we had in mind. It took us over six months and an endless amount of CDF thermal simulations to get to perfection. Certainly in the smallest diameters a very big step forward was made in cooling performance with a gain of over 35% compared to similar diameters on the market. Also this time we played on safe, patenting the whole series according the Hague System, which gives us design protection in all major parts of the world." ■

Fischer Elektronik - Phase Change Thermal Conductive Material

Company Fischer Elektronik GmbH & Co. KG extends their extensive product portfolio of thermal contact materials by new phase change thermal conductive materials which provide an alternative to the conventional thermal conductive pastes.



Fischer Elektronik's new FSF 15P and FSF 20P phase change material is available as sheet or roll material and can be customized

The new material types combine the advantages of high thermal performance together with the reliability of phase change materials and with a simple application on the surfaces to be contacted.

The thermal conductive material with the designation FSF 15 P and FSF 20 P is solid in its delivered condition and begins to flow at a phase change temperature between 52°C and 48°C each. Hereby, microscopically small unevenness between heat source and a heat sink, for example, will be compensated.

During the moistening, air escapes out of the area of the boundary layer which leads to a significant reduction of the thermal impedance and simultaneously to an optimal heat transfer resistance. The material thicknesses vary from 0,114 mm up to 0,2 mm whereby the customers can select the particular material thickness contact surfaces depending on the unevenness and roughness.

The thermal conductivity of the new designs is within the scope of 1,5 up to 2 W/mK. For a simple handling (easier installation) in the application both types have a one-sided natural adhesive layer. The basic material of the article FSF 15 P is available as sheet or roll material whereas the FSF 20 P is only available as sheet material in the dimension 300x400 mm. Special cuts and contours of the phase change materials will be performed according to customized drawing specifications by means of latest processing machines. ■

TE Connectivity - New Lumawise Drive LED Holder Development Kit

TE Connectivity (TE) has introduced a development kit for its Lumawise Drive LED Holder Type Z50, enabling luminaire designers to purchase a single unit for desktop testing, product evaluation and luminaire prototyping. Each kit contains an LED holder, a cable assembly and a thermal interface material.



Luminaire designers can now test and evaluate the Lumawise Drive LED Holder Type Z50 with development kit from TE Connectivity

The Lumawise Drive LED holder Type Z50, launched last September, has a built-in low-profile DC/DC driver that brings integrated functionality and flicker-free illumination to the company's successful range of Zhaga-inspired Z50 LED holders for COB LED for spot and track lighting, without any change to outside dimensions.

"Since we launched the Type Z50 LED holder less than six months ago, response from the market has been very encouraging," says Jonathan Catchpole, systems architect & business development at TE. "At TE we aim to make engineers job's easier and accelerate the development process for technologists. The new development kit makes it easier for luminaire designers to appreciate its advantages and work out how best to integrate it into their new products."

Designed for 48 VDC input, the Lumawise Drive LED holder Type Z50 works with a wide range of readily available constant voltage power supplies, making it possible to power multiple fixtures off a single power supply. Designers can also remove driver boxes from spot and track lighting, creating a more aesthetically pleasing and lower-cost solution. Further functionality can be added to the holder with an optional 0-10 V dimmer.

The Lumawise Drive LED Holder Type Z50 provides thermal and electrical connection to four different COB sizes – 16x19 mm, 19x19 mm, 20x24 mm and 24x24 mm – and has four different current outputs: 350, 500, 700, and 1050 mA. ■

Adels-Contact Introduces LEDtrack – LCS 75 – SMDblank

On 18 March it will be that time again: The world's leading trade fair for lighting and building technology, Light + Building 2018, with more than 2,600 exhibitors, will open its doors. Along with their well-known solutions, Adels-Contact will present three innovations that impress with their quality and reliable functionality.

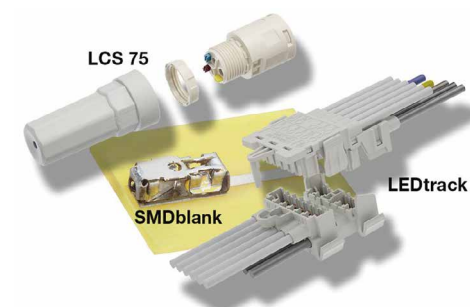

At Light + Building 2018, Adels-Contact will launch the LCS 75 – smart connection for IP66 luminaires, the LEDtrack – one single system for all functions in a lighting strip, and the SMDblank – the smallest SMD connector with two connection options

LEDtrack – the Optimum Connection of Lighting Strip Systems

With the LEDtrack, Adels-Contact offers for the first time a special solution for lighting strip systems for use in large-scale industrial buildings, such as production halls, warehouses or supermarkets. The complete system is attractive, due to its diversity. Apart from the mains supply, it allows for the integration of DALI, emergency lighting and sensors. Depending on the customers' needs, it is possible to provide the LEDtrack with 5, 7, 9 or 11 poles. Its small form allows manufacturers to design extremely flat and narrow lighting strips. Installation without tools, as well as free positioning, are convincing arguments when installing on site.

LCS 75 – Intelligent Connection Solutions for IP66 Water-Proof Luminaires

The LCS 75 presents an advanced development of our patented LCS 45. No matter whether for underground car parks, trade fair halls or industrial buildings: Luminaires up to IP code 66 are connected

in next to no time. The manufacturer supplies the luminaire with a pre-assembled LCS 75 connector. There is no longer a need to open the luminaire, as the electrician connects it from the outside. Installation time and errors in electrical installation are minimized while time and costs are saved.

SMDblank – Extremely Small SMD Connectors without Mouldings

The SMDblank extends the SMD connector product portfolio by a moulding-free variant. The innovative concept offers two versions in one. Connection can be made horizontally with solid or flexible conductors. Alternatively, it is possible to use the vertical feed-through version for solid conductors – depending on the customer's individual needs. With a height of only 2.5 mm the SMDblank is a very small connector type that has nevertheless been optimized for the nozzle removal from the tape-on-reel packaging. ■

GRE Alpha Introduces EnOcean Wireless Dimming Module

GRE Alpha announced the release of its cutting-edge ENO-DIM dimming module with integrated EnOcean technology. The spring-loaded terminal simplifies installation and is compatible with any EnOcean-enabled wireless switch. With the ready to install dimming module, it's just plug and play. The ENO-DIM is available in three regional frequency versions: 902 MHz in North America, 928 MHz in Japan, and 868 MHz in Europe and China.



The ENO-DIM combines EnOcean's self-powering technology with GRE Alpha's dimming technology

InterLumi

The lighting trade fair can be your local partner
Panama

Light it up
your market in Latin
America & the Caribbean!

11-13 July, 2018

ATLAPA Convention Center, Panama

www.inter-lumi.com



The single-channel ENO-DIM module hooks up to any constant voltage LED driver, including an existing DC power distribution panel or at any point in an existing lighting circuit. The ENO-DIM module operates at a maximum 5 Amp capacity and can support up to 30 EnOcean wireless energy-harvesting devices. The module adheres to UL8750 standards and is IP20-rated.

This dimming module makes it possible to easily retrofit existing wired lighting control systems with simple to install EnOcean-enabled wireless switches. These switches utilize the energy created by the touch of a button to send a wireless signal to the ENO-DIM module. There are no batteries or wires required, and switches can be mounted anywhere.

ENO-DIM applications include architectural lighting, effect and contour lighting, general commercial illumination, warehouses, signage, strip lighting and more. The ENO-DIM dimming module is one of the most innovative products in the industry. By combining GRE Alpha's dimming technology with EnOcean's self-powered sensors and switches, GRE Alpha is paving the way for industrial lighting systems that are sustainable and energy-efficient. ■

Gigahertz-Optik Introduces the CSS-45 Remote Spectral Detector

The CSS-45 detector incorporates a powerful microprocessor which performs not only data acquisition but also all necessary lighting calculations. Both USB 2.0 and RS 485 interfaces are standard, enabling the flexible configuration of single and multi-detector based systems. An optional software development kit supports integration into third party application software.



Gigahertz-Optik CSS-45 detector head, side view (left) and top view (right)

With its wide spectral range from 360 nm to 830 nm the CSS-45 is ideal, for example, as a high accuracy photometric and colorimetric detector (according to CIE S023). The precision diffuser provides excellent cosine correction ($f_2 \leq 1.5\%$). The optical bandwidth correction feature (CIE 214) further improves the quality of the spectral measurement data. Manual and auto gain settings enable a wide measurement from 1 lx to 350,000 lx for illuminance and color measurements.

Additional functions of the CSS-45:

The embedded intelligence of the CSS-45 enables the direct output of a comprehensive range of radiometric, photometric and colorimetric parameters based on the measured spectral data.

Additionally, specialist functions are incorporated for particular applications fields including:

- Horticultural lighting – PAR measurement Photosynthetic Photon Flux Density (PPFD) in $\mu\text{mol}/\text{m}^2\text{s}$
- Human Centric Lighting – melanopic irradiance and illuminance, melanopic daylight equivalent illuminance
- Phototherapy – total irradiance for bilirubin, Ebi, in mW/cm^2 (IEC 60601-2-50) as well as average spectral irradiance in $\mu\text{W}/\text{cm}^2/\text{nm}$ (American Academy of Pediatrics)

Options for the CSS-45:

- Software development kit for integration of the device in the user's own software

The robust housing and its connectors are splash proof, and therefore suitable for use in industrial applications. A variant with protective glass dome in front of the diffuser is available. A special feature of the detector is its remote-controlled shutter, which allows a dark level measurement to be made at any time. ■

LaserVision-LED Inspection System with Reel-to-reel Option

Prüftechnik Schneider & Koch Ingenieurgesellschaft mbH is further expanding the LED inspection range for their LaserVision LED. The Bremen-based AOI specialist is presenting a reel-to-reel option to the professional public for the first time at the Light & Building trade fair, which opens

its doors in Frankfurt am Main in March. The AOI and LED testing of rolled LED ribbons is thus possible.

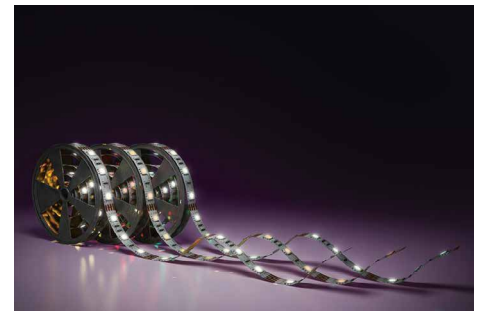

Automated flexible LED ribbon testing is no simple task, but Schneider & Koch did the job

With the further development, Schneider & Koch is clearly pursuing its own corporate strategy of aligning existing inspection systems even more closely with customer requirements. "When we talk about the testing of LED products, we've also got to think about how rolled LED ribbons can be tested. That's why we've decided to continue developing the existing LaserVision-LED system for testing these luminants. Technically, this demands some changes inside of the machine," explains Ronald Block, managing partner at Schneider & Koch.

Position monitoring is especially challenging, because the LED ribbons are very flexible. The monitoring is done during handling, whereby contacting is also ensured. This contacting occurs in the edge area and presupposes repeat contacting. Because the user often cut LED ribbons to the desired size, the roll material often contains recurring units. That's why repeat contacting is possible. The ribbons can be up to 600 mm wide. No roll length is defined. That way, different LED ribbons with differently placed LEDs can also be tested on a single roll. But separate ribbons on different rolls can also be simultaneously inspected.

The power supply's ability to supply the entire roll, or several rolls in parallel if needed, must be guaranteed while the rolls are being inspected. The maximum current is not needed, because a test can also succeed at low power. It is important, because of intense heat generation in such cases, that LED rolls are not permanently energized. The heat generation can be controlled with a targeted current feed that can be switched via a matrix.

Making LED
Lighting Solutions
Simple™

We Accelerate Time to Revenue by Providing

- ▶ The Most Comprehensive System-Level Product Portfolio
- ▶ Solid-State Lighting Expertise
- ▶ Design Support Services
- ▶ Global Supply Chain and Business Solutions

light+building
18.-23.3.2018 Frankfurt am Main

Visit us at our stand!
We look forward to seeing you
Hall 4.1, Stand G10

 **FUTURE**
Lighting Solutions

www.FutureLightingSolutions.com

2018 LIGHTFAIR International
May 6 – 10, 2018
McCormick Place, Chicago, IL USA
Booth #837

A vacuum table fixes the LED ribbons during the inspection process. The test head is mounted on an X/Y axis and travels to the individual inspection points. Complete testing of the assemblies is possible in the process. This includes AOI testing as well as testing of the LEDs regarding their light parameters. There are two different testing approaches for LED tests. The cycle-time-optimized approach employs the camera used for testing during AOI. Testing can certainly also be conducted via an integrated spectrometer. However, this is not fundamentally necessary, because the camera often delivers adequate results. The spectrometer can be drawn upon for more exact measurements. Because a very slow spectrometer measuring, it's unsuitable for use in mass production.

"Both testing processes are combined in our system, whereby LaserVision LED unites the advantages of both: rapid testing with the camera and exact measurement with the spectrometer", explains Block. The unique feature is the matching. A board can be measured with the spectrometer and then brought into agreement with the camera system. Testing is done at the individual-LED level. LED lights can be tested completely as final products and also in different production levels. An additional camera is optionally available for testing ultra-bright LEDs.

The LED ribbons are rewound onto a roll at the conclusion of testing. However, subsequent cutting to a single roll ready for sale can also be done. "LaserVision LED acquires another unique feature with this additional option for testing LED ribbons. ■

Selteka Introduces Skylighter Luminaires for Biodynamic HCL

On 18 March at the Light + Building 2018 show in Frankfurt, Selteka will present Biodynamic, Enhanced Human Centric lighting luminaires Skylighter with BLOWN light mixing technology – amazing light spectrum and color rendition, automatic light intensity and color profiling which supports natural human biorhythm. ■



Selteka's new developed luminaire Skylighter (installation Suspended) from family SL-B6-2765-1 even alone and without external controller can provide automatic circadian lighting with color rendition Ra>95, R9>90!

BLOWN Light Technology

Smart LED Lighting System: Biodynamic BLOWN light technology is developed by the Lithuanian company Selteka in collaboration with scientists from Vilnius University and Kaunas University of Technology.

Hence, it is based on know-how, which comes from 50 years of experience in the electronics business and is also supported by the theoretical knowledge from academia.

The BLOWN brand reflects the biological needs, which are essential for every human. The created system, which is not only energy-efficient, but also adopts the natural biorhythm, is maybe even more important than practical visual demands. This is a new step in enhancing people's living and working environments.

Visual Function: The super smart six different light channel mixing technology is one tool to enhance "Zeitgeber's". Designed to improve the physiological processes of adapting to prolonged presence under artificial lighting. BLOWN technology, provides light management to keep the color rendering index Ra>95 and R9>90 in all CCT range 2700-6500 K.

Automatically supports organic day light color temperature and intensity rhythm, responds to external lighting dynamics and the people in the room.

Emotional and Biological Effects:

Extensive Melanopic Lux range and Flicker free in a range of up to 800 Hz. Comfortable smart technology that enables people working/living for long periods of time without natural light to experience a light source that allows them to live closer to their circadian rhythm. ■

Phoseon UV-C LED - Performance Boost

Phoseon Technology announces that utilizing its patented SLM™ technology and proprietary thermal management system achieves a breakthrough level of deep-UV irradiance targeted at disinfection and decontamination Life Science applications. Phoseon is the first to develop a 275 nm UV LED disinfection system that surpasses 5 W/cm², significantly higher than the 0.3 W/cm² levels reached by other technologies in the market.



Phoseon Technology's huge step forward surpassing 5 W/cm² irradiance power opens new applications and opportunities in disinfection

"This milestone development enables us to produce a level of irradiance that provides scientists, researchers and equipment manufacturers the capability to think and act beyond traditional methodologies," says Jay Pasquantonio, Senior Product Manager at Phoseon. "For the past 30 years, low irradiance has limited the efficacy of UV-C solutions. Phoseon has provided a new path based on high power that allows our customers to build high-performance; long-lasting products that reduce research times, lower operating costs and provide improved disinfection capabilities."

Phoseon's SLM technology offers unmatched levels of deep UV irradiance, which enable significant process improvements in the field of Life Sciences, including faster analysis and operations, and increased capabilities for disinfection and decontamination applications that require low wavelengths.

High irradiance, combined with appropriate wavelengths, targets specific bonds in DNA, RNA and proteins within microorganisms and biomolecules. This allows shorter inactivation times while improving overall efficacy of the disinfection. The high absolute irradiance of these new solutions enable high-throughput processes in pharmaceutical, sequencing, air handling and manufacturing facilities. ■

Fraunhofer IIS IoT-Bus: High Security - Not Just for Lighting

The Fraunhofer Institute for Integrated Circuits IIS is developing the IoT-Bus with IPv6 support and integrated security concept. It is a communication bus based on EIA/RS-485 and the IEEE 802.15.4 standard, which enables a secure and reliable data transmission of measured values and control commands and connectivity to the Internet of Things. The IoT-Bus forms a cross-media communication protocol and unites the two worlds of WPAN and fieldbuses without complex protocol conversion. The novel technology IoT-Bus is developed as part of the SEEDs project.

IP Communication on the Internet of Things

In the context of the increasing cross-linking and digitization in the fields of Industry 4.0, energy management and facility management, IP capability within

the terminal node is becoming more and more important. The Internet of Things (IoT) has specific requirements on data rate, range, reliability, cost, flexibility, interoperability, and in certain cases, also data security. Consistency of the protocols and seamless data-flow across different domains is essential to enable the IoT. Internet connectivity holds security risks in manners of data manipulation and cyber-attacks.



While the Fraunhofer IIS IoT bus is not especially dedicated to lighting controls, it offers huge opportunities to control LED luminaires: Bridging distances up to 500 m with up to 1 MBit/s

Data Manipulation Secure Communication on the Internet of Energy

In the area of energy management a simple, but secure and reliable interconnection of local resources, producers and consumers through the decentralization of power generation is becoming increasingly necessary. Especially in cloud-based applications, secure IP-based communication is required. It allows access via IP-capable control devices such as smartphones, tablets or PCs for visualization or control purposes. Fraunhofer IIS is developing a communication bus that allows a direct connection of system components on the Internet besides the local communication. The IoT-Bus reliable transmission at higher data rates and longer distances is possible as what is offered by conventional fieldbuses and wireless solutions. Through automatic address assignment and allocation of the installation, the process is facilitated. If a confidential or manipulation secure data connection is necessary, the IoT-Bus provides standardized crypto-logical procedures for authentication and encryption.

ELECTROLUBE
THE SOLUTIONS PEOPLE

A leading light in engineering improved LED performance

We don't just strive to exceed expectations, we innovate to make the best of industry, perform better.

The LED market is the perfect example of our capabilities in action. LEDs are considerably more efficient than traditional lighting forms, but they do still produce some heat, which without thermal management will have an adverse effect on both the efficiency and operational lifetime of the LED.

From bonding and non-bonding thermal interface materials, to thermally conductive resins and protective conformal coatings, our solutions offer the ultimate level of protection and heat dissipation for your LED application.

With an expansive product range and a strong emphasis on research and collaboration, we provide a complete electro-chemical solution to the world's leading LED manufacturers.

Isn't it time you discovered how Electrolube can serve you?

+44 (0)1530 419600

www.electrolube.com



Electronic & General
Purpose Cleaning

Conformal
Coatings

Encapsulation
Resins

Thermal Management
Solutions

Contact
Lubricants

Maintenance
& Service Aids

Functionality

The IoT-Bus is a fieldbus with IPv6 support and an integrated security concept. It combines the advantages of native internet protocol support with the advantages of a fieldbus in terms of range, reliability, robustness and low latency.

This technology is based on an adaptation of the communication standard IEEE 802.15.4, which is the de facto standard for Wireless Personal Area Networks (WPAN) and sensor networks, thus allowing the use of these wireline logs. The concept envisages a communication on 2- or 4-wire lines. The 4-wire solution also enables the power supply for communication of the communication nodes via the bus.

The use and adaptation of IEEE Std. 802.15.4 the IoT-Bus allows a medium-border communication channel. For 802.15.4 nodes are realized without breaking protocol a comprehensive communication network with both wired IoT-Bus and wireless IEEE Std. Using a special access method allows the IoT-Bus a real-time communication. The serial interface uses the standard EIA-485 (RS-485), but can also be adapted to other interfaces.

The system consists of up to three different physical communication paths, the actual IoT-Bus (1) based on the IEEE Std 802.15.4 with customized bus access method defined by IEEE 802.15.4 radio nodes (2) can be extended and a connection of the internet (3) on the IoT-Bus router.

Easy and Flexible Integration of Standard Protocols

The IoT-Bus uses 6LoWPAN and thus realizes the IPv6 capability of the terminal nodes. This allows that all protocols which are based on TCP/IP can be used conceptually. The end nodes can be, among other things, sensors, actuators or generally »things« in the context »Internet of Things«.

They can simply communicate with the internet or be connected to the cloud.

Additionally, the IoT-Bus offers by its data container concept, the possibility of a so-called »tunneling« of messages and protocols, such as CAN message. This functionality can be used for range extension of limited itself fieldbuses. The tunneling of CAN messages is currently taking place in the SEEDs project.

Contrary to wireless sensor networks and WPAN solutions, the IoT-Bus scores with higher reliability, robustness and greater range for point-to-point connections. Compared to common building automation communication technologies, it also offers real-time communication and additionally IP capability and IT security for the IoT-Bus.

Unique Characteristics of the Communication Bus:

- Connection with the wired and wireless world
- IPv6-based fieldbus with cross-media communication
- Ideal combination of data rate and range for IoT applications
- Data rate up to 1 Mbit / s with a range of up to 500 meters
- Real-time capability
- By deterministic bus access method
- IPv6 capability of the end nodes
- IoT capability by supporting Internet standards (6LoWPAN, UDP, IPv6, etc.)
- Consistency of the protocols
- Direct compatibility with IEEE 802.15.4 based radio
- Enables the transmission of standardized application protocols
- MQTT, MQTT-S, OPC-UA, CoAP
- Integrated Security concept
- Use of standardized encryption methods (TLS, D-TLS)
- No additional gateway required
- Fast packet routing without protocol conversion

Applications:

- Communication between local resources, producers, consumers, even over long distances
- Optimization of energy flow and energy management
- Smart Building Automation
- Communication for in-house Grid Control (DC and AC)
- Direct connection of system components to the Internet of Energy
- Integration of smart meters (for local communication)
- Connection of system components at the IoT

Possible Fields of Application

CAN Range Extender

With its data container concept it is possible to transfer various protocols. This allows the IoT-Bus to be used as a range extender. This function is already available for the CAN protocol. A packet filter can be used to select which messages are to be transferred from one CAN domain to another

IoT-Bus for Industry 4.0

The IoT-Bus allows interdependent production facilities to exchange information. Existing systems can be retrofitted to IP-capable to be used for industrial applications

Building Automation

Devices in the building automation system, such as blinds, radiators, air-conditioning and lighting can be easily connected with the IoT-Bus in larger complexes over long distances. The communication for automated and manual control is thus made possible

Secure Lighting Control

The IoT-Bus is suitable for individual lighting control in modern buildings – e.g. "Light As A Service" and "Human Centric Lighting"

With its IP capability and real-time capability, the IoT-Bus is suitable for a wide range of applications within Industry 4.0, building automation and energy management. ■



Proof Your Blue Light Hazard Risk: Instrument Systems' Stray Light Corrected CAS 140D

With the CAS 140D Instrument Systems is the first to offer an array spectrometer with unique stray light correction that can reliably assess the blue light hazard from light sources within the prescribed limiting values. The optimized spectrograph block and the unique stray light correction matrix, integrated in the calibration procedure, ensure an up to now unachieved precision in the determination of blue light hazard with an array spectrometer.

For further product information, please visit www.instrumentsystems.com



Supercomputers Aid Discovery of New, Inexpensive Material to Make LEDs with Excellent Color Quality

A team led by engineers at the University of California San Diego has used data mining and computational tools to discover a new phosphor material for white LEDs that is inexpensive and easy to make. Researchers built prototype white LED light bulbs using the new phosphor. The prototypes exhibited better color quality than many commercial LEDs currently on the market.

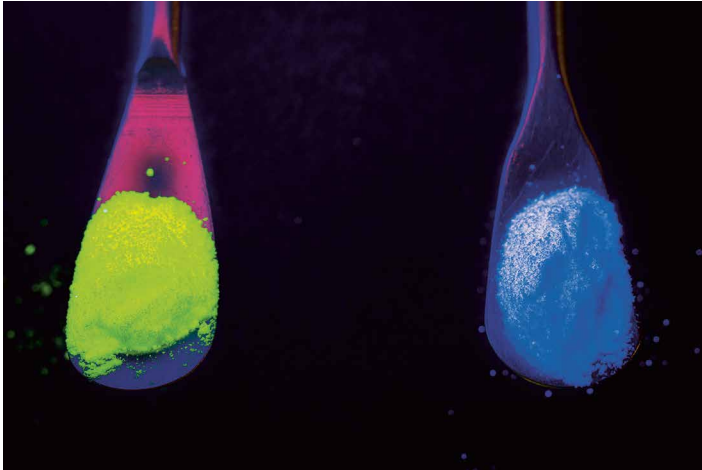

Under UV light, the phosphor emits either green-yellow or blue light depending on the chemical activator mixed in (Photo by David Baillot/ UC San Diego Jacobs School of Engineering)

Phosphors, which are substances that emit light, are one of the key ingredients to make white LEDs. They are crystalline powders that absorb energy from blue or near-UV light and emit light in the visible spectrum. The combination of the different colored light creates white light.

The phosphors used in many commercial white LEDs have several disadvantages, however. Many are made of rare-earth elements, which are expensive, and some are difficult to manufacture. They also produce LEDs with poor color quality.

Researchers at UC San Diego and Chonnam National University in Korea discovered and developed a new phosphor that avoids these issues. It is made mostly of earth-abundant elements (strontium, lithium, aluminum and oxygen); it can be made using industrial methods; and it produces LEDs that render colors more vividly and accurately.

The new phosphor, $\text{Sr}_2\text{LiAlO}_4$ or simply SLAO, was discovered using a systematic, high-throughput computational approach developed in the lab of Shyue Ping Ong, a nanoengineering professor at the UC San Diego Jacobs School of Engineering and lead principal investigator of the study. Ong's team used supercomputers to predict SLAO, which is the first known material made of the elements strontium, lithium, aluminum and oxygen. Calculations also predicted this material would be stable and perform well as an LED phosphor. For example, it was predicted to absorb light in the near-UV and blue region and have high photoluminescence, which is the material's ability to emit light when excited by a higher energy light source.

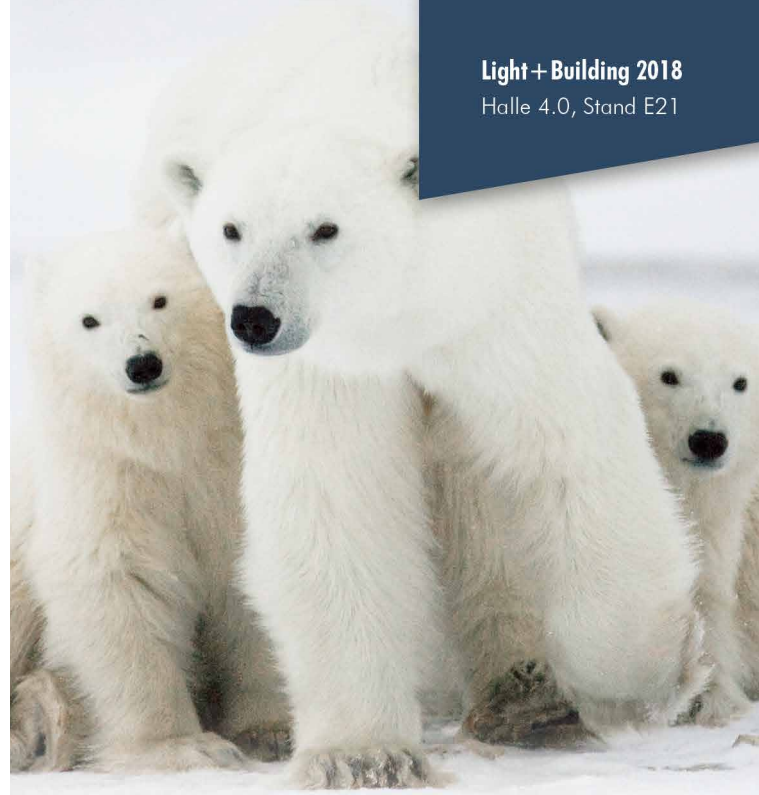

Invisible but strong



SMD-Klemmen – passende Lösungen für den Anschluss von LED-Modulen

- **SMDblank** – horizontaler und vertikaler Anschluss ohne Isolierkörper
- **SMDflat 345** – mit 3,45 mm die niedrigste Bauhöhe im Rastermaß 4,0
- **SMDflat 545** – mit 2,5 mm² das größte Anschlussvermögen im Rastermaß 6,0

ADELS
contact

Der sichere Kontakt weltweit
www.adels-contact.de

Researchers in the lab of Joanna McKittrick, a materials science professor at the Jacobs School of Engineering, then figured out the recipe needed to make the new phosphor. They also confirmed the phosphor's predicted light absorption and emission properties in the lab.

A team led by materials science professor Won Bin Im at Chonnam National University in Korea optimized the phosphor recipe for industrial manufacturing and built white LED prototypes with the new phosphor. They evaluated the LEDs using the Color Rendering Index (CRI), a scale that rates from 0 to 100 how accurate colors appear under a light source. Many commercial LEDs have CRI values at around 80. LEDs made with the new phosphor yielded CRI values greater than 90.

The computational quest for a new material:

Thanks to the computational approach developed by Ong's team, discovery of the phosphor took just three months - a short time frame compared to the years of trial-and-error experiments it typically takes to discover a new material.

"Calculations are quick, scalable and cheap. Using computers, we can rapidly screen thousands of materials and predict candidates for new materials that have not yet been discovered," Ong said.

Ong, who leads the Materials Virtual Lab and is a faculty member in the Sustainable Power and Energy Center at UC San Diego, uses a combination of high-throughput calculations and machine learning to discover next-generation materials for energy applications, including batteries, fuel cells and LEDs. The calculations were performed using the

National Science Foundation's Extreme Science and Engineering Discovery Environment at the San Diego Supercomputer Center.

In this study, Ong's team first compiled a list of the most frequently occurring elements in known phosphor materials. To the researchers' surprise, they found that there are no known materials containing a combination of strontium, lithium, aluminum and oxygen, which are four common phosphor elements. Using a data mining algorithm, they created new phosphor candidates containing these elements and performed a series of first-principles calculations to predict which would perform well as a phosphor. Out of 918 candidates, SLAO emerged as the leading material. It was predicted to be stable and exhibit excellent photoluminescence properties.

"It's not only remarkable that we were able to predict a new phosphor compound, but one that's stable and can actually be synthesized in the lab," said Zhenbin Wang, a nanoengineering Ph.D. candidate in Ong's research group and co-first author of the study.

The phosphor's main limitation is its less than ideal quantum efficiency - how efficiently it converts incoming light to light of a different color - of about 32 percent. However, researchers note that it retains more than 88 percent of its emission at typical LED operating temperatures. In commercial LEDs, there's usually a tradeoff with color quality, Ong noted. "But we want the best of both worlds. We have achieved excellent color quality. Now we are working on optimizing the material to improve quantum efficiency," Ong said.

Acknowledgments:

The press release was published from the UCSD at http://jacobsschool.ucsd.edu/news/news_releases/release.sfe?id=2476

Researchers published the new phosphor on February 19 in the journal *Joule*.

Paper title: "Mining Unexplored Chemistries for Phosphors for High-Color-Quality White-Light-Emitting Diodes." Authors of the study are Zhenbin Wang*, Jungmin Ha*, Joanna McKittrick and Shyue Ping Ong at UC San Diego; and Yoon Hwa Kim* and Won Bin Im at Chonnam National University, Republic of Korea.

*These authors contributed equally to this work

This work was supported by the National Science Foundation, Ceramics Program (grant 1411192). Computational resources were provided by the Triton Shared Computing Cluster at UC San Diego, the National Energy Research Scientific Computing Centre, and the Extreme Science and Engineering Discovery Environment supported by the National Science Foundation (grant ACI-1053575). This work was also supported by the Basic Science Research Program through the National Research Foundation of Korea, which is funded by the Ministry of Science and ICT (NRF-2017R1A2B3011967). ■



LEDiL STRADA-2X2MX Series Revised to Provide Expanded Support for Ecosystem Partner Components

STRADA-2X2MX is LEDiL's popular 90x90 mm standardized modular optic series compatible with up to 7070 size LED packages. Particularly suited for street lighting, the series offers a wide variety of beams for applications requiring high lumen output. The new revisions provide better ingress protection under high temperatures and expanded support for many ecosystem partner components.

For more information please visit: www.ledil.com/2x2mx-8-pr



Light is the efficiency booster LED-based industrial lighting

Special ambient conditions in production and logistics facilities call for lighting components with long lifetimes, a wide temperature range, a high intensity of illumination and a high quality of light for safe and effective working. In order to cut costs while providing high-quality light, many luminaire manufacturers today rely on robust LED components and intelligent control technology from OSRAM. Our future-proof lighting systems reduce the power consumption as well as the maintenance effort. This pays off. More information at www.osram.com/industry-lighting-systems



Light is OSRAM

OSRAM

CIE Research Addressing Color Quality of Light Sources Related to Perception and Preference

With the development of new lighting technologies, LED light sources are increasingly used for general lighting. These light sources are creating diversity in light spectra and imposing new challenges in assessing their color quality. Youngshin Kwak, Director CIE Division 1, describes how several CIE Research Groups are joining forces, working on this topic to find new standard indices to adequately specify color quality.

The Color Rendering Index (CRI), in particular the general color rendering index, Ra, defined by CIE Publication 133, is widely used for assessing the color rendering characteristics of light sources. It was first published in 1965 after fluorescent lamps had emerged, and was last improved in 1974. Color science has progressed considerably since then, and recognized improvements are available for many of the components used in the CRI. Nevertheless, the CRI has served fairly well for most light sources and has been well accepted over the past 40 years, though revision of the CRI was occasionally investigated (CIE Publication 135/2-1999). There are many government regulations and voluntary programs to promote energy efficient lighting products. These regulations and specifications not only specify minimum luminous efficacy (lm/W) but also minimum values of the general color rendering index, Ra, and ranges of white light chromaticity to ensure good color quality as well as energy efficiency, as both are inter-related.

Limitations of the CRI

Limitations of the CRI have been recently addressed, especially for solid-state light sources, whereby the Ra values do not always correlate well with visual evaluation by general users. This mismatch arises, first, from inaccuracies of the CRI in its intended role as a color fidelity index; and second, from perception-related color quality effects beyond color fidelity. The first is the inaccuracy of color appearance evaluation arising from the original 1974 CRI formulae and the small number of color test samples used in the CRI calculation. The second is a limitation of the CRI due to the fact that it is simply a color fidelity metric; that is, the CRI values are based on the color appearance of objects compared to their appearance under the defined reference illuminant. Color quality characteristics other than color fidelity are also important, and different analysis methods are required to assess them in the context of lighting applications, tasks, and user preferences. This is especially important when samples undergo chroma enhancements arising from the source's narrowband spectral features. In some experiments, subjects generally preferred illumination that slightly enhanced the color saturation of the illuminated objects they

viewed, even though the chosen light sources had lower Ra values (Figure 1). Due to the nature of the CRI (or a color fidelity index), many preferred lights with increased gamut are excluded when a minimum requirement is given, e.g. $Ra \geq 80$ or $Ra \geq 90$.

Improvement Measures

It was determined by the CIE that, for both aspects, better color quality characterization methods are needed to measure and specify white-light sources, and the work was divided into two corresponding tasks: (1) to develop a scientifically accurate color fidelity index, assigned to TC 1-90, and (2) to develop one or more perception-related color quality measures beyond fidelity, assigned to TC 1-91 for initial work.

In 2017, TC 1-90 published a Technical Report 'CIE 224:2017 CIE 2017 Color Fidelity Index for accurate scientific use' describing a general color fidelity index, Rf, as a scientifically accurate measure of color fidelity with respect to a reference illuminant, although there still remain some technical issues for further research. This color fidelity index, based on the fidelity

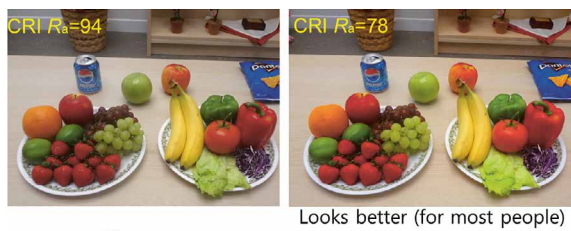

Figure 1:
CRI measures color fidelity to a reference illuminant, different from color preference

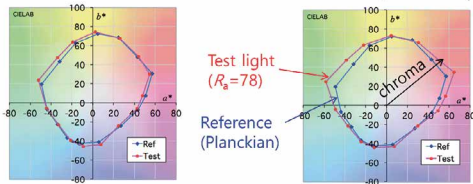
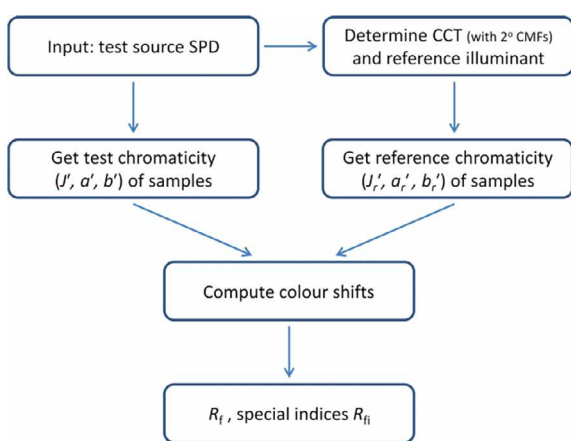

Figure 2:
Calculation flow for the color fidelity index



index of the Illuminating Engineering Society of North America, defined in TM-30-15, addresses aspects for only the first part of the limitations of the CRI – it does not address the need for perception-related color quality measure(s) beyond fidelity (Figure 2). However, it does correct several previously reported inaccuracies of the CRI as a color fidelity measure. The important improvements of this measure, relative to the CRI, are the update of the color difference calculation, in particular the object color space, and the incorporation of 99 test-color samples which provide a more uniform distribution of slope and curvature values as a function of wavelength and which have color appearance values that are more widely and uniformly distributed in the three dimensions of a uniform color space. To assess the important aspects of the color qualities of light sources other than color fidelity, in particular, those related to color preference, CIE TC 1-91 is developing a Technical Report on this subject, which will be the groundwork for developing color preference metric(s).

The CIE encourages further research on these two aspects of color quality, which may be useful inputs to the current or future work of CIE. The overall objective of the research is to develop indices for color quality other than color fidelity, especially those related to general color preference, which is the perceived or subjective judgement of color rendering (e.g. for naturalness). It is known that chroma saturation (gamut area) or shift of chromaticity from the Planckian locus has strong effects on perceived color rendering or preference, but such effects are not measured with a color fidelity index, and some preferred lights are penalized by a color fidelity index such as the general color rendering index, R_a . It seems there are general preferences in chroma saturation and chromaticity, but research data for such perception effects are still very limited. Data are lacking for various conditions, e.g. different hues, different objects viewed, different parameters (naturalness, preference), and long-term effects, in different applications, demographics (race, age, sex), or for

different regions of the world. Much more research data are needed to be able to develop an index for perception-based color quality. A whiteness index also needs to be investigated as a quality index to assess white lights, in order to resolve the problems associated with objects that contain optical brightening agents. Therefore, future research is required.

Key Research Questions

- How can “preference” (or a model for color quality perception) be clearly defined and assessed for the intended end use? It may also be affected by users’ long term visual experience. How can it be addressed?
- Are the individual variations in such preferences too large to define general preference?
- Can the preference for chroma saturation and white light chromaticity be substantially different in different regions (or race of people) in the world?
- What are the relevant parameters to measure the subjective aspects of color quality and the whiteness index?
- How to design an index to measure the whiteness perception of a light source? How to apply the surface whiteness indices for lighting application?

Conclusions

Based on the research proposed here, CIE will define standard indices that can be used with a color fidelity index, all of which will allow specifying or evaluating overall color quality of lighting products. The CIE also recommends that important lighting metrics such as the Color Rendering Index require formal international agreement. New metrics introduced at the regional level could cause confusion in the global lighting market. The process of developing CIE recommendations by scientific consensus often requires considerable time. However, since the CIE is expediting the researches on color quality, new CIE color quality metrics will be introduced in the near future. ■

Tech-Talks BREGENZ - Fred Maxik, Founder & CTO, Lighting Science Group



Fred Maxik

Mr. Maxik is one of the world's foremost experts in Solid State Lighting. He is the founder and CTO of Lighting Science Group.

He has over 25 years of experience in innovating environmentally friendly technologies. He is the principle inventor of more than 140 patents and has published several papers on light and its interaction with biological systems and has received several awards for his work.

LED light in combination with advanced controls, and here especially IoT capabilities, opened several new options in lighting. In this context, the term Human Centric Lighting, and more recently, the term Biologically Active Light have become trendy. Fred Maxik, founder and CTO of the Lighting Science Group, who held the keynote speech at LpS 2017, recognized these opportunities in a very early stage when most other manufacturers were still struggling with the challenges of the new technology. In the interview he explains what his perception of light is and its importance in our lives. He gives insights into his philosophy and ideas on which criteria artificial lighting has to fulfill in order to live up to the promising terms „Human Centric Lighting“ and „Biologically Active Light“.

LED professional: Thank you for joining us for this interview. We attended your Keynote yesterday and we were very impressed with the talk, especially the fantastic pictures. One of the main points of your keynote was the relationship between light and humans. For me, one aspect that stuck out was how you explained that light is as it is - and humans, plants and animals all developed in a way where the light was right for them. Could you explain that again for our readers?

Fred Maxik: Certainly. There is, I think, at this point, a general consensus that we are and have evolved as diurnal species. We're used to the light cycle of the sunlight and the evening cycle of the stars and moon. And we did not just uniquely develop our bodies' processes. They were adopted – in fact – infused as different bacteria, as different cells, as different things combined to create life as we see it today on

the planet. And all these already had some photosensitivity, some diurnal period associated with them. When you take a look at single cell algae today, we see a diurnal period. When we look at what composes the human body there are a lot of the same ingredients. And the sun and daylight and all light have an influence, therefore, on our biological processes. So that is where we establish that this is the evolutionary path we took. This is why we are using photosensitivity in many ways – not just our circadian rhythms – but even the way we digest our food. The way bugs grow in our stomach. The way we see and the way we act. We've even had some seasonal effects that we've seen in various cultures that were seen up to a hundred years ago before electric light was introduced to their environments. We've created eternal summer now with our lighting systems and we all live in this eternal summer.

LED professional: So can we say that natural light is the standard and artificial light should be as close as possible to natural light?

Fred Maxik: Maybe. I think there are two components to light that we need to be conscious of. We cannot deliver to a human being inside a building the dose of light that the sun delivers. We are not capable of the intensity of it, nor should we be. However, we can look to and create a portion of what is natural. But first we must understand what portion of what is natural has the biological effects we're interested in. And what portion of what is natural does not? And therefore we can reengineer a spectrum of light with that knowledge to mimic what we want to replicate in natural light.

LED professional: From biology, especially from entomology, we know that you can trigger a reaction easier by hyper optimal

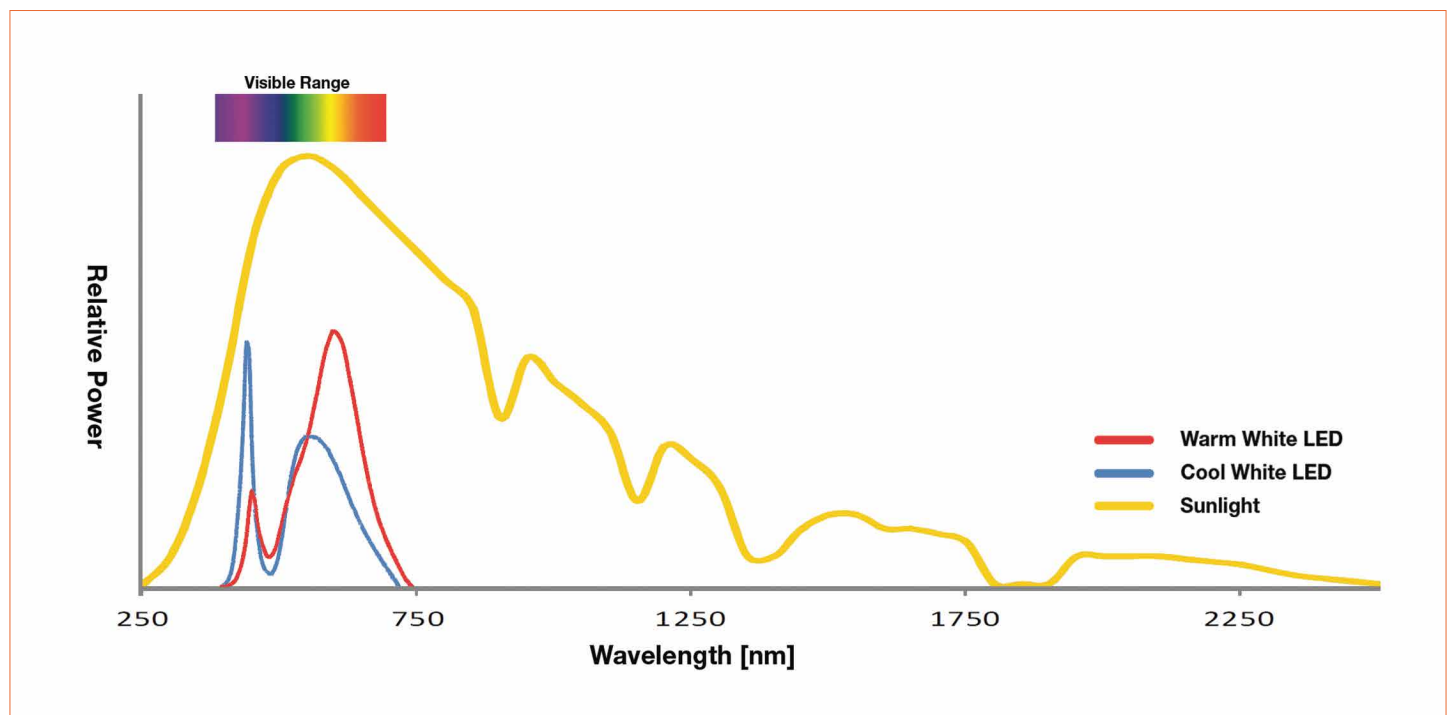

All life on earth, including humans, have evolved under sunlight and are used to the light cycle and spectrum of sunlight. The visible part is just a small fraction of this spectrum. Most artificial light sources, including LEDs, don't even roughly reproduce the visible spectrum of the sun

conditions than you could with the natural part. Do you think we should try to achieve this or do you think it might be stressful for people and we should stay within the limits given to us by nature?

Fred Maxik: My personal belief is that I think it should be considered. It should be studied and it should be understood as best we can. And then with that knowledge and that data we can make judgments as to what we should and shouldn't do. In the very first instance, I think we should try to do no harm.

The other thing I would say, and we talk about this quite frequently, is natural light versus artificial light. I don't know that a photon knows if the light is coming from the sun or a light bulb. I have a problem with natural and artificial. Light is light. How it is produced can be discussed. I would probably alter that and say that natural light is the spectrum of light and the intensity of light we evolve from. We evolve from the sun and the stars and then there is "other" light. The other light is introduced by man initiated actions. And I would add that that spectrum is not the same and in no cases is it yet the same.

LED professional: Yesterday there were a lot of lectures dealing with human centric lighting. We have been talking about this topic and its influence on human biology for at least fifteen years now.

But everyone who talked about it in their lecture acted as if it were completely new. Don't we have enough information right now to start with human centric lighting? I ask because if you looked at Jan Denneman's timeline, yesterday, human centric lighting starts far beyond the year 2020. Don't we have the technology or we don't have the knowledge to focus on it right now?

Fred Maxik: Maybe we don't have a receptive audience. I think that we have enough knowledge today to begin implementing some aspects of human centric – or lighting that affects humans – particularly in the areas of sleep. I think that's the most compelling argument we have today. We have good laboratory studies by first class universities that show elements of our light; particularly that peak at around 475 – 485 nanometers, can disturb a healthful sleep. So I think that we can begin today on developing light sources that are less interruptive to

what we consider our natural way to go to sleep, our natural hormone secretions at night, our natural REM sleep cycles and not delaying the onset of all those. I think that's stable, sound science today.

There is sound science around how light can wake us up in the morning, how we can take that alerting dose. How we can work forward towards mitigating some of the present activities like seasonal affective disorder. You're right: those things have been around for a while.

Now we understand the pathways from the ganglion receptors in our eyes that communicate into the suprachiasmatic nucleus in the brain and I think we understand how the circadian clock works. There's solid ground there. And I don't know if we have a receptive audience in the consumer base yet. And that's going to be a challenge. I actually agree with you. It may be several more years before the audience is educated enough to understand what we're talking about. But as an industry we can discuss it and promote it.

Secondly, though, as we look at the light centricity of humans and other things, there are going to be

A serious conversation between the two lighting professionals, Fred Maxik and Guenther Sejkora



other things we continue to discover. There is some work being done on light and chemotherapy. There haven't been any studies yet but it's very promising. But it will probably take years, maybe decades, to sort out. There's light and aging and brain health. Particularly dementia and Alzheimer's as we look at how the brain clears various waste matter. This is very, very promising work going forward. As an industry, we should look at what this means - we call it the human centricity of light. That's a wonderful opportunity for the industry and it's a wonderful opportunity to do some real good with it - and there are a dozen categories like this.

LED professional: There are a few companies already using this knowledge. For example, the Lighting Science Group is working on the interaction of light and humans. Could you give us a short introduction to the Lighting Science Group?

Fred Maxik: Sure. I established Lighting Science Group eighteen years ago. It was established only to look into solid-state light. We had no other interest in other sources. It wasn't only about energy - initially it was about how we take light and how we might manipulate that spectrum of light to create different effects. And as we learned more about it - about fourteen years ago - we started working with NASA. We worked with the astronaut corps and began to understand what the challenges were in space. They started talking to us about how every 90 minutes having a space station circling the Earth and all the lighting cues for the astronauts are thrown off. So very quickly, they start losing team coherence because their clocks are essentially free running - out of sync. So we started to develop lighting systems for them to test which were beginning to be installed a decade later on the space stations.

We developed technologies from there. We made test beds that we

sent to universities around the world to work on this lighting type science that we aptly named ourselves after. And then we started getting into other areas like the mosquito - one of the deadliest animals on the planet. What do we know about the spectrum that would let us create lights that are less attractive to them? What would let us create lights that are more attractive to them so that we can move them into trap areas? What can we do about other animals?

We continued down that path for a long time and now we're looking at health and sanitation. We're looking at how we clean our air with light and how we clean our water with light. How we develop a built-in environment that's in a healthful place - not only to work, but also to live. Now we've split the company into two parts: One concentrating on general end products - doing some millions of dollars a month in general lighting products, and the other looking on science. Trying to figure out 'What are the next steps?' 'What are the products that flow from there?' and 'What is the continued research that we want to do to advance into those areas?'

LED professional: It would be nice to know more about light and humans, but it seems there is not enough money for research. How do you finance your scientific work?

Fred Maxik: Today we are privately financed. We do work with a private Equity Company in New York that funds our efforts. They have been a wonderful partner for us. We started with them almost eight years ago and they have financed our activities. They are equally curious about where this will go to and are firm believers that we are building value by discovering new pathways and have allowed us a lot of latitude in how we continue to move this forward. But we also partner with universities to create extensibility in the studies we do. We partner with medical schools and overseas universities as well. We try to make ourselves as extensible as possible.

We've brought in interns from all over the world to help us discover things in-house as well. I think we're frugal in our testing but I think we've got enough latitude to be able to put enough stakes in the ground so that we can have a study here that might take five to ten years to mature and we have a study that might mature in six months. It's a good mix.

LED professional: How big is Lighting Science Group and how many people deal with science and research and how many deal with the products?

Fred Maxik: There are about twelve to fifteen that work directly on the R&D side and of those, probably about three or four are university professors who come in and consult with us for periods of time. In terms of the company itself: The company is not very large. It's probably about \$70 to \$75 million a year right now - so fairly small for a lighting company but I think we're on the right track and if we are, we'll see a very nice organic growth shortly.

LED professional: If we look at your products on the Internet, the main product seems to be the replacement bulb with a very specific spectrum. Do you have other products as well?

Fred Maxik: We do everything from highly dynamic 16-channel color mixing test devices for universities all the way to a single fixed spectrum. So we have what I think is the full gambit of what is possible. We're working on hyper spectral sources that will be controllable in a number of ways. We're also looking at potentially hyper spectral sources even in a bulb that will be adjustable. I think those are soon to come.

LED professional: If someone decides to buy a product that should have certain spectrum effects, do you get feedback from those people about how it works?

Fred Maxik: In a lot of cases we do.

Closer to sunlight - in comparison to conventional phosphor converted white LEDs (b), the latest generation of LEDs almost perfectly matches the visible spectrum of the sun (a)

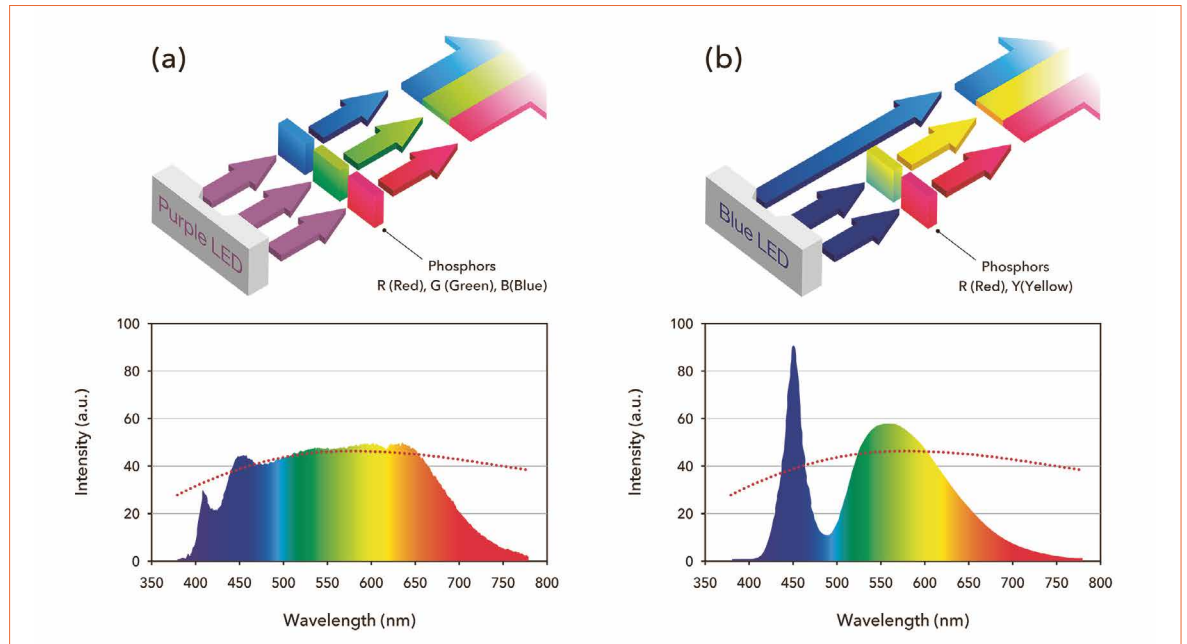

We get a lot of direct feedback and for the most part it's very positive. People from around the world actually reach out to us to ask where they can buy products. We get calls from all around the world and the feedback is generally very positive. And just to repeat a little anecdote I used in my speech yesterday; there's a value the lighting industry leaves on the table because we don't understand the customer we're serving yet. In North America and the United States – the sleeping aid industry is larger than the entire lighting industry. If we can displace a small fraction of that industry using warm light instead of sleeping aids, we could double the size of the light industry. So when you think about what lighting can be, instead of having the “others” come in and try to take our business where our profitability is. Instead of sharing our data with the CISCO's of the world, and whoever else might want to market our data – what if we decided, instead, to take a little piece of their business? I think there is the opportunity like never before for the industry to grow in a very unique way.

LED professional: That is an interesting comparison between the lighting and sleeping aid industries. Normally, if you buy a sleeping aid – there is a package leaflet that tells you exactly how to use it. Do you

also have instructions about how to use light?

Fred Maxik: Yes! We are beginning to develop this idea – and it doesn't need to be prescriptive – but in the sense of the studies we've done, we know that if we give the wrong light 90 minutes before sleep, we delay the onset of sleep, then we delay the onset of REM sleep, then we delay the onset of melatonin secretion. We've seen this in studies. So we have the knowledge today to start building those leaflets.

LED professional: I talked to Jan Dennemann earlier and we agreed that the consumer needs to be educated. If the end-user is educated and wants the better light then it would put pressure on the companies that install the lights to provide the higher quality light. But how can we do this?

Fred Maxik: Actually, I do have an idea. I think there is a natural first customer. The natural first customer for all of this is hospitality. Hospitality pays 500 Euros for curtains and 100 Euros for a pillow; a thousand Euros for a bed and then tells its customers that they can offer them a better night's sleep. But then they pay 1 Euro for the light bulb they put next to the bed! If we can educate the hospitality sector and show them that if they paid 15 Euros for

the light bulb, they would give their customer a 15% better sleep, and tell them why they're doing it – then everybody who stays in the hotel, comes away thinking about it. So because the hospitality sector is in the business of selling sleep, I think they would help us. There's a natural synergy there. So that would probably be my first target.

LED professional: If we go back to the technology and what your company is doing for lamps or systems: How do you shape this spectrum? Do you do your own material research to find the right phosphors? Or do you work with partners?

Fred Maxik: It's a combination. We do our own material research. We do our own material research with converters. We do our own material research with filters. We don't do research on dye – we source our dye. And we mix all those technologies together. We have a very senior chemist in the group that was involved in LEDs very early on in the industry. We have two physicists, and we spend a lot of time optically modeling our sources and what we're getting and how we're getting it. We don't make our own phosphors today. If we want them, we have them made or we source them ultimately for production.

But we do experiment both in the quantum dot space or in the filter space to see how precise we can get to, what we think is our ideal spectrum output.

LED professional: Another question about technology: If you need light in your bedroom, for example, I think it could be a luminaire or a lamp with a fixed spectrum. But if you need one for your office, I think it has to be dynamic because you stay in the office the whole day and as natural light changes during the day, I think the indoor light should change as well. So, do you also work in the controls field or do you adopt controls that are already known or control systems that are already on the market?

Fred Maxik: Again the answer is both. But I'm a bit cynical about standard controls and standard smart-type applications. I'm actually spending my time creating and looking at machine learning systems. Whereas the fixture or the fitting or the light source understands where it is in the world and how it is being utilized without being told what to do. So – maybe a slight dithering of the spectrum through the day, light cloud cover would do. But not necessarily big transitions for sunrise and sunsets. I think those are more for show than for real effect. So – I don't know. I think the jury's still out on whether we can use a fixed spectrum in the office. I think that some compromised spectrum that has enough enriched blue, enough of a high CRI and can be reduced to a fairly low glare level that mimics a natural light without having to worry about having to shift it to anything else other than that. I think the slight dithering would reduce the eyestrains and the other things associated with that. But I think that jury's out. I think that we don't understand that, yet.

LED professional: That partially answers my next question: If you use standard systems who makes sure that the programs in these systems are right? You can have the best light source, you can have the best controls, but if it's programmed wrong it won't do its job.

Fred Maxik: This is where, again I think that we, as an industry, have an amazing ability to gather data that will enhance our value or we decide to give it away to someone else. It is known in building systems – it is known in the architectural space - these patterns of utilization of space can be used to create – and analytics can be applied to that – to understand how space is used and

whether it's being used effectively or whether it's being used happily. And I think, as we start gathering this data and mixing it with the lighting recipes we are applying, we, as a machine become much smarter as to what we do and how we learn and how our lights learn. I think there may be some very simple metrics that we can apply today into a lighting system or a lighting fixture, that allows to understand how the people are utilizing that light and that space. And I think that's an area worthy of lots of exploration in the future. That's again – a high value path. We're looking at office space now – open office space – shared desks. There will be ways of identifying user patterns. There will be ways of identifying utilization patterns that I think lighting is uniquely positioned to explore. And that's an area that I think is well worth for the lighting industry to pursue.

LED professional: At the controls and driver level, it's not just the spectrum itself, you said you could imagine that people are more alert when they are relaxed but we still have an issue with many drivers today and that is flicker. There are big discussions going on about what is acceptable and what isn't. What is your opinion?

Fred Maxik: There are many people looking at that today. We have folks on staff that are looking at it and exploring it, and also people on some of the committees that are investigating. This is where it goes back to what's natural. Natural light doesn't flicker. It shifts, but it doesn't flicker. I think the closer we can mimic that in a light source, the more interesting it becomes and the less obtrusive it becomes to human health. So I'm a firm believer that we should minimize it but I'm not on top of the specification associated with doing that today. I'm more interested in how we morph color without having sophisticated controls.

LED professional: Back to the biological effects. There was a discussion yesterday about the blue ray. Professor Haim talked about the damage that shifting the day/night cycle – which can actually be done using blue light – might do, or does. So what do you think about this? In my opinion the SCHEER report only looks at the damage that blue light can do to the eyes. But what do you think about the influence of blue or short wavelength light on the whole body.

Fred Maxik: High energy – short wavelength light can certainly harm things. We know by

studying UV how much harm short wavelength light can do. So there's no reason, until we hit a certain threshold that we shouldn't expect there's the potential for short wavelength damage. But we go outside and sit in the sun and get a monstrously high dose of blue light and we've done that for years. In fact, since we've been here. So I think that we can overstate the case. And I'm concerned that we push it now. I think that blue light at the wrong time of day is more of a concern, like a late night dose of blue light. Our visual system is very quick to respond but has a very short latency. It responds in seconds but there is no latency to that effect residually is seen. This blue system – these ganglion receptors that we have – having much longer latency of their effect – and once they are triggered and once they start signaling, the latency of their effect can go on for one or two hours, maybe even three hours. And that's what we should be cautious about. It's not that it's doing physical harm to the eye, although it can if you stare at it for long enough, but it's throwing off these other physiological systems. To me, that's where the danger lies. It's not just something we pass and we see lights going on. But once the ganglion receptors are triggered, the latency of that interrupts our sleep. I think there will be studies in the future that will show that what we've done to ourselves is at least partially responsible for causing hormonal cancers and a contributor to early onset dementia. And these are the areas that, I think, it's going to take ten and twenty year studies to get to. But I think we will link these together in the next ten to twenty years.

LED professional: That is a very interesting and thought-provoking statement to close on! Thank you very much for your time.

Fred Maxik: Thank you. ■

Lifetime- and Economic Efficiency Simulation of LED Luminaires in Dymola/Modelica

The lifetime of an LED system is usually specified by the LM-80 report using the TM-21 method. Unfortunately, this value is solely valid for one specific application. Sebastian Haemmerle and Thomas Schmitt from the University of Applied Sciences Vorarlberg developed a new open-source Modelica library for dynamic simulation of LEDs: The DynaLed library. The aim of the work was to evaluate the lifetime and the corresponding economic efficiency of LEDs in dynamic operation by means of the LM-80 report and according to the TM-21 calculation method. Furthermore, it should be possible to use the library for component dimensioning, e.g. the heatsink. The primary task was to develop simulation models that can be parameterized with manufacturer information, e.g. the datasheet, but still provide sufficient accuracy. As an application example an LED louvre luminaire (Article Code: 29001077) from LEDON Lamp GmbH was simulated utilizing the developed library. At the end, results from the lifetime- and the economic efficiency simulation were discussed.

LED lighting is about to replace all conventional lighting technologies, e.g. incandescent lamps or fluorescent lamps. This revolution of the lighting industry was triggered by the rapid development of LEDs due to their luminous efficacy, lifetime and costs.

The lifetime of an LED system is specified by the manufacturer. In general, this value is based on the LM-80 report [I] and is calculated using the TM-21 method [II]. The result is transferred to the manufacturer's datasheet. Unfortunately, this value is solely valid for one specific application. Moreover, this application is not regulated by law and can be defined by the manufacturer. A common application is, for example, to use an ambient temperature of 25°C, a continuous full load operation and a specified maximum allowed decline of

luminous flux by 30%. In further consequence the specified lifetime will be used to calculate the economic efficiency of a lighting installation to compare the costs and benefits of the investment.

However, this practice raises a number of delicate questions, particularly with regard to comparability and accuracy:

- How to compare two lighting products with different lifetime information.
- What is the lifetime if a dynamic operating cycle is used?
- What is the lifetime if a dynamic ambient temperature is given?

To answer these questions sufficiently accurate, an LED model has to meet the following requirements: The electric- and thermal behavior has to be

described properly. Ageing, i.e. the decline of luminous flux for different operating cycles, e.g. full load, office or industry has to be modeled. Finally, by utilizing the results from the ageing model the economic efficiency has to be calculated.

In the following paragraphs, the current situation and then a new modeling approach are briefly described and the models of the Modelica library DynaLed are introduced. After explaining how a simulation has to be set-up, an application example is shown and the simulation results are discussed. At the end the most important results will be summarized.

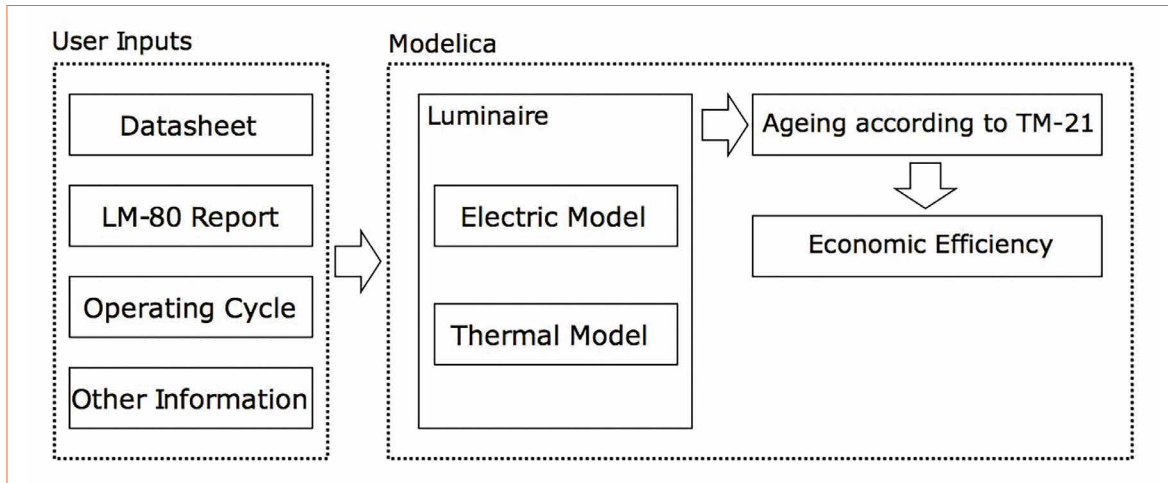

Figure 1:
Simulation approach

Status Quo of Simulation & Improvement Options

Most of the diode models that can be found in literature are based on ideal models [3] or are described by means of the Shockley equation [4]. Both models are used to investigate the switching behavior whereas ideal models are usually preferred to enhance the simulation performance, i.e. fast dynamics of the real behavior are neglected. However, none of these models consider losses (conduction-, turn-on- and reverse-recovery losses). In order to consider losses, several approaches exist that either extend the ideal models or introduce models that utilize characteristic curves specified in the manufacturer's datasheet. The latter ones are so-called behavioral models [5, 6]. The simulation platform PLECS, for instance, provides behavioral models to take the diode losses into account [7]. However, considering an LED, one part of the electric power is irreversibly converted into heat (i.e. losses) while the other part generates the luminous flux. Consequently, the luminous flux cannot be neglected. Some examples of LED models are given in [8] for the simulation software SPICE or in [9] for the Simscape environment. Both implementations are based on the Shockley diode model. The disadvantage of these models is that not all parameters are provided in the LED datasheet which makes them quite hard to use.

The existing thermal simulation and calculation methods range from very simple lumped models (usually electric equivalent circuit, i.e. Cauer and/or Foster networks) to complex CFD-analysis (Computational Fluid Dynamics) [10, 11]. In combination with the electric diode model lumped thermal models are used.

Up to now, there is no standardized calculation model that describes the ageing effects of an LED [12]. However, the IES (Illuminating Engineering Society) developed a simulation approach to predict the lifetime of the LED, called the TM-21 method.

A lot of luminaire manufacturers provide economic efficiency simulation tools on their websites, e.g. [13, 14]. Another approach to calculate the energy efficiency of a lighting system is the lighting energy numeric indicator (LENI). The standard EN 15193 describes how the LENI value can be calculated or measured. The limits of these concepts are reached if the simulation type is changed from steady state to dynamic.

Since currently no model is available in the literature that describes an LED sufficiently accurate, this work is intended to develop a dynamic model of an LED that can be used for lifetime simulations and economic efficiency calculations of dynamic operating cycles. Furthermore, the model can be parameterized with parameters specified in the datasheet and in the LM-80 report

or with parameters that can be measured easily by the user.

Modeling Approach

The basic concept of the modeling approach is shown in figure 1

Basically, the simulation approach can be separated into two main parts. The first part describes the input for the simulation model. Thereby, it is important that all required input can be provided easily by the user.

These inputs are:

- **Datasheet of the LED:** has to be provided by the LED-chip manufacturer and includes information about the maximum ratings and the characteristic values
- **LM-80 Report of the LED:** has to be provided by the LED-chip manufacturer and includes measurement data of the lumen maintenance and the chromaticity for a minimum of 6000 hours
- **Operating Cycle:** must be provided by the user and gives information about the operating time and operating mode of the LED in each time step
- **Other Information:** must be specified by the user and provides information about the environment, the system and the costs

The second part of the simulation approach describes the implementation of the models in Modelica.

Figure 2:
Package structure of the library

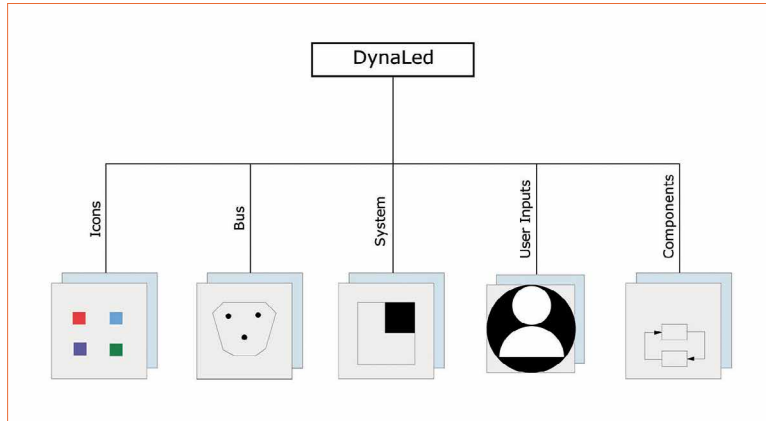

This part consists of the following models:

- **Electrical LED model:** parametrizable with the information from the LED datasheet
- **Thermal model:** parametrizable with the information from the LED datasheet and user information about the heatsink
- **Ageing model:** parametrizable with the LM-80 Report and calculated with the output from the electrical and thermal model
- **Economic efficiency model:** parametrizable with 'other information' and calculated with the output from the ageing model

Both parts present their own challenge concerning the implementation. On the one hand the input should be modeled in a user-friendly way and on the other hand the simulation environment should have a high degree of flexibility with regard to different LED systems. By contrast the difficulty of the implementation of the test environment is to achieve a balance between the computation time, complexity and accuracy of each part of the simulation environment.

In addition, all implemented blocks should serve as a basic library for dynamic lifetime simulations and profitability assessments of LED

systems in the concept stage of the development as well as for products that are already on the market.

Simulation Library

The structure of the DynaLed library for lifetime- and economic efficiency simulation of LED systems is depicted in figure 2.

A short description of each package is given in the list below:

- **Icons:** Includes all icons of the models provided within the library
- **Bus:** Contains all variables of interest. Adapters are used to write signals on the bus and read signals from the bus
- **System:** Consists of the template of the entire system and the data record for the model parameterization
- **User Inputs:** Includes a model for the operating cycle and a model for "other information" e.g. the ambient temperature
- **Components:** This package includes the models and its accompanying sub models for the LED, the heatsink, the lifetime- and economic efficiency calculation

Figure 3:
Top level of the entire model

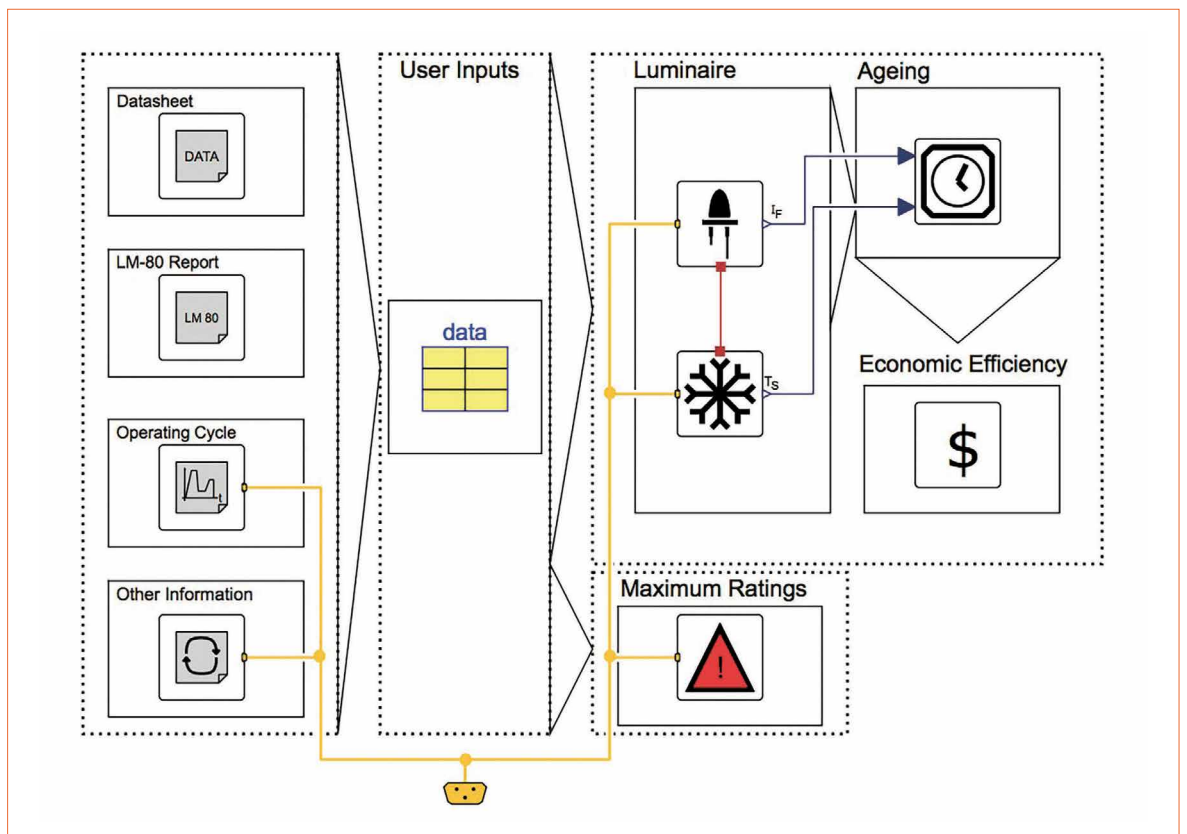

The implementation of the entire system is similar to the simulation approach and is illustrated in figure 3. It consists of five main parts: the user inputs, the luminaire model, the ageing model, the maximum ratings and the economic efficiency model. Additionally, the luminaire model is split into an LED model and a heatsink model. This design is chosen because each model can be replaced individually, leading to a high degree of flexibility.

For the data transmission between the different modules a bus is used. To clearly represent which signal is written to the bus and which is read from the bus, adapters are designed. Therefore, for every signal on the bus a writing adapter and a reading adapter is created.

User inputs and data supply

The required user inputs are separated by the source of origin, i.e. datasheet, LM-80 report, operating cycle and 'other information'. Furthermore, the entire data supply of the models in the DynaLed library is done via the data record, shown in the middle of figure 3. A record is a collection of the model parameters. To parameterize the entire system model shown in figure 3 the record is instantiated and the parameters are propagated to each model.

Luminaire model

The luminaire model is separated into an electric model and a thermal model.

Electric model

An LED is a special kind of diode. The difference to a regular diode is that the LED model is a combination of an electric power model, a photometrical power model and a thermal power model. The schematic signal flows are shown in figure 4.

The top level of the LED model is implemented according to figure 4 and is shown in figure 5.

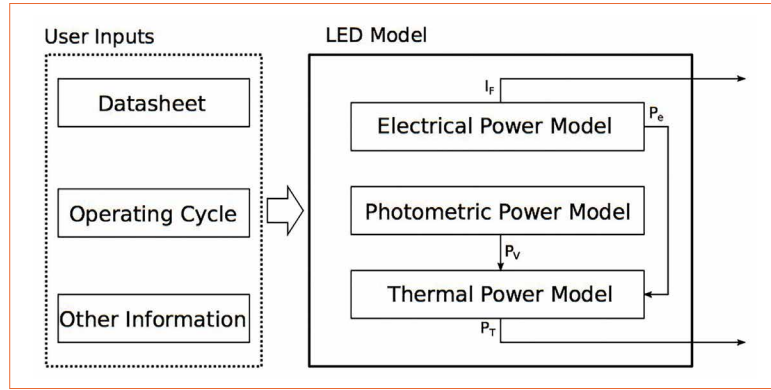

Figure 4: Signal flow of the LED model

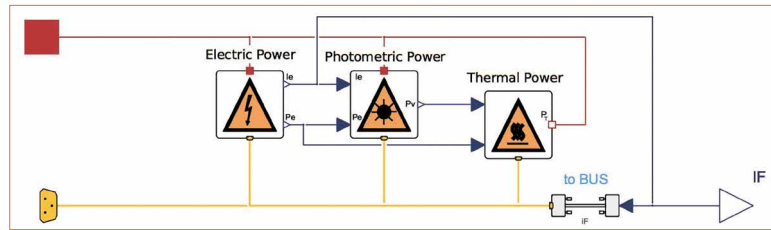

Figure 5: Top level of the LED model

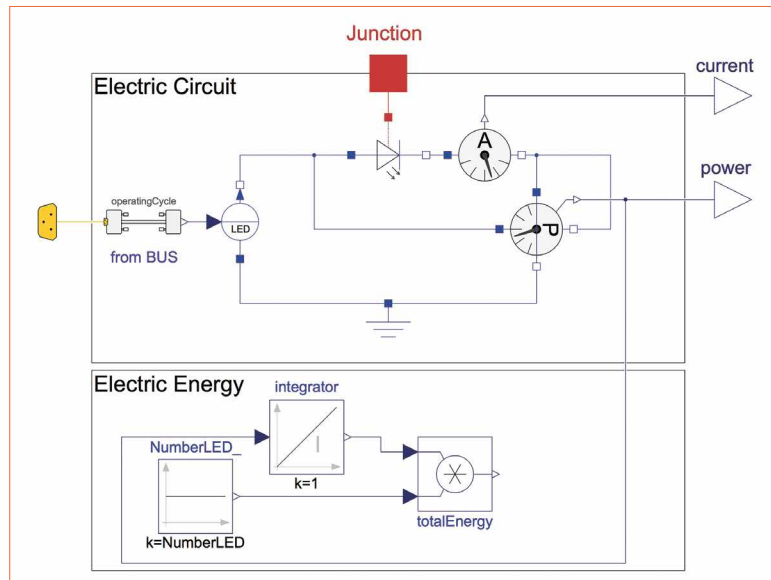

Figure 6: Implementation of the electrical power model

Figure 6 shows the entire electrical power model of the LED. On the top, the electric circuit is modeled consisting of the ballast and an LED. On the bottom, the power consumption calculation of the system with the unit Ws is implemented. Since the electric circuit is solely modeled for a single LED, the measured power consumption is scaled with the number of LEDs in the luminaire. The output of the model is the forward current and the power of the electric circuit.

The ballast is required for the power supply of the LED. The ballast is modeled using an ideal current source that is driven by the product

of the normalized operating cycle and the nominal forward current of the LED. Therefore, the output current is adjusted depending on the operating cycle.

Additionally, the following assumptions for the model of the ballast were made:

- It is an ideal ballast, i.e. its efficiency is 100%
- The lumen output of the LED is linearly depending on the current input

The electrical properties of an LED are equal to the electrical properties of a diode, i.e. to simulate an LED the diode model will be used. There are mainly three different techniques

Figure 7:
Implementation of the LED

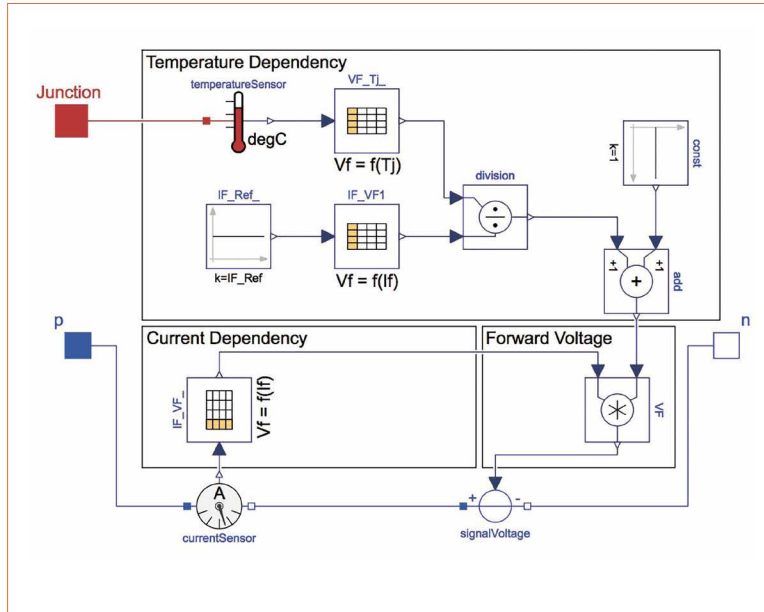
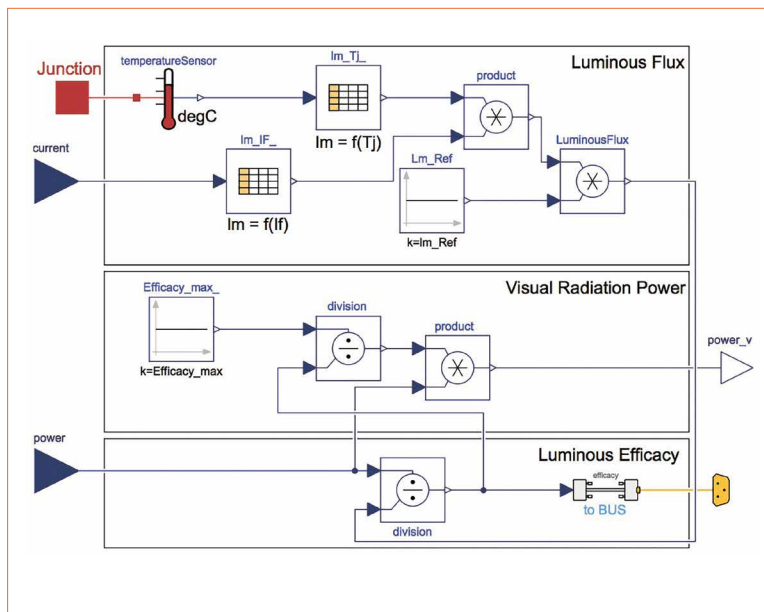

Figure 8:
Implementation of the photometric power model



to model a diode: ideal modeling, physical modeling and behavioral modeling. The ideal model has the disadvantage of precision; drawbacks of the physical model are the parameterization and the simulation performance. Therefore, the most suitable modeling technique is behavioral modeling, because it can be parameterized with parameters and characteristic curves from the datasheet and the results are usually accurate enough to get an understanding of the real behavior of the system.

The LED model is shown in figure 7. The current sensor measures the input current of the LED, which is the input for the table containing the

forward characteristic curve of the LED specified in the datasheet. The output of the table is the current depending forward voltage drop. Additionally, the forward voltage depends on the junction temperature. This dependency can be found in the datasheet as well. To take this into account, the percentage voltage drop depending on the junction temperature at a reference forward current is multiplied with the forward voltage (refer to EQ1). This voltage is the input to the signal controlled voltage source.

$$V_f(I_f, T_j) = V_f(I_f) \cdot \left(1 + \frac{\Delta V_f(T_j)}{V_{fref}} \right) \quad EQ1$$

The photometric power model is also a static behavioral model, see figure 8. The forward current of the LED is the input for the table containing the relative luminous flux characteristic curve of the LED that is specified in the datasheet. The output of the table is the current depending relative luminous flux. Additionally, the luminous flux depends on the junction temperature. To take this into account the relative luminous flux drop depending on the junction temperature is multiplied with the relative luminous flux. To get the absolute value of the luminous flux the relative luminous flux depending on the junction temperature and the forward current is multiplied with the reference luminous flux value.

The next step is to calculate the luminous efficacy of the LED. Therefore, the ratio of luminous flux and electrical power is computed. Based on this and the maximum possible luminous efficacy [III] depending on the spectral emission the photometric output power is calculated which represents the output of the model.

According to the principle of conservation of energy the thermal power is the subtraction of the photometric power from the electric power. This calculation is done in the thermal power model shown in figure 5.

Thermal model

The thermal model is implemented as a Cauer-network. The losses from the thermal power model of the LED are the source of heat flow entering at the junction interface. The heat is transported through the thermal resistance from the junction to the solder point to the heatsink and to the atmosphere. The temperature profile of the ambient temperature is specified in the “other information” model shown in figure 3.

Additionally, the dynamics of the thermal model are implemented using the heat capacitors of the

different elements. All the heat capacitors have to be initialized with the ambient temperature because it is assumed that the system has been in its ambient state long enough so that it has adopted this temperature level.

The implementation is shown in figure 9. The output of the thermal model is the solder point temperature of the LED.

The values for the thermal resistances and the heat capacitors can be taken from the corresponding datasheets and are calculated with the geometrical boundary conditions and material or have to be evaluated via temperature measurements.

Ageing model

The ageing and therefore the lifetime of an LED-system depends on a multitude of influential factors.

The most important factors are listed below:

- **Temperature:** the heat which is produced from losses of the LED has negative effects on several LED parameters, e.g. the lifetime, the luminous flux, etc
- **Current:** each LED is driven with a certain electrical current. The amplitude of this current has a direct effect on its lifetime. The lower the current, the lower the heat generation and the higher the lifetime
- **Radiation and light:** the light that is emitted by the LED has an ageing effect, for example, on the housing or the reflector
- **Mechanical forces:** the reason for applying a mechanical force can be a faulty assembly, high temperature fluctuations, etc. The effect is a premature failure of the LED
- **Humidity:** can lead to corrosion of metal parts inside the LED-module and therefore to a premature failure
- **Chemicals:** chemical substances, like high sulfur dioxide content of the air, have a negative effect on the lifetime of the LED [16]

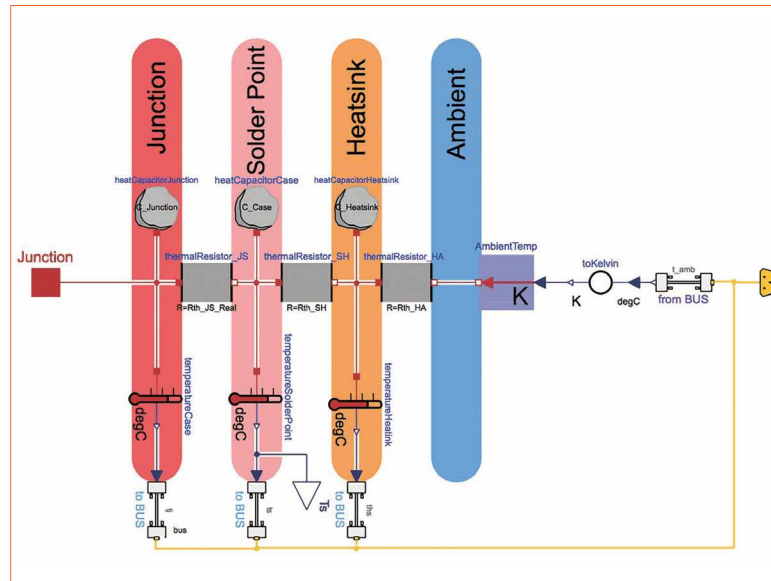

Figure 9: Implementation of the thermal model

For the ageing model the influential factors temperature and current are the only being considered, because in comparison radiation and light have a relatively small impact on the lifetime of an LED. The other three factors are influenced by the end user and can therefore not be considered in a meaningful way.

The ageing model is based on the TM-21 calculation method that is based on the exponential decay (EQ2).

$$\phi_t = B \cdot e^{-at} \quad EQ2$$

Where t is the operating time in hours, ϕ the averaged normalized luminous flux output, B the projected initial constant derived by a least squares curve-fit and a , the decay rate constant derived by a least squares curve-fit as well.

After reformulating EQ2 to EQ3, the time to reach a specific L_x value [IV] can be calculated [2].

$$T_{L_x} = \frac{\ln(B/x)}{a} \quad EQ3$$

EQ 3 is implemented in the ageing model depicted in figure 10. The inputs are on the one hand the forward current from the electric model and on the other hand the solder point temperature from the thermal model. The actual values for the start value B and the decay

constant a are stored in a table and are dependent on the inputs.

The result of EQ3 is the lifetime of the system depending on the forward current of the LED, the solder point temperature and the specified L value. Due to the fact that the forward current and solder point temperature changes dynamically the percentage ageing is integrated over time. Therefore, the result of the ageing model is the percentage ageing of the system after the reviewed simulation period.

Maximum ratings

The task of this model, shown in figure 3, is to monitor the maximum ratings. For a reliable long-term operation of the LED it is important that these values are not exceeded.

The following values are monitored:

- Operating temperature
- Junction temperature
- Solder point temperature
- Forward current

If one of these values exceeds the permitted range the simulation is terminated.

Economic efficiency model

For a meaningful simulation of the economic efficiency the several aspects of a lighting system have to be addressed.

Figure 10:
Implementation of the ageing model

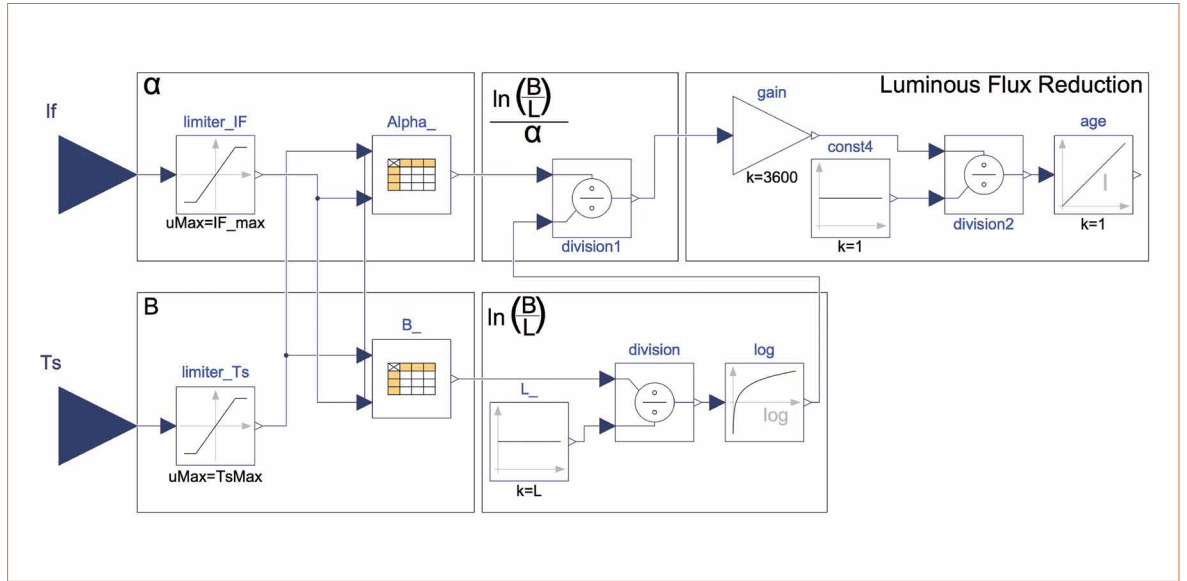

Aspects to being addressed:

- Investment
- Energy procurement costs
- Lighting hours
- Plant lifespan
- Nominal lifetime of the lighting system
- Installed power including all auxiliary units, e.g. ballasts
- Maintenance costs

The economic efficiency model evaluates the total investment I_{tot} of a lighting system over a specified period of time. The total investment can be computed with EQ4. It is the sum of the initial investment I_i for the luminaires including the ballast and the installation, the energy costs I_E for the review period and the replacement costs I_R for the luminaires.

$$I_{tot} = I_i + I_E + I_R \quad EQ4$$

The initial investment I_i consists of the costs for a luminaire I_L including the ballast and the installation costs per luminaire I_{in} . This value is multiplied by the number of installed devices N (EQ 5).

$$I_i = (I_L + I_{in}) \cdot N \quad EQ5$$

The energy costs I_E are the product of the average energy consumption E_a of the luminaire including the efficiency η of the ballast, the number of installed devices N , the electricity costs I_{kWh} and the time period under review t . The calculation is done with EQ6.

$$I_E = \frac{E_a}{\eta} \cdot N \cdot I_{kWh} \cdot t \quad EQ6$$

If a luminaire comes to the end of its lifetime it has to be replaced, i.e. a new luminaire has to be installed. Therefore, each replacement means that an investment in the amount of I_i has to be arranged. The number of replacements is dependent on the period under review t and the lifetime of the system t_{end} . The replacement costs I_R can be computed with EQ7.

$$I_R = \left(1 + \frac{t}{t_{end}} - 1\right) \quad EQ7$$

Running a Simulation

To keep the application of the DynaLed library as simple as possible two functions have been created: One for the lifetime, the other for the economic efficiency calculation.

The function for the lifetime calculation simulates the entire system model from figure 3 for a period of 24 hours, i.e. the stop time of the simulation is 86,400 seconds. Depending on the behavior of the system in this period all values are extrapolated. For example, in order to compute the entire lifetime of the LED, the output of the ageing model, i.e. the ageing after 24 hours, is extrapolated.

This can be done because the model underlies following assumptions:

- The operating cycles are repeated every 24 hours
- The ageing model does not consider the calendrical ageing, i.e. the ageing is solely depending on the solder point temperature and the forward current of the LED

After executing the function for lifetime calculation the results are used to parameterize the economic efficiency model. Afterwards, the function for economic efficiency calculation is called.

The output contains the following results:

- Total investment for the reviewed lifespan
- Initial investment for the luminaires and the installation cost
- Energy costs for the reviewed lifespan
- Number of required replacements of the luminaires

Application Example

An application example, which is available on the market, is used to show the function of the DynaLed library in a real system. The LED System is simulated utilizing the developed Modelica library and the economic efficiency of different operating cycles are compared.

System

The simulated luminaire is an LED louvre luminaire (Article Code: 29001077 - for more information refer to [17]). The light sources of the luminaire are 104 pieces DURIS E5 LED from Osram (Type: GW JDSRS1.EC-FUGQ-5L7N-L1N2). The power supply of the LED is a constant current ballast.

The following three different types are available:

- Ballast DALI dimmable
- Ballast DALI dimmable
- Ballast 1-10V dimmable

The used ballast type depends on the application and in further consequence on the operating cycle.

Results

The results are separated into lifetime calculation results and economic efficiency calculation results.

Lifetime Calculation Results

The lifetime of the system depends, on the one hand, on the forward current and on the other hand, on the solder point temperature of the LED. Therefore, the lifetime of the system varies, depending on the used operating cycle (OC). For the simulation seven different operating cycles are considered. Five of them are appointed to different areas of application and are translated from the human centric lighting curves from [18]. Additionally, a full load operating cycle and a constant light output are added.

The following different operating cycles are used for the simulation:

- Full load (FL)
- Constant light output (CO)
- Education (ED)
- Health and care (HC)
- Office (OF)
- Shop and retail (SR)
- Industry (IN)

The average power of the system also depends on the operating cycle.

The results of the different simulation runs are listed in table 1.

It must be noted that according to the limits of the TM-21 calculation method, only the lifetime of the full load and the constant light output operating cycle are within the boundaries. To verify the lifetime of all operating cycles an LM-80 report is required with a testing period of 26000 hours. The simulation shows that the lifetime of the system is strongly dependent on the used operating cycle.

For further consideration the values from table 1 are not adjusted and are directly used to parameterize the economic efficiency calculation.

Economic Efficiency Calculation Results

For the economic efficiency calculation a simulation period of 100,000 hours was assumed. The purchase price of a luminaire including the ballast, the installation costs and the energy costs are required. These costs depend on a variety of different factors.

Some costs factors:

- Purchase price of a luminaire including the ballast
 - Depends on the used ballast. The non-dimmable ballast is cheaper than the ballast with constant light output. The ballast with constant light output is cheaper than the DALI dimmable ballast. The result is that depending on the operating cycle a suitable driver needs to be selected which has an influence on the price
 - Depends on the discount level of the customer
- Installation costs
 - Depends on the ballast used. The luminaire with the DALI dimmable ballast results in additional installation effort, e.g. more wires, sensors, programming, etc.
 - Depends on the hourly labor costs of the installer
- Energy costs
 - Depends on the contract with the energy provider
 - Depends on the cost increase over the period under review

| Operating Cycle | Lifetime [h] | Power [W/ Luminaire] |
|-----------------|--------------|----------------------|
| FL | 45,564 | 40.13 |
| CO | 56,518 | 35.83 |
| ED | 155,119 | 19.83 |
| HC | 92,475 | 23.09 |
| OF | 109,362 | 22.84 |
| SR | 138,086 | 14.50 |
| IN | 73,921 | 31.73 |

Table 1:
Results of the lifetime simulation

| Operating Cycle | Luminaire [EUR/ Luminaire] | Installation [EUR/ Luminaire] | Energy [EUR/ kWh] |
|-----------------|----------------------------|-------------------------------|-------------------|
| FL | 120 | 25 | 0.15 |
| CO | 170 | 25 | 0.15 |
| ED | 200 | 50 | 0.15 |
| HC | 200 | 50 | 0.15 |
| OF | 200 | 50 | 0.15 |
| SR | 200 | 50 | 0.15 |
| IN | 200 | 50 | 0.15 |

Table 2:
Required parameters for this example

According to the multitude of influencing factors there are no generally valid values for the required parameters. The used parameters are listed in table 2.

The results of the economic efficiency calculation are the total investment I_{tot} , the initial investment I_0 , the energy costs I_E and the number of replacements N_R , see table 3.

Interpretation

The influence of different operating cycles on the lifetime of an LED luminaire and in further consequence for the total costs are depicted in table 1 and table 3.

One illustration is the following: the lifetime of the luminaire increases by a factor 3.4 if the education operating cycle is used instead of the full load one. The full load operating cycle has the

Table 3:
Results of the
economic efficiency
calculation

| Operating Cycle | I_{tot} [EUR] | I_i [EUR] | I_e [EUR] | N_R |
|-----------------|-----------------|-------------|-------------|-------|
| FL | 27,594 | 3,625 | 16,719 | 2 |
| CO | 24,679 | 4,875 | 15,929 | 1 |
| ED | 14,416 | 6,250 | 8,166 | 0 |
| HC | 22,125 | 6,250 | 9,625 | 1 |
| OF | 15,750 | 6,250 | 9,500 | 0 |
| SR | 14,416 | 6,250 | 8,166 | 0 |
| IN | 25,708 | 6,250 | 13,208 | 1 |

advantage of a 42% lower initial cost, because a non-dimmable driver can be used and no additional installation effort is required, the disadvantage

is an increase of the total costs by 91 % if an economic efficiency calculation for a review time period of 100,000 hours is done.

Conclusion

The developed library is a convenient tool for manufacturers for lifetime and economic efficiency simulations of LED systems. The implementation provides a simple and time saving method for any kind of adaptations. It allows the user to simulate and compare different kinds of luminaires with the same library. Furthermore, the handling of the library and the data supply is implemented in a user-friendly fashion. ■

Notes:

- [I] A record of the lumen maintenance, the chromaticity and the catastrophic failures of LEDs. This test will be done at three LED case temperatures (55°C, 85°C and one selected by the manufacturer). The minimum testing period is 6000 hours, whereby the data collection has to be done every 1000 hours. The LM-80 report is provided by every renowned manufacturer. For further information refer to [1]
- [II] The TM-21 specifies how to extrapolate the LM-80 lumen maintenance data to times beyond the LM-80 test time [2]. The disadvantage is that this model is only valid for steady-state applications
- [III] The calculation of the maximum luminous efficacy depending on the spectral emission is based on [15]. For the calculation the spectral emission of the LED and the photopic sensitivity curve of the human eye is required
- [IV] The Lx value describes the reduction in luminous flux. Whereby, x provides the information about the minimum level of acceptable lumen output in percent
- [V] For a sample size of 20 units, the maximum projection is 6 times the test duration of the LM-80 report [1]

References:

- [1] E. Richman. The elusive 'life' of leds: How tm-21 contributes to the solution. LEDs Magazine, 6, 2011
- [2] M. Scholdt. Temperaturbasierte Methoden zur Bestimmung der Lebensdauer und Stabilisierung von LEDs im System. 2013
- [3] M. Otter, H. Elmquist, and S. E. Mattsson. Hybrid Modeling in Modelica based on the Synchronous Data Flow Principle. 1999
- [4] S. O. Kasap. The pn Junction: The Shockley Model. 2001
- [5] A. Wintricht. Verhaltensmodellierung von Leistungshalbleitern für den rechnergestützten Entwurf leistungselektronischer Schaltungen. 1996
- [6] P. Denz, T. Schmitt, and M. Andres. Behavioral Modeling of Power Semiconductors in Modelica. 2014
- [7] A. Courty. MAST power diode and thyristor models including automatic parameter extraction. 1995
- [8] D. Madur, N. Ghatte, V. Pereira, and T. Surwadkar. Modelling light emitting diode using spice. 2013
- [9] MathWorks. Documentation: Light-Emitting Diode. www.mathworks.com, Accessed 2017
- [10] Cree. Thermal Management of Cree® XLamp® LEDs. www.cree.com, Accessed 2017
- [11] Vossloh-Schwabe. Thermal Design of LED Luminaires. www.vs-lighting-solutions.com, Accessed 2017
- [12] C. C. Karl. Einfluss von Wasserstoff auf das Alterungsverhalten von InGaAlP Leuchtdioden. 2014
- [13] LED Blog. Stromrechner für LED Lampen. www.leds-blog.de, Accessed 2017
- [14] Lichtspur. Wirtschaftlichkeitrechner. www.light-trail.com, Accessed 2017
- [15] W. Thomas and Jr. Murphy. Maximum Spectral Luminous Efficacy of White Light. 2013
- [16] Osram. Zuverlässigkeit und Lebensdauer von LEDs. 2008.
- [17] LEDON Lamp GmbH. Impressum. www.ledon-lamp.com, Accessed 2017
- [18] Trilux. HCL-Kurven. www.trilux.com, Accessed 2017



Innovation in Light

Be Empowered

by Trends in Lighting.
What is your inspiration?



TiL is the unique, international “**Innovation in Light**” event, and is dedicated to bridging the gap between technologies and applications. Whether you are an architectural lighting designer, architect, industrial designer, healthcare innovator, advertising agency, automotive strategist, mobility designer, agriculture innovator, entertainment professional, education facility manager, project developer, urbanist, car designer, or investment consultants. *TiL* will reinvigorate your thinking about light in your industry. You will learn from the most compelling innovators, inventors and industry leaders.

Creating Value with Light.

***TiL* is all about sharing talent and passion.**

We look forward to meeting you at *TiL* 2018!

2nd International *TiL* Event

September 25–27, 2018, Opera House Bregenz

www.TiL2018.com

Curated by
ROGIER VAN DER HEIDE
Master in Light



Full-Color InGaN/AlGaN Nanowire LEDs for SSL and Displays

III-nitride based nanowire light-emitting diodes (LEDs) have received a staggering response as a future candidate for solid-state lighting and full-color displays due to their unique and exceptional features including drastically reduced polarization fields, dislocation densities as well as the associated quantum confined Stark effect (QCSE) on account of their effective strain relaxation. Moab Rajan Philip and his supervisor Dr. Hieu P Nguyen in the Nano-Optoelectronic Materials and Devices Laboratory at the New Jersey Institute of Technology (NJIT) present astonishing ideas to fabricate and control the color emission of III-nitride nanowire LEDs via molecular beam epitaxy (MBE) growth techniques. The advantage of such LEDs and their characteristics is also discussed.

High brightness LEDs are already penetrating the market and replacing conventional incandescent light sources and being utilized in areas of general lighting, traffic lights, display applications and automotive lighting. The scope and need for color-tunable novel high efficiency LEDs has never been the same. Engineering these materials has been constrained due to several fundamental limitations, including lattice mismatch and the limitation of bandgap engineered materials. In this regard, III-nitride nanowire structures give flexibility to this problem with the ability to generate high quality tunable color emission without much effort in contrast to the conventional thin-film structures. In this paper, the ability of the III-nitride nanowires LEDs for color tuning via MBE and the fabrication of phosphor-free white LEDs using this comprehensive approach along with the characterization of the fabricated LEDs will be illustrated.

Introduction

GaN-based nanowire heterostructures have been sought out in recent times for their potential to generate emission wavelengths varying from ultraviolet to near-infrared regions, which in turn, gives the lighting industry additional flexibility to develop phosphor-free white LEDs. The latter mentioned phosphor-free nanowire white LEDs has been shown to have tremendous potential because of their higher efficiency, longer lifetime, and better light quality in contrast to existing phosphor-based lighting technologies. Phosphor-free white LEDs have been envisioned in recent times by means of axial or radially aligned bottom-up nanowire heterostructures including dot/disk/well-in-a-wire or core-shell structures. Their device performance, however, is severely constrained because of nonradiative surface recombination. The large surface recombination is reflected from the very short carrier lifetime (0.3 ns) values reported for conventional nanowire structures. The use of AlGaN shell in InGaN/(Al)GaN core-shell LEDs leads to an

enhancement in the carrier confinement and reduced nonradiative surface recombination, thus resulting in an overall boosting of the carrier injection into the active region of the LED device. In the afore-mentioned context, a unique core-shell nanowire LED heterostructure was introduced by utilizing self-organized InGaN/AlGaN heterostructure. Such LED structures offers significantly improved carrier injection efficiency and output power, in comparison to the typical InGaN/GaN nanowire LEDs. By altering the size and/or composition of the InGaN active region in the core-shell nanowire LED arrays during the epitaxial growth of nanowire LEDs, the device light emission properties, including the correlated color temperature (CCT) and color rendering index (CRI) can be readily modified. The electroluminescence (EL) spectra show a very broad spectral linewidth and fully cover the entire visible spectrum. The fabricated InGaN/AlGaN LEDs exhibit excellent current-voltage characteristics. The phosphor-free InGaN/AlGaN nanowire white LEDs

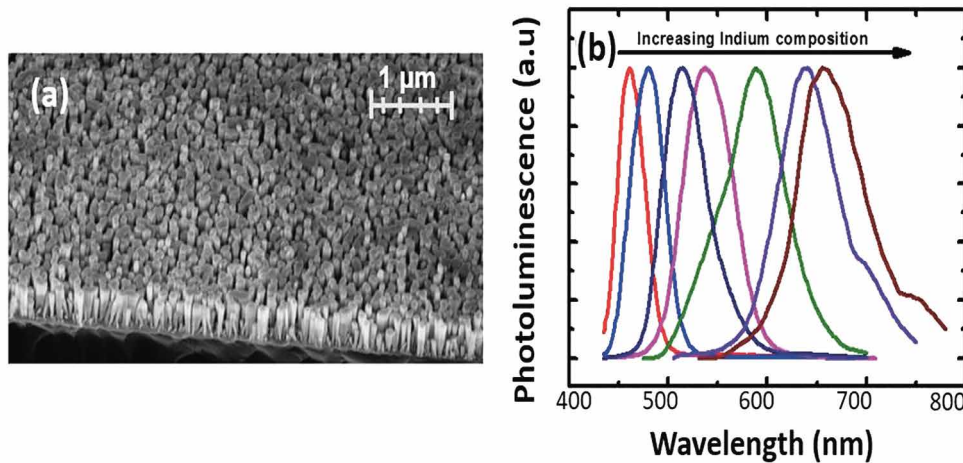

Figures 1a&b: A 45-degree tilted SEM image (a) of the InGaN/AlGaN core-shell nanowire LED grown by MBE. Normalized room temperature photoluminescence spectra (b) depicting multiple emission colors from different InGaN/AlGaN nanowire LEDs [1]

display high CRI up to ~98, which is more efficient compared to the current phosphor-based white LED technologies. Moreover, we have successfully fabricated phosphor-free nanowire LEDs onto metal substrates via a substrate transferring process. Compared to conventional nanowire LEDs on Si, nanowire LEDs on copper (Cu) exhibit several advantages, including more efficient thermal management and enhanced light extraction efficiency due to the usage of metal-reflector and highly thermally conductive metal substrates. The LED on Cu, therefore, has stronger photoluminescence, electroluminescence intensities and better current-voltage characteristics compared to the conventional nanowire LED on Si, paving the way for a whole new generation optoelectronic device for the future solid-state lighting, flexible displays and wearable electronic applications.

Device Structure

The InGaN/AlGaN LED nanowire heterostructures, were spontaneously grown on n-type Si substrates under nitrogen rich conditions by a radiofrequency plasma-assisted nitrogen source equipped Veeco Gen II MBE system. Silicon and magnesium were used as *n*- and *p*-type dopants for GaN nanowires, respectively. The LED active region consists of ten vertically aligned InGaN dots, sandwiched between 3 nm AlGaN barrier layers.

The nanowire diameter and density can be tuned by varying the substrate temperature and/or In/Ga flux ratios, whereas the nanowire length can be controlled by the growth duration. The 45-degree tilted SEM image (Figure 1a) shows uniform nanowires with high areal density of $\sim 1 \times 10^{10} \text{cm}^{-2}$. During the growth process of AlGaN barrier, an AlGaN downward-bending shell layer was also formed around the InGaN layers due to the diffusion-controlled growth process [1, 2]. These core-shell structures exhibit low nonradiative surface recombination, and improved carrier injection efficiency compared to InGaN/GaN nanowire LEDs without using core-shell structures.

Results and Discussion

The emission wavelengths can be readily engineered across the entire visible wavelength regime thus easily generating the full color spectrum. The optical properties of InGaN/AlGaN LED nanowire heterostructures (Figure 1b) revealed that peak emission wavelengths of InGaN/AlGaN core-shell nanowire LEDs ranging from 460 to 670 nm can be attained. The effective variation of the In composition in the active region of the InGaN active region was achieved by controlling the growth temperatures and/or In/Ga flux ratios. The longer wavelength like red light is often linked with a lower bandgap material for the active region. Thus, the desired color emission from blue

to red color in the visible regime of the electromagnetic spectrum viz towards a higher wavelength was obtained by altering the In composition from a lower value to a higher value. The latter engineered heterostructures are being used to realize multiple color devices as expected.

Furthermore, the core-shell LED samples have an enhanced optical intensity (a factor of >8 times higher of photoluminescence intensity) in contrast to the conventional InGaN/GaN device. This has been linked to the fact that radiative recombination is more assertive on account of the effective carrier confinement in the active region of InGaN/AlGaN LEDs, being more efficient when compared to that of InGaN/GaN LED devoid of AlGaN core-shell structures. This enhancement is associated to the strong carrier confinement, due to the effective lateral confinement offered by the large bandgap AlGaN barrier and drastically reduced nonradiative surface recombination. In addition, the core-shell InGaN/AlGaN LEDs boasts of significantly improved carrier lifetime, which is more than 15 times higher when compared to the conventional InGaN/GaN LEDs. The latter improved carrier lifetime stems from the reduced nonradiative surface recombination arising due to the effective lateral confinement offered by the higher bandgap of AlGaN shell layer in the core-shell LED structure.

Figures 2a&b:

Electroluminescence spectra of various InGaN/AlGaN LEDs (a) with distinct emission colors, along with their optical image. Electroluminescence spectra of the phosphor-free core-shell nanowire white-LED (b) under injection current along with the optical image of the white LED [1]

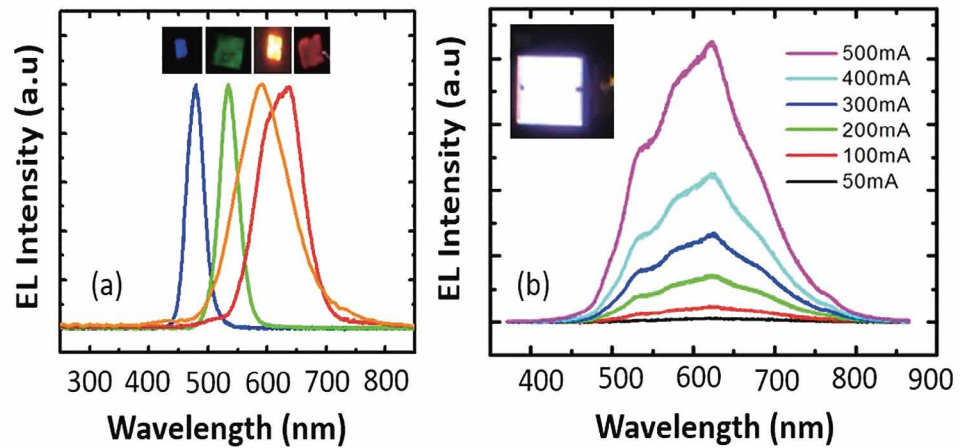
**Figures 3a&b:**

Electroluminescence spectra of phosphor-free white LED (a) and CIE 1931 chromaticity diagram (b) illustrating the emission characteristics of the same InGaN/AlGaN nanowire LEDs [1, 3]

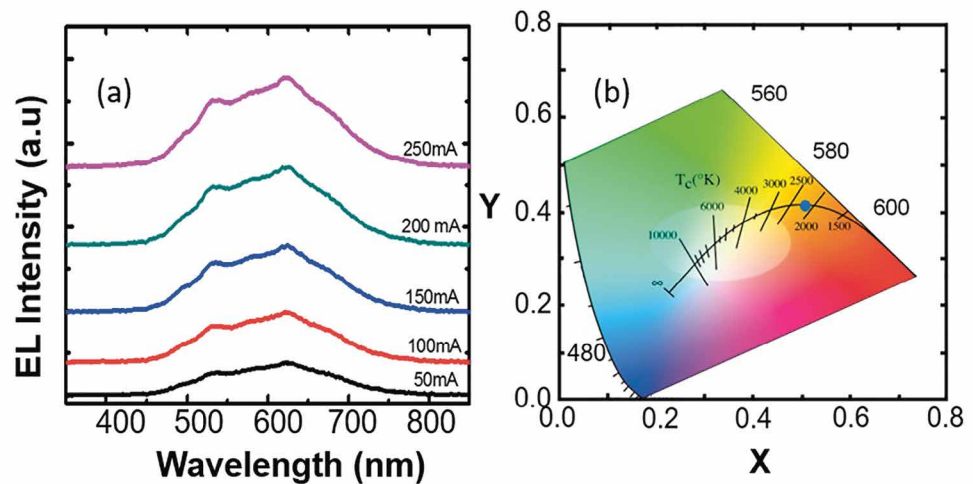

The electroluminescence (EL) spectra and the optical image of LED devices (Figure 2a) generated multiple color emission with peak wavelengths ranging from 475 to 650 nm within the InGaN/AlGaN LEDs, thus reaffirming the multiple color photoluminescence spectra. Multiple color emissions were combined within InGaN active region of a single AlGaN nanowire device, leading to a strong and high-quality phosphor-free white light emission, evident from optical micrograph image (Figure 2b) [1, 3]. The EL spectra of phosphor-free LEDs were measured under 1% duty cycle pulsed biasing conditions (to minimize junction heating effect) presented an emission spectrum with very broad spectral linewidth of more than 150 nm, fully spanning the entire visible spectrum regime. Moreover, the spectra are highly

stable and nearly independent of injection currents [2].

The CRI of phosphor-free white LEDs can be engineered by controlling the In composition in the InGaN active region, thus leading to various emission spectra and different spectral power distribution (SPD) characteristics. In contrast to conventional planar LEDs, InGaN/AlGaN core-shell nanowire LEDs offer a unique feature of providing flexibility in engineering the peak emission wavelengths and spectral linewidths, which in turn are the two most vital criteria for CCT and CRI. The EL spectra with injection currents varying from 50 mA to 250 mA for phosphor-free white LEDs is provided in figure 3a while the Commission Internationale de l'Éclairage (CIE) coordinates for the same LED device is depicted in

figure 3b. The fabricated white LED exhibits broad spectra with a fullwidth of half maximum of ~171 nm and offers SPD values in the range of 410–800 nm, respectively. The resulted CRI values of around ~98 were measured for those phosphor-free nanowire LEDs.

III-nitride nanowire LEDs are normally grown on Si substrates, which may largely absorb photon emitted from the LED active region, severely limiting the light output power. Moreover, Si semiconductor generally exhibits low electrical conductivity and thermal expansion coefficients compared to metal substrate. High power LED applications, however, require large-area device size and operate at high injection current which mostly will heat up the devices. The resulted

Starring CAS 140D!



See us at
light+building
Booth 4.1/K89

This spectroradiometer sets the standard for LED/SSL and display:

- ▲ Superior measuring sensitivity, precision, dynamic range and minimized straylight
- ▲ Constant repeatability in changing ambient temperatures
- ▲ Faster electronics with higher resolution
- ▲ “Plug & Play” accessory identification
- ▲ Proven lab and production software: SpecWin Pro/Light, DLL and LabView
- ▲ Also available for UV or NIR applications

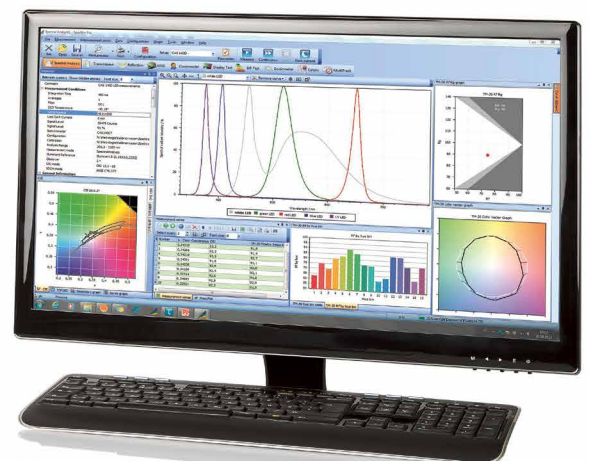

We bring quality to light.

Figures 4a&b:
Current-voltage (a)
and light output power
(b) vs injection current
characteristics of the
conventional nanowire
LED on the Si substrate
and nanowire LED on
metal Cu substrate [4]

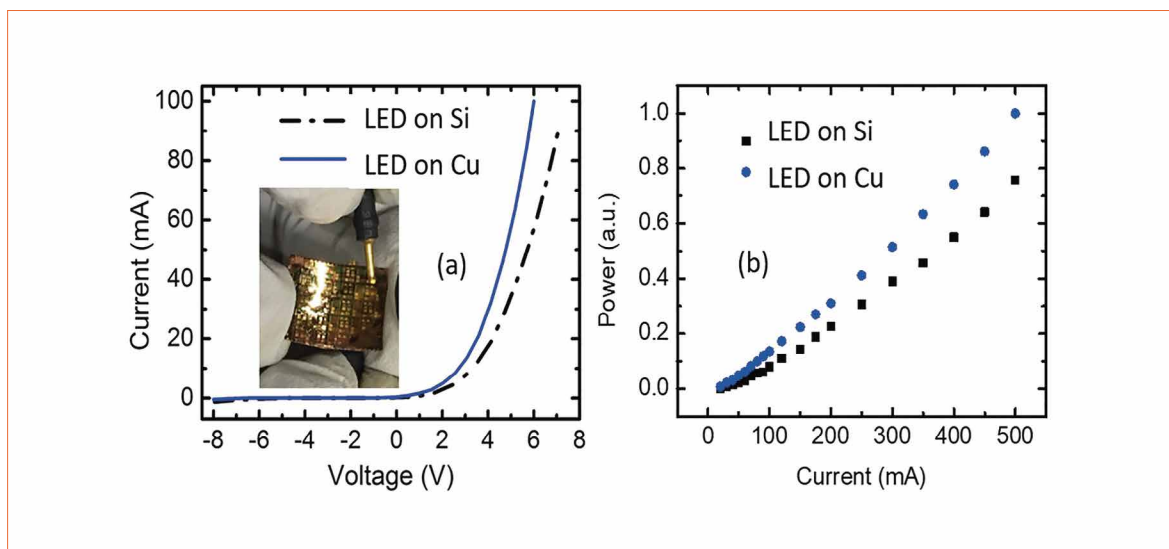

quantum efficiencies, output power and lifetime reduce rapidly when the junction temperature increases. Therefore, managing heat dissipation should be seriously considered. Besides the applications in solid-state lighting illumination, the use of LEDs in telecommunications, and decoration displays for flexible electronics devices has also been intensively developed due to the feasible integration of such LEDs in these electronic devices. In this regard, we have successfully fabricated full-color and phosphor-free white LEDs on Cu substrates. Nanowire LED structures were first grown on silicon-on-insulator (SOI) substrates by MBE, then were transferred onto Cu substrates via the substrate-transfer process. Compared to conventional nanowire LEDs on Si, nanowire LEDs on Cu exhibit offer more efficient thermal management and enhanced light extraction efficiency due to the

usage of metal-reflector and highly thermally conductive metal substrates. The LED on Cu, therefore, has stronger photoluminescence, electroluminescence intensities and better current-voltage characteristics compared to the conventional nanowire LED on Si. The LEDs on Cu substrate exhibit excellent current-voltage characteristics and show lower leakage current and slightly higher current in forward bias, compared to the LED device on Si substrate at the same voltage, shown in figure 4a. The optical image of light emission from the LED device on Cu substrate is presented in the inset of Figure 4a. Illustrated in Figure 4b, the nanowire LED on Cu shows higher light output power compared to that of nanowire LED on Si [4]. The enhanced output power is attributed to the enhanced light extraction efficiency and better heat management in LED on Cu substrates which was explained previously.

Conclusion

In conclusion, high performance InGaN/AlGaIn core-shell nanowire LEDs on Si and metal substrates have been developed. The color properties of such full-color nanowire LEDs can be adjusted by controlling the indium composition in the InGaN/AlGaIn active region of the LED structures. This study addressed some major roadblocks for the practical applications of nanowire-based LEDs and has further provided an entirely new avenue for the development of future high efficiency phosphor-free white LEDs as well as full-color LEDs with tunable emission for advanced lighting applications. ■

References:

- [1] M. R. Philip, D. D. Choudhary, M. Djavaid, M. N. Bhuyian, J. Piao, T. T. Pham, et al., "Controlling color emission of InGaN/AlGaIn nanowire light-emitting diodes grown by molecular beam epitaxy," *Journal of Vacuum Science & Technology B, Nanotechnology and Microelectronics: Materials, Processing, Measurement, and Phenomena*, vol. 35, p. 02B108, 2017
- [2] H. P. T. Nguyen, M. Djavaid, S. Y. Woo, X. Liu, A. T. Connie, S. Sadaf, et al., "Engineering the Carrier Dynamics of InGaN Nanowire White Light-Emitting Diodes by Distributed p-AlGaIn Electron Blocking Layers," *Scientific Reports*, vol. 5, p. 7744, 2015
- [3] M. R. Philip, D. D. Choudhary, M. Djavaid, K. Q. Le, J. Piao, and H. P. T. Nguyen, "High efficiency green/yellow and red InGaN/AlGaIn nanowire light-emitting diodes grown by molecular beam epitaxy," *Journal of Science: Advanced Materials and Devices*, vol. 2, pp. 150-155, 2017
- [4] M. Rajan Philip, D. D. Choudhary, M. Djavaid, M. N. Bhuyian, T. H. Q. Bui, D. Misra, et al., "Fabrication of Phosphor-Free III-Nitride Nanowire Light-Emitting Diodes on Metal Substrates for Flexible Photonics," *ACS Omega*, vol. 2, pp. 5708-5714, 2017

Natural & Healthy Light

SunLike
Powered by 

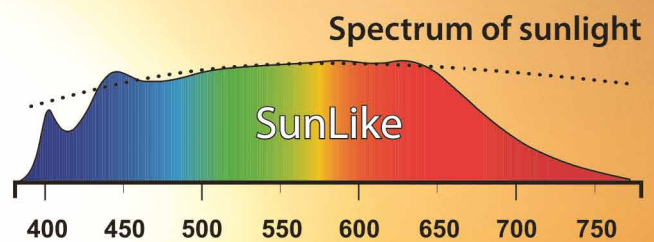

- Improves the light experience for human health benefits
- Closely matches the spectrum of natural sunlight
- Harmonizes light output with natural circadian rhythms
- Minimizes negative effects of conventional LED light sources



SEOUL SEMICONDUCTOR

Visit seoulsemicon.com to learn more about SunLike Series LEDs.



Technology Is the Answer, But What Was the Question?

In cooperation with the Lucerne University of Applied Sciences and Arts, Electrosuisse held the LED Forum 2018, which focused on “Human Centric Lighting in Practice”. Arno Grabher-Meyer from LED professional was invited to attend the first class one-day event, held at the end of January for the DACH (Germany, Austria and Switzerland) region at the Basel Congress Center.

Prof. Bjoern Schrader from the University of Lucerne aptly entitled his short opening speech “Technology Is the Answer, But What Was the Question?” This headline perfectly describes the current situation of lighting planners and electro planners. Product managers, developers of lighting applications and the rest of the audience have surely also recognized the truth of that title in their businesses.

Everyone that is involved in the lighting business has had to accept that with the introduction of LEDs the digital era began. Not being a part of a slowly changing world with life cycles

of several years, the whole community is now facing all the pros and cons of the IT and semiconductor businesses; especially the extremely short life cycles of only a few months. New products and technology changes must be continuously monitored and are dictating daily business. Keeping track, at this lightning pace, is a challenge. And finding the right technology for the application is even more challenging. So it is not surprising that the original question might fade away and one may lose their orientation and focus.

The aim of this well-structured event was to give assistance to

the target groups: To get an overview or to learn about more specific hot topics or to raise awareness for the situation in general. To fulfill this goal, the event started and ended with a joint session. The topics in the main event were, Lighting Technologies & IoT, Light Planning, Street- and Outdoor Lighting, Planning and Installation of LED Lighting Sets were held in four parallel tracks.

In the following report, Arno Grabher-Meyer communicates his impressions of the event and summarizes the lessons learned from the Lighting Technology and IoT track.

With a total of over 600 participants, the organizer's expectations were clearly surpassed



The Opening Session and Keynote Speeches

Prof. Schrader outlined the status quo and revealed the true problems of the lighting community. He pointed out that the LED hype caused a lot of rumors and discussions about technology and that a lot of information about the technology is now available. Unfortunately, there isn't a lot of useful information available about opportunities and how to apply it correctly. Prof. Schrader identified "HIB" as the most important element of the future of lighting. HIB is the combination of HCL (Human Centric Lighting), IoT (Internet of Things), and BIM (Building Information Management).

In the opening session Prof. Mathias Wambsganss, Prof. Tran Quoc Khanh und Sabine De Schutter warmed up the audience for the conference topics and the four sessions. While presenting very different aspects, the speakers all seemed to agree when they pointed out the importance of "good light" for humans. They demonstrated that a lot has changed and that lighting designers, meanwhile, have to have a much broader understanding than in the pre-LED era. Knowledge about HCL, IoT and BIM is now required. More than ever before, an interdisciplinary education is necessary to give lighting designers the necessary tools.

Prof. Wambsganss questioned how the term HCL is often used. He proposed to talk about integrative lighting in accordance to CIE DIS 017:2016, 17-29-030 to better express that visual and non-visual effects are included. He emphasized the updated DIN specifications, DIN SPEC 67600 and DIN SPEC 5031-100 that consider the current knowledge about ipRGC and their importance for sub-conscious non-image-forming functions that are important for our normal biological activities and health. He criticized that with the "LED hype" and the energy saving trend one important element of HCL is not adequately recognized;

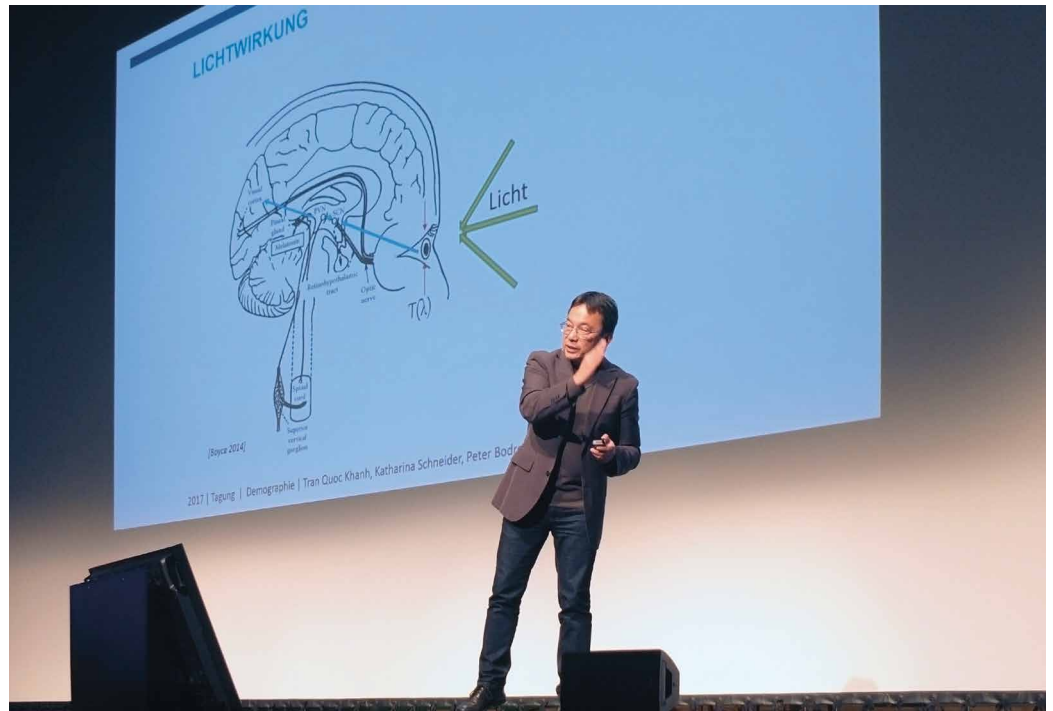

natural sunlight. Prof. Wambsganss demonstrated that lighting is not a luminaire, but lighting has to be treated as a complex system consisting of many elements and it needs to be managed as a project.

Prof. Tran Quoc Khanh presented his findings about the demographic transition in visual behavior and the consequences for future lighting technologies. He argued the importance of this topic by showing the transitions in the age pyramid until 2050 and the accident statistics that show an over-proportional amount of older people being affected. Light and visual capabilities are recognized as being one important reason for this. Prof Khanh explained this conjuncture with biological facts. With increasing age, opacification of the eye dramatically increases and the number of axons decreases by about 25%. In addition, the relative amount of needed light to maintain a similar contrast, hence object differentiation, increases by a factor of two. Glare sensitivity of the visual system of older people is also significantly increased. Among other factors, this all asks for measures - sometimes apparently conflicting measures: While blue light especially causes opacification of the lens, more blue light is necessary for

good vision. He is convinced that true human centric lighting also has to consider these facts. Street lighting projects for public spaces is one example of when these facts need to be taken into account.

In the last key note speech Sabine De Schutter explained the possibilities of triggering impulses for cities with lighting workshops. People in general don't really know much about light and especially not about good lighting. Most of them don't even recognize that it's light that they are missing in their cities: Good, correctly applied and attractive light! She learned about light and lighting design at the end of her academic training to become an architect by accident. The idea fascinated her from the beginning and she recognized the dilemma and decided to improve the situation. Her idea: Organizing lighting workshops and festivals. She explained the goals and the success of these activities using the example of the "Tartu in Lights" festival in Estonia. The objective of the lighting design workshops were to be an experimentation ground for lighting in the public realm which aims to investigate and improve the city's current urban lighting and to create real size prototypes for citizens and visitors to experience.

In an animated lecture, Prof. Dr. Khanh introduced the audience to the physiological aspects of vision and the relation between age and visual capabilities



Sabine De Schutter demonstrated how lighting events and workshops can give momentum to improve light quality in cities and revitalize urban life

The second element of this concept, the modern lighting master planning, demonstrates that planning modern public lighting requires a holistic approach that deals with the many complex aspects involved and that lighting is not only a matter of safety, security and mobility, but serves as a tool for creating identity and livable cities. The “Interactive light” workshop helped people to learn that one can do much more with light than just switching it on and off. Light can also be interactive and responsive to various actions, like proximity, temperature, touch and much more. The so-called “Guerilla Action & Workshop” might be one of the most important activities. It is an open source idea for creating magical moments of quality lighting that demonstrates the power of light to transform spaces. Furthermore, guerrilla lighting is a “war” on bad lighting, but most of all, it is about having fun and raising the awareness of the power of light. While the low financial support for the first event of this kind in Tartu was a huge challenge, the success was more than remarkable, especially because while the light of Tartu2016 has faded it will light up the city again in autumn 2018.

From the Four Parallel Sessions

After one and an half hours of interesting keynote speeches that really concerned everybody, the audience had the choice between the above-mentioned specialty sessions before the closing session brought all the participants together again. While the other three sessions would certainly have also been worth discussing, the following can only summarize what was presented during the “Lighting Technology and IoT” session - chaired by Michael Meesters.

Marc Fontanive, project leader and electrical engineer at Buehler & Schreder, explained what look out for when controlling a tunable white system with DALI. Right at the beginning he cleared up a common misunderstanding. Controlling tunable white lights has nothing to do with using DALI2, as DALI2 is related to the controller only. But the key lies in the operating device, and here, the devices, type 6 (DT6) and type 8 (DT8), have to be distinguished. Basically, tunable white systems may also be realized with the older DT6. But it is

more complicated and limited. Such a solution needs two addresses/devices, it cannot be controlled by a broadcast, cannot be color calibrated, and dimming, while maintaining a specific color point, is not possible. DT8 devices are still rarities on the market, but they need just one address, understand a broadcast, can be calibrated and both CCT and brightness can be controlled without interfering with each other. This means brightness stays stable when the CCT is changed and vice versa.

Horst Rudolph, Director of Research and Lighting Technologies at TRILUX, titled his lecture “Future- and Digital Lighting”. He described the current situation as follows: For the last 10 years, efficiency was the major argument, light quality has been ignored, and it is, unfortunately, still just “nice to have”. He identified self-configuration technologies as key elements for future lighting systems. Mr. Rudolph also emphasized that the step from a product to a system that leads to a disruption on the market is not just an engineering task, but needs appropriate lighting design.

While often the support for additional sensors is a major argument for IoT based lighting, he explained that sensors that are necessary for smart lighting and HCL can already provide interesting additional information. On top of the to-do list for HCL products is ease of use and the individualization of HCL systems. He emphasized the cultural difference between the USA, Asia and Europe in respect to lighting preferences and use as well as the regional differences that make individual solutions necessary. For him, individualization could also mean that one has his own unique profile always with oneself, maybe stored on a mobile device. This profile could then be applied to lighting systems all over the world; not just at home but also in the office, in a hotel, and so on.

In the talk “Internet Protocol (IP) based Lighting – Sense or Nonsense?” Volker Barth addressed IoT in general and especially in IPv6 based networks which he recognized as being key elements for the future of lighting and many other applications. Volker Barth, from Tridonic, who started his career as an electrician before he continued with his advanced education to become an industrial engineer, knows what he is talking about as he also knows about the issues of planning electrical installations. For him, the network is the basis of the whole system and with its simplicity or complexity the chances to succeed rise or fall. He explained several application examples and finally proposed “Thread” to be used as a universal network protocol in future applications. While having some similarities to BT, Thread combines the best of different worlds. One of the biggest advantages of Thread based nodes is that they can be implemented in any IP network as an end-to-end solution without the use of gateways, making a properly designed system less vulnerable. Within the local network, every node is part of a mesh network, connected with a standard router to the internet. Thread manages the

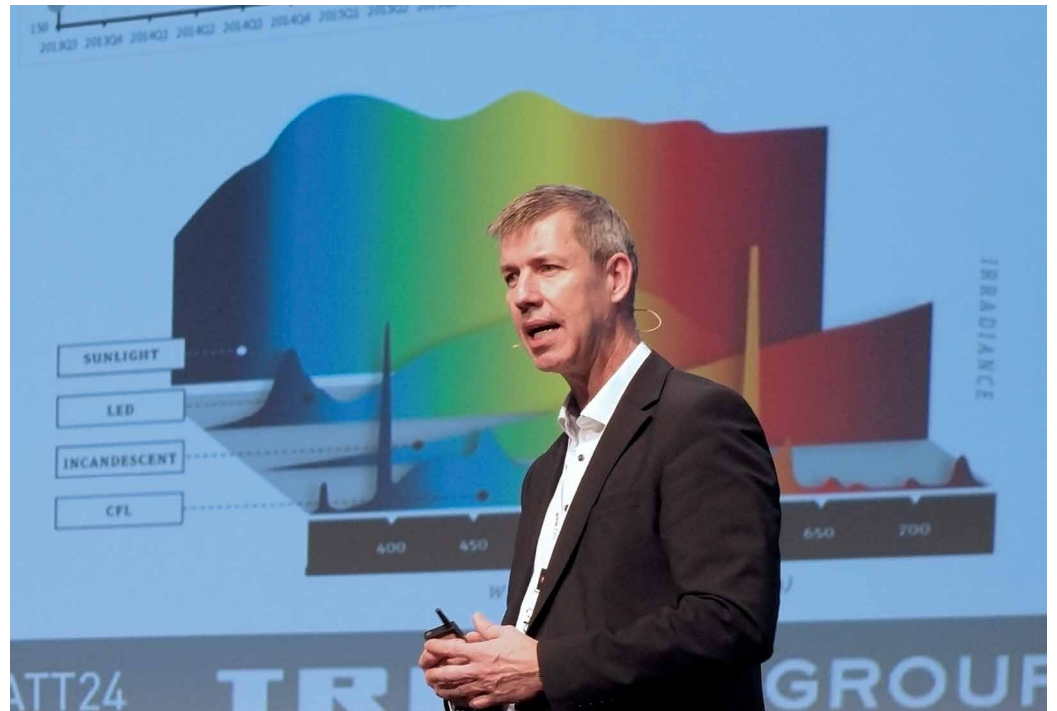

security and commissioning level between the IEEE MAC layer and the application layer. To do this job, it does not require any new hardware. Another advantage is that for existing building management systems the option of connecting with a gateway is still a possibility. Thread gives you the freedom to choose different solutions.

Beat Haenni is the leader of the department for environmental management at the Suisse Post AG.

He talked about “Added Value due to IoT: From Light to a Smart Button. The Suisse Post AG currently manages 1.8 million square meters of illuminated spaces with a significant energy consumption that create enormous costs. Using the example of the Haerkingen site, he showed how IoT and LED lighting could improve a business and reduce costs. He demonstrated several IoT implementations. Replacing an already comparatively efficient lighting solution led to a

Horst Rudolph pointed out the return of the industry to focusing on light quality after a decade of mainly targeting energy efficiency

Volker Barth explained how modern lighting fits in the future IoT ecosystem



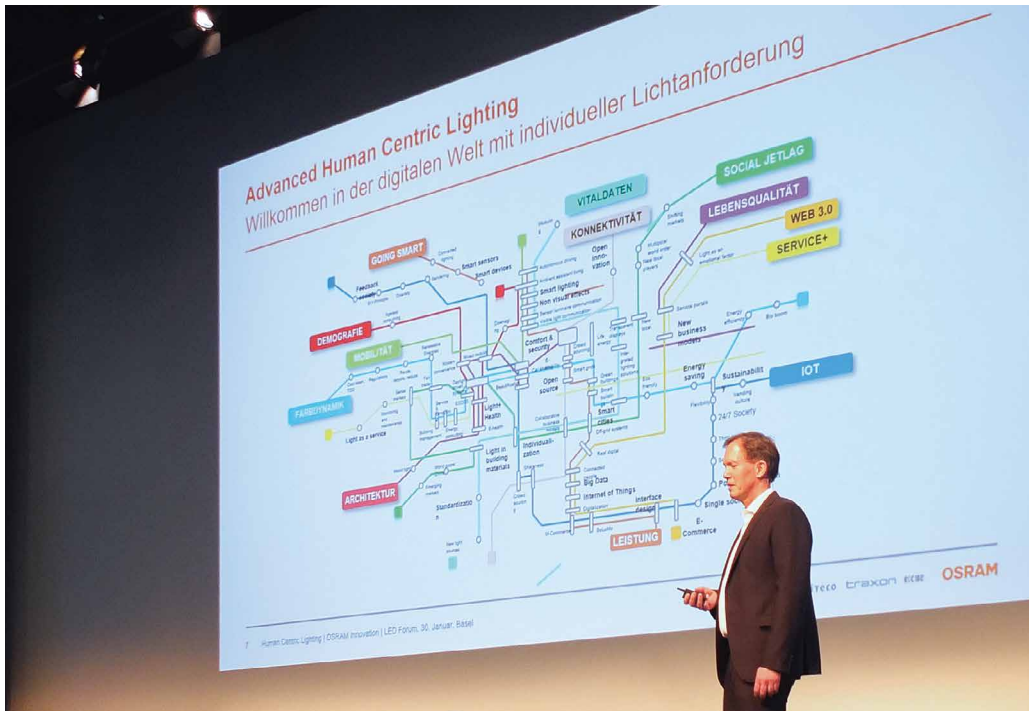

Andreas Steiner explained the complexity of advanced HCL systems with a graph that had a striking resemblance to a subway map

Gerry Hofstetter, an orator with an incredible history, delivered an unforgettable closing speech

surprisingly high reduction in energy usage. While the estimations predicted 50-60%, the measured reduction on site is proven to exceed 80%. But another value was generated with the application of IoT that the company did not think about at first. New ideas are continuously coming up. Simple IoT push buttons for different devices were installed all over the site. With these buttons the users can activate a service request for the device. A service will be provided

precisely when needed and not in a regular cycle whether it's needed or not. This dramatically reduces the man-hours of the service team. Overhead costs could be reduced with IoT. Recently the company also started a study on the efficient employment and productivity improvements of the staff pertaining to the implementation of new technologies including IoT and HCL.

Before the common closing session, a podium discussion addressed

several interesting questions. The most important insights from the discussion were:

- HCL, IoT and other new technologies are badly needed for Europe's lighting industry. Otherwise the companies are just in a price war with products from the Far East that they cannot win
- User and user acceptance of these new technologies has to have focus and, to obtain this acceptance, information and education is inevitable
- The lighting companies cannot completely carry out the education of the public. They may educate electro planners, but the end user education and information has to be accomplished by others, maybe new players
- Other success factors are, at first, the adherence of the users' privacy, simplicity of use, and clear perceptibility of an added value for the user

The Closing -Seeing Beyond the Own Nose

The closing session started with Osram Lighting Services Ltd. CEO, Andreas Steiner's topic "Advanced HCL – Digital Concepts in Practice". He emphasized that lighting cannot easily be divided into separate areas and much less be reduced on illumination. He identified four connected areas: Lighting, sensing, visualization, and therapy. His company is working on solutions in all of these fields. He explained the importance of illumination and the chances for the lighting industry in one example: As it becomes more and more necessary to offer incentives for getting young talents for a company, feel-good factors, like a pleasant atmosphere, are getting more important, and lighting is a relevant part of that. He also gave practical examples where HCL and IoT were combined to providing additional value and he pointed out that there are many ideas and use cases that cannot be predicted from the lighting industry but that are addressed by potential



users: For example, a lounge chair including HCL that is controlled by the vital data of the user. The idea was generated by the German police due to the space restrictions in their offices. Mr. Steiner also demonstrated how the nursing effort in dementia patients can be reduced using the new technologies.

The final highlight was Gerry Hofstetter's talk "Light - Communicates, Inspires and Touches" with a video about his artistic projecting ventures. Gerry Hofstetter is known as the man who projected the Swiss Cross on the Matterhorn. But this is just one of dozens of projects around the world. He and his team take

great efforts at the most remote areas of the world to perform spectacular projections and to document them with impressive videos and photos. His story and career and the presented video was very impressive and left nobody untouched. This showed that he got it right: Light touches, and light is what makes the picture that tells more than a thousand words!

Final Thoughts

While the final video really did steal the show, it also demonstrated the power of light. Keeping this in mind is important, and the same message was also part of the program in one way or another. The event focused

primarily on planners and lighting designers. It didn't really address engineers that design LED modules, luminaires or drivers. Nevertheless, it could also be a good idea for the latter to attend such events from time to time because it brings technicians closer to the application and can lead to fruitful discussions between the two worlds. ■



Iceberg in the Arctic. Illuminated by Light Artist Gerry Hofstetter (Image: ©Gerry Hofstetter)

A Near Infrared Enhanced LED Lighting Approach

With the evolution of LED lighting, one topic has come more and more in the focus of the lighting industry: Human Centric Lighting (HCL). While HCL is not clearly defined, a common understanding is that this is light and lighting that supports health and the well-being of humans. Some new proposals are going beyond the approach of providing just visible light in adequate quality, but also to providing invisible radiation, UV and/or NIR that support health and well-being. Some research and the evolution of humans show clear evidence for positive effects of this kind of illumination. Scott Zimmerman, CEO at Silas, presents a new approach that adds NIR radiation to LED illumination. He explains the background of this idea, how it also improves the quality of visible light and discusses the health benefits.

For millions of years the sun has provided approximately 90% of its energy in Near Infrared (NIR) and Visible (VIS) wavelengths with the remaining percentage being roughly divided between ultraviolet (UV) and mid/long infrared (IR).

In a very short evolutionary time frame (200 years) we have moved from a predominately agrarian society where we spent 90% of our time in the sun to the present where we spend 90% of our time under artificial lighting (EPA estimate). In that same time frame, ethnic

groups have migrated from their evolutionary regions. This raises several key issues associated with what is the optimum HCL baseline or even if there is just one HCL baseline for everyone.

As shown in Figure 1, the lighting community is in the process of radically narrowing the spectral range of our artificial lighting environment compared to what our cells have evolved under. This change has been driven by cost, technology, and energy savings but appears to not be supported by any health or wellness benefits.

Figure 1: The lighting community is in the process of radically narrowing the spectral range of our artificial lighting environment compared to what our cells have evolved under (Credits: Nick Spiker, www.nikespiker.com)

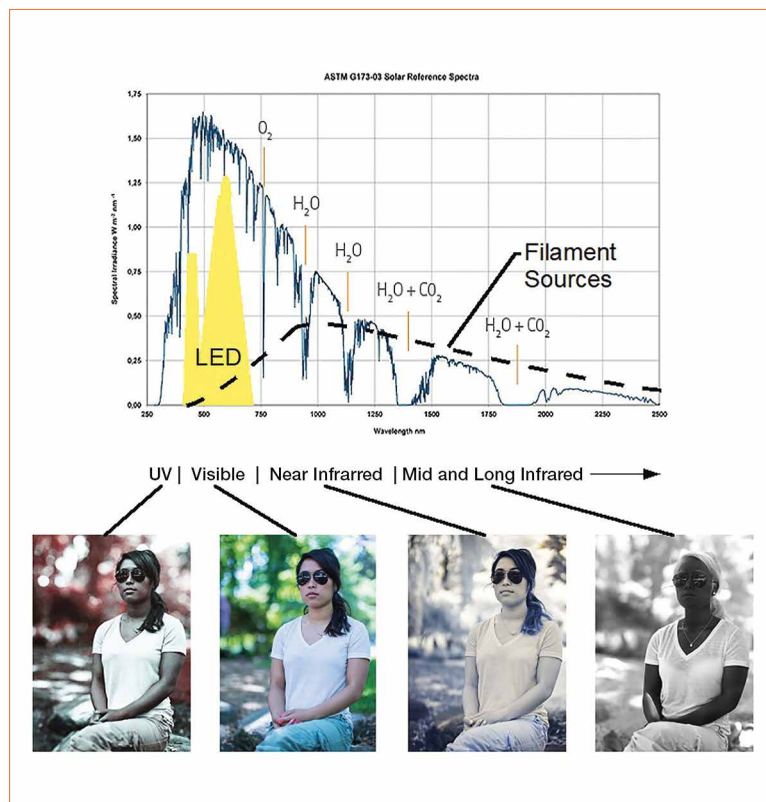

What HCL Baseline Should We Use?

The spectral reduction from the full spectrum of sunlight started 150 years ago with filament sources which provided copious amounts of NIR/IR but very little UV/blue content needed for melatonin stimulation. Fortunately, through most of this timeframe we were a substantially agrarian society with significant time in the sun. Over the last 40 years we have begun to shift to “Just Visible” (JV) lighting via fluorescent but with still significant NIR/IR from incandescent light sources in our homes. In the last 10 years we have begun a process that eliminates virtually all NIR/IR sources from our artificial lighting environment. This unfortunately coincides with energy saving NIR reflecting window treatments and skin cancer concerns reducing our time outdoors. As shown by the UV/VIS/NIR/IR pictures our bodies absorb and react very differently to each spectral region.

UV

UV spectral regions provide energy for Vitamin D production. On the other hand, highly energetic UV radiation UV can harm our tissues, destroy our genetic information, and cause cancer. Melanin is the dominate absorber providing protection against UV ionizing radiation and its associated skin cancer. - Fair skinned individuals with low melanin levels are 10 times more likely to develop skin cancer than dark skinned individuals.

VIS

Our visual system is limited to a range between about a little below 400 nm up to around 700 nm. This visible radiation is commonly called light, and the lighting industry is mostly focusing on it. This is characterized by the trend to offer light sources that only provide this “just visible spectrum” (JV lights). This radiation range, especially the highly energetic blue range, is also relevant for our photopic circadian cues. The blue range also affects our physiology and it may cause some damage in tissues.

NIR

The majority of the energy from the sun our bodies absorb is in the NIR. In this spectral region, melanin levels are dropping logarithmically allowing for penetration depths in excess of 1 inch into our body even through our skulls. Independent from their color, most organic materials (leaves, fabrics, and colorants) are almost equally transparent to NIR, respectively absorbing or scattering NIR, as shown in Figure 2.

IR

About 8% of the energy from the sun falls in the IR spectral region. This region is dominated by water absorption as melanin absorption approaches zero. In the IR we are all created equal (dark skin and white hair). While controversial and beyond the scope of this article, there is even evidence that both NIR and IR are fundamental to energy storage in the body.

About the Definition of Light

While light is strictly defined as those wavelengths to which our eyes respond, in the author’s opinion this definition is in part responsible for us missing the importance of UV/NIR/IR to our cells and HCL. For the purpose of this paper light will be used to refer to UV/VIS/NIR/IR radiation.

Proposed HCL Baseline

Three basic tenets are proposed for the HCL baseline:

- Minimum NIR/VIS ratio of greater than 1
- Zero flicker
- Lighting should adapt to skin pigmentation levels

In general, the common sense argument is that nature is opportunistic and that over millions of years our cells have evolved to take advantage of the 60% of the spectral energy our eyes don’t see. This argument is further justified by daylighting studies [1] indicating that sunlight is always superior both short term and long term to our existing artificial lights. Even further, the medical community is publishing over 400 peer reviewed papers per year on NIR treatments [2, 3, 4]. Ironically, at the same time, the lighting community is eliminating a major source of NIR/IR from our lives, the medical community is discovering that NIR can be used to treat everything from dementia to wrinkles. Sports teams are even using NIR treatments to increase athletic performance [5] with concern that its use should be banned from competitive sports [6].



Figure 2: The pictures demonstrate the differences in absorption and reflection of visible (VIS) radiation (left) and near infrared (NIR) radiation (right). - For comparison reasons both images are held in gray scales

Figure 3: The UV, VIS, NIR pictures show the differences in eye absorption. The sclera (white of the eye) strongly reflects VIS light but is 4 times more transmissive to NIR Credits: Nick Spiker, www.nikespiker.com) - For comparison reasons the images are unified to gray scales

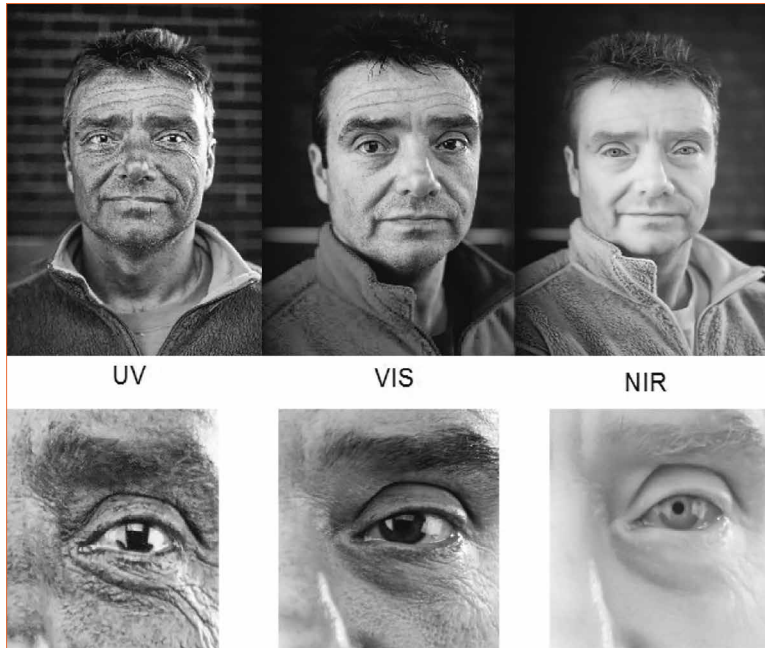

About flicker

Flicker is harmful and may even be a factor in rising dementia rates. While probably the most controversial tenet, flicker does not occur in nature and only exists to simplify drive electronics. Recent work at MIT indicates that pulsed light impacts plaque formation as it relates to dementia [11]. It is also generally accepted that a significant percentage of the ASD population is sensitive to flicker [12].

Light and skin pigmentation

Prior to recent migrations, skin pigmentation evolved solely based on latitude and foliage conditions. As shown in Figure 4, this evolutionary adaptation leads to huge differences in how NIR light is absorbed in the human body. It is doubtful that a single optimum HCL baseline exists for all ethnic groups and, in fact, it could be argued that certain ethnic groups are being disadvantaged by our JV lighting approach. Given that we are latitude mobile, it would appear that an optimum HCL baseline needs to adapt to the skin pigmentation of the individual.

Figure 4: Lambda Research TracePro model of the differences how NIR light is absorbed in the human body. NIR uniquely penetrates over an inch into our body (even our skull) reducing inflammation, enhancing cognitive skills, and stimulating muscle strength

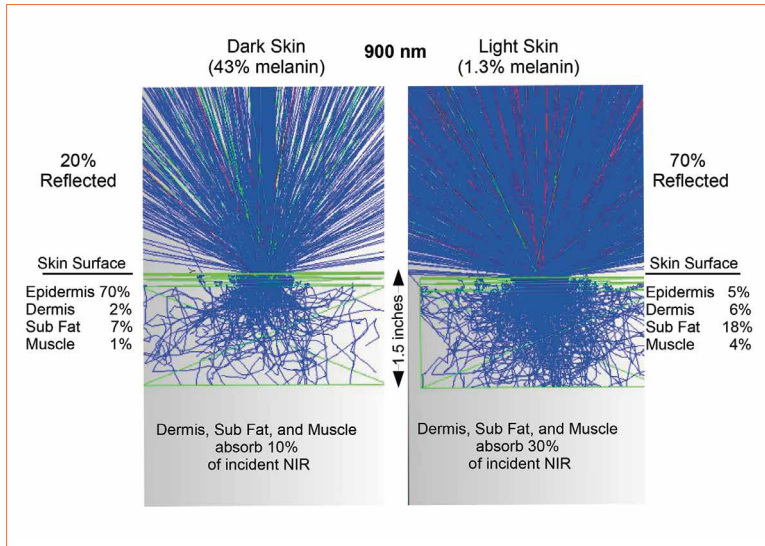

In some ways the lighting and medical communities seem to be headed in opposite directions.

The three basic tenets are derived from three observations.

The NIR/VIS ratio

All natural light sources have NIR/VIS ratios greater than 1:

- The NIR/VIS ratio for the sun ranges from 1 (midday) to 5 (sunrise/sunset)
- Moonlight is around 2 and
- Fire ranges from 5 to 10

1000s of medical articles indicate that NIR functions to protect and repair our cells via stimulation of

ATP production in our mitochondria [7]. There also exists new water research [8] which indicates NIR/IR may be fundamental to energy storage at a cellular level. Interestingly, there exists between 700 and 1000 nm a biological window [9] in which absorption is at a minimum. This allows NIR to penetrate over an inch into our bodies even through our skull. The majority of our cells only “see” NIR wavelengths. NIR is, for example, strongly absorbed by our blood but very weakly absorbed by the other surrounding tissue making the blood vessel visible in the NIR not apparent in the VIS. Also sclera transmission and absorption varies depending on the spectral range (Figure 3).

Coincidence or Critical Issue?

African Americans have the highest dementia death rate (80/100,000) in the world nearly twice that of their white American counterparts [13]. This is contrasted with black populations at the equator having some of the lowest dementia death rates (1/100,000) [14]. 90% of lighting in the Soviet bloc until recently was incandescent “Ilyvich” bulbs unlike the US and Europe. Dementia death rates in Russia are (2/100,000) while Finland dementia death rates are (53/100,000) [14]. Myopia rates are skyrocketing especially in Asian countries which predominately use JV LED lighting [15]. Horticulture lighting is adding NIR to enhance growth rates [16]. Non VIS circadian cues are being proposed [17]. Macular degeneration is being treated with NIR [18].

While the exact root causes for above are unknown, it is reasonable to think that lighting plays some role. But why is it so hard to establish a HCL baseline?

The Need for a HCL Baseline Studies

Unlike plants, it is difficult to accurately assess the impact of light on humans as we move around and live a wide range of lifestyles. Given that natural sunlight delivers up to 60 MJ/day of UV/VIS/NIR/IR onto a typical human body and that an incandescent lamp can locally deliver even higher NIR exposure levels when we sit down to read a book, simple variations in lifestyle can significantly impact light exposure studies. In general, there is a lack of long term research which takes into account the total light exposure of the participants on a daily, weekly, and monthly basis. Added to this lack of controlled studies, the medical community is motivated to develop treatments which can be done within the time constraints of an office visit, while the lighting community is motivated to limit the spectral range as much as possible to save energy. Neither of those two motivations are helpful in determining what the optimum HCL baseline should be.

Proposed Solution - Measure and Simplify Lighting

The proposed solution consists of two parts.

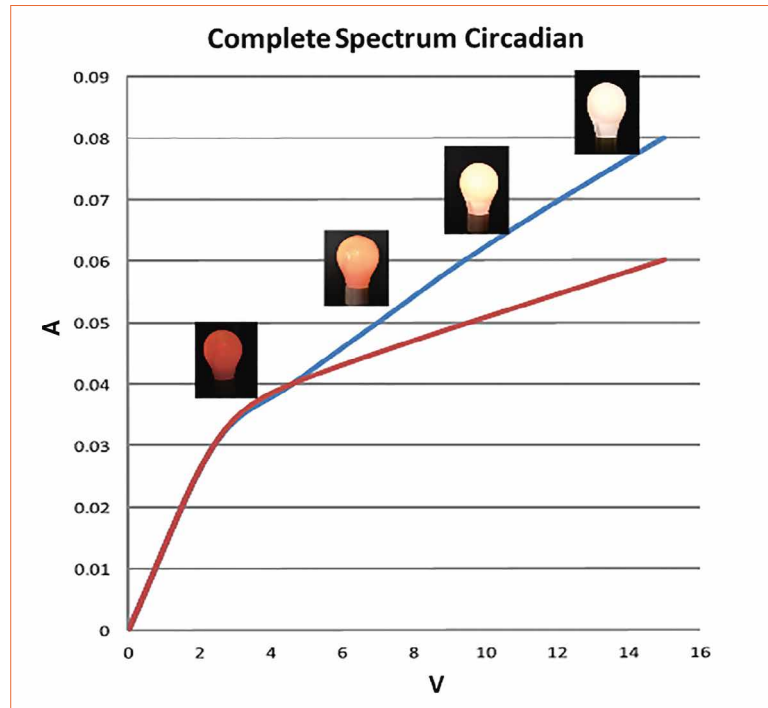

Figure 5: NIR enhanced LED lighting source that mimics both the intensity and spectral shifts of the sun

The two proposals:

- Daily, weekly, monthly UV/VIS/NIR exposures levels tracking
- Adopt NIR enhanced LED lighting that mimics the complete circadian spectrum without the need for complex drivers.

office have LED or fluorescent lighting, do the windows have NIR reflecting coatings, what are you wearing (e.g NIR transmitting clothing), etc. can be used to further refine the accuracy of the monitoring. With the introduction of NIR cameras in cellphones it is now possible to directly measure UV/VIS/NIR levels and input the data into the app. In general, the purpose of the app is to expand the spectral range we "see", so we can make appropriate lifestyle changes.

Light exposure tracking

An app can accumulate daily, weekly, and monthly exposure data based on the location, time of day, and weather conditions.

While an estimate, there exists a wealth of information that can be accessed from a mobile device. This combined with some individual responses regarding; does your

NIR enhanced LED lighting

Figure 5 depicts a NIR enhanced LED lighting source that mimics both the intensity and spectral shifts

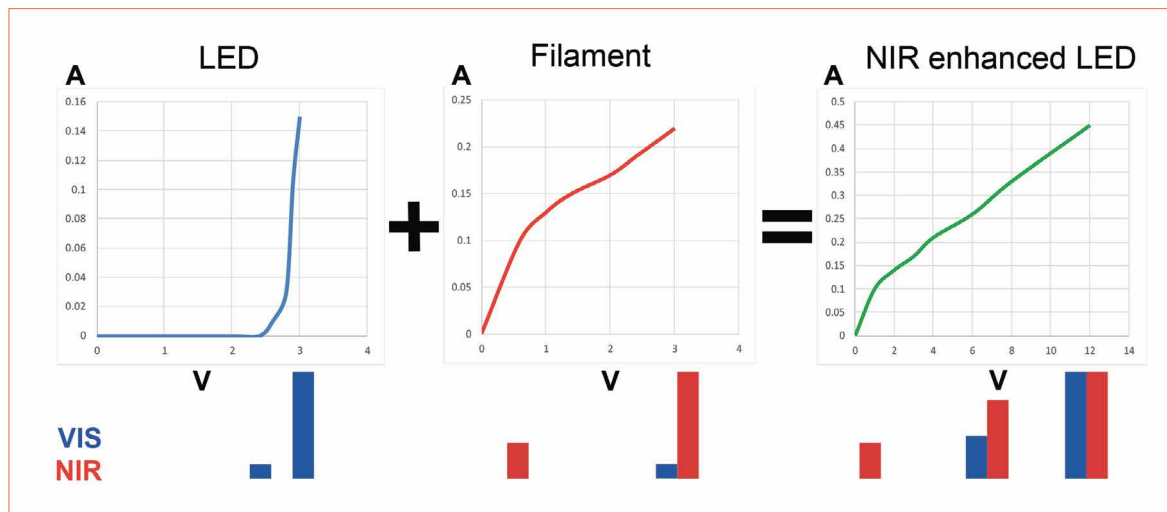

Figure 6: U/I diagrams for an LED, an Incandescent and a combined light source

of the sun (Complete Spectrum Circadian™) simply by adjusting the input voltage. The system can be scaled to any lumen level and the ratio of NIR/VIS can be adjusted for individual preference or skin pigmentation levels.

The system is based three components; a novel CNT Yarn LED package and 2 wire terminal filament sources. The filament sources are non-linear resistors used to eliminate the need for complex constant current drivers as shown in Figure 6.

Low temperature filament sources are the longest living man-made light source known (Century bulb) and are 90% efficient at generating NIR/IR light. From room temperature to operating temperature a filament source increases its resistance tenfold. A patent pending series/parallel design is used to create the spectral and intensity IV response which mimics the sun simply by adjusting the voltage from zero to peak voltage (0-15 V in the example from figure 5). This eliminates the need for constant current drivers and flicker associated with PWM dimming methods. The technique can be used for both DC and AC inputs and scaled to any lumen output level. However based on the previous flicker discussion it is proposed that this solution should be used as a catalyst to push DC lighting solutions.

The author is keenly aware of the heresy associated with bringing filament sources back into lighting. While the use of current limiting resistors with LEDs are common place, the idea that a couple of grain of rice filament sources could be used with an LED to eliminate complex drive electronics and provide beneficial NIR/IR light is somehow taken as a step backwards.

While the IP covers a host of means of creating NIR enhanced LED lighting including NIR phosphors, NIR LEDs/LD/VCSELs, and quantum dot converters, this filament configuration is the most efficient, cheapest, greenest, longest life expectancy, broadband, and the simplest HCL solution. The life expectancy of small filament sources exceeds 300,000 hours when they are not required to generate significant blue/green light. They do however provide significant orange and red even at these low drive levels to the benefit of color quality while they generate copious amounts of NIR. By combining two competitive technologies both technologies benefit.

The majority of the resistance change in filament sources occurs at lower drive levels. By matching the filament resistance curves with the LED IV curves it is possible to eliminate the need for constant current drivers. Given that the

filament sources are 90% efficient at generating NIR most of the energy consumed is used by the LEDs (only 40% to 50% efficient) at peak drive levels depending on what NIR/VIS ratio is selected. Using this approach, 80 to 100 lm/W source efficiencies are possible with NIR/VIS greater than 1. The reduced raw material costs, health benefits, higher reliability, and cost savings associated with simpler drive electronics offset any energy penalty incurred by adding NIR back into our lives.

As stated earlier the filament sources are 90% efficient and have longer life expectancy than the LEDs. At these low drive levels the only significant thermal load on the LEDs from the filament sources is via radiation coupling which represent only a fraction of the light emitted by the filament and can be easily minimized via placement or shrouding. Unlike incandescent and halogen sources of the past, the function of the filament sources in these design are only required to match the VIS optical watts outputted by the LEDs. At 90% efficiency a small T1 filament bulb run at 80% drive level can output more NIR optical watts than the VIS optical watts generated by a 300 lumen JV LED bulb.

To improve the LED reliability, a novel interconnect method was developed. Using CNT Yarns a

Figure 7:
Structure of
the proposed
LED+Filament
light source

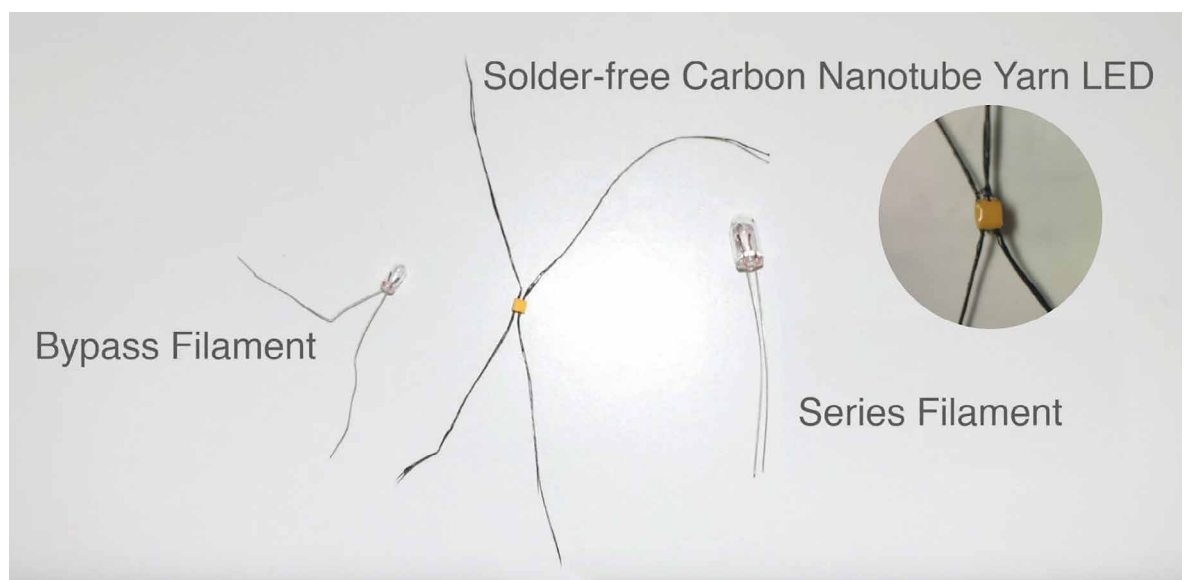

New Cube Power™ Dynamic COBs

UNIFORM • EFFICIENT • EASY TO IMPLEMENT



Luminus introduces CCT adjustable light sources for directional lighting in hospitality, retail, and residential applications.

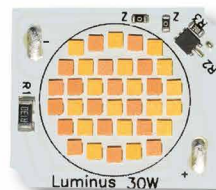

- CCT Tunable COBs
1800K to 4000K
2700K to 6500K
- Warm Dimming COBs
3000K to 1800K
4000K to 2700K

RESTAURANT

RETAIL

OFFICE

RESIDENTIAL

MEDICAL

ENTERTAINMENT

AEROSPACE

3D PRINTING

PROJECTION

dual sided CSP emitter can be formed. Unlike conventional solder based connections, the gold/CNT contacts are glued together using a high temperature rigid silicone rated to 600°C. CNT Yarns are inherently “sticky” due to the large surface area created by millions of fibers making up the yarns. In this design the CNT Yarn serves as both the electrical and thermal conductors. Two Seoul Semiconductor CSP die are bonded back to back as shown in Figure 7.

By using CNT Yarn instead of metal wire and solder, failures associated with electromigration are eliminated and a wide range of mounting configurations can be used. Typically filament sources and CNT Yarn LED packages are simply crimped or tied together. Additional cooling surface area can be attached as needed. The lumen output can be scaled either by using additional groups or by using high wattage components. In both cases, peak drive levels on the filaments are maintained at low levels such that the product lifetime is defined by the LEDs not the filaments. This design approach uses the minimum raw materials

possible, contains no red listed materials, and is compatible with cradle to cradle.

NIR Enhanced LED Lighting offers a practical, common sense solution that complements all daylighting efforts. We have a very limited knowledge of how light interacts with our cells, but the deeper we look the more we find that light plays a significant role in our health. Lighting should follow the medical community’s lead and adopt a “first do no harm” philosophy. As the data from the app becomes available we may be able to limit the spectrum for some individuals. Until that time the daylighting studies and medical research would seem to indicate that we should mandate that all artificial lighting we are spending significant time under have a minimum NIR/VIS ratio of greater than 1.

Conclusion

For millions of years our cells have received a specific spectral and temporal exposure. It is naive to think that nature has not developed mechanisms that take advantage of this exposure and recent medical

data appears to support this position. For the last 150 years we have been removing spectral content from our lighting. Recent government action, lifestyle changes, skin cancer concerns, and the blind pursuit of energy savings will eliminate over 70% of the solar spectrum from our lives over the next decade. There appears however to be no data which supports reducing the spectral range yet numerous indications to the contrary. The medical community appears to be headed in the opposite direction of the lighting community showing the NIR/IR light benefits the body and can even be used to treat ailments using energy exposure levels similar to those possible in lighting systems. There exist practical, energy efficient, and lower cost solutions that don’t require us to compromise. At this point, standards and government programs represent the most significant hurdle to HCL. It is proposed that the NIR enhanced LED Lighting is consistent with daylighting efforts in the architectural community and should be mandated for areas in which there is long term exposure. ■

References:

- [1] <http://www.wseas.us/e-library/conferences/2013/Malaysia/MACMESE/MACMESE-20.pdf>
- [2] <http://valtus.blogspot.fi/2017/05/the-therapeutic-effects-of-red-and-near.html>
- [3] <https://www.sciencedirect.com/science/article/pii/S1011134415300713>
- [4] <https://www.ncbi.nlm.nih.gov/pmc/articles/PMC4768515/>
- [5] <https://link.springer.com/article/10.1007/s10103-016-2139-9?no-access=true>
- [6] <https://www.readbyqxd.com/read/27874264/photobiomodulation-in-human-muscle-tissue-an-advantage-in-sports-performance>
- [7] <http://photobiology.info/Hamblin.html>
- [8] <https://www.bing.com/videos/search?q=pollack+4th+phase+of+water+ted&view=detail&mid=DDB895A8CAC1B45D90C3DDB895A8CAC1B45D90C3&FORM=VIRE>
- [9] <https://www.quora.com/Can-near-infrared-NIR-light-penetrate-the-human-body>
- [10] <http://www.montana.edu/jshaw/documents/NIR%20Photography%20-%20Mangold%20et%20al%20-%20EJP2013.pdf>
- [11] <https://science.mit.edu/news/unique-visual-stimulation-may-be-new-treatment-alzheimer%E2%80%99s>
- [12] <http://krex.k-state.edu/dspace/handle/2097/6915>
- [13] https://www.alz.org/national/documents/report_africanamericanssilenteidemic.pdf
- [14] <http://www.worldlifeexpectancy.com/cause-of-death/alzheimers-dementia/by-country/>
- [15] <https://www.npr.org/sections/goatsandsoda/2015/02/05/383765377/why-is-nearsightedness-skyrocketing-among-chinese-youth>
- [16] <https://www.scribd.com/doc/178722716/nir-and-plants-2013>
- [17] <https://www.photonicsonline.com/doc/ultrafast-pulses-modulate-circadian-rhythm-and-blues-0001>
- [18] <https://www.ncbi.nlm.nih.gov/pmc/articles/PMC4768515/>

In control...

Future Lighting Solutions'
Philips Lighting
zero lead-time initiative
gives you the confidence
of knowing parts are
ALWAYS IN STOCK

2018 LIGHTFAIR International
May 6 – 10, 2018
McCormick Place
Chicago, IL USA
Booth #837

 **FUTURE**
Lighting Solutions
Making LED Lighting Solutions Simple™



www.FutureLightingSolutions.com/ZeroLT

*Offer is based on certain marketplace assumptions and, as such, changes in the marketplace may invalidate this offer. Offer may end at Future Lighting Solutions' discretion at any time. Offer is valid in North America only. Please contact your local Future Lighting Solutions representative or visit www.FutureLightingSolutions.com/ZeroLT for details on this offer and its terms and conditions.

Electrical Over Stress - How to Prevent an LED Failing Earlier than Expected

While LEDs are, in general, very robust, failures still happen due to electrical over stress. Mauro Ceresa, EMEA Field Application Engineer Manager at Cree, will cover all aspects related to electrical over stress, or when an LED fails due to being subjected to a voltage beyond its specification limits. He will explain why the failure occurs and how to prevent this from happening. The article will explain the fundamental aspects of a good PCB layout design and how this is linked to the longevity of an LED.

Solid state light technology has become an important player in the lighting industry thanks to the many performance advantages that LEDs offer. The performance enhancements of this rising star technology - its efficiency advantages in particular - have led to many new applications and the widespread adoption of LED.

Solid state light usage proliferation exposes LEDs to a range of new and harsh working conditions, and demonstrates that their theoretical "great longevity" could easily be compromised by various environmental factors. Chemical incompatibility is one of the first issues customers face, but luckily, in most cases, this problem tends to become apparent quite rapidly when caused by a fixture design fault.

The speed at which these faults become evident means that the industry is becoming increasingly conscious that the expected lifetime of LEDs could be seriously compromised if they are exposed to volatile substances incompatible with solid state light constructing

materials. Unfortunately, not all threats to LEDs are evident enough so as to enable users to take the necessary steps to fix the issue before a massive field failure occurs.

The most critical threat comes from the same source that powers the LEDs, and is known as "Electrical Over Stress" (EOS). An EOS occurs every time the LED driving current or voltage exceeds the component maximum rated values. There are many different types of EOS - some are generated during the LED assembling or testing process, while others are produced by the power supply or come from the environment induced by the electromagnetic field.

An EOS is the most dangerous threat for solid state light technology because it uses the same path used to light up the LED. In addition, the damage it causes is often not immediate. In many cases, the LED may only cease to work days or even months after installation. These two characteristics of an EOS mean it can be incredibly difficult to prevent,

and expensive to solve. The time lapse between the EOS occurring and the failure to detect the fault can be quite long and have serious repercussions as more luminaires may be produced and installed, thereby increasing the cost of warranty replacement.

Why an Electrical Over Stress Happens

There are many different reasons and ways in which an EOS could happen, but there is only one result: LED failure. EOS damages the LED chip structure which causes it to fail faster than its expected lifetime.

An EOS is caused by external sources like the working environment, a test procedure or human interaction, as well as an internal interaction like bad or wrong power supply, PCB design layout, or faulty components that generate a voltage or current across the LEDs exceeding the maximum voltage rated in the datasheet.

When the voltage or current exceeds the component maximum rated values, this is called “stress”. To better understand why an EOS happens – in both an open or short circuit - and the time it will take for the LED to fail, it’s important to consider the energy content of the stress. Every time a stress is applied to a solid-state light product, it creates a voltage and a current which flow through the entire circuit impedance (fixture plus environment). This means a certain power stress is applied to the LEDs.

If the power stress signal is integrated, over time the energy stress will be measured in Joule. Low energy stress generates insignificant damage - or sometimes none at all - while mid-energy stress damages the LED, but failure will only occur a long time afterwards. On the other hand, high energy stress immediately causes the LED to break either by blowing up the wire bonds, or melting the die attached to the solder pads.

It’s important to note that even without a failure after a stress, this does not mean the LED is not damaged. Low and mid energy stresses could lead to micro damages (Figure 1) that are not instantly visible (Figure 3), but these can end in catastrophic failure after a number of working hours. That is why every LED that is exposed to

an electrical over stress should be considered a device at risk of failure.

Different Types of Electrical Over Stress and How to Prevent Failures

There are many possible sources of EOS that could be generated by fixture design issues, human error and even by the limitations of regulations in place before the solid-state light technology broke into the lighting industry.

The following will cover all the potential circumstances that can cause an EOS, and provide guidance and recommendations to prevent field problems. In some cases, the solutions are strongly influenced by customer design, which is why it is essential for LED manufacturers to work closely with customers to ensure their fixture designs are EOS-proof.

Electrostatic discharge

The first possible source of EOS is generated by operators handling the LED or printed circuit boards. This type of EOS is generated by the Electro Static Discharge (ESD). An ESD is a low-energy event with a very short duration – it only lasts a few microseconds. An ESD is typically generated in non ESD protected working environments. For instance, the operator body could have a very different electrical potential from the LED board, and when they come into contact with LEDs, an ESD can occur.

Typically however, ESDs are not a problem for LEDs because the majority of LEDs are equipped with an ESD suppressor which protects the LED chip. Nevertheless, some very small new LEDs which are designed to maximize light density, are not equipped with ESD suppressors, which is why an external ESD suppressor must be used. These additional components have to be positioned very closely to the LED to protect it properly. These ESD suppressors have been used for decades to protect other

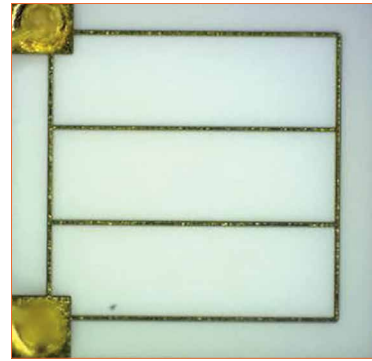

Figure 1: Low and mid energy stress generate a long term short circuit failure due to micro damages

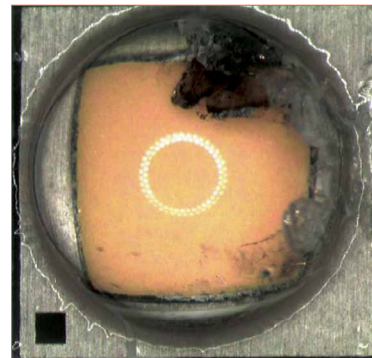

Figure 2: High energy creates an immediate failure in open circuit

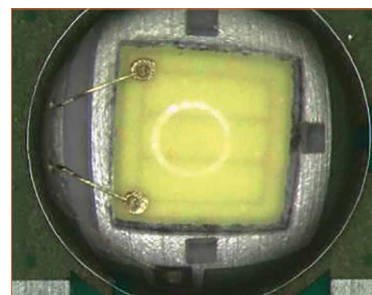

Figure 3: LED with invisible micro damages

electronic devices, and can be used to solve this possible EOS issue if needed.

Power supply

Another possible source of electrical over stress comes from the power supply used in the luminaire. There are several possible conditions that could damage the LEDs even in the absence of any misoperation by the user. Every time a new constant current power supply is selected, it is mandatory to check output tolerances, current ripple, transient spikes during the switch on and off phase and finally, the hot plug current. Tolerances, ripple and spikes could be silent LED killers that are compromising the component integrity without any obvious sign. Figure 4 shows a commercial constant current 1050 mA power supply, representing many possible sources of EOS.

Figure 4:
Ripple of a commercial constant current 1050 mA power supply, representing many possible sources of EOS

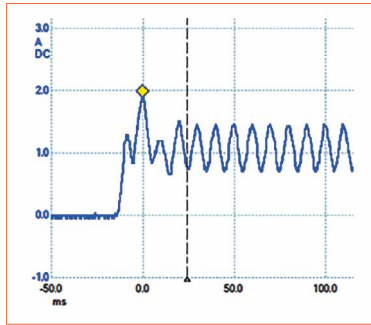

First and foremost, every time a solid-state light fixture is switched on, this power supply generates a spike of 2 A per few milliseconds. If the LED type used here is rated 2 A or more, there shouldn't be a problem. However, if the devices used have a maximum rated current of 1.2 A, on a constant current 1.05A power supply, one could be running a big risk.

If the fixture will be switched on and off once or twice a day, the LED will most probably last as long as expected. However, in cases where a presence or movement sensor turns our fixture on and off, the many spikes per hour will stress our LED, thereby compromising its lifetime.

Another critical aspect of this power supply is the ripple. Here, there is approximately $\pm 40\%$ of ripple. Beyond a few potential unpleasant effects, like flickering and flux reduction, this ripple could force the LED to work out of specification and under stress for continuous, repetitive cycles.

Figure 5:
The “hot plug current peak” test represents the possible overstress and the probability of LED damage induced by a misoperation can be estimated

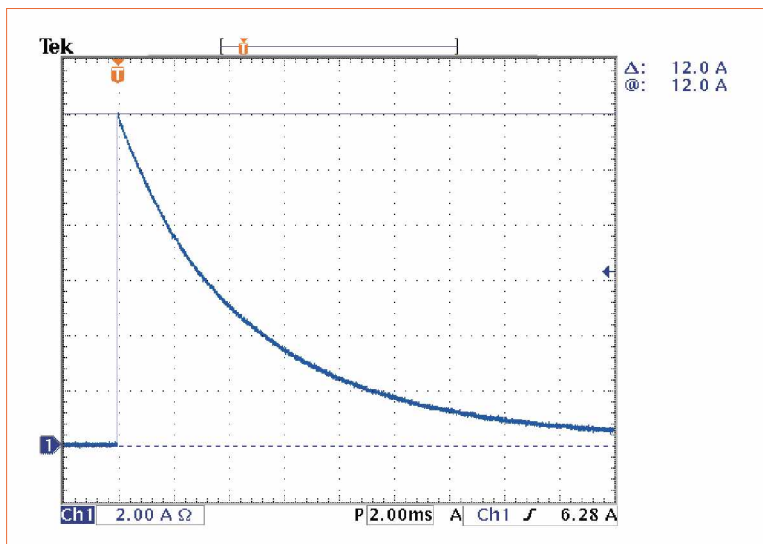

As discussed previously, if using a 2 A or higher rated current LED type, nothing will happen. However, with a 1.2 A maximum current device, the LED lifetime will be seriously compromised by the constant current power supply. It is also essential to consider the tolerance of the average current output, which can worsen the situation, by increasing all these values by the tolerance percentage.

To prevent EOS failure in the scenarios described above, it's important to use power supplies with a limited transient peak during the switch on and off phase. These power supplies must not exceed the maximum rated current of the LED. Moreover, the typical current combined with the ripple and the positive tolerance must not exceed the maximum LED rated current. If all these conditions are respected, the power supply will not lead to any EOS.

Another possible source of failure is the reverse polarity connection of the power supply, or negative pulses. If an operator swaps the polarity during the test or production phase, the LED will be seriously damaged by this EOS. To prevent this from happening, it is good practice to use power supply with short circuit protection and equip the LED board with a diode in parallel to the LED string in reverse polarity. If the power supply is connected to the LED board with

a connector, a polarized connector is the best solution.

One last test - which is always good to run - it is a “destructive test” on few LED boards to measure the hot plug current. This test consists of switching on the power supply (without connecting any LEDs) and then hot plug to the LED board. By doing this, the hot plug current peak can be measured (Figure 5) that represents the possible electrical over stress in case of bad or wrong electrical contact during the luminaire assembly or test. The peak as seen on Figure 5 is proportional to the difference between the power supply maximum voltage output without load, and the total forward voltage of the LED string. This means that the higher the gap, the higher the probability of LED damage induced by a misoperation or bad electrical contact.

To prevent EOS failures induced by the hot plug current, it is important to follow assembly procedures that exclude potential hot plug scenarios and choose appropriate power supply and connectors.

During the assembly process, the power supply must not be plugged into the electricity before the LED board is firmly connected. Moreover, the LED board must not be disconnected from the power supply before the power supply has been turned off. Using a power supply with a built-in current limiter would also make the assembly operation safer, while also preventing any potential human error.

Finally, connector quality is crucial. Poor quality connectors with a loose electrical contact, act as a hot plug - even if the board is electrically connected to the power supply. Generally, if the LED produces flashes or blink light, a current pulse is likely to be behind it, which could be a sign of an EOS and will require further looking into. By following these simple rules, any possible EOS during the assembly operations can be avoided.

Lighting the World ONE LED AT A TIME

NICHIA launches Ultra High CRI, Optisolis™,
raising the bar for white LEDs.

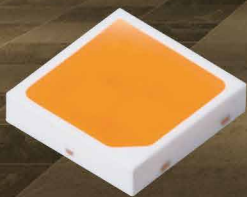

757 Series
Ultra-High CRI

Optisolis™

- No UV emission
- Full spectrum close to natural sunlight
- Less disruptive circadian rhythm
- High color fidelity (Rf)
- Full color gamut (Rg)

2018 LIGHTFAIR International
May 6 – 10, 2018
McCormick Place
Chicago, IL USA
Booth #837

Request Your FREE Samples Now!
www.bit.ly/FLSNichiaSamples



www.NICHIA.com



FUTURE
Lighting Solutions
Making LED Lighting Solutions Simple™

www.FutureLightingSolutions.com

Figure 6:
Badly designed
Transient Voltage
Suppressor that never
protects the LED as it
does not cross the
LED curves

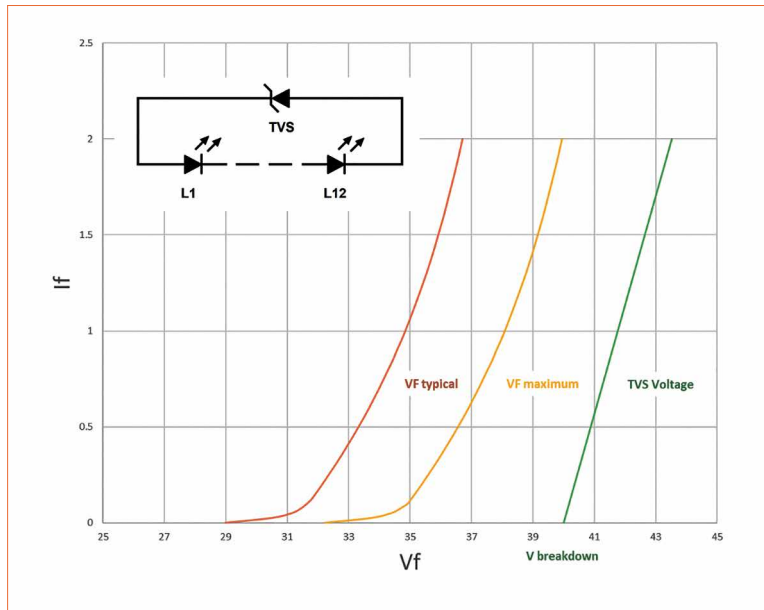

Tests

Other potential production operation issues that can generate electrical over stress include in-circuit and laboratory tests. These tests present a high potential for EOS – and hot plug EOS in particular.

In-circuit tests tend to be automated processes and can be useful when done properly. In order to avoid the risk of EOS, it is essential that the machine software carrying out the test is programmed to follow this step-by-step process: First and foremost, connect the probes; apply the energy to the test circuit; remove the energy from the circuit and finally, remove the probes contact. By following this process, the driving circuit will successfully test the LED without causing any damage.

In order to ensure that a software bug does not damage the LED, the best option is to use a constant voltage source with a resistor in series to limit the test current. This type of test cannot be conducted when measuring the LED flux, CCT and Vf, as the forward voltage variation from LED to LED could influence these parameters. In all the other cases however, it is a very safe way to in-circuit test LEDs.

Laboratory tests are more critical, as boards are usually tested manually and the potential for

human error is very high. In some cases, constant current power supply is used, while in others, laboratory power supply with current limiters is the preferred customer choice - both of which are very dangerous. In the case of constant current power supply, if the sequence is not done every time perfectly the LED will be damaged, whereas in the second case, there are a number of variants that could damage the LEDs.

When using constant current power supply, it is recommended to put two push buttons on the cord that connect the power supply to the plug. By doing this any operator - even an untrained operator - will be forced to connect first the LED board to the power supply and then push down the two buttons.

Even if the power supply is plugged in, the primary stage is not electrified by the two push buttons that are opening the circuit. It would be possible to run this test with just one button, but installing a second saves the operator from pushing the button while simultaneously connecting the board with the other, and just ensures a safer process.

When using laboratory power supply with a current limiter, there are two main risks – the first being simply that someone might involuntary move one of the knobs, causing the

LED to stress due to the change of setting. The second risk lies in that the power supply is constantly running, and the output stage is energized and if the current limiter circuit is positioned before the output capacitors, the current limiter will begin working once the LEDs are already damaged. Despite this being perceived as a very safe LED test mode, it is not.

Field hot-plug and long cables

But solid-state light fixtures are not designed to just be kept in warehouses, and many EOS risks exist beyond the production phase. This is why technicians aim to anticipate potential EOS triggers once a fixture is installed. For outdoor applications, this means considering different weather conditions and electromagnetic fields, as well as on/off cycles and other induced magnetic fields for indoor applications.

Today, the majority of LED fixtures are equipped with an on-board driver which protects against hot-plugging during the installation phase. In the early LED adoption era, the three LED MR16 lamps were destroyed during the installation phase by hot-plugging. Having the driver on board or together in the fixture housing also prevents EOS caused by the long cables that connect the LED boards to the power supply, and act like antennae. They connect all the electromagnetic fields produced by radio systems, lift motors, etc.

In some cases, customers position a Transient Voltage Suppressor (TVS) on the LED board to prevent this type of EOS and hot plugs, but this is not effective for two reasons. Firstly, these EOS are high frequency signals that bypass these suppressors, and secondly, the electrical characteristics of the LED and the TVS do not match.

Figure 6 shows a series of 12 LED “typical” and “maximum” forward voltage. The TVS should be selected

guangzhou international lighting exhibition

23rd

The most influential and comprehensive lighting
and LED event in Asia

9 – 12 June 2018

China Import and Export Fair Complex
Guangzhou, China

www.light.messefrankfurt.com.cn

Contact

Messe Frankfurt (HK) Ltd

Tel: +852 2238 9969

Fax: +852 2519 6079

light@china.messefrankfurt.com



光亞 · Guang ya



messe frankfurt

Figure 7:
If any of the creepage distances or the PCB breakdown voltage is not sufficient, the risk for damage by an EOS is very high

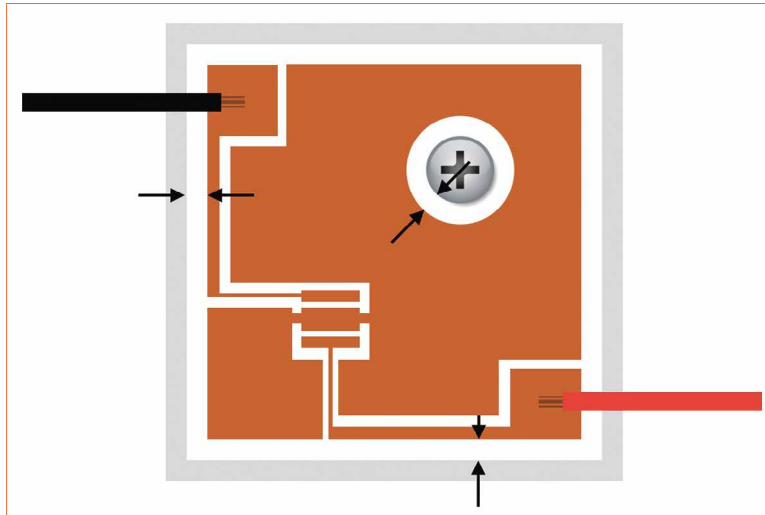

with a minimum breakdown voltage greater than the maximum LED forward voltage at the maximum driving condition. This is essential because the TVS parallel to the LED string must not absorb any power in standard working conditions. In Figure 6, the green TVS curve never crosses the LED curves, which means that the TVS will never protect the LED. Instead, the LED absorbs the entire EOD.

We will explore in detail how to design a circuit to protect against common mode or differential mode EOS, but first the best PCB design will be discussed.

PCB design

To avoid any potential dangerous conductive path between the fixture housing or heat sink and the LED pads, it is very important that the Printed Circuit Board (PCB) be designed to keep an appropriate creepage distance from the copper pads and the edges of other metal parts connected to the housing.

In Figure 7, any copper path close to the edge must be kept over the insulation distance. The minimum suggested distance is 3 mm, even though the recommended distance is generally anything from 5-7 mm when feasible.

Another critical consideration of PCB design are the copper traces close to the screws. The distance must be calculated considering the

screw head diameter and not the PCB hole. When wires are fused on the PCB instead of using the connector, it's very important that the cable wire insulation covers the soldering pad and does not reduce the creepage distance.

PCB used for LED boards is typically aluminum-based. The aluminum and copper are separated by a dielectric material that provides the electrical insulation between both metals. This dielectric should be thin enough to guarantee a good thermal transfer from the LED to the fixture housing, but thick enough to provide sufficient electrical insulation. Normally the PCB aluminum is in direct contact with the fixture heat sink, so the unique insulation is guaranteed by the PCB dielectric. For this reason, it is crucial that the PCB vendor guarantee the minimum value of the PCB breakdown voltage for all the PCB supplied.

If any of the creepage distances or the PCB breakdown voltage is not sufficient to withstand the environment surges, there is a risk that electrical arches and discharges will occur and the LED will be stressed and damaged by an EOS (Figure 7).

Common and differential mode surge

Most LED users will probably be familiar with the scenarios outlined above. Before exploring further

situations causing EOS, it's important to understand industry regulation and protection classes.

The International Electrotechnical Commission (IEC) and the IEC61140:2016 define the rules of protection for people against electric shock. Depending of the country and the type of product, there are different insulation level requirements for the devices sold in each market.

The most commonly-used insulation classifications are Class I and Class II. Class I fixtures must have their housing connected to the electrical earth with a dedicated cable. Class II fixtures on the other hand, are designed to provide the required level of safety without any electrical earth connection.

| Protection Classes Symbols | |
|----------------------------|----------|
| Class I | Class II |
| | |

These two different classifications make the solid-state light fixture behave in a completely different way when exposed to environmental stresses. In general, if the electrical earth connection is done in an effective and reliable way, the Class I luminaries suffer less from EOS failure but in reality, both luminaire types need to be designed efficiently to prevent EOS damage.

Another crucial regulation to consider is the IEC60598-1:2014 that defines the general requirements and tests for luminaries, including the solid-state light fixtures. This 2014 edition replaced the 2008 version, and provides a relevant change for Class II products.

Paragraph 10; Section 4 of IEC60598-1:2014 on "Construction", addresses the double insulation Class II luminaires. Sub-paragraph

4 (IV.10.4) of the chapter specifies the protective impedance device, stating that accessible conductive parts separated by double insulation may act as a conductive bridge using resistors or Y2 capacitors. They need to consist of at least two separate components of the same rated value.

These components must comply with appropriate IEC regulation. With Class II luminaires, it is possible to add specific components connecting LED boards to the fixture body. This makes it possible to analyze what the LED circuit looks like during fast transient stress. Figure 8 shows two LEDs in series with a simple model that shows the LED and the ESD protector built-in in their package.

This model does not consider all the parasitic components or the influence of the LED thermal pad. The thermal pad is a vital pad that allows the LED to efficiently transfer the heat from the source (junction) to the air via many metal parts.

For a very good thermal transfer, the thermal pad should be connected to a very large copper area on PCB. This spreads the heat horizontally and then efficiently transfers it vertically to the aluminum layer of the PCB, thanks to the large transfer area. Two metals separated by an insulator create a capacitor, which means that PCBs are capacitors that should be considered in this particular analysis. This parasitic capacitance could be big or small depending on the PCB design and the material used. It cannot be ignored and it is important to understand how to manage it in order to avoid EOS problems.

LED and TVS could be modeled in very complex way, and for people who enjoy spending hours in simulations, this is a great way to have fun. For the purpose of this paper, just a simplified model with the capacitor connected electronically in parallel to the other components is used, as illustrated in Figure 9.

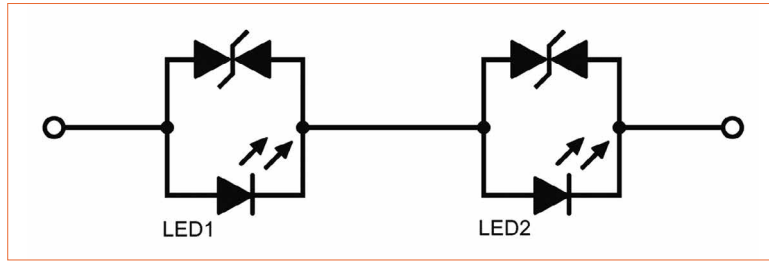

Figure 8:
A simple model of two LEDs in series with an ESD protector

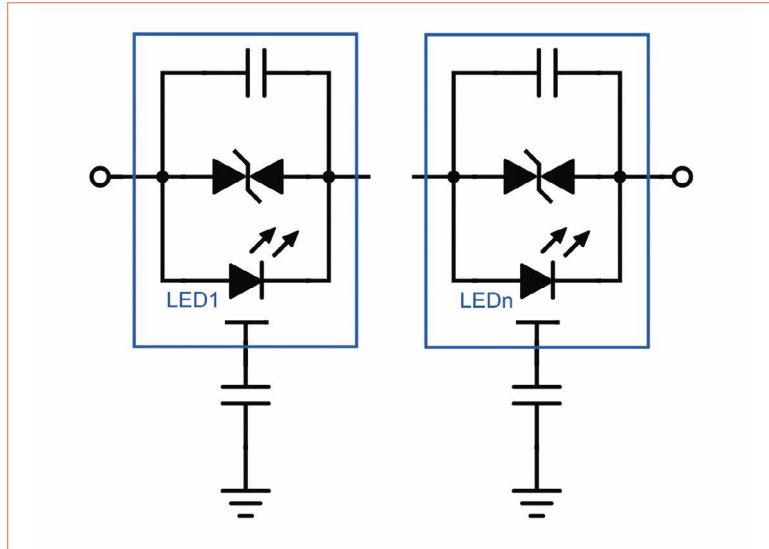

Figure 9:
Simplified model of an LED and TVS with a capacitor

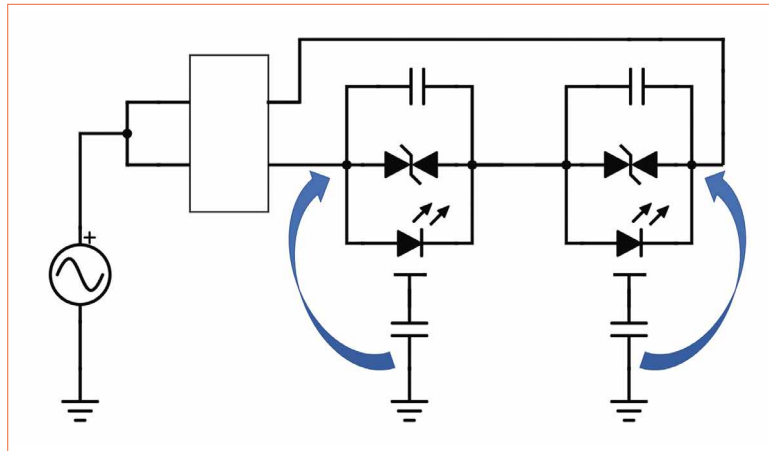

Figure 10:
Leaving LED and TVS floating is a relatively unsafe option

Because of the parasitic capacitance between each thermal pad to the ground, it's important to understand how to connect them. There are two options: Leave them separate or connect them.

There is also the option to leave them electrically floating or to connect them to an electrical voltage potential. Leaving them floating is a relatively unsafe option, as any common mode stress is applied directly between the thermal pad and the LED electrical pads - anode and cathode. This creates a fatal EOS as soon as the voltage drop between the points marked

by the blue arrows (Figure 10), exceed the LED package insulation.

With regards to the LED package material, ceramic provides much better insulation than plastic, and depending on the distances between pads, it's possible to have a package insulation voltage ranging from a few tens to hundreds of volts. In any case, common mode signals could reach easily thousands of volts, thereby generating an electrical over stress to the LEDs.

Connecting the LED thermal pad to a voltage reference protects the LED from EOS generated by common

Figure 11: Luminaire stress caused by a differential mode (red arrow shows the direction of the stress signal on a positive surge, while the blue arrow is on a negative surge)

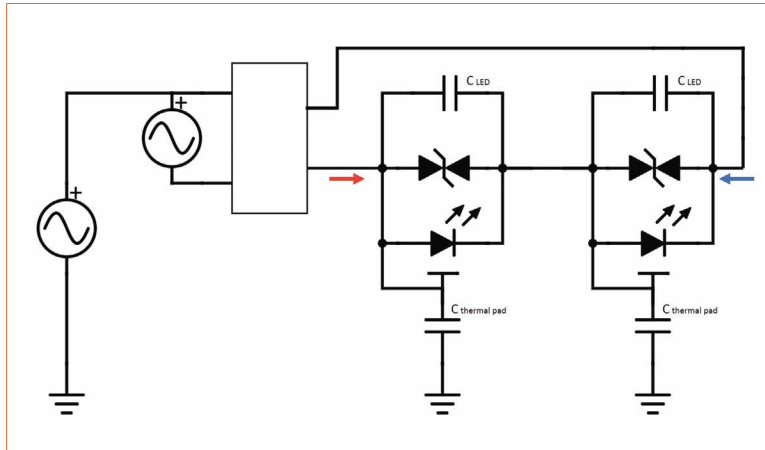
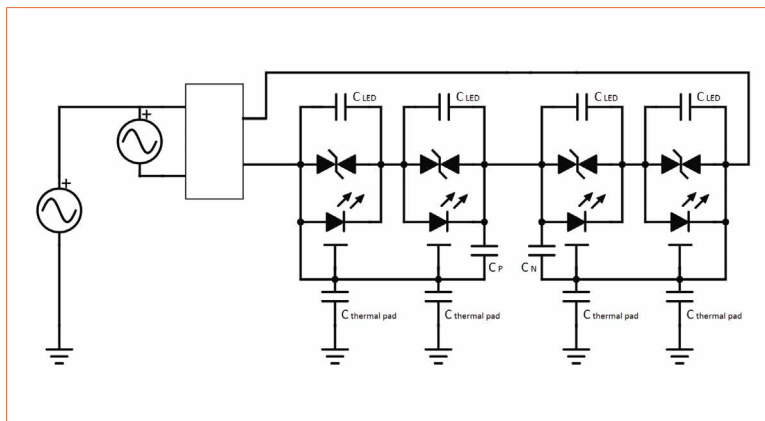

Figure 12: Dividing the LED string in two groups with a mirror configuration as one does not know which type of stress (positive or negative) will occur



mode voltage stress. The signal follows the path towards the earth, via the thermal pad parasitic capacitance, and the voltage across the LED package is limited. Now the need to connect the thermal pad to some electrical potential is clear, but there is still the option to keep them separate or connect them all.

Figure 11 shows the circuit of the luminaire stressed by a differential mode. The red arrow shows the direction of the stress signal on a positive surge, while the blue arrow is on a negative surge. For the purpose of this discussion, the thermal pad's connection to the anode as well as its connection to the cathode will be covered.

In the case of a positive surge and the thermal pad is connected to the anode, the stress will be split between the standard path through the LED string and the parasitic capacitance between the thermal pad and the earth. The split ratio is determined by the impedance ratio of the LED path towards the earth and the first parasitic capacitance of

the thermal pad. It is evident that by connecting the thermal pad, the parasitic capacitance is n times bigger (where n is the number of LEDs), and the impedance is n times smaller – absorbing a big part of the stress.

This means that it is better to connect all thermal pads than leaving them separate. In case of a negative stress signal, the entire signal will pass through the C_{LED} , polarizing the LED in the reverse way. The impedance of C_{LED} is quite high – and therefore the reverse voltage drop will be quite high too. The ESD TVS contributes to clamping the signal, but because the stress is more in the mid-range energy, the LED is EOS damaged by this reverse polarization.

When the signal occurs after the first LED, it finds the thermal pad parasitic capacitance to reach the electrical earth. Other LEDs on the string become stressed, but less and less so, as each $C_{thermal\ pad}$ on the series absorbs part of the stress signal.

When the thermal pads are connected to the cathode, the positive stress totally passes through the first LED, damaging it more than in the previous case with the anode connection. However, in the event of negative stress, the last LED of the series is less stressed.

Thanks to this first analysis, the LED thermal pad should be connected all together and then connected on anode for positive stress, and on cathode for negative stress. It is not possible to know which type of stress (positive or negative) a luminaire is facing; therefore the best configuration is a symmetrical one which divides the LED string in two groups with a mirror configuration (Figure 12). The thermal pad of the LED on the positive side must be connected to the anode, and the one on the negative side, must be connected to the cathode.

To improve the protection of this strong solution even further, two additional capacitors C_P and C_N on positive and negative LED groups are added. The thermal pad areas and C_P and C_N must be designed and selected properly, but this is possible only when working on a physical customer circuit. One must not forget that IEC 60598-1:2014 allows to use proper components to connect the luminaire body to the positive or negative terminals of the power supply output. This will further reduce the potential EOS impacts on the LEDs.

Conclusions

A number of conditions can generate EOS, which is why they are still the main cause of LED failure before the end of an LED expected lifetime. The reasons for EOS are complex, and the operations and variable conditions that can lead to an EOS are multiple.

The above explores all the possible harmful conditions and summarizes the measures to be taken during the luminaire production process and at circuit level, to make each solid-state luminaire safer and long-lasting. ■

NEW CREE® XLAMP® LEDs CAN:

IMPROVE RELIABILITY ::

REDUCE SYSTEM COST ::

REDEFINE LED LIGHTING ::

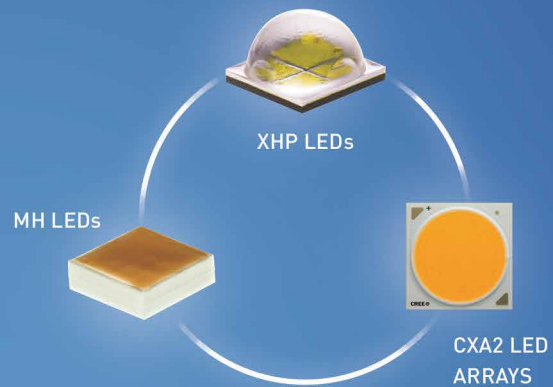

GAME CHANGING IS GREAT. BOTTOM LINE CHANGING IS BETTER.

You can't change your bottom line by using the same LEDs that everyone else is using. Cree's Extreme High Power (XHP) LEDs deliver double the lumen output at high operating temperatures, while our MH LEDs combine the system advantages of our best arrays with the manufacturing ease of a discrete. And our CXA2 LED arrays are packed with lumens to offer system cost savings up to 60%.

CREE 

See how higher power equals lower cost.
cree.com/xhp

The new way to a better LED array.
cree.com/mh

Even more lumens for savings up to 60%.
cree.com/cxa2

Method and Circuit to Maintain Constant Light Output for LED Luminaires

It is difficult to accurately predict the lifetime or the light output degradation of LED luminaires. A Constant Light Output (CLO) operation is implemented in some of the latest drivers. However, there are many factors that require a different algorithm in terms of time rate and forward current values that are usually not taken into account. Prof.Dr.Eng. Stelian Matei, from the Photometry and Electromagnetic Compatibility Laboratory at Electromagnetica SA, proposes and explains a new method is maintaining the luminous flux over the lifetime of the LED luminaire, considering the luminaire global light degradation.

Accurate lifetime prediction or estimation of the light output degradation for LED luminaires is difficult. The reason is the diversity of LED technologies and the particular contribution of the system components such as lens, driver, heatsink, etc., to this process. The life of an LED luminaire is the combined effect of gradual light output degradation caused by material degradation and abrupt light output degradation mostly caused by LED components failure. There are a set of standards defining how LED luminaires can be tested to determine their performance over time such as:

Standards for LED lifetime testing:

- LM-84-14 and TM-28-14
- IEC 62772 luminaire performance

According to IEC 62722-2-1, the LED luminaires using modules in conformity to IEC 62717 definition, may be declared the lumen maintenance value for the module as the maintenance value of the luminaire.

Basically IEC 62722 tolerate replacing LED luminaire lumen maintenance with LED emitting surface as long such data is available. Most of the LED lighting system manufacturers are declaring luminaire lifetime based on this acceptance despite the complexity of this matter. The latest generation of LED drivers is managing this problem by employing a Constant Light Output (CLO) operation. This CLO feature increases the forward current at specific time rate, disregarding overall luminaire performance. Ultimately based on a prediction supposedly applying to any LED technology and luminaire configuration. Unfortunately regardless of the CLO type procedure the method does not compensate real light output degradation of the luminaire even for same type of LEDs, otherwise even the constant light output may not be achieved. In reality there are many factors that require a different algorithm in terms of time rate and forward current values as to maintain a genuine constant light output.

Balanced Light Output (BLO)

To include all combined effects in a CLO operation should require a different procedure otherwise may not be any longer of a preset stepping type. Such a dynamic Balanced Light Output (BLO) method is maintaining the luminous flux over the lifetime of the LED luminaire, considering the real luminaire global light degradation instead of LED projected life. The process starts by establishing a reference, respectively an equivalent value number allocated to the initial luminous flux, may also be called a preset flux, together with an equivalent value number of the light transmission through the diffuser or the optical system (transparency or transmittance) as measured by a sensor. Therefore the reference is a numerical value that is in a mathematical relation to the metrological value of these characteristics. Ultimately these reference values of transmittance and luminous flux are used through a mathematical process to determine the overall level of light degradation of the apparatus. The photometric performance, respectively, the maintenance of the luminous flux over the operating

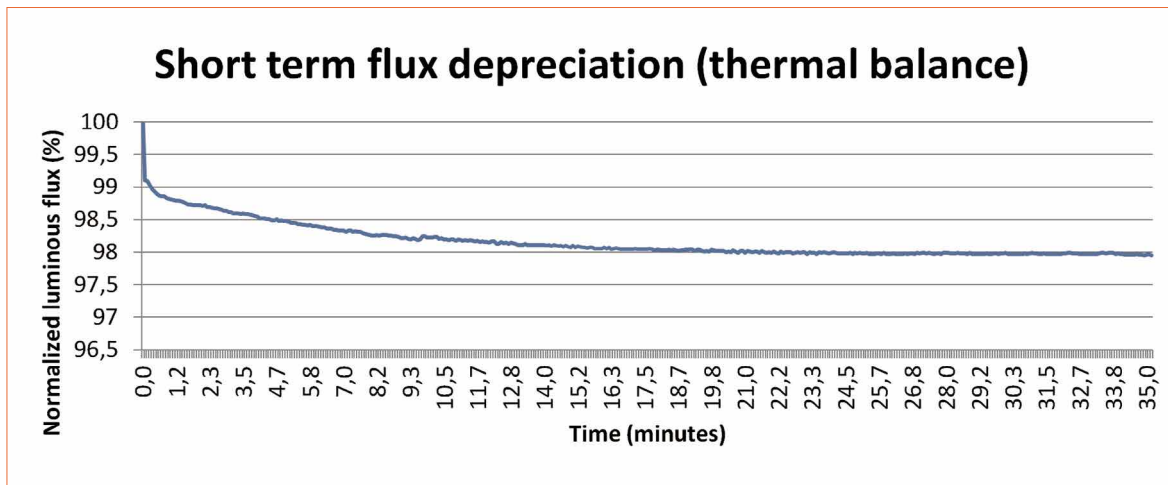

Figure 1:
Flux depreciation due to the thermal balance

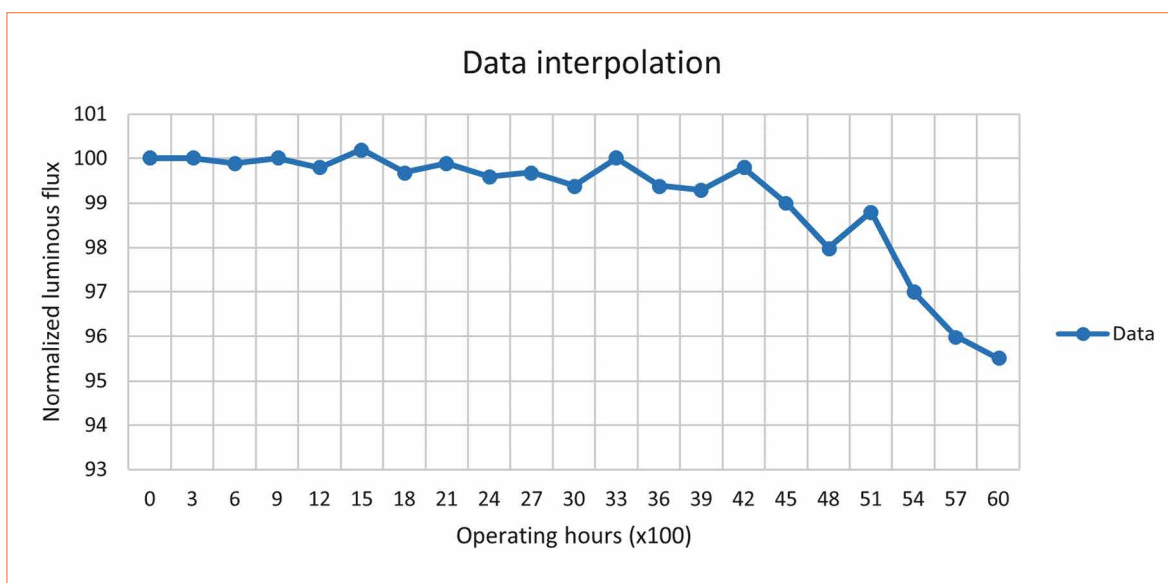

Figure 2:
Normalized lumen output over time

time, is analyzed in relation to the reference values in real time. Finally, the results control the LED's supply current, through the dimming feature of the power supply in order to balance the difference in respect to the overall initial light output performance.

Light degradation process

Decreasing the light output of a luminaire during operation is mainly caused by depreciation of the light source, the diminution of light transmission through the transparent screen (otherwise diffuser), the reduction of the power of the power supply and the ambient temperature conditions. Short term light depreciation is mainly caused by LED's reaching the thermal balance (Figure 1). Since the forward voltage varies with temperature, the output power delivered to LEDs is

decreasing toward balance and may be observed if the input power variation of the LED luminaire is recorded. Practically, a well-designed luminaire, has a very low variation (perhaps 2-3% is acceptable), as a right balance between total LED power and the heatsink size/shape.

Long term light output degradation beyond thermal balance is caused by LED's, the optical material and electronics aging. Measurements of the luminaire's long term light degradation are carried under strict controlled conditions (basically in a laboratory) in respect to procedures as specified in standards. For lamps and luminaires data collection procedure is specified in LM 84-14 and projection for the luminous flux method stated in TM 28-14. Both these normatives consider the luminaire's components

contribution, instead of a single LED test data as a proxy.

Estimating Light degradation

Hence, the CLO method uses the data based LM80 report provided by LED manufacturers, then, long term luminous flux maintenance for LEDs is basically estimated by a mathematical process as explained in TM 21, instead of the real one. According to the TM-21-11, values during a minimum of 6,000 operating hours are processed by approximation exponential regression and then statistically estimating the light degradation six times beyond this period

Approximation by exponential regression is expressed by EQ1:

$$\Phi_t = B \cdot e^{-\alpha t} \quad (EQ1)$$

Figure 3:
Lumen output over time with curve-fit through the average values

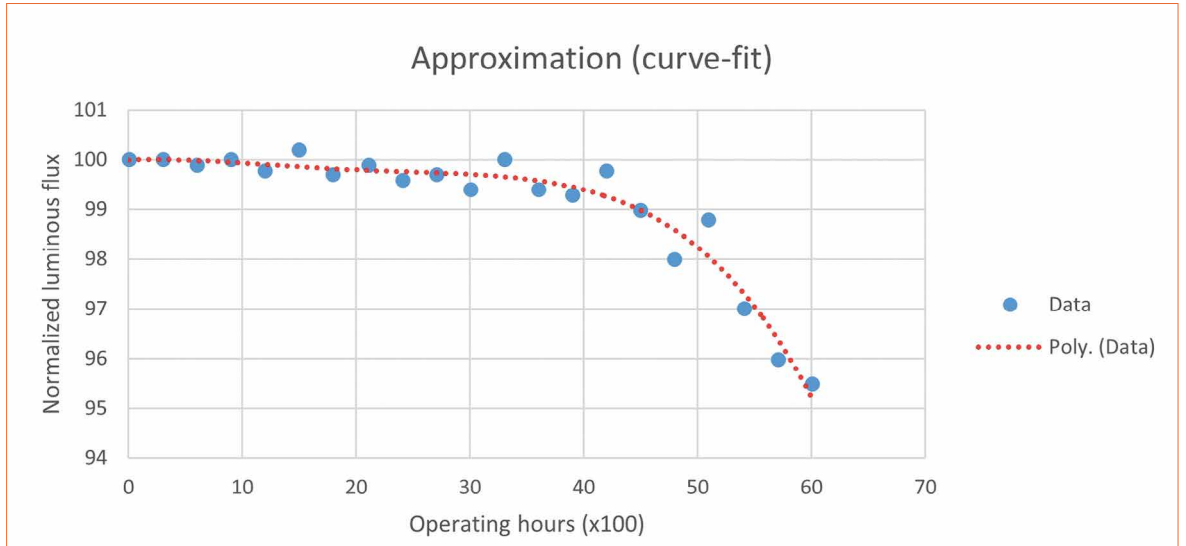

Figure 4:
TM-21 time projection derived from 6000 hours testing

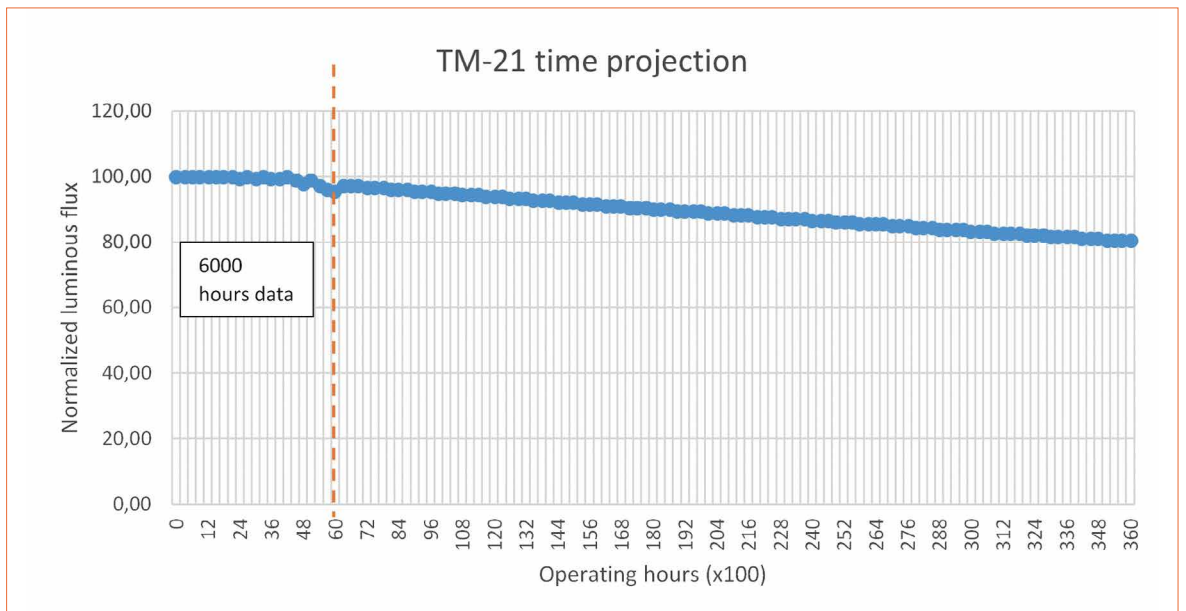

Table 1:
Example of test results

Where:

- t operating time (in hours)
- $\Phi(t)$ averaged normalized luminous flux at time t
- B projected initial constant by the least squares curve-fit of LM-80 data
- α decay rate constant derived by the least squares curve-fit of LM-80 data

When the test period is concluded, the data are normalized for each device to a value of 1 (100%) at 0 hours and then averaged within the same data set (Figure 2).

In order to acquire the decay rate for the test period, an exponential last square curve-fit through the average values is performed (Figure 3), in accordance with EQ1.

To project the luminous flux maintenance beyond test period (6000 hours), TM-21 state the following equation:

$$L_{70} = \frac{\ln \frac{B}{0.7}}{\alpha} \quad (EQ2)$$

Table 1 shows an example of such a result. Otherwise, the results estimate an 80.23% depreciation level for luminous flux after 36,000 hours operating time (Figure 4).

It is unlikely that the real behavior during operating hours of the luminaire, in real conditions is known to be predicted beyond a certain range. Obviously light

| Test Condition – 85°C Case Temp | |
|--|---------------|
| Sample size | 10 |
| Number of failures | 0 |
| DUT drive current used in the test (mA) | 150 |
| Test duration (hours) | 6000 |
| Test duration used for projection (hour to hour) | 1,200 - 6,000 |
| Tested case temperature (°C) | 85 |
| α | 6.49255E-06 |
| B | 1.013505744 |
| Reported L70(6k) (hours) | >33000 |



Das neue **A.A.G. Stucchi Niedervolt-System** wurde entwickelt um alle technischen und designerischen Bedürfnisse zu befriedigen. Sein **intelligenter Kern** mit dem **magnetischen Installations-System** für Leuchten und der **integrierte Datenbus** zur Lichtsteuerung machen es zu einem technischen Vorreiter, während die **verschiedenen erhältlichen Versionen** alle Bedürfnisse des Marktes abdecken.

Dieser Kern bietet die **Freiheit und Flexibilität für Designs** als Basis für die Entwicklung von **maßgeschneiderten Profilen** unter Beibehaltung der Kompatibilität zwischen dem System und den einzelnen Komponenten.

MULTISYSTEM verfügt über **verschiedene Typen von Adaptern**: Standard, Doppelt und für lineare Beleuchtungen, so wie auch verschiedene **Endeinspeisungen und Verbinder** um eine Maximum an Flexibilität für den Projekteinsatz an Wänden, Decken oder Kombinationen aus beiden, zu gewährleisten.

*The new **A.A.G. Stucchi low voltage system** is developed to satisfy all technical and design needs.*

*Its **smart core** with **magnetic installation system** for the lighting fixtures, and **integrated databus** for light control makes it technically at the cutting edge while the **various available versions** of the track are in line with the market's needs.*

*This core provides **freedom and flexibility in design** as it is the base for developing **customized profile tracks**, maintaining compatibility with the system and its components at the same time.*

MULTISYSTEM includes **different types of adapters**: standard, double and built for linear lighting. Different types of **end-feeds and connections** are available, allowing maximum flexibility in projects that run along walls, ceilings, or a combination of both.



A . A . G .

STUCCHI

ideas are made of light

www.aagstucchi.it

Figure 5:
Example of CLO control type

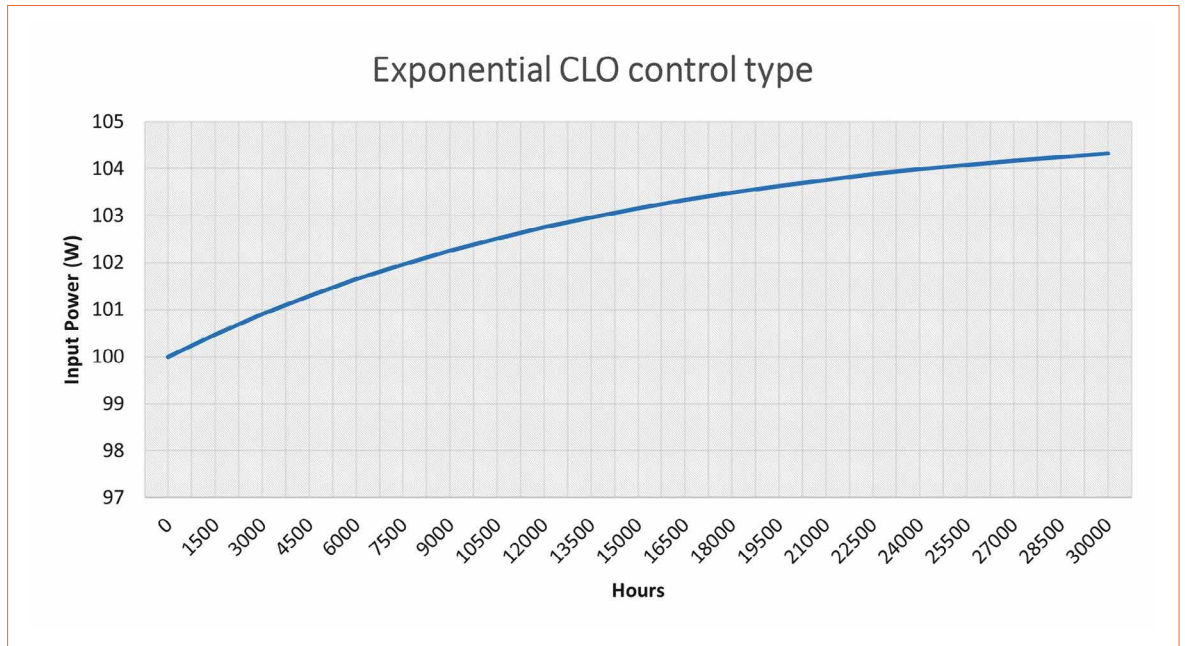
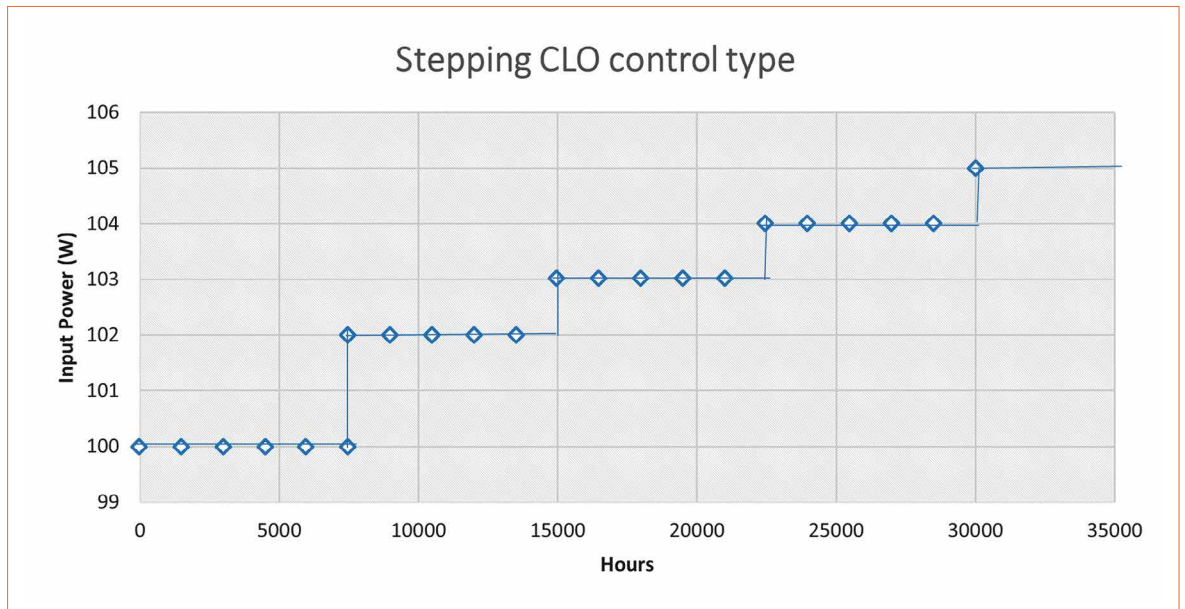

Figure 6:
Example of stepping CLO control type



output depreciation of the luminaires is mainly caused by the thermal stress of the LED emitters, but may also be caused by aging or messing up the transparent screen or the optical system. These two combined depreciation processes are difficult to predict, otherwise the result is reducing the level of illumination and affect function of which was employed (Ex.: the safety and security of users in applications such as street lighting). The implementation of a solution to offset these processes is therefore justified; especially for street lighting.

Constant Light Output (CLO)

As explained previously, lumen maintenance beyond the test period is based on a statistical calculation, otherwise called projection method. There are not too many methods to compensate the light output degradation caused by a combination of elements. The CLO method simply periodically increases the current through LEDs in order to compensate a presumed luminaire's light output degradation. This system compensates a predicted depreciation of luminous flux through a fixed algorithm irrespective to LED technology or environmental conditions to ensure a predefined lighting level during the luminaire's

useful life. One of the algorithms may be expressed by EQ3.

One algorithm for compensating light output degradation:

$$I_t = I_N (1 - e^{-\frac{t}{\tau}}) \tag{EQ3}$$

Where:

- I_t forward current at time t
- I_N nominal forward current
- t operation time
- τ time constant

Without remote management this means simply increasing the initial power upon installation in order to make up for luminous depreciation. By precisely controlling luminous

flux, by means of forward current through LEDs can control the energy necessary to reach the required level (Figure 5).

Another way is to compensate at a fixed rate, for example 1% for every 7500 operation hours (Figure 6). Obviously both methods do not consider LED type/technology, optics degradation power supply as a complete system and environmental conditions.

Regardless of the procedure type, the CLO method does not compensate real light output degradation of the luminaire even for the same type of LEDs. Considering that other system elements behave similarly as power supply, lenses, etc., the luminous flux for the LED type degrades differently, mainly as a result of T_j difference.

Dynamic Balanced Light Output (BLO)

Balanced Light Output method is maintaining the luminous flux, therefore the level of illumination, over the lifetime of the LED luminaire, considering the luminaire's global light degradation instead of LEDs projected. Obviously, an increase in luminous flux is the result of forward current increase through LEDs and consequently, precaution needs to be taken in regards to thermal management. In this regard the heatsink should be designed to accept the maximum LED output power when it reaches maximum balance light output in order to avoid the LED's junction from overheating. For example a 100 W LED luminaire should have a thermal capability of a 120 W luminaire equivalent to a L80 lumen maintenance at the end of life.

Such a BLO system could be employed inside of a LED luminaire, consisting in principle of a body / assembly as the luminaire's heatsink having a transparent screen or light diffuser and a LED light source (Figure 7). The light generated by the LED emitters is monitored by

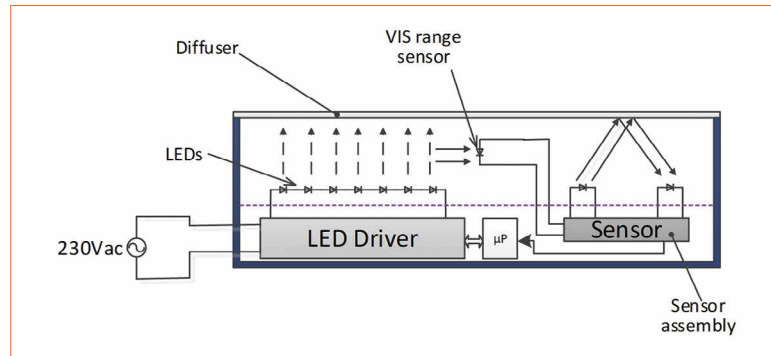

Figure 7:
BLO system assembly

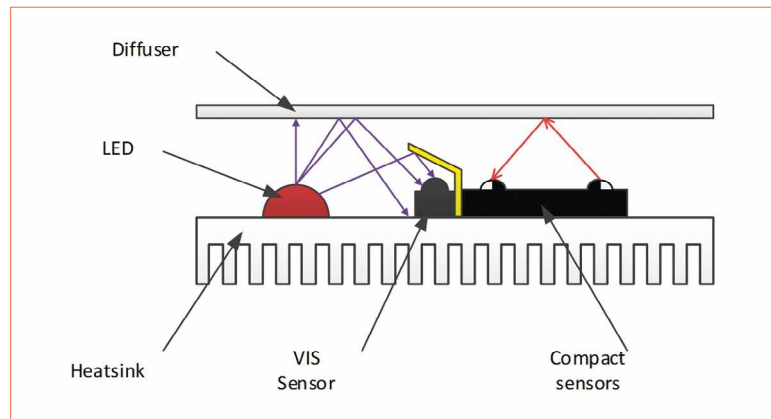

Figure 8:
Sensor assembly side view



Figure 9:
Reflective wall (left)
and the sensor
assembly (right)

a sensor assembly that ultimately controls the power supply driver via a microprocessor. The sensor assembly consists of an IR-infrared emitter-receiver pair, which together detects the transmission through the screen/diffuser. Measurement of the light output generated by the LED emitters inside of the luminaire is performed by a visible VIS sensor.

The sensors assembly is mounted on the surface of the radiator at some distance from the screen / diffuser (Figure 8). Between the transmitter and the receiver is a technological distance and the VIS sensor is indirectly facing the LEDs (Figure 9).

Suitable arrangement for sensor assembly depend on the mechanical characteristics of the luminaire,

respectively the height of the LED emitters, space availability and the type and size of the optics.

The VIS sensor, which is indirectly facing the LED emitters will perform the function of measuring the equivalent value of the total luminous flux. The sensor's position should allow only the detection of light generated by the LED emitters, which is accomplished by using a reflective wall as in figure 9.

Thus, a ratio between the total lumen output of the luminaire and the electrical signal generated by the VIS sensor can be established for system calibration. The value of this signal is equivalent to the luminous flux value or the reference value for assessing the level of light degradation.

Figure 10:
Sensors assembly top view

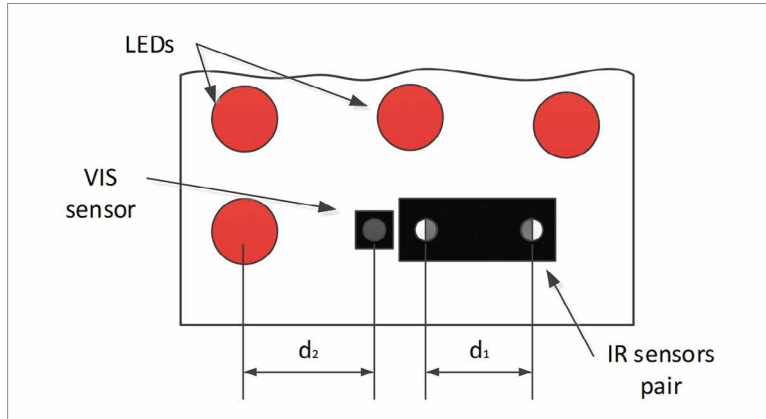

Figure 11:
Actual sensors assembly

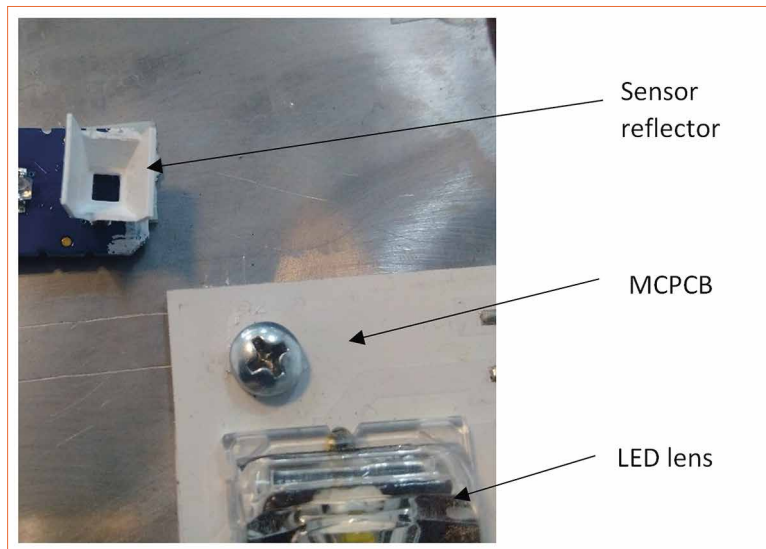

Figure 12:
Transmittance measurement

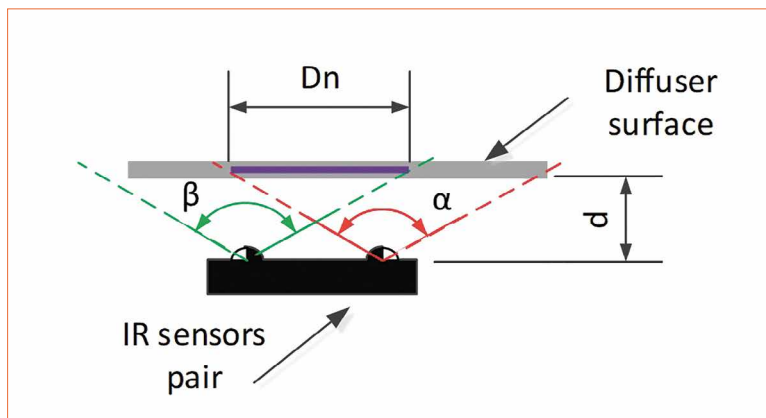
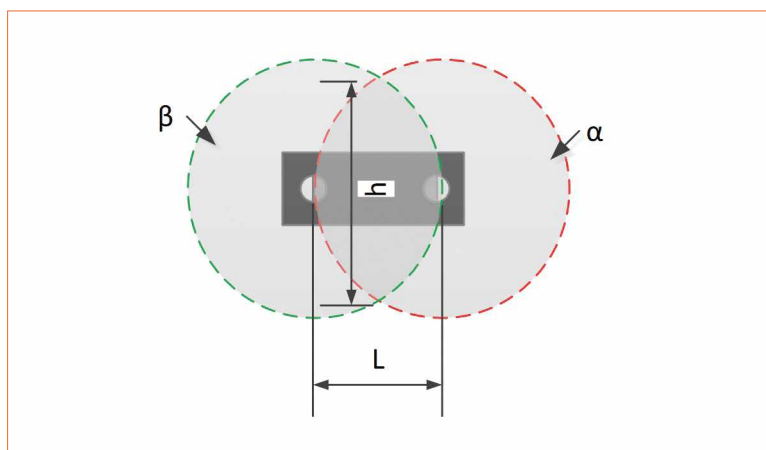

Figure 13:
Projected areas on diffuser for larger L distance between sensors



Transmission of light through the transparent screen (transmittance) is determined by the IR sensors pair. The IR beam generated by the emitter is projected onto the diffuser at the angle α (Figure 12). The intersection with the viewing angle β of the IR sensor on the surface of the screen takes place over the distance D . The intersection surface of the projections of the two cones, respectively, of the sensor, on the surface of the screen is represented by the intersection of two circles corresponding to α and β (Figure 13). When the distance between the transmitter and receiver tends to 0, then $L \sim h$ therefore the projection of the generated beam is practically covered by the viewing angle.

Figure 14 shows the trajectory of the IR beam through the transparent diffuser material. The light transmitted by the IR transmitter is reflected in the A direction by the inner surface of the diffuser, but travels in the C direction towards the exterior, throughout the material to the air.

When the diffuser's material deteriorates, the component in C direction increases (Figure 14) and is redirected inside the diffuser's material, heading the IR receiver. The damage process is caused by the aging of the transparent material, dirt, deformation, or breakage. The degree of damage may be calibrated by a reflection reference material as applied on the surface of the screen. Such a reference material, also known as the "gray card", should allow for developing a relationship between the degree of damage and the signal produced by the sensor. When the diffuser is new, in the very beginning, the level of the signal is recorded and used in the calculation process as a reference value.

The photometric performance, respectively, the maintenance of the luminous flux over the operating time, is analyzed in relation to the recorded reference values.

Clever solutions for a changing world

Fulham's powerful, innovative LED drivers bring tomorrow's technology to today's luminaires.

FULHAM
HOTSPOT LED

HotSpot Plus:

The All-in-One Emergency Driver

The first fully integrated programmable LED driver, emergency LED driver, and replaceable backup battery. Reduces costs, simplifies installation, and brings emergency capability to smaller luminaires.

FULHAM
LUMO SERIES

25W Universal Mains Dimming Driver

A versatile, 220-240VAC dimming driver cleverly designed to work with TRIAC and ELV dimmers and Potentiometers. Ideally suited for COB arrays and LED strips.

FULHAM
Lighting... Global. Clever. Sustainable.

Learn more at our upcoming event

Light+Building 2018 | Stand 4.0 A12
March 18-23, 2018 | Frankfurt, Germany

www.fulham.com

Europe | sales.eu@fulham.com +31 72 572 3000
North America | order@fulham.com +1 323 599 5000



Figure 14:
Projected areas on the diffuser for smaller L distance between sensors

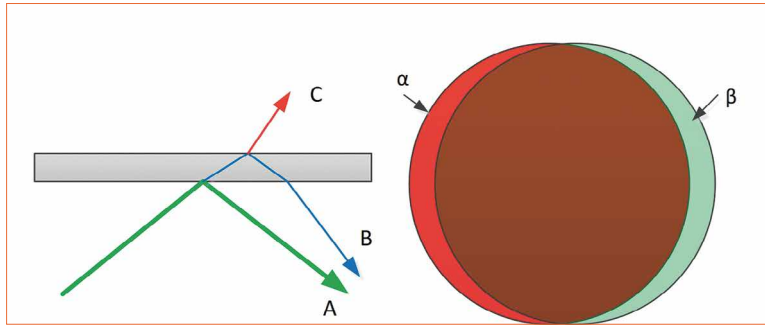
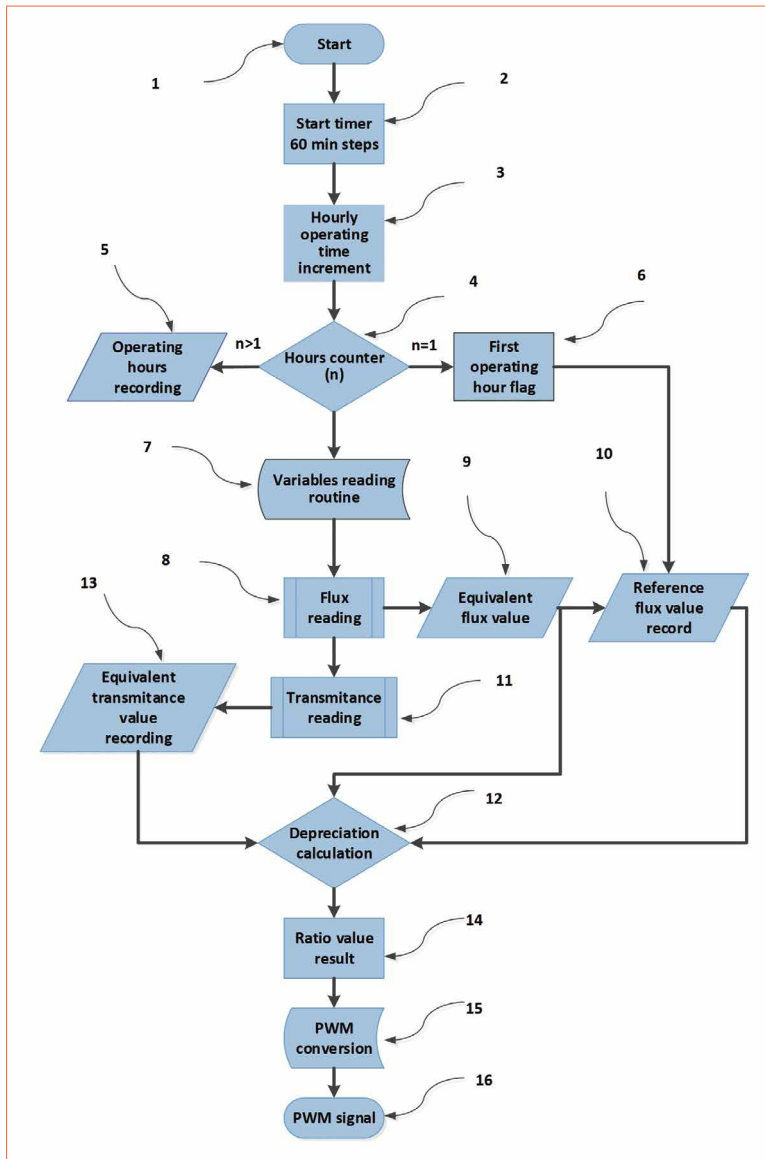

Figure 15:
Flow diagram of the BLO process



Maintaining the luminous flux is achieved by increasing or decreasing the forward current through LED emitters, referring to the reference values of Φ_{Ref} and T_{Ref} . For a LED current driver this action is equivalent to a dimming function, time related to the light degradation.

Figure 15 illustrates the flow diagram of the BLO computing process. When the luminaire is switched ON, a pulse activates a timer in order to generate pulses every 60 min. Each pulse increment increases the hour counter by 1 in order to record the operating hours. When the hour counter has a value of 1 ($n = 1$), otherwise the very first operating hour, the initial flux Φ_{Ref} and transmittance values T_{Ref} are recorded from VIS, respectively, IR sensors. Recording these values (Φ_{Ech} , T_{Ech}) after the first hour, it can be considered that the luminaire reached the thermal equilibrium and thus the stabilization of the parameters (variables) have been achieved. Moreover, the counter (4) triggers every hour reading variables routine (7), in this order: Φ_{Ech} flux reading in (8), followed by reading transmittance TEch in (11). Signal value from the VIS sensor is recorded after each hour in (9). The very first value or the reference Φ_{Ref} is stored in (10), only if the block output (6) indicates as a first operating time. Equivalent flux reading is accomplished in (8), every hour. Once the data is released in (9) triggered the block (11) for transmittance measurement whose value is recorded in (13). The mathematical processing, equivalent to the degradation calculation in relation to the reference values (EQ4 and EQ5) are completed in (12).

The variation of the luminous flux from the initial or reference value is expressed by the equation:

$$\Delta\Phi_v = \Phi_{Ref} - \Phi_{Ech} \quad (EQ4)$$

Where:

- $\Delta\Phi_v$ represents the luminous flux variation
- Φ_{Ech} the measured flux value
- Φ_{Ref} the reference flux value

The variation of the transmittance from the initial value is expressed by the equation:

$$\Delta T_v = T_{Ref} - T_{Ech} \quad (EQ5)$$

Where:

- ΔT_v represents the transmittance variation between
- T_{Ech} the measured value
- T_{Ref} reference value

Therefore the results from the flow diagram are:

$$L_F = \frac{\Delta\Phi_v}{\Phi_{Ref}} \quad (EQ6)$$

$$L_T = \frac{\Delta T_v}{T_{Ref}} \quad (EQ7)$$

If

$$/L_f/ \geq 0.2$$

$$/L_r/ \geq 0.2$$

When $/L_f/$ and $/L_r/$ are greater than 0.2, then an alarm signal is generated as the maximum dimming threshold of 20% is exceeded. Both ratios, relative to the reference values are summed up in (14).

Result of (14):

$$R_{Dg} = LF + LT \quad (EQ8)$$

This represents the equivalent numerical value for the overall light output degradation, otherwise essential in the Balance Light Output process. Furthermore, conversion to a PWM dimming signal, as required to control the power supply / driver, is completed in (15) and recorded in block (16), so that it can be saved as it changes with the operating time.

It is advisable that power control not exceed 20% over of the nominal value so that the luminous flux increasing action does not affect the thermal management of the luminaire unless a thermal reserve was provided.

Conclusion

Unfortunately, regardless of the CLO type procedure, the method does not compensate real light output degradation of the luminaire even for the same type of LEDs. The decrease of the lumen output is predicted with a certain tolerance with information LED luminaire manufacturers gathered from past products launched and marketed.

The Balance Light Output (BLO) option offers guaranteed constant light levels through luminaire lifetime. Hence, the driver's dimming feature, combined with the BLO platform, enables the environment to have a constant light output. The driver controls the power provided to the LEDs ensuring an equal lighting intensity throughout the lumen depreciation period.

Therefore, BLO features take account of:

- Global depreciation curve of the luminaire, based on the real time measurement.
- Provides luminaire real lumen maintenance not predicted by photometry during lifetime of the product.
- Avoids site over lighting situation that would be happening with standard LED lights for half of product's useful life.
- Autonomous, no input needed from the customer.
- Customized program.

The BLO option now provides the possibility of adapting an LED power supply to the lumen depreciation curve for the product's entire life cycle. ■

LEADING THE WAY TO A CONNECTED FUTURE



The future. Illuminated.

2018

CHICAGO, IL USA

McCormick Place

PRE-CONFERENCE

May 6 – 7, 2018

**TRADE SHOW &
CONFERENCE**

May 8 – 10, 2018

LIGHTFAIR.COM

IALD



AmericasMart
Atlanta

PHOTO CREDITS

© SCOTT FRANCES/OTTO & COURTESY
BARNEYS NEW YORK



LED professional Review (LpR) - Annual Subscriptions

LpR Digital Magazine

- 6 issues
- pdf download
- high resolution pictures and graphs
- printable
- commercial use
- access to all previous issues
- Euro 78.80

LpR Printed Magazine

- 6 issues
- Euro 158.40

<http://www.led-professional.com/subscription>

Cover-page

Artwork: Thomas Klobassa,
©LED professional 2017

Main Image: Arno Grabher-Meyer,
LED professional

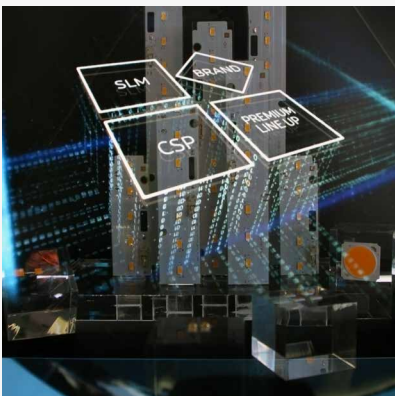

Presentation of Samsung's LED CoB and module portfolio at their booth at Light + Building 2016

Next LpR

SMART MANUFACTURING & TESTING
Issue 67 - May/June 2018

TECH-TALKS BREGENZ

Ken Munro - Partner and Founder of Pen Test Partners

Ken Munro works for Pen Test Partners, a company that specializes in the security of the Internet of Things. He is a so-called ethical hacker. At LpS 2017 he demonstrated shocking security leaks. In the interview he talked about what else can go wrong and how engineers can avoid mistakes in product design and applications. To sum things up he also explained why the end user should be better informed about how to correctly operate a system in order to be as safe as possible. ■

RESEARCH

"Best Papers" at LpS 2017: Automatic Panel Level Transient Thermal Tester

The thermal resistance junction in case is an important parameter for the reliability of LEDs because degradation of the LED is temperature driven. Transient thermal analysis (TTA) is still work and time consuming and not automated. The authors present and discuss an automatic panel level TTA tester. They explain the challenges and the solution and demonstrate the applicability of using LED test board-panels. ■

MANUFACTURING

Manufacturing Revolution Entering the LED Lighting Industry

Western business investments in local manufacturing facilities have been declining since the 1980s due to partnering with contract manufacturers in Asia. But with increasing and hidden costs in Asia companies are now seeking to bring manufacturing back home. A recent innovation, micro-factories could be the solution. The authors present the micro-factory as a new, flexible manufacturing concept, and analyze the benefits of local, automated production of LED lighting products, as an alternative to contract manufacturing in Asia. ■

TECHNOLOGIES

Integrating Lighting in the Internet of Things

Following the rapid penetration of LEDs lighting now becomes integrated into the Internet of Things. Over the past three years a consortium of leading European companies worked on the OpenAIS project, partly funded by the EU within the Horizon 2020 program, now showing the results working at a full size demonstrator. The authors show how OpenAIS creates an open ecosystem to enable a wider community to deliver the smartness of light and they explain how it is possible to adapt the system to cater to the diversity of people and demands. ■

subject to change

Imprint

LED professional Review (LpR), ISSN 1993-890X

Publishing Company

Luger Research e.U.

Institute for Innovation & Technology
Moosmähdstrasse 30
A 6850 Dornbirn, Austria / Europe
phone +43 5572 39 44 89
fax +43 5572 20 60 70
info(at)lugerresearch.com
www.lugerresearch.com

Publisher

Siegfried Luger +43 699 11 33 55 70
s.luger(at)led-professional.com

Editor-in-Chief

Arno Grabher-Meyer +43 699 11 33 55 18
a.g-m(at)led-professional.com

Int. Account Manager

Theresa Koenig +43 699 11 33 55 20
theresa.koenig(at)led-professional.com

MarCom Manager

Bronwen Rolls +44 797 401 2962
bronwen.rolls(at)led-professional.com

Your Sales Contacts

Int. Sales Manager

Brigitte Lindner +43 699 11 33 55 19
brigitte.lindner(at)led-professional.com

China, Hong-Kong

Iris Yuen +86 1380 27 01 367
irisyuen88(at)gmail.com

Germany

Armin Wezel +49 30 526 891 92
armin(at)eurokom-media.de

India

Priyanka Rai +91 124 478 7331
priyanka.ra(at)binarysemantics.com

Japan

Eiji Yoshikawa +81 3 6751 0090
scala(at)s3.dion.ne.jp

South Korea

Jung Won Suh +82 2 78 58 222
sinsegi-2(at)sinsegimedia.info

Taiwan

Leon Chen +886 2 256 81 786-10
leon(at)jkmedia.com.tw

UK, Ireland, Benelux, Scandinavia

Zena Coupé +44 1923 85 25 37
zena(at)expomedia.biz

US East

Karen C Smith-Kernc +1 717 397 7100
KarenKCS(at)aol.com

US West & Canada

Alan A. Kernc +1 717 397 7100
AlanKCS(at)aol.com

Copyrights - Luger Research e.U.

The editors make every reasonable effort to verify the information published, but Luger Research e.U. assumes no responsibility for the validity of any manufacturers, non profit organizations or individuals claims or statements.

Luger Research e.U. does not assume and hereby disclaims any liability to any person for any loss or damage caused by errors or omissions in the material contained herein, regardless of whether such errors result from negligence, accident or any other cause whatsoever. You may not copy, reproduce, republish, download, post, broadcast, transmit, make available to the public, or otherwise use LED professional Review (LpR) content without prior written consent from Luger Research e.U. - Institute for Innovation & Technology, Austria. ■



! GET YOUR FREE E-MAGAZINE
www.led-professional.com/free



The Global Information Hub for Lighting Technologies

LED professional is the comprehensive publication and platform, connecting experts in the design, testing and production of the latest lighting technologies information from around the world.

LED
professional

MORE THAN
31,500
READERS

www.led-professional.com

powered by Luger Research e.U.

HortiCoolture. LED it grow!



#LEDITGROW

*WE speed up
the future*

Horticulture LED Lighting

New horticultural products from the high power ceramic series. Specially chosen wavelengths (450 nm, 660 nm and 730 nm) increase photosynthesis, optimizing plant development and growth. With outstanding PPF-value, small size and low power consumption, the WL-SMDC is the future choice for horticultural lighting. Available ex stock. Samples free of charge.

For further information please visit:

www.we-online.com/leditgrow

For a short introduction of Horticulture

LEDs read our Application Note:

www.we-online.com/AN-Horti

- High efficacy
- Individually adjustable color spectrum for each plant
- Full color spectrum available incl. white, UV and IR-LEDs
- Low thermal resistance
- Electrically neutral thermal path
- One footprint for all colors

