

*The technology of tomorrow for general lighting applications.*

March 2007 | Issue **01**



## White LEDs

|                      |      |
|----------------------|------|
| News                 | p 02 |
| Downlights           | p 07 |
| Technology           | p 10 |
| Life Time            | p 13 |
| Technological Trends | p 16 |

## Product News

### Seoul Semiconductor upgrades design and improves brightness of Acriche by 20% to 48 lm/W



Seoul Semiconductor, the country's leading LED producer and one of the ten largest in the world, released Acriche 2W single emitter of octagon type, a brighter and new design of the innovative semiconductor lighting source that runs directly from AC power without converters. Acriche 2W single emitter of octagon type has a luminous efficacy of 48 lm/W, which is 20% brighter than the version the company began mass producing last November. This level of brightness is comparable to conventional LEDs which report 57 lm/W but experience a 20% loss in conversion. Seoul Semiconductor plans to increase Acriche's luminous efficacy to 80 lm/W in the fourth quarter of 2007, and to 120 lm/W in 2008.

"Our team of engineers has been working around the clock, and we are very proud that in just three months we have been able to deliver this kind of improvement," said Do Hyung Kim, head of the Acriche unit at Seoul Semiconductor.

Acriche's new packaging as a single emitter with a diameter of 25 mm also enhances its use for various applications. "You can apply second optics (collimators) to Acriche 2W octagon type to adjust for various lighting applications," said Mr. Kim. "For instance, the lens with narrow viewing angles can be used for lighting fixtures that focus on a certain area such as reading lamps, while the lens with wide viewing angles can be used to illuminate a wider space like a living room in a home or an office."

The company is planning to release Acriche single emitter without a PCB soon. "This will broaden the range of application for Acriche even more as our customers will be able to make the PCB type they need and array emitters on the PCB," said Mr. Kim.

Acriche is a more efficient and brighter lighting source. With its new architecture, Acriche reduces electricity costs by 85% compared to incandescent lamps; and by 50% compared to general fluorescent lamps. Its luminous efficacy of 48 lm/W is also higher than halogen at 20 lm/W and incandescent at 15 lm/W. Acriche's ability to focus lighting also makes it more efficient than incandescent and fluorescent which emits 360 degrees of light.

Acriche has been designed for conventional lighting applications including architectural lighting, scenery lighting (such as park lighting), stand lighting, exit lighting, street lamps, industrial lighting and many others.

### First Components presents the industry's brightest single-chip LED with 250 lumens

Munich, First Components offers the KLC8 series from Edison Opto, a Taiwan based high-power LEDs packaging manufacturer. The new series presents the industry's brightest single-chip LED with 250 lumens at a drive current of 1A. It also delivers unprecedented high luminous efficacy of 100 lumens/watt at 350mA, with a lifespan exceeds 50,000 hours. KLC8 is incorporated the most advanced packaging technologies from Edison Opto and results in preferable quality and attributes. Its unique characteristic of being able to operate within a wide range of drive current (0~1000 mA) makes it a definite choice for energy saving illumination. This new LED delivers higher efficacy values than conventional fluorescent and incandescent lamps, and is suitable for use in general illumination, decorative lighting, street lighting, LCD display, projector, and more. There are white and warm white KLC8s available. These sophisticated LEDs are sealed in tape and reel packaging, and conform to the requirements of Pb-free IR-Reflow process. It will help to simplify the manufacturing process and yield elevated productivity.



## New EZBright™ 700 LED power chip broadens Cree's high-performance chip platform

DURHAM, NC, Cree, Inc. (Nasdaq: CREE), a leader in LED solid-state lighting components, announced the release of its newest EZBright LED power chip. The EZBright 700 LED is the latest blue chip product based on Cree's flagship proprietary EZBright LED platform, which continues to set performance standards across a broad range of the LED marketplace. The EZBright 700 is the brightest, most cost-effective LED chip of its size.

The EZBright 700 achieves a typical output of 260 mW at 350 mA and 440 mW at 700 mA. It is targeted for general lighting applications, including auto headlamps, streetlights, camera flash, projection lighting, personal lighting and indoor and outdoor display applications. The EZBright platform features a proprietary optical design that delivers an optimal Lambertian radiation pattern with reduced emission losses and high efficiency compared to Cree's other LED chip platforms. This high-efficiency design scales well with the size of the chip, a significant achievement for the industry.

"Cree recognizes the market need for high performance at low cost across a range of lighting applications," stated David Davito, Cree director of marketing for optoelectronics. "With the mid-size format EZBright 700, we're expanding the EZBright line to address a broader range of lighting markets."

EZBright 700 LEDs are now shipping in production quantities. For additional information on Cree EZBright blue and green LEDs, please call (800) 533-2583 or visit [www.cree.com](http://www.cree.com).

## New super bright LED light source from OSRAM Opto Semiconductors

With its new version of OSTAR Lighting, OSRAM Opto Semiconductors presents its first coldwhite LED to achieve more than 1000 lumen. This means it is brighter than a 50 W halogen lamp, making it ideal for a wide range of applications in the general lighting sector. Samples of the new OSTAR Lighting LED will be produced in the next three months. Market launch is planned for summer 2007.

The new LED light source is based on well established components, which means that progress from the development stage to the production stage will be rapid. The enormous increase in brightness is the result of major improvements to the overall system of chip and package.

The high-flux LED is equipped with six closely packed 1 mm<sup>2</sup> high-power chips. This high chip packing density leads to a high luminance. What this means in actual practice is that a single OSTAR Lighting with a 38° reflector is all that is needed to illuminate a desk with more than 500 lux from a height of two meters. OSTAR is also setting new standards in efficiency, producing 75 lm/W from an operating current of 350 mA.

The new OSTAR Lighting LED was developed as part of the BMBF NanoLux program.



## Philips Lumileds shatters 350 mA performance records with 115 lm/Watt LED

San Jose, California – Philips Lumileds, the pioneer and the leader in high-power LED technology, announced new performance records for high-power white LEDs.

Philips Lumileds 1x1 mm<sup>2</sup>, chip based white LEDs, operating at just 350 mA, delivered 136 lumens for a light source efficiency of 115 lumens per Watt at a correlated-color temperature (CCT) of 4685K. At 2000 mA, Philips Lumileds white LEDs delivered 502 lumens at a corresponding 61 lumens per Watt. These LEDs are the first high-power LEDs to break through the 100 lumen per Watt mark and demonstrate the real potential of solidstate lighting technology.

### Philips Lumileds High-Power, White LED

| Current         | 350mA | 2000mA |
|-----------------|-------|--------|
| Lumens          | 136   | 502    |
| Lumens per Watt | 115   | 61     |
| Watts           | 1.2   | 8.3    |

Philips Lumileds, the creator of the 350 mA high-power LED, continues its innovation by developing more powerful LEDs capable of long life when driven at 1000 mA – 2000 mA and higher. This innovation improves the light efficacy and the light quality, all while offering the lower cost required by many applications. Notable in the performance numbers is the CCT which is significantly lower than those typically reported. These results clearly demonstrate Philips Lumileds' progress in both light output and light quality. Philips Lumileds achieved the record results for white LEDs by combining several new and innovative technologies it has developed. The first devices using these technologies will be introduced in a new generation of products during this quarter. These new technologies will continue to proliferate in new, and existing, products throughout the next 12-18 months. Philips Lumileds breakthroughs in epitaxy, device physics, phosphor, and packaging technologies are critical to delivering the performance required of LEDs as they continue their growth into a preferred light source.

The light output performance announced and available to the industry in the near future, is 17 times greater at the same power than was available in 1999 when Philips Lumileds introduced the first high-power LED. While performance numbers continue to increase for low power LEDs, operating at lower currents such as 20mA, high-power LEDs are required to deliver the quality and quantity of light required for and tomorrow's lighting applications.

## Research News

### Panasonic develops White Color Power LEDs by employing GaN Substrates

From middle of March 2007, Panasonic will mass-produce a white high-power LED series using GaN elements. Use of a GaN substrates, which has very high thermal and electrical conductivity, substantially improves the performance of this LED in the high current area, and achieves the industry's top-level output. The emitted light wavelength is 460 nm, the total radiation flux 355 mW at a forward current of 350 mA, with an external quantum efficiency of 38%.

Its marked crystal stability gives it high reliability as a device, and since the substrates and light-emitting layer have the same refractive index, the result is light delivery efficiency over 1.5 times that of the conventional company sapphire-based LED element.

The blue LED element covered with a uniform fluorescent layer results in a compact white high-power LED with little color variation. Application of this technology is likely to bring forward the development of new applications, such as LED-based lighting and camera flashes.

An LED produced on a sapphire substrates based on current primary technology suffers problems with light emission efficiency due to the difference in refractive index between the substrates and the light-emitting layer. Poor heat dissipation properties tend to result in saturation of output at high currents. The conventional fluorescence application process generates unevenness in the white color, and the large volume of the white light-emitting body limits the optical design possibilities of the lens.

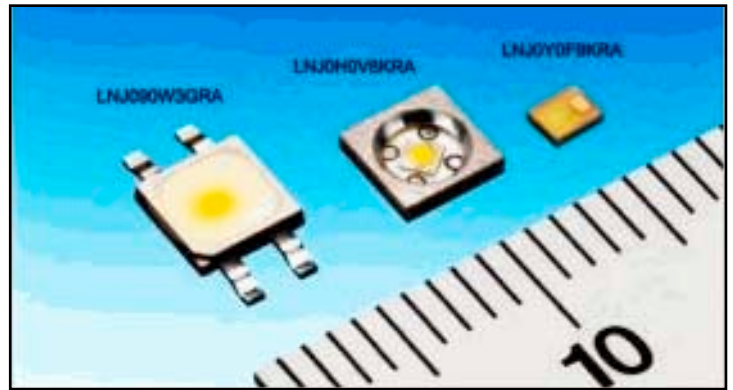

### Rensselaer researchers create world's first ideal anti-reflection coating

Troy, N.Y. -- A team of researchers from Rensselaer Polytechnic Institute has created the world's first material that reflects virtually no light. Reporting in the March issue of Nature Photonics, they describe an optical coating made from the material that enables vastly improved control over the basic properties of light. The research could open the door to much brighter LEDs, more efficient solar cells, and a new class of „smart“ light sources that adjust to specific environments, among many other potential applications.

Most surfaces reflect some light – from a puddle of water all the way to a mirror. The new material has almost the same refractive index as air, making it an ideal building block for anti-reflection coatings. It sets a world record by decreasing the reflectivity compared to conventional anti-reflection coatings by an order of magnitude.

A fundamental property called the refractive index governs the amount of light a material reflects, as well as other optical properties such as diffraction, refraction, and the speed of light inside the material. „The refractive index is the most fundamental quantity in optics and photonics. It goes all the way back to Isaac Newton, who called it the 'optical density,'" said E. Fred Schubert, the Wellfleet Senior Constellation Professor of the Future Chips Constellation at Rensselaer and senior author of the paper.

Schubert and his coworkers have created a material with a refractive index of 1.05, which is extremely close to the refractive index of air and the lowest ever reported. Window glass, for comparison, has a refractive index of about 1.45.

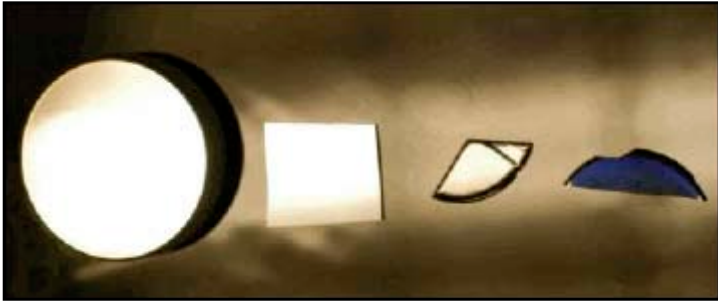

From left, light reflecting off surfaces made from aluminum, silicon, and aluminum nitride. At right side is a piece of aluminum nitride coated with the new anti-reflection material.

## Incredible New Things in Optics and Photonics

Scientists have attempted for years to create materials that can eliminate unwanted reflections, which can degrade the performance of various optical components and devices. „We started thinking, there is no viable material available in the refractive index range 1.0-1.4,“ Schubert said. „If we had such a material, we could do incredible new things in optics and photonics.“

So the team created one. Using a technique called oblique angle deposition, the researchers deposited silica nanorods at an angle of precisely 45 degrees on top of a thin film of aluminum nitride, which is a semiconducting material used in advanced light-emitting diodes (LEDs). From the side, the films look much like the cross section of a piece of lawn turf with the blades slightly flattened.

The technique allows the researchers to strongly reduce or even eliminate reflection at all wavelengths and incoming angles of light, Schubert said. Conventional anti-reflection coatings, although widely used, work only at a single wavelength and when the light source is positioned directly perpendicular to the material.

## A Broad Spectrum of Applications

The new optical coating could find use in just about any application where light travels into or out of a material, such as:

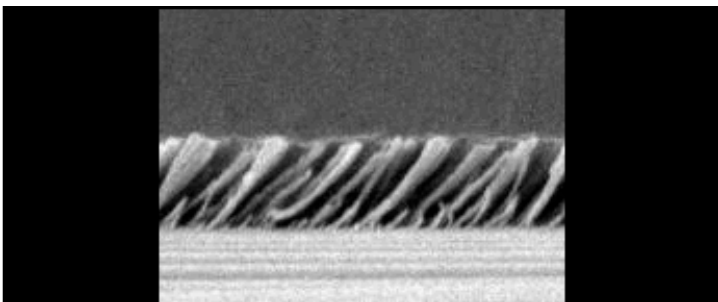

To achieve a very low refractive index, silica nanorods are deposited at an angle of precisely 45 degrees on top of a thin film of aluminum nitride.

-- More efficient solar cells. The new coating could increase the amount of light reaching the active region of a solar cell by several percent, which could have a major impact on its performance. „Conventional coatings are not appropriate for a broad spectral source like the sun,“ Schubert said. „The sun emits light in the ultraviolet, infrared, and visible spectral range. To use all the energy provided by the sun, we don't want any energy reflected by the solar cell surface.“

-- Brighter LEDs. LEDs are increasingly being used in traffic signals, automotive lighting, and exit signs, because they draw far less electricity and last much longer than conventional fluorescent and incandescent bulbs. But current LEDs are not yet bright enough to replace the standard light bulb. Eliminating reflection could improve the luminance of LEDs, which could accelerate the replacement of conventional light sources by solid-state sources.

-- „Smart“ lighting. Not only could improved LEDs provide significant energy savings, they also offer the potential for totally new functionalities. Schubert's new technique allows for vastly improved control of the basic properties of light, which could allow „smart“ light sources to adjust to specific environments. Smart light sources offer the potential to alter human circadian rhythms to match changing work schedules, or to allow an automobile to imperceptibly communicate with the car behind it, according to Schubert.

-- Optical interconnects. For many computing applications, it would be ideal to communicate using photons, as opposed to the electrons that are found in electrical circuits. This is the basis of the burgeoning field of photonics. The new materials could help achieve greater control over light, helping to sustain the burgeoning photonics revolution, Schubert said.

-- High-reflectance mirrors. The idea of anti-reflection coatings also could be turned on its head, according to Schubert. The ability to precisely control a material's refractive index could be used to make extremely high-reflectance mirrors, which are used in many optical components including telescopes, optoelectronic devices, and sensors.

-- Black body radiation. The development could also advance fundamental science. A material that reflects no light is known as an ideal „black body.“ No such material has been available to scientists, until now. Researchers could use an ideal black body to shed light on quantum mechanics, the much-touted theory from physics that explains the inherent „weirdness“ of the atomic realm.

Schubert and his coworkers have only made several samples of the new material to prove it can be done, but the oblique angle evaporation technique is already widely used in industry, and the design can be applied to any type of substrate – not just an expensive semiconductor such as aluminum nitride.

Schubert is featured in an interview about the research in the same issue of Nature Photonics.

Several other Rensselaer researchers also were involved with the project: Professors Shawn-Yu Lin and Jong Kyu Kim; and graduate students J.-Q. Xi, Martin F. Schubert, and Minfeng Chen.

The research is funded primarily by the National Science Foundation, with additional support from the U.S. Department of Energy, the U.S. Army Research Office, the New York State Office of Science, Technology and Academic Research (NYSTAR), Sandia National Laboratories, and the Samsung Advanced Institute of Technology in Korea. The substrates were provided by Crystal IS, a manufacturer of single-crystal aluminum nitride substrates for the production of high-power, high-temperature, and optoelectronic devices such as blue and ultraviolet lasers.

Under Schubert's leadership, the Future Chips Constellation focuses on innovations in materials and devices, in solid state and smart lighting, and applications such as sensing, communications, and biotechnology. A new concept in academia, Rensselaer constellations are led by outstanding faculty in fields of strategic importance. Each constellation is focused on a specific research area and comprises a multidisciplinary mix of senior and junior faculty and postdoctoral and graduate students.

## Philips Lumileds LED technology fundamentally solves efficiency losses at high drive currents

San Jose, CA – Philips Lumileds announced it has fundamentally solved the problem of "droop", a phenomenon common to white power LEDs in which efficacy (lumens per watt) decreases as current increases. The breakthrough, by the company's engineers and scientists, enables efficacy to continue to increase even as drive current increases. The new technology will be implemented in 2007 in the company's LUXEON® LEDs which already deliver leading light output at drive currents of 1000mA and higher. Sampling of products is expected to begin in the next 90 days with full production in Q3 of 2007.

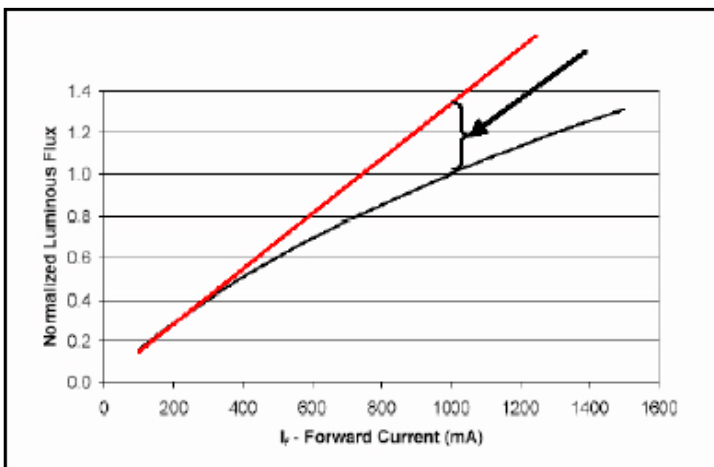

Philips Lumiled efficiency gain

More light and higher efficacy for white LEDs are essential to opening new lighting markets and to expand the reach of LED lighting into residential lighting segments. Incorporating this new epitaxial technology will allow Philips Lumileds to deliver the industry's first high-power LEDs that deliver 70 or more lumens per watt at drive currents of 1000mA and higher.

"Philips Lumileds ability to deliver high-efficacy at high-currents will further enable the lighting market where maximum light output and efficacy are critical" said Frank Steranka, Executive VP Research & Development. While 350mA devices continue to improve in light output, they cannot deliver the light output of devices operated at 1A, 2A or even higher. Most LED manufacturers have acknowledged the need to move beyond the 350mA space and have recently announced devices that can operate at currents up to 1000mA. LUXEON® K2 already

supports a maximum current of 1.5A and with our focus on power LEDs we will continue to expand that operating range."

As part of the company's expansion efforts, including its new wafer-fab in Singapore, Philips Lumileds is adding the necessary equipment and technology to its production lines so that the new technology can be implemented quickly.

### LED professional Review

#### Editors:

Siegfried Luger, EMBE

Arno-Grabher Meyer

Jasmine Leger, Dr.

E-mail: [editors@led-professional.com](mailto:editors@led-professional.com)

+43 5572 394489

#### Advertising sales:

Siegfried Luger

E-mail: [editors@led-professional.com](mailto:editors@led-professional.com)

+43 5572 394489

LED professional Review is published by  
Luger Research – Institute for Innovation & Technology

#### Contact address:

Luger Research (department LED professional),

Rhombergs Fabrik, A 6850 Dornbirn, Austria

Copyright © 2007 Luger Research

All rights reserved.

## LEDs for use in downlights

> Dr. Jasmine Leger, LED professional

### About recessed downlights:

#### Popular:

Recessed downlights, also known as recessed "cans", are the most popular installed lighting fixtures for new and remodeled homes, and commercial buildings.

Downlights are used for general ambient lighting in kitchens, hallways, bathrooms, and other areas of the home. Downlights with small apertures and more directional lensing and baffling are also used for wallwashing and accent lighting. In commercial settings, a wide variety of downlight types, sizes, and finishes are used in lobbies, perimeter areas, hallways, and restrooms.

Although precise numbers of the installed stock of residential recessed downlights are not available, PNNL estimates there are at least 350 million currently installed in US homes and around 20 million sold each year. The vast majority of all installed recessed downlights in the United States use incandescent light sources. In the California study, only 0.4 percent of recessed downlights used compact fluorescent lamps (CFLs).

#### Energy intensive:

Most installed recessed cans are not airtight, so they can also allow heated air to escape from the living area into unconditioned spaces like attics and crawlspaces. Non-airtight fixtures can actually have a „chimney effect," sucking heated air out of the house, leaving the occupants cold, driving up heating costs, and wasting fuel and money. In hotter climates, leaking recessed fixtures can increase the air conditioning load by allowing more heat to enter the house.

#### Making recessed downlights more energy efficient:

Lighting energy efficiency can be greatly improved by using compact fluorescent lamps (CFLs) in place of incandescent bulbs. In non-airtight cans, screw-in CFLs can replace incandescent lamps for immediate energy savings. However, much of the light from a standard CFL will be lost inside the recessed fixture. Reflector lamps address this problem, but there are currently very few CFL reflector lamps available in consumer markets. Further, when higher-wattage screw-in CFLs are used in an airtight recessed can, an additional challenge arises: heat generated by the lamp and ballast can become trapped inside the fixture, and excessive heat can cause CFLs to have lower light output and a shorter lifespan. Would LEDs do better?

### Potential for use of LEDs in downlight:

The light output of a recessed downlight is a function of the lumens produced by the lamp and the luminaire efficiency. Reflector-style lamps are specially shaped and coated to emit light in a defined cone, while "A" style incandescent lamps and CFLs emit light in all directions, leading to significant light loss within the luminaire. Downlights using nonreflector lamps are typically only 50% efficient, meaning about half the light produced by the lamp is wasted inside the fixture. LEDs are more directional, but can they provide enough light? For comparison, the table below shows typical light output and efficiency of residential-style fluorescent and incandescent recessed downlights and an LED downlight.

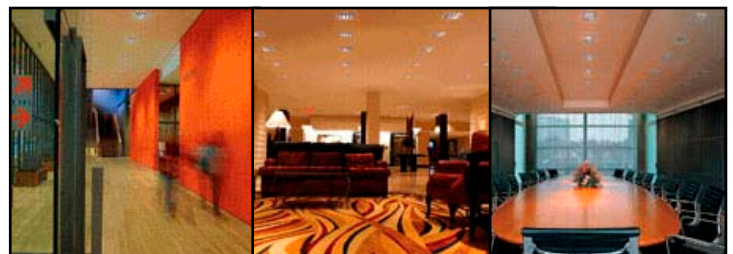
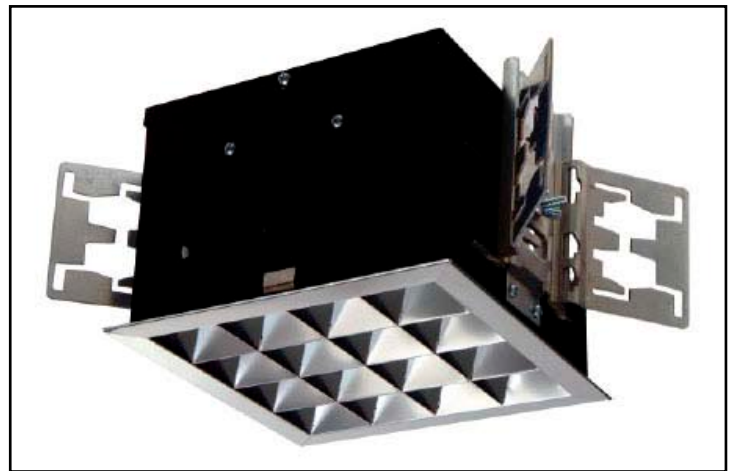

Gallium Lighting announced its debut with an architectural downlight featuring white LEDs that deliver long life, excellent energy efficiency, and unprecedented lumen output comparable to 18-26 watt compact fluorescent luminaires. [Read more on led-professional website...](#)

### Examples of Recessed Downlight Performance Using Different Light Sources

|           |  | Fluorescent*      |                          | Incandescent* |           | LED**             |
|-----------|--|-------------------|--------------------------|---------------|-----------|-------------------|
|           |  | 26W pin-based CFL | 15W R-30 CFL Edison base | 65W R-30      | 100W A-19 | LED 15W Downlight |
| LAMP      | Rated lamp lumens                        | 1800              | 750                      | 755           | 1700      | unknown           |
|           | Lamp wattage (nominal W)                 | 26                | 15                       | 65            | 100       | 9 × 1W LEDs       |
|           | Lamp efficacy (lm/W)                     | 70                | 50                       | 12            | 17        | 45                |
| LUMINAIRE | Luminaire efficiency                     | 50%               | 90%                      | 90%           | 50%       | unknown           |
|           | Delivered light output (lumens), initial | 900               | 675                      | 680           | 850       | 300               |
|           | Luminaire wattage (nominal W)            | 27                | 15                       | 65            | 100       | 15                |
|           | Luminaire efficacy (lm/W)                | 33                | 45                       | 10            | 9         | 20                |

\* Based on photometric data for commonly available products. Actual product performance depends on reflectors, trims, lamp positioning, and other factors. Assumptions available from PNNL.

\*\* Based on one commercially-available product tested. Other LED-based downlights may differ. Lamp efficacy for the LED product refers to the manufacturer listed "typical luminous flux" of the LEDs used. Luminous flux of the 9-LED array is not known.

The inherent directionality of LEDs is a potential advantage for their use in downlighting applications. If designed effectively, LED downlights could essentially eliminate luminaire light losses. LEDs also work with standard wall-mounted dimmers, unlike CFLs.

However, to approach the light output typically expected for downlights requires multiple LEDs to be grouped together. Clustering LEDs in the relatively small downlight package generates considerable heat. Actual light output depends on good thermal management in the fixture. If the heat is not adequately managed, LED device temperature will rise, light output will fall, and the useful life of the fixture will be disappointingly short. This concern is particularly important in residential insulated ceiling applications.

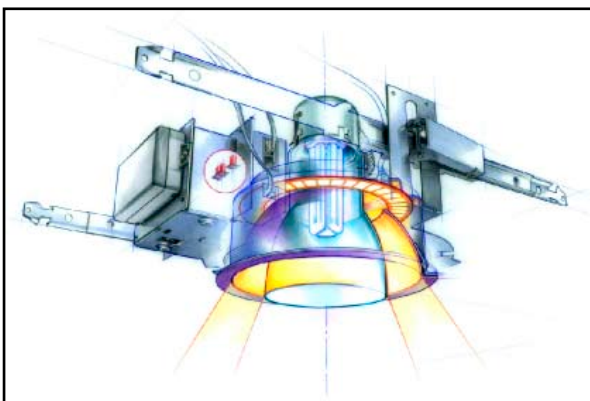

Gotham® Architectural Downlighting announced the introduction of a new decorative recessed downlight incorporating multicolor Light Emitting Diode (LED) technology. The new product, Candéo® LED, draws inspiration from the successful Candéo compact fluorescent product introduced by Gotham in 2003. [Read more on led-professional website...](#)

LED downlights available to date provide about half the delivered light output of downlights using 65W R incandescent or 15W reflector CFLs. However, as LED technology and product designs mature, LEDs are expected to compete favorably with traditional light sources in downlighting applications.

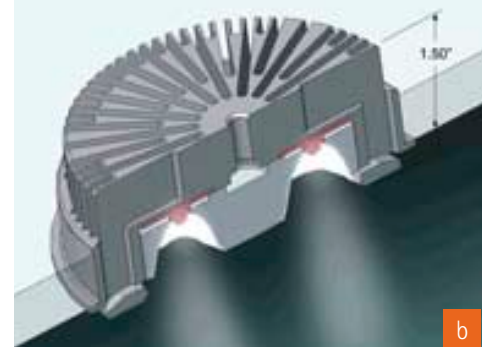

During a two-year project, the LRC developed and evaluated a low-profile LED downlight to replace a less efficient incandescent luminaire in an elevator application.

- a) The prototype LED downlights installed in an elevator on the Rensselaer campus. At the same interior light level, the fixtures showed 45% energy savings over the incandescent downlights they replaced.
- b) The low profile of the fixture (1.5 inches tall) allows it to be used in small spaces, or can allow manufacturers to reduce the space necessary to fit lighting.
- c) The LED prototype downlight designed by the LRC for passenger elevators.



## Comparison of Recessed Downlight Lamping Options

|                        | Advantages  | Disadvantages  |
|------------------------|---|--|
| Incandescent Reflector | <ul style="list-style-type: none"> <li>• Dimmable</li> <li>• High color quality</li> <li>• Low lamp cost</li> </ul>   | <ul style="list-style-type: none"> <li>• High wattage</li> <li>• Short life (2000 hrs)</li> <li>• Heat increases cooling load</li> </ul>   |
| CFL Reflector          | <ul style="list-style-type: none"> <li>• High efficacy</li> <li>• Long life (6000-8000 hrs)</li> </ul>  | <ul style="list-style-type: none"> <li>• Few dimmable products</li> <li>• More expensive than incand.</li> </ul>   |
| CFL Pin-based          | <ul style="list-style-type: none"> <li>• High efficacy</li> <li>• Long life (10000 hrs)</li> </ul>  | <ul style="list-style-type: none"> <li>• Few dimmable products</li> <li>• More expensive than incand.</li> <li>• Replacement lamps can be difficult to find</li> </ul>   |
| LED Downlight          | <ul style="list-style-type: none"> <li>• Dimmable</li> <li>• Potentially long life</li> <li>• Lower wattage than incand.</li> <li>• Directional light source</li> </ul> | <ul style="list-style-type: none"> <li>• Relatively low light output*</li> <li>• Expensive to purchase*</li> <li>• Very sensitive to high-temperature environment*</li> <li>• Replacement lamps not available</li> </ul> |

\*Listed disadvantages reflect current status of LED technology (Nov 2006). Expected technology improvements in coming years will mitigate and possibly eliminate these disadvantages.

In conclusion, recessed downlighting is potentially a good application for LEDs, when the technology matures. As new LED downlights are introduced on the market, they should be evaluated carefully, keeping the following considerations in mind:

- The light output of current LED downlights may be 25% to 50% lower than standard incandescent and CFL downlights. The overall room lighting design will need to account for this.
- Ask the LED downlight manufacturer about measured performance of the luminaire in insulated ceilings. Does the luminaire design adequately manage the heat? If such performance information is not available, it may be best to avoid LED use in insulated ceiling, airtight (ICAT) conditions.

### Sources:

US Department of Energy (DOE): LED Application Series Recessed downlights  
 Pacific Northwest National Laboratory (PNNL): The CFL Downlights Project  
 Lighting Research Center (LRC): Low-Profile LED Fixtures for Elevators

# White LEDs and Modules for General Lighting

> Paul Hartmann, TridonicAtco Optoelectronics GmbH,  
Technologipark 10, A-8380 Jennersdorf, Austria

The present discussion on the environmental effects of excessive energy disposal and the threat of global warming stresses, among other topics, the quite inefficient light sources that are still widely used for general lighting. Replacement of incandescent bulbs or even halogen lamps by more efficient technologies has already been called for. Solid-state technology has replaced the conventional thermionic technology in most relevant fields. Starting with the transistors in the 1950's the possible miniaturization lead to a revolution in electronics by enabling higher and higher package densities of circuit structures. In the field of lighting a similar process is now underway. Light-emitting diodes have long surpassed incandescent light sources in efficiency (see Fig. 1) and have achieved good colour rendering, but still lack significant penetration of the general lighting market. Reasons are the lack of the combination of these qualities and consistent colour control, and of course, cost. But owing to recent increases in efficiency and in power density offering higher lumens per Euro to the end application, they are now on the doorstep of market entry. In the long run, an electro-optical conversion efficiency of >50 lm/W is needed to materialize significant energy savings. A widespread breakthrough will be possible with a 100 lm/W white light LED target.

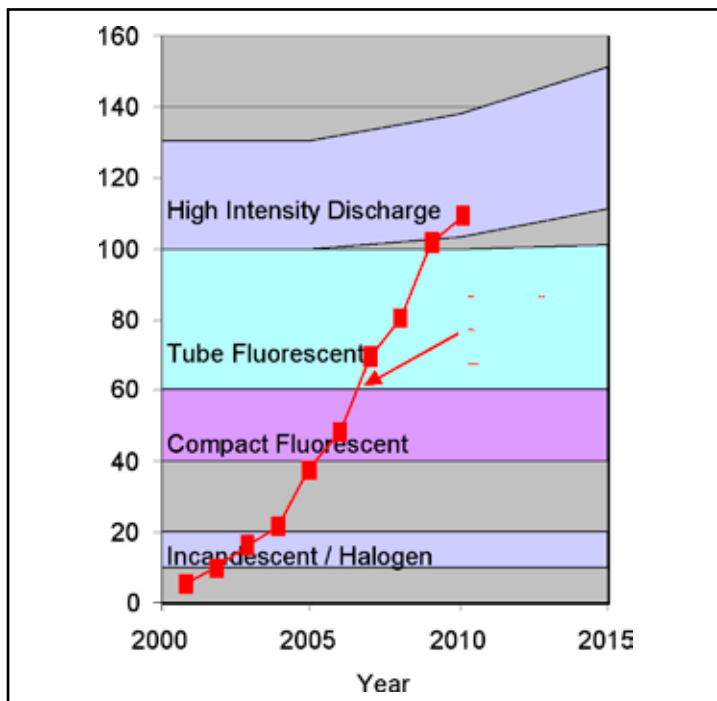

Fig. 1: Haitz' Law of efficiency increase of LED technology, versus other lighting technologies

In addition to high efficiency the requirements of general lighting applications also include high colour homogeneity over the whole illumination field (which is especially challenging for grazing wall washer applications), little to no colour and intensity shifts in the ambient temperature range, or high batch-to-batch reproducibility of colour temperatures and coordinates. Chip-on-board (COB) technology provides significant advantages over surface mount technology (SMT) components in the design of modules that allow for highly flexible illumination solutions at a high performance level. These benefits include a better temperature management, smaller size of lumen packages, and lower production costs. COB technology uses bare LED dice from the wafer and places them by die and wire bonding processes directly on a printed circuit boards (PCB). Packaged modules of this type may have various sizes and contain one to many dice, if necessary closely packed. A polymer layer is typically placed above the dice and wires for protection. Advantageously, silicone (PDMS) is used as the coating material due to its low photodegradation.

In case of white LEDs the polymer layer may contain a phosphor for colour conversion of a UV or blue LED die to deliver a broad spectrum of white light.

Advanced modelling of thermal and optical properties of LEDs and LED-modules (i.e. clusters of LED-dice on custom-designed circuit boards in COB technology) is helpful to optimise the performance of the products with respect to the general lighting requirements. To realise high brightness LED applications the trend is to employ high power LEDs having more than 1 W of power consumption. Driving currents of 350-700mA are already standard and even more than 1000mA per LED have been specified by some manufacturers. The chip size is in the order of 1mm<sup>2</sup>, thus, power densities of 2-4 W/cm<sup>2</sup> are already common. This calls for a better thermal management since the internal quantum efficiency of LEDs (especially at such high currents) is still comparatively low and the excess heat needs to be removed effectively to maintain the high lifetime of the device. Our approach aims to minimize the thermal resistance  $R_{th}$  of the structures from the LED junction to the cooling body while at the same time it ensures proper lateral heat dissipation through the PCB.

Key to white light performance is the colour conversion phosphor system. While many suppliers still use YAG based phosphors the Tridonic products rely on (Ba, Sr, Ca)-Orthosilicates that are doped with Europium.

Typically two to three different phosphors are mixed together in a single pre-polymer solution to provide optimum spectral performance. In addition, scattering particles and fillers are added to adjust light homogeneity and viscosity, respectively. The emission of the blue LED source overlaps with the phosphor emission (typically in the green, yellow and red spectral regions) to produce white light. Together with a flexible production approach that employs dedicated phosphor combinations for each wavelength bin of the underlying blue LED we are able to create superior batch-to-batch homogeneity without the need of binning.

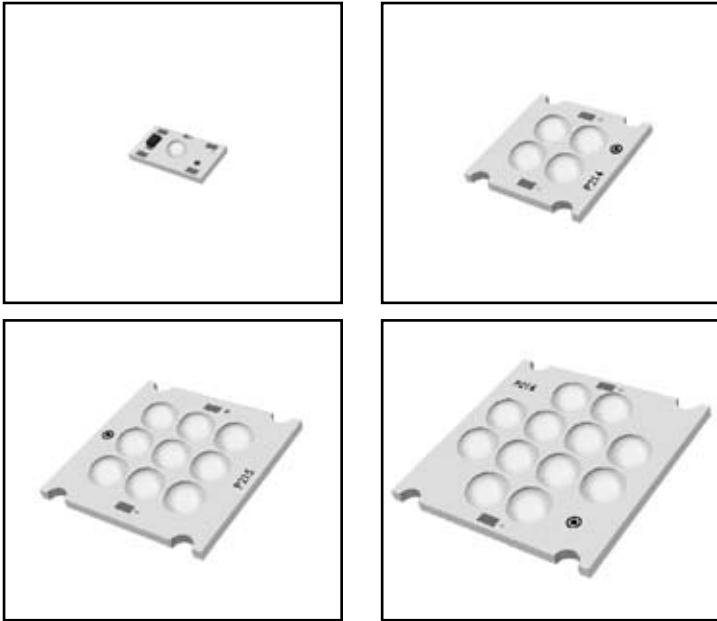

Fig. 2: LED modules for general lighting showing 1, 4, 9, or 12 white LED-points in a range of Fv = 50 lm to 1200 lm

In targeting the general lighting market with latest generation of white high-power modules we provide colour temperatures of 3000K, 4200K, and 6500K. Figure 2 shows a series of prototype modules that can be driven at 350mA or 700mA and is providing lumen packages starting from 50 lm (1 spot @ 3000K, 350mA, 1.2W) to as much as 1200 lm (12 spots @ 6500K, 700mA, 27W), a value that corresponds to the luminous flux of a modern 75 W halogen light source. The luminous efficiency is between 35 and 60 lm/W depending on colour temperature and driving current.

### The thermal simulation of a 12-spot module driven at 700mA on a typical aluminium heat sink is shown in Figure 3.

To achieve the efficiency goals of the future, the semiconductor industry has the biggest tasks since the quantum efficiencies of suitable phosphors are quite high already, while the photon conversion efficiency within the semiconductor layers of the LEDs still has a higher potential.

With respect to colour rendering there is a lively discussion going on over the applicability of colour rendering index (CRI) concepts nowadays used for fluorescent, incandescent and other light sources. The special properties of white LEDs based on available phosphors set some limitations to reach the highest possible CRI for phosphor based LEDs, but a CRI of 80 is state-of-the art, and >90 seems to be feasible within the next years, even in the warm white colour temperature range.

The required homogeneity of emission over a wide angle is a feature where optical modelling may contribute a lot. Improved light extraction and conversion, optimised scattering, and light guiding by primary optical elements will remain key for successful research and development since the achievable results are directly influencing the performance of

the products. Improved production processes capable of generating conformal coatings or similar structures that improve light homogeneity and output efficiency are already managed, while the future will see other and maybe nanoscale processes that directly influence the chip design for optimisation of white light generation by LEDs.

On a larger scale, functional forward integration of different functions is leading the path from the semiconductor dice to the finished luminaire.

The author gratefully acknowledges the contribution of the teams at TridonicAtco Optoelectronics, and the Institute of Nanostructured Materials and Photonics, Joanneum Research, both of Austria.

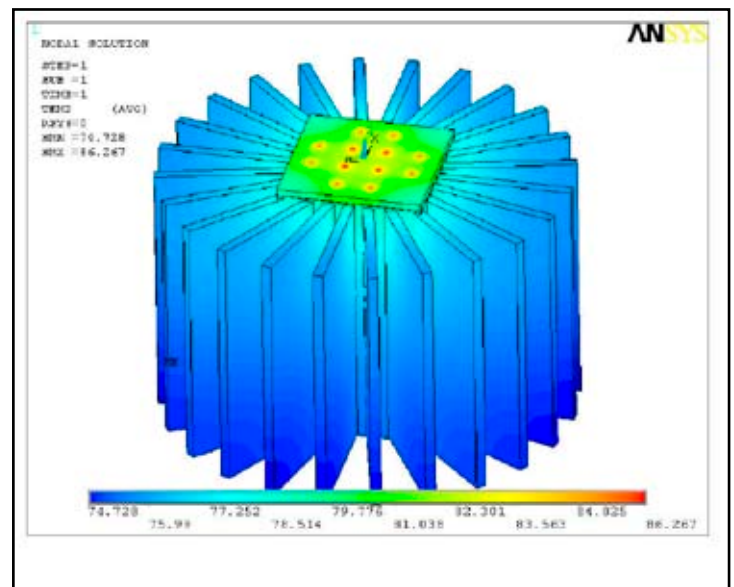

Fig. 3: Temperature distribution of a 12-LED module driven at 700mA, mounted on an aluminium heat sink.

## Next LED professional Review

# Emphasis on LED Electronics

Please contact us for advertisements, articles, reports etc. at [editors@led-professional.com](mailto:editors@led-professional.com)

# powerLED EOS. The new generation with a bright future.

[www.tridonicatco.com](http://www.tridonicatco.com)

The new generation of powerLED EOS from TridonicAtco shows just what powerLED can do. powerLED EOS modules offer exceptional luminous flux, excellent colour rendering and very narrow colour tolerances. Precisely what you'd expect from TridonicAtco. This new power category opens up entirely new applications – for example in general lighting. The innovative lens ensures that as much light as possible is made available where it is needed.



powerLED EOS  
P211 with lens



powerLED EOS  
P211

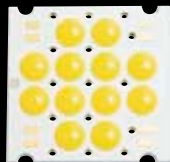

powerLED EOS  
P216

a world of bright ideas®

**TRIDONIC.ATCO**



# Lifetime of White LEDs

One of the main "selling points" of LEDs is their potentially very long life. Do they really last 50,000 hours or even 100,000 hours? This fact sheet discusses lumen depreciation, measurement of LED useful life, and the features to look for in evaluating LED products.

## Lumen Depreciation

All electric light sources experience a decrease in the amount of light they emit over time, a process known as lumen depreciation. Incandescent filaments evaporate over time and the tungsten particles collect on the bulb wall. This typically results in 10-15% depreciation compared to initial lumen output over the 1,000 hour life of an incandescent lamp.

In fluorescent lamps, photochemical degradation of the phosphor coating and accumulation of light-absorbing deposits cause lumen depreciation. Compact fluorescent lamps (CFLs) generally lose no more than 20% of initial lumens over their 10,000 hour life. High-quality linear fluorescent lamps (T8 and T5) using rare earth phosphors will lose only about 5% of initial lumens at 20,000 hours of operation.

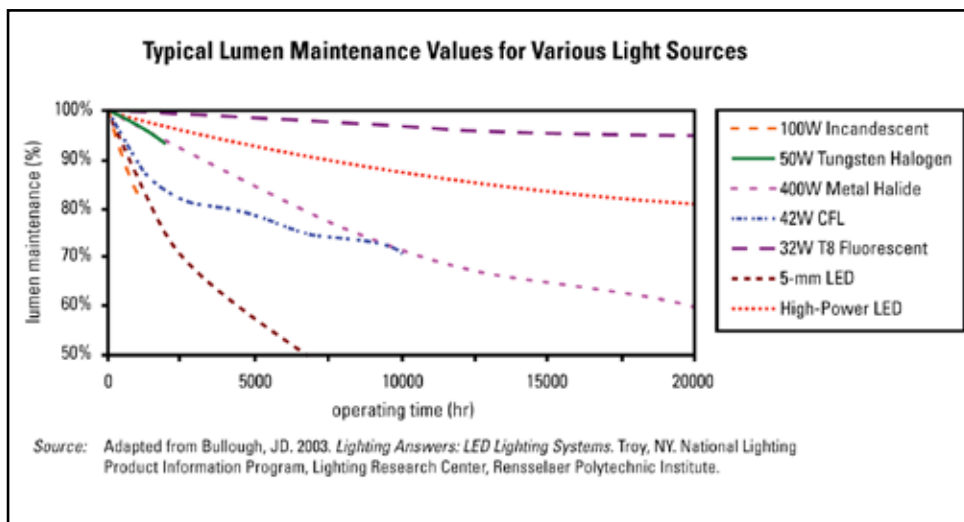

The primary cause of LED lumen depreciation is heat generated at the LED junction. LEDs do not emit heat as infrared radiation (IR), so the heat must be removed from the device by conduction or convection. Without adequate heat sinking or ventilation, the device temperature will rise, resulting in lower light output. While the effects of short-term exposure to high temperatures can be reversed, continuous high temperature operation will cause permanent reduction in light output. LEDs continue to operate even after their light output has decreased to very low levels. This becomes the important factor in determining the effective useful life of the LED.

## Defining LED Useful Life

To provide an appropriate measure of useful life of an LED, a level of acceptable lumen depreciation must be chosen. At what point is the light level no longer meeting the needs of the application? The answer may differ depending on the application of the product. For a common application such as general lighting in an office environment, research has shown that the majority of occupants in a space will accept light level reductions of up to 30% with little notice, particularly if the reduction is gradual.<sup>1</sup> Therefore a level of 70% of initial light level could be considered an appropriate threshold of useful life for general lighting. Based on this research, the Alliance for Solid State Illumination Systems and Technologies (ASSIST), a group led by the Lighting Research

<sup>1</sup>Rea MS (ed.) 2000. *IESNA Lighting Handbook: Reference and Application*, 9th ed. New York: Illuminating Engineering Society of North America. Knau H. 2000. Thresholds for detecting slowly changing Ganzfeld luminances. *J Opt Soc Am A* 17(8): 1382-1387.

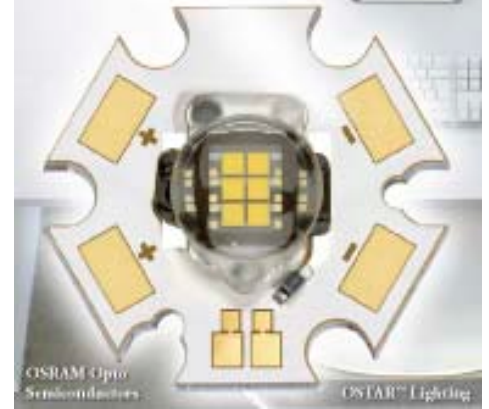

## Terms

**Lumen depreciation** - the decrease in lumen output that occurs as a lamp is operated.

**Rated lamp life** - the life value assigned to a particular type lamp. This is commonly a statistically determined estimate of average or median operational life. For certain lamp types other criteria than failure to light can be used; for example, the life can be based on the average time until the lamp type produces a given fraction of initial luminous flux.

**Life performance curve** - a curve that presents the variation of a particular characteristic of a light source (such as luminous flux, intensity, etc.) throughout the life of the source. Also called lumen maintenance curve.

Source: Rea 2000.

## Checklist

What features should you look for in evaluating the projected lifetime of LED products?

- Does the LED manufacturer publish thermal design guidance?
- Does the lamp design have any special features for heat sinking/thermal management?
- Does the fixture manufacturer have test data supporting life claims?
- What life rating methodology was used?
- What warranty is offered by the manufacturer?

Center (LRC), recommends defining useful life as the point at which light output has declined to 70% of initial lumens (abbreviated as  $L_{70}$ ) for general lighting and 50% ( $L_{50}$ ) for LEDs used for decorative purposes. For some applications, a level higher than 70% may be required.

## Measuring Light Source Life

The lifetimes of traditional light sources are rated through established test procedures. For example, CFLs are tested according to LM-65, published by the Illuminating Engineering Society of North America (IESNA). A statistically valid sample of lamps is tested at an ambient temperature of 25° Celsius using an operating cycle of 3 hours ON and 20 minutes OFF. The point at which half the lamps in the sample have failed is the rated average life for that lamp. For 10,000 hour lamps, this process takes about 15 months.

Full life testing for LEDs is impractical due to the long expected lifetimes. Switching is not a determining factor in LED life, so there is no need for the on-off cycling used with other light sources. But even with 24/7 operation, testing an LED for 50,000 hours would take 5.7 years. Because the technology continues to develop and evolve so quickly, products would be obsolete by the time they finished life testing.

The IESNA is currently developing a life testing procedure for LED products, based in part on the ASSIST recommends approach. The proposed method involves operating the LED component or system at rated current and voltage for 1,000 hours as a "seasoning period." This is necessary because the light output actually increases during the first 1,000 hours of operation, for most LEDs. Then the LED is operated for another 5,000 hours. The radiant output of the device is measured at 1,000 hours of operation; this is normalized to 100%. Measurements taken between 1,000 and 6,000 hours are compared to the initial (1,000 hour) level. If the  $L_{70}$  and  $L_{50}$  levels have not been reached during the 6,000 hours, the data are used to extrapolate those points.

## LED Lifetime Characteristics

How do the lifetime projections for white LEDs compare to traditional light sources?

| Light Source              | Range of Typical Rated Life (hours)*<br>(varies by specific lamp type) | Estimated useful Life<br>( $L_{70}$ ) |
|---------------------------|--|---------------------------------------|
| Incandescent              | 750-2,000  |                                       |
| Halogen incandescent      | 3,000-4,000  |                                       |
| Compact fluorescent (CFL) | 8,000-10,000   |                                       |
| Metal halide              | 7,500-20,000   |                                       |
| Linear fluorescent        | 20,000-30,000  |                                       |
| High-Power White LED      |  | 35,000-50,000                         |

\*Source: lamp manufacturer data.

Electrical and thermal design of the LED system or fixture determine how long LEDs will last and how much light they will provide. Driving the LED at higher than rated current will increase relative light output but decrease useful life. Operating the LED at higher than design temperature will also decrease useful life significantly.

Most manufacturers of high-power white LEDs estimate a lifetime of around 30,000 hours to the 70% lumen maintenance level, assuming operation at 350 milliamps (mA) constant current and maintaining junction temperature at no higher than 90°C. However, LED durability continues to improve, allowing for higher drive currents and higher operating temperatures. Specific manufacturer data should be consulted because some LEDs available are rated for 50,000 hours at 1000 mA with junction temperature up to 120°C.<sup>2</sup>

<sup>2</sup>Philips Lumileds Lighting. LUXEON K2 Emitter Datasheet DS51 (5/06)

## For Program Information on the Web:

www.buildings.gov  
www.netl.doe.gov/ssl

## For Information on the Next Generation Lighting Industry Alliance:

www.nglia.org

## For Program Information:

Kelly Gordon

Pacific Northwest National Laboratory

Phone: (503) 417-7558

E-mail: kelly.gordon@pnl.gov

# Efficacy and colour impression of white LEDs

> Arno Grabher-Meyer, LED professional

The die emits blue or ultraviolet light of narrow bandwidth. Wavelength converting materials (phosphors) absorb a part of the primary radiation and emit light of another wavelength. The mixed light appears white for the human eye.

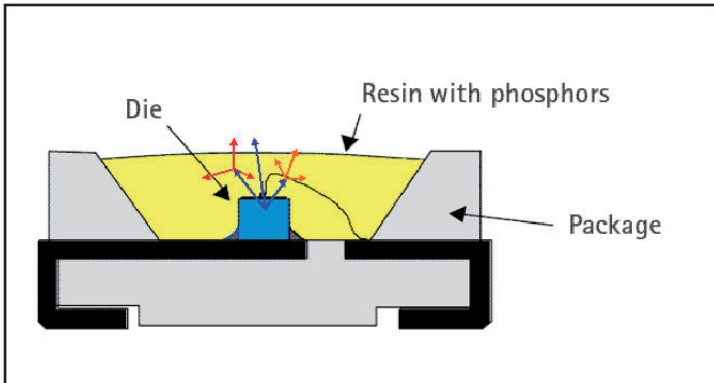

## Efficacy

Efficacy depends on different parameters. At a CCT (Correlated Colour Temperature) of 6500K or higher efficacy usually is better than at 4000K or less, because a part of the visible spectrum is produced by wavelength converting phosphors. Losses increase with amount of converted light and with the difference between the primary and secondary wavelengths. Quantum efficiency is depending on the phosphor type as well. Operating a LED with a higher current and at higher Junction Temperature ( $T_j$ ) lowers efficacy dramatically.

## Colour impression

Objects illuminated with LEDs of the same CCT can look quite different, because CRI (Colour Rendering Index) is different. The CRI is a number from 0 to 100 showing the spectral match of the light emitted by a light source with the planckian radiator (black body) at the same CCT. Even with the same CRI the appearance of illuminated objects can be different, because the divergence can be caused by different wavelength or by radiating more or less light of a specific wavelength than the planckian radiator. Colour homogeneity can be very different over the angle of light distribution. Homogeneity depends strongly on the technology and quality of dispersing phosphors over the LED die.

## White LED Manufacturer

|   |  |
|---|--|
| A-Bright Industrial Co Ltd                  | <a href="http://www.a-bright.com.tw">www.a-bright.com.tw</a>   |
| Advanced Optoelectronic Technology Inc.     | <a href="http://www.aot.com.tw">www.aot.com.tw</a>   |
| American Bright Optoelectronics Corporation | <a href="http://www.americanbrightled.com">www.americanbrightled.com</a>   |
| American Opto Plus LED Corp.                | <a href="http://www.aopinc.net">www.aopinc.net</a>   |
| Avago Technologies                          | <a href="http://www.avagotech.com">www.avagotech.com</a>   |
| Bivar, Inc.                                 | <a href="http://www.bivar.com">www.bivar.com</a>   |
| Bright LED Electronics Corp.                | <a href="http://www.brightled.com.tw">www.brightled.com.tw</a>   |
| China Semiconductor Corporation             | <a href="http://www.csctw.com.tw">www.csctw.com.tw</a>   |
| Citizen Electronics Co. Ltd                 | <a href="http://www.c-e.co.jp/e/products/pro.html">www.c-e.co.jp/e/products/pro.html</a>   |
| COTCO International Ltd.                    | <a href="http://www.cotco.com">www.cotco.com</a>   |
| Cree Inc                                    | <a href="http://www.cree.com">www.cree.com</a>   |
| Dominant Semiconductors                     | <a href="http://www.dominant-semi.com">www.dominant-semi.com</a>   |
| Edison Opto Corporation                     | <a href="http://www.edison-opto.com.tw/">www.edison-opto.com.tw/</a>   |
| Everlight Electronics Co., Ltd              | <a href="http://www.everlight.com">www.everlight.com</a>   |
| Excellence Optoelectronics                  | <a href="http://www.eoi.com.tw">www.eoi.com.tw</a>   |
| Harvatek Corporation                        | <a href="http://www.harvatek.com.tw/main.html">www.harvatek.com.tw/main.html</a>   |
| Huey Jann Electronics                       | <a href="http://www.hueyjann.com.tw">www.hueyjann.com.tw</a>   |
| Hui Yuan Electronic Factory                 | <a href="http://www.hyledchina.com">www.hyledchina.com</a>   |
| Jiangsu Wenrun Optoelectronic Co., Ltd      | <a href="http://www.wenrun.com/">www.wenrun.com/</a>   |
| Kingbright                                  | <a href="http://www.kingbright-led.com">www.kingbright-led.com</a>   |
| Kouhi Technology (HK) Limited               | <a href="http://www.kouhi.com/02a.htm">www.kouhi.com/02a.htm</a>   |
| Kwality                                     | <a href="http://www.kwalityindia.com">www.kwalityindia.com</a>   |
| Lamina Ceramics, Inc.                       | <a href="http://www.laminaceramics.com">www.laminaceramics.com</a>   |
| LEDPRO                                      | <a href="http://www.ledprodisplays.com">www.ledprodisplays.com</a>   |
| LEXEDIS Lighting GmbH                       | <a href="http://www.lexedis.com">www.lexedis.com</a>   |
| Lite-On                                     | <a href="http://www.liteon.com">www.liteon.com</a>   |
| Lucky Light Electronic Co., LTD.            | <a href="http://www.lucky-light.com">www.lucky-light.com</a>   |
| Lumileds                                    | <a href="http://www.lumileds.com">www.lumileds.com</a>   |
| LumiMicro Co. Ltd                           | <a href="http://www.lumimicro.com/eng/index.html">www.lumimicro.com/eng/index.html</a>   |
| Nichia                                      | <a href="http://www.nichia.com">www.nichia.com</a>   |
| Ningbo Brightech Optoelectronics            | <a href="http://www.brightech-opto.com/main.asp">www.brightech-opto.com/main.asp</a>   |
| OSRAM Opto Semiconductors                   | <a href="http://www.osram-os.com">www.osram-os.com</a>   |
| Panasonic                                   | <a href="http://www.industrial.panasonic.com/ww/products_e/semiconductor_e/semiconductor_e.html">www.industrial.panasonic.com/ww/products_e/semiconductor_e/semiconductor_e.html</a> |
| Seoul Semiconductor Co., Ltd                | <a href="http://www.en.seoulsemicon.co.kr">www.en.seoulsemicon.co.kr</a>   |
| Sharp                                       | <a href="http://www.sharp-world.com/products/device/lineup/opto/index.html">www.sharp-world.com/products/device/lineup/opto/index.html</a>   |
| Super Bright Optoelectronics Inc.           | <a href="http://www.sboopto.com/E-About.asp">www.sboopto.com/E-About.asp</a>   |
| Toyoda Gosei Co., Ltd                       | <a href="http://www.toyoda-gosei.com/led/">www.toyoda-gosei.com/led/</a>   |
| Toyolite Technologies Corporation           | <a href="http://www.toyolite.com.tw/company.htm">www.toyolite.com.tw/company.htm</a>   |
| UPEC  | <a href="http://www.u-pec.com">www.u-pec.com</a>   |

# Trends of Engineering System Evolution

> Siegfried Luger, LED professional

Genrich S. Altshuller, founder of TRIZ methodology (Russian acronym for "Theory of Inventing Problem Solving"), recognized that Engineering Systems follow well defined trends of evolution; the main parameters of a system will evolve driven by the competitive need to increase value. This article provides an overview of the trends in general and presents an example out of the LED domain.

## Generic Trends

The emergence and implementation of innovation is not random but follows specific evolutionary patterns; a set of generic trends. Analysis of historical patterns of evolution has revealed a number of Trends and Sub-trends that drive Engineering System Evolution. These Trends of Engineering System Evolution (TESE) are summarized in hierarchical order (Fig 1). More than 2 Million patents were scanned ending up in these generic laws. The recognized trends can be used to predict possible evolutionary paths for systems and provide possible problem resolution or system improvement.

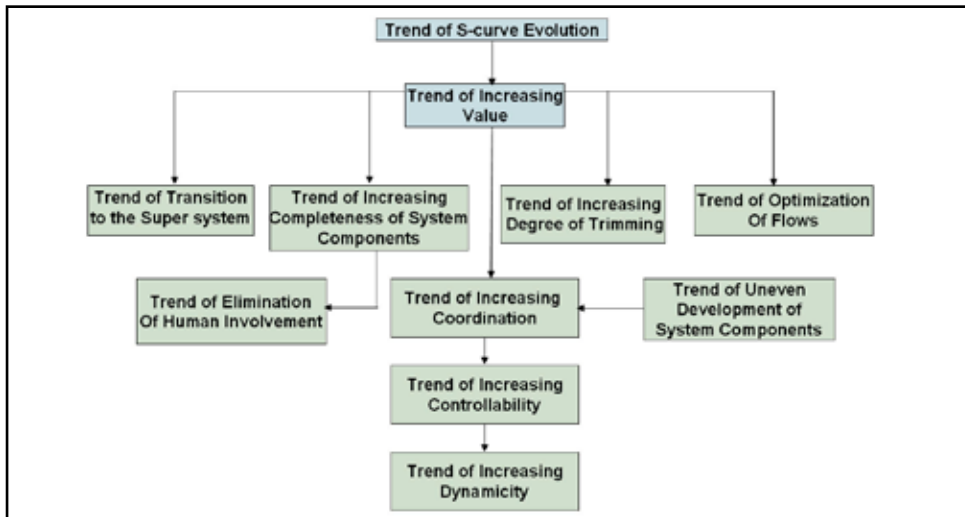

Figure 1: General Structure of TESE

## Trend of Increasing Dynamicity

As an example, let us explore the Trend of Increasing Dynamicity. As Engineering Systems evolve, they and their components become more dynamic. The law is applied to the design, the composition, the internal structure and the functions. Figure 2 shows the trend of design dynamization in which a system initiates as a monolith, adding joints, shifting over to elastic, liquid and gaseous parts and finally uses fields.



Figure 2: General Trend of Increasing Dynamicity (Design)



## Seminar on DVDs

### Systematic Innovation Seminar

If you want to learn more about Systematic Innovation and the Theory of System Evolution (TRIZ) take the opportunity of this premium introductory seminar:

**Systematic Innovation – Seminar on DVDs with MIT Prof. DDr. Sergei Ikoenko**

#### Content

- Innovation Killers
- TRIZ Basics
- Trends of System Evolution
- Problem Analysis & Identification
- 9 Screen Thinking
- S-Curve Analysis
- Contradiction Matrix & 40 Inventive Principles
- Standard Inventive Solutions
- Laws of System Evolutions
- Competitive Patent Circumvention
- Integration of Systematic Innovation into a Company

> [Click here for more information](#)



The efficiency increase is one of the major research and engineering topics in the LED field. In Figure 3 some development phases are shown related to the trend of increasing dynamism. Assuming the light beam as the design part, the system was improved by adding multiple "hinges" into the design correlated to Multi reflection, refraction and scattering in the transparent substrate, Batwing and Lambertian approaches.

To improve the efficiency further on, three development steps are left open: elastic, gaseous and field systems. An interesting research area is related to the field dynamization in which the photon generation process and the radiation angle are influenced by applying external fields to the LED die.

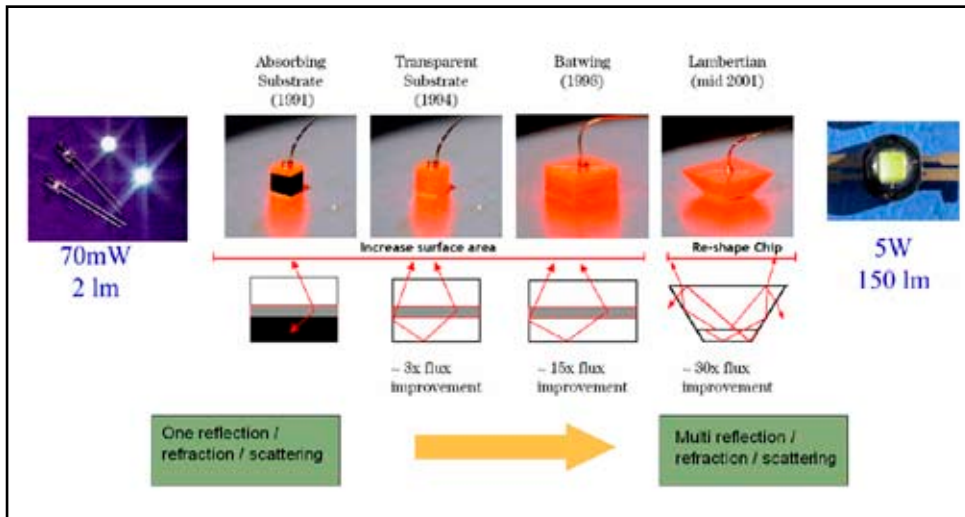

Figur 3: Trend of Increasing Dynamism - LEDs evolution for better light extraction

## Conclusions

Increasing Dynamization is an evolutionary trend of increasing control. Dynamization tends to evolve in specific ways (trends/sub trends) over time. As an engineering system evolves, it and its components become more dynamic (dynamic meaning the ability to change parameters in time).

Structures tend to evolve from rigid to hinged to multi-jointed to flexible to field. Fields evolve from constant to variable and resonant. Compositions can dynamize to become plate-like brush-like or spongy, internal structure becomes linear/non-linear, single/multi level and mono functional systems evolve to multi-functional.

Almost any system which is stiff or static will become dynamic, driven by the Law of increasing Ideality. Examination of the Trends of Engineering System Evolution can be used to predict the future development of an Engineering System or component. Knowledge of the trends of evolution can be used as a conceptual method to generate solutions to problems; it can suggest how to improve an interaction or system by considering dynamization as an inventive principle and as a future stage of evolution.

Read more about Trends of Engineering System Evolution in the next LED professional Review.

## FACT BOX

One of the TRIZ tools is called "40 inventive principles". LED professional will explain you these principles based on examples out of the LED field. You may use these principles for brainstorming about system improvements.

## Segmentation

### A. Divide an object into independent parts.

Divide the Lighting system into Supply, LED light source, Cooling system, etc.

Divide the Lighting control into central and local functions

Divide the a white LED into RGB color LEDs

### B. Make an object easy to disassemble.

Removable LED

Allow updates of LED control software

### C. Increase the degree of fragmentation or segmentation.

RGBx instead of RGB only for color mixing

Use independent LED driver instead of combined one

**Your advertisement could be here!**

**[editors@led-professional.com](mailto:editors@led-professional.com)**