

*The technology of tomorrow for general lighting applications.*

May/June 2008 | Issue

07

free version  
low resolution  
view only

Industrial Fairs  
light+building  
LIGHTFAIR INTERNATIONAL

SynJet Technology  
Photonic-Lattice Technology



**EVERLIGHT**

LIGHTING FOREVER



# The light for a new tomorrow

**Better technology, better results.**

## Ultra Bright - High Power LEDs

Leading the way in innovation and specialty, EVERLIGHT continues to develop a broad portfolio of high-power LEDs providing high luminance and high efficiency, while satisfying the demands of today's interior and exterior lighting applications.

As a pioneer in the optoelectronic industry, our everlasting mission is to develop leading edge LEDs that brighten our world while being environmentally safe and contributing to a better life for all mankind.

More information about the company's diverse products and solid-state lighting solutions can be found at [www.everlight.com](http://www.everlight.com)



EHP-AX07



EHP-AX08



EHP-5393J



EHP-803

## From Components to Systems



This year the Light and Building trade fair in Frankfurt showed it clearly: LED lighting has made a big step forward from lighting component level to lighting system level. The integration of LEDs and their system components into general lighting system solutions, such as downlights, hybrid luminaires, office luminaires, emergency lighting, or light walls, have been accelerated. Multiple important drivers have triggered this fast development in recent years.

In the first place, increased lumen output values were needed. This could be reached with improved LED efficacy values and also based on high power LED arrays, sometimes combined with remote phosphor concepts and especially high-end cooling systems.

Secondly, the light quality has had to be improved. Nowadays single LED devices with high CRIs and warm-white color temperatures are available for fixed white light. Even lighting systems with variable CCTs are used in multiple applications. But the generation of high efficient, warm-white light with CRI values above 90 remains challenging.

In addition, a special aspect of light quality concerns the spectral and color tolerances. Now LED manufacturers support closer binning, reached by improved, selective production processes. As Steve Landau, Marcom Manager of Philips Lumileds mentioned, his company wants to decrease the binning dramatically down to MacAdams 4, resulting in a categorization of color temperatures only.

Furthermore, LED lighting depends mainly on the ability of users (e.g. OEMs) to deal with the application of LED lighting systems. In this respect, there were a lot of auspicious approaches at the Light and Building trade fair such as lighting networks, ready-to-use LED modules, ready-made thermal management modules, etc.

Finally, a new mindset has evolved, taking into account that LED lighting has to be part of an emotional lighting story in buildings instead of pure technical specifications. This change opened the way for totally new applications like concrete walls with integrated LEDs.

All in all, the Light and Building trade fair was a clear demonstration of LED lighting systems coming out of niche applications into broader areas of general and architectural lighting.

In addition to the LED technology, which was clearly the center of interest, OLED was also unveiled at the Light and Building trade fair, showing the first luminaire product worldwide: a desk lamp designed by Ingo Maurer.

The present *LED professional Review (LpR)*, issue May/June 2008, highlights project and product trends shown at the Light and Building trade fair in Frankfurt, and also points out some aspects of the next big lighting event, the LIGHTFAIR INTERNATIONAL in Las Vegas at the end of this month. Regarding technology background information, the *LpR* covers the following topics in detail: LED packaging, innovative building control systems, improved driver concepts, and a signage report.

Please send us your feedback about the *LpR* content. We would like to get your opinion on how to continuously improve our services for you. You are welcome to contribute your own editorials.

Yours Sincerely,

A handwritten signature in black ink, appearing to be 'S. Luger', written over a horizontal line.

Siegfried Luger

Publisher

## Imprint

LED professional Review (LpR)

ISSN 1993-890X

### Publisher

Luger Research

Institute for Innovation & Technology

dep LED professional

Rhombergs Fabrik

A 6850 Dornbirn, Austria / Europe

phone +43 5572 394 489

fax +43 5572 394 698

editors@led-professional.com

www.led-professional.com

### Publishing Editors

Siegfried Luger

Arno Grabher-Meyer

Chrystyna Lucyk

### Account Manager Assistant

Carmen Scambor

### Front-page picture

LUGER RESEARCH, Claudia Mesquita

### Copyrights – Luger Research

The editors make every reasonable effort to verify the information published, but Luger Research assumes no responsibility for the validity of any manufacturers, non profit organisations or individuals claims or statements. Luger Research does not assume and hereby disclaims any liability to any person for any loss or damage caused by errors or omissions in the material contained herein, regardless of whether such errors result from negligence, accident or any other cause whatsoever. You may not copy, reproduce, republish, download, post, broadcast, transmit, make available to the public, or otherwise use of LED professional Review (LpR) content without the prior written permission from Luger Research – Institute for Innovation & Technology, Austria. ■



### LED professional Review (LpR) – Subscription

#### LpR Digital Magazine – free version

- pdf download
- view only, low resolution
- private use

#### LpR Digital Magazine – full version annual subscription

- pdf download
- pictures and graphs in high resolutions, printable
- 6 issues
- access to all previous issues
- commercial use
- Euro 78.80

#### LpR Printed Magazine – annual subscription

- 6 issues
- Euro 158,40

#### Send E-mail to:

editors@led-professional.com

#### LpR Issue – Jul/Aug 2008

- LED / Solar Systems



# Content

<b>Editorial</b>	p1
<b>Imprint</b>	p2
<b>Product News</b>	p4
<b>LIGHTFAIR INTERNATIONAL 2008</b>	p12

## ■ Application

### **Forethoughts on LED Breakouts in Signage**

by M. Nisa Khan, Ph.D., LED Lighting Technologies p16

### **Integrated, Exergy-Efficient Office Solution Requires LED General Lighting**

by Dr. W. Werner, Dipl. Ing. F. Theßeling, Prof. Dr. H. Leibundgut, ETH Zürich p18

## ■ Technology

### **Photonic-Lattice Technology**

by Christian Hoepfner, Luminus Devices p20

### **Evolutionary LED Packaging for Increased Flux Density**

by Jason Posselt, LedEngin Inc. p24

## ■ Driver

### **Parallel LED Luminous Flux Variation**

by Ed Wenzel, STMicroelectronics p28

### **Low Noise in LED Driver Circuits**

by Roger Alm, Melexis p30

### **Designing with High Efficient LED Driver for LED Lighting**

by Chih-Yu Wu, Macroblock p33

### **Comparison Between Continuous (DC) and PWM LED Driving Modes**

by Laurent Massol, Arno Grabher-Meyer and Siegfried Luger, LED professional p34

## ■ Thermal Management

### **An In-Depth Look at Active Cooling Thermal Management: Synthetic Jet Technology**

by Mick Wilcox, Nuventix p36

## Advertising Index

Everlight	p C2
EDISON	p 11
LED Taiwan 2008	p 15
ROAL living energy	p 23
Power Vector	p 27
Instrument Systems	p 27
euroLED	p 32
DEX Electronic Exhibition 2008	p C3
TRIDONIC.ATCO	p C4

## Product News

### Philips Launches DayWave: Breakthrough Design Office Lighting Luminaire

At Light & Building 2008, Royal Philips Electronics (AEX: PHI, NYSE: PHG) unveiled its breakthrough design luminaire for general office lighting. Philips DayWave represents a milestone in the design of office luminaires that makes your office really stand out. Waves of light to create inspiring working spaces, enabled by LEDs.

Building on the trend to a knowledge based economy, workspace design is of increasing importance. Human factors like staff well being, motivation and retention are value drivers for today's businesses. Philips DayWave is designed for an inspirational environment that is pleasant to work in. The natural rhythm of the waves of light can be combined flexibly to suit the most varied of office spaces. An intuitive control enables the office users to adjust the light output and tone to their personal taste.

As Rene van Schooten, CEO Philips Lighting Professional Luminaires states, "With the Philips DayWave we are entering the general office lighting market with a unique LED luminaire. Philips DayWave gives architects and offices designers the flexibility to create inspiring workspaces while the users can tune the light according to taste or adjust to daylight conditions. Philips DayWave reinforces Philips' leadership in anticipating meaningful trends and realising them today."

Using LUXEON Rebel LEDs, and applying an innovative optical system, Philips DayWave delivers a uniform, high level of visual comfort compliant with the European norms for office lighting. The rapid development of LED technology will accelerate the up-take of new designs and solutions in office lighting.

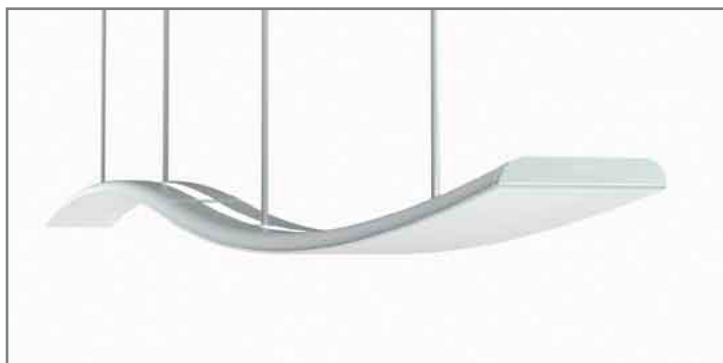

DayWave Design Office Lighting Luminaire

Philips DayWave will be available in the fourth quarter of 2008. ■

### Delta: Energy-saving High Brightness LED Lamp

Delta Electronics, Inc. announced it has developed an advanced, energy-saving High Brightness 5W/9W/12W LED Lamp, and will demonstrate the new lamp at the Light+Building 2008 exhibition in Frankfurt, April 06-11. The LED Lamp is 100% compatible with current sockets (E27) and is similar in appearance to compact fluorescent lamps (CFL) of the same wattage. The lamp is easily installed and readily replaces CFL and incandescent lamps. Advantages of the Delta High Brightness LED Lamp include: power-saving, excellent thermal dissipation & color rendering index (CRI), high efficiency, and long life. Of special note is the lamp's outstanding energy-efficiency, especially at lower environment temperatures.

"There are many companies providing LED lamps with an Edison screw base that fits E27 sockets, but these LED lamps all have a common shortcoming: they use a large heat sink for thermal dissipation from the reverse side," said Mr. Sean Chang, director of the CPBG Optical Component Business Unit at Delta. "These LED lamps are limited for use only as spot lights or down lights and either do not fit current lighting fixtures or detract from the aesthetics of the lighting fixtures. But Delta's novel heat sink design delivers 25% higher thermal dissipation than other LED lamps on the market, its appearance is similar to tungsten lamps or CFLs, and it also fits current lighting fixtures."



New E27 energy-saving High Brightness 5W/9W/12W LED Lamp

Delta's LED Lamp offers excellent luminous efficiency, superior to CFLs and 5 times higher than incandescent lamps. The 5W LED Lamp, for example, provides total luminosity equal to a 25W incandescent lamp, achieving a substantial reduction in power consumption by up to 80%. Delta's innovative heat sink design also delivers 25% higher thermal dissipation than other LED Lamps on the market. The lamp offers a CRI of up to 80%, which is much better than CFLs. Delta's LED Lamp is particularly well-suited for low temperature environments. For example, at 0°C, the efficiency of the LED Lamp is six times higher than a CFL of the same wattage. Lamp life is greater than 35000hrs, which is six times longer than CFLs and 20 times longer than incandescent lamps.

Produced under lead-free conditions, the LED Lamp is mercury-free and 100% RoHS compliant. Delta expects to bring the luminous efficacy of the LED Lamp up to 70 lm/W and add hermetic water-resistance to the design by July 2008. Delta LED Lamps are ready to take the place of CFLs. ■

## AERO HYBRID II – The Best of Two Worlds



AERO HYBRID II – The Best of Two Worlds

In unveiling its new Aero Hybrid II pendant luminaire at the Light & Building 2008, Zumtobel is presenting office lighting of the future. This new pendant luminaire combines two efficient light sources which power a system that sets new standards when it comes to lighting quality and ease of use. Aero Hybrid II combines anorganic LEDs, which provide a brilliant direct component and fluorescent lamps for direct general lighting. This hybrid design makes it possible to significantly improve the overall efficiency of the luminaire system compared with conventional luminaires using fluorescent lamps. ■

## LED-Linear: Expansion of VarioLED Flex Family

LED-Linear is pleased to introduce the expansion of its VarioLED Flex family of high luminous flux, efficiency and IP67 protected linear separable LED strips on flexible printed circuit board with self-adhesive back. VarioLED Flex includes a full line of white, warm/white, RGB and multi color lighting solutions with a full scope of accessories from power supplies to lenses. A revolutionary high efficiency, multi versatile and IP54 protected linear lighting fixture will be launched soon.

The VarioLED Flex White (W), Warmwhite (WW), monochromatic and RGB modules are easy to mount flexible, bendable and divisible lighting modules, working with 24V supply voltage. They have an extreme life span of up to 50,000 hrs and are easy and cost effective to mount due to their self adhesive back side.

The VarioLED Flex SOL will be available in white (w), warmwhite (ww) and in a white/warmwhite (w/ww) addressable solution with a significantly improved efficiency and luminous flux of up to 300 lumen per linear foot and 40 lm/w module efficiency. Besides that the white and warmwhite versions will be available with integrated lens and a radiation angle of 60° (FWHM).



VarioLED Flex Family

VarioLED Flex Dona is LED-Linear's high luminous flux and efficiency solution working with 12V supply voltage. It will be available in white, warmwhite and a high color rendering index of Ra=92, delivering a high luminous flux of up to 300 lumen per linear foot and 80 lm/w module efficiency.

All versions of VarioLED Flex will be available in an IP67 protected version of up to 6 feet length, mounted on a heat conductive aluminium profile. The IP67 LED linear modules include an outstanding protection against dust, moisture and salt water spray. All modules will also be available with an IP67 rated connector system.

As well all versions of VarioLED Flex SOL and Dona are designed to properly work with a standard lens and lensholder system available in the beam angles (FWHM) of +/- 3°, +/- 7°, +/- 6°, +/- 15°, +/- 33° and +/- 6° x +/- 24°. ■

## Fortimo LED Downlight Module



Fortimo LED downlight module with supply

With the introduction of the Fortimo LED downlight module, Philips delivers a real breakthrough in functional lighting with Solid State lighting in the office environment. The Fortimo DLM offers a breakthrough in LED energy efficiency with up to 62lm/W for the system, at 4000K, with Ra80 (a comparable LED efficiency is 110lm/W).

Fortimo is easy to integrate, maintenance free and also enables the design of extremely efficient luminaires, with only 5% efficacy losses. Fortimo is a truly environmentally friendly product, saving up to 50% in energy consumption compared to CFL downlights and providing a superior quality white light using Philips' high-power LUXEON LED technology in combination with a special patented Fortimo phosphor technology. Fortimo has a very stable and consistent colour performance (no binning limitations). Fortimo is dimmable and delivers instantly 100% light and with a lifetime of 50.000 hours. It is available in 1100 and 2000 lumen packages, providing an energy-saving alternative for a 1x18W up to 2x26W CFL downlights. ■

## RUUD: Ledway, One-Way to The Future

The way we illuminate the urban space is changing significantly. Since today it is possible to illuminate squares, streets and parking lots with the same efficiency as with the traditional lighting system, but with limited costs. This thanks to THE EDGE™, the innovative LED fixture for outdoor lighting.

Ledway is the future of LED lighting for general commercial and industrial applications – longer life, better efficiency, lower operating costs, and more environmentally friendly. THE EDGE™ currently incorporates LEDs with a color temperature of 5500K and outputs of 120 lumens per watt – two factors that make these products a viable option to replace high-intensity discharge (HID) sources.



RUUDarea: LED street light

LEDWAY products are all composed by a modular lighting system, PowerLED modules with multiple configurations, internal electronic driver. Sides made of die cast aluminium, internal IP66 compartment for electronic driver, designed for the best heat dissipation. Main body made of extruded aluminium with variable length according to quantity of PowerLED modules used.

PowerLED modules (light bars) with main support and dissipation body made of extruded aluminium, electrical circuit board and n.20 PowerLED of powered at 350mA constant current. Universal electronic driver self setting for 50-60Hz from 120V to 277V. 2 Level system option, manual and automatic. Available on request for 480V applications.

Refractors made of acrylic solids with variable geometry, integrated to the LED packages with patented NanoOptic technology with highest efficiency and total photometric control. Multi optic system, distributions according to lighting tasks.

Overall product shape slim and compact with reduced wind exposed area. Self cleaning external assembly, all parts are finished with patented Deltaguard system including cleaning, pre-treatment, chrome free e.coating and polyester powder coating, a complete and safe process delivering 10 years warranty on the finishing. Total warranty on the product: 5 years. ■

## LEDworx: „Hawk Eye“

The "Hawk Eye [3.0]" (formerly named "Falcon") new street lighting series links a novel concept for architectural street lighting with the latest LED technology.



LEDworx "Hawk Eye"

Thanks to the modular construction of "Hawk Eye [3.0]" the output can be adapted to the given lighting demands by varying the number of modules. Each module has a 40 watt output. This corresponds to 2.000 lumen light output. The modular constructions allows therefore "Hawk Eye [3.0]" street lighting up to 200 watt.

High light efficiency through the development and use of state-of-the-art technologies with low energy consumption, low maintenance costs and appealing design are the features that make the LEDworx® light truly exceptional.

Main area of application are inner and outdoor urban streets, pedestrian paths, parking lots, expressways and highways. The products from the "Hawk Eye [3.0]" series can be mounted both as pole lighting and as suspended lamps. ■



## World Premiere: Exclusive Table Light with Organic LED

The renowned lighting designer Ingo Maurer is the first to use organic LEDs (OLEDs) from OSRAM in a function table light. The light, known as "Early Future", is being produced as a limited edition. It works with tiles straight from the laboratory and demonstrates the enormous potential of OLEDs for future applications as eye-catching illumination and design elements.

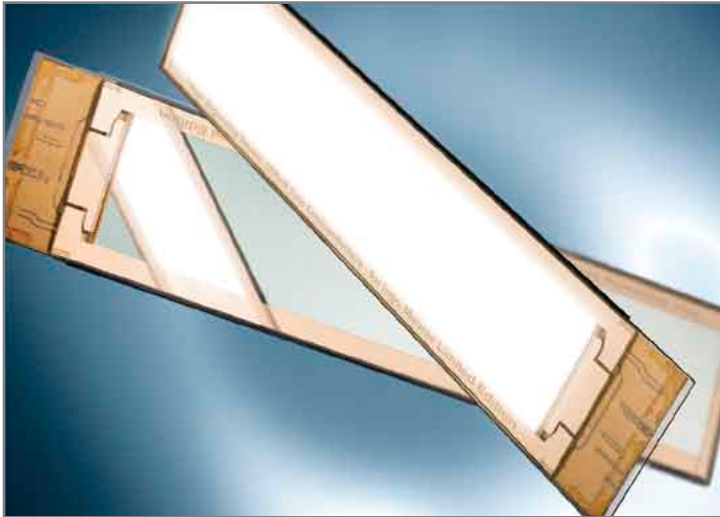

*OLED engineering samples for the Ingo Maurer table light.*

At the Light&Building fair, OSRAM Opto Semiconductors and Ingo Maurer will today unveil a revolutionary lighting application based on OLEDs. The company has made prototypes of organic light emitting diodes available to the designer for his exclusive creation. "We are proud that our OLEDs have inspired such a renowned artist as Ingo Maurer to create such an exciting work of art. "Early Future" is a vision that has become reality. It gives us a glimpse of just how versatile organic OLEDs can be in terms of their design options and applications", said Martin Goetzler, CEO of OSRAM.

Ingo Maurer used tiles with an area of 132 x 33 millimeters for his creation. For Maurer, unusual design is not an end in itself. "Early Future represents an important stage in the transition from abstract object to functional designer lighting", he said. Maurer has been shaping developments in light as art and lighting design for many years. In 1966 he exhibited the designer luminaire Bulb which has been on show in the New York Museum of Modern Art since 1969 along with other works of his. Ingo Maurer has received numerous awards for his avant-garde work with light. ■

## Havells Sylvania Extends Line of LED Products



*Concord Flat LED Panel and Concord TEC LED*

**Concord Flat LED Panels:** The new flat LED panels not only open up exciting new design opportunities – they also outperform conventional fluorescent and incandescent lamps in every department. Their white light LED technology provides uniform, low-glare lighting while reducing energy bills and overheads significantly.

The LEDs last ten times longer than CFL solutions (up to 50,000 hours) and seven times longer than conventional linear fluorescent lamps solutions. They contain no mercury, glass or filaments and emit no UV or infrared radiation whatsoever. Since they produce no heat, they can be fitted virtually anywhere and will also reduce air conditioning bills. With a wide choice of recessed or suspended modules to choose from, they are ideal for all commercial, residential, office, retail and display applications.

**Mains Voltage LED Spotlight:** Concord TEC LED is the first spotlight, powered entirely by multi-lens LEDs, to be launched by Havells Sylvania.

Measuring only 115mm square, its super slim, minimal design incorporates an array of 16 LEDs in the spotlight head. LED technology enables Concord TEC LED to have a 35,000 hours life, meaning installer can 'fit and forget', keeping maintenance costs to a minimum.

The LEDs provide the equivalent lumen output of a 100W low voltage spotlight with approximately one third of the total energy consumption. The absence of any control gear means that Concord TEC LED also has an extremely high power factor of 0.94.

As it does not project UV or IR radiation, it is ideally suited to applications where sensitive artefacts are on display. The cool white 6500K colour temperature provides excellent colour rendering and the 90° tilt and 360° rotation of the head allows fine adjustments.

Compatible with standard L1 and L3 Lytespan track systems, this mains voltage spotlight is a very discreet solution for situations where an energy efficient, near-invisible light source is required. ■

## Colour Changing LED Lighted Acrylic from Traxon/Pyrasied

Traxon Technologies and Pyrasied Xtreme Acrylic BV have agreed to intensify their collaboration in developing new illuminating concepts for architectural applications.

Architects, designers, acrylic professionals: they all seek materials in response to their ideas and wishes. And they all seek lighting capabilities to influence the atmosphere inside and outside of the architectural creations. LED lighting becomes ever more widely used in these architectural applications. Comparing with traditional illumination, energy saving LED lighting provides the opportunity to work with changing colours and colour effects.

The colour changing and intensifying capabilities of Traxon Technologies' innovative LED lighting systems and the wide variation of translucent characteristics of Pyrasied's trendiest acrylics make up a surprisingly

good match. Working with Traxon Technologies' new control system called the Light Drive, the combination of acrylics and LED lighting enables users to create diverse atmospheres to a given space. Both companies will leverage their experience for the benefits of the architectural (lighting) world.

Pyrasied Xtreme Acrylic BV represents communication between the production of the material - the semi-finished article - and the creation of a product from that material: the final article. Pyrasied therefore creates the link between the possibilities of the factories and the wishes of the designers. Various prominent European factories in the field of acrylics recognize Pyrasied's unique position in the Netherlands, thus nourishing expertise, technology, creativity and - extremely important - Pyrasied's supplies. Pyrasied brings people to the materials and we bring materials to people: architects, designers, artists, craftsmen, fellow processors of acrylics, stand builders, shop fitters, stage/set designers, discotheque fitters, model builders, display constructors, lettering makers, engraving companies and industry. ■

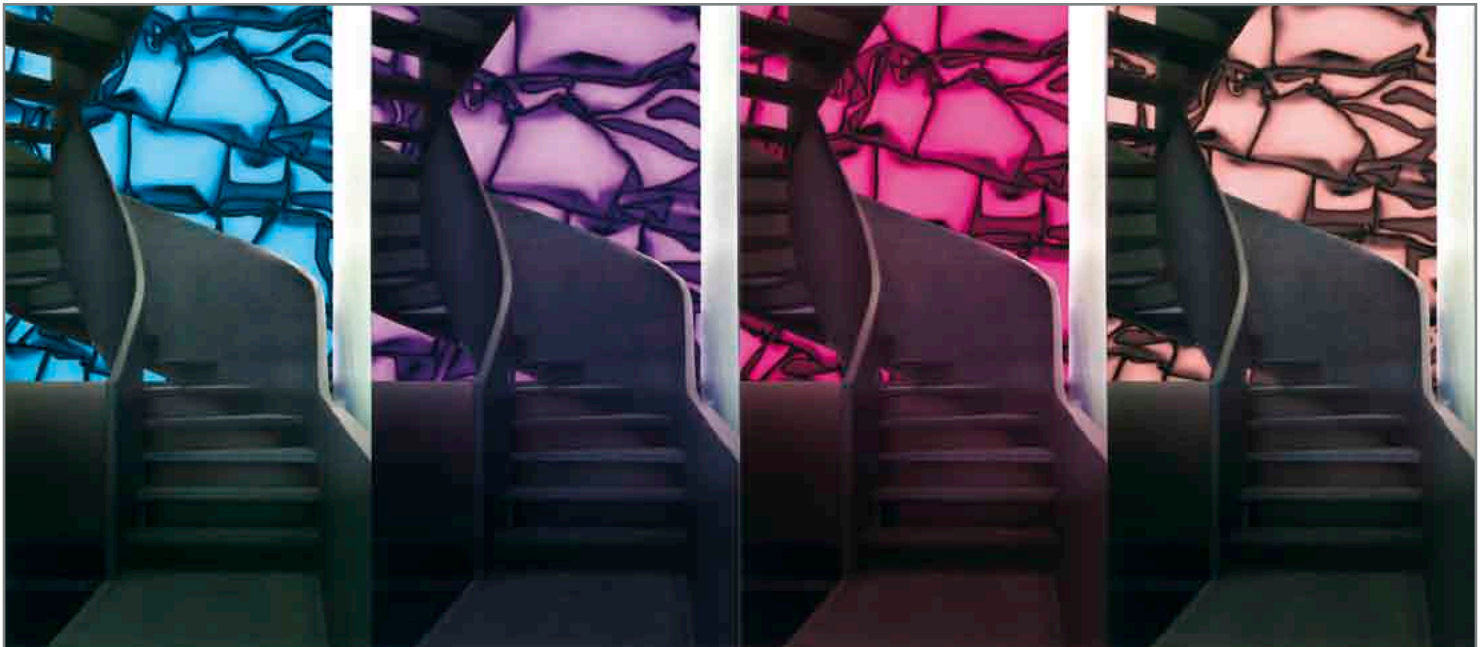

Trendiest acrylics with colour effects illuminated with Traxon LED technology

### ADVERTISING & ARTICLES

Issue	Editorial Focus	Space Close	Material Close	Pub.
Jul/Aug 2008	LED / Solar systems	Jul 11	Jul 18	Jul 31
Sep/Oct 2008	LED and luminary optics	Sep 12	Sep 19	Sep 30
Nov/Dec 2008	LED system simulation and testing	Nov 7	Nov 14	Nov 28

Editorial Calendar 2008

### LED professional Review (LpR) – Media Kit 2008

Send Email to: [editors@led-professional.com](mailto:editors@led-professional.com)  
 Ref: LpR Media Kit or call us at: +43 5572 394489

## CeramTec Expands CeramCool Opportunities – Custom Solution for Cadillac

The CeramCool® ceramic heat-sink is an effective combination of circuit board and heat-sink for the reliable cooling of thermally sensitive components and circuits. It enables the direct and permanent connection of components, such as high-power LEDs and ceramic heat-sinks. In comparison to conventional systems that mostly have numerous layers (adhesives, insulating materials) and widely varying thermal expansion coefficients, the assembly process is reduced, the device is made smaller and thermal conductivity measurably improved. Also, ceramic is electrically insulating per se and can provide bonding surfaces by using metallization pads. Long-term stability and system reliability increase.

Air cooling approaches its limits at very high power densities. This is where CeramCool® with liquid cooling comes to the fore. Coolants such as demineralized water can be used without problems. The ceramic material has excellent corrosion resistance as well. It is resistant to salt, acids and lye. Electrolytic corrosion does not occur. CeramCool® with liquid cooling. Ideal for use at very high power densities.



CeramCool® liquid cooling. Top: Conventional and CeramCool technology, Cadillac headlights

The lighting and electronics specialist Hella KGaA Hueck & Co is ready to launch serial production of the first fully LED based headlight this summer. It has been developed for the Cadillac Escalade Platinum, which is the first Sports Utility Vehicle in the world to be fitted with this trend-setting lighting technology. The high-performance multi-chip LEDs are mounted on a specially developed CeramCool ceramic frame. It is produced by the high-performance ceramics manufacturer CeramTec AG, Electronics Division, in Marktredwitz, Germany. The partially transparent

frame is produced using the dry pressing process and is then metallized. The high level of customer requirements meant that a special process had to be developed. Especially crucial to the process are the observance of the lowest tolerances and an absolutely faultless metallization. Each headlight is equipped with 7 LEDs and subsequently fitted with the ceramic CeramCool. The LED solution is particularly robust and works reliably in temperatures ranging from -40°C to + 125°C. ■

## Kramer® Lighting: Brilliant Results with LED Technology

Kramer Lighting is launching a new brand, KramerLED, utilizing groundbreaking light emitting diode (LED) innovation featuring daylight harvesting, dimming capabilities and superior light control. The new product line is for commercial indoor lighting. The latest technology allows KramerLED to use the fewest LEDs and the smallest aperture possible to maximize light output and maintain a 45-degree visual cutoff angle.

KramerLED luminaires provide a significant reduction in energy consumption and overall efficiency with equal or better performance than traditional sources. The line also features patented NanoOptic™ technology: direct contact refractors sealed to the LED dome. When used in combination with premium optical materials and advanced optical design techniques, NanoOptics provide up to 96 percent optical efficiency.

"Energy efficiency is a top priority for the lighting industry," said Kramer Lighting president Al Ruud. "The KramerLED line offers a new 'green' option for facilities working toward Leadership in Energy and Environmental Design (LEED) Certification."



KramerLED™ products: Pendant and linear LED light.

One example of this efficiency comes from KramerLED linear products. Per linear foot, linear products deliver 1,000 lumens and consume less than 20 watts with a life rating greater than 50,000 hours. These fixtures also feature dimming through zero to 10-volt control.

Energy efficiency combined with no maintenance costs or lamp replacements present KramerLED fixtures as viable alternatives to other traditional lighting sources. The complete KramerLED series includes downlight, adjustable, wall wash, direct, indirect and pendant luminaires. ■



## Flame Tip LED Chandelier Bulbs

LEDtronics® announces Flame Tip LED Chandelier Bulbs that offer beautiful lighting in many versatile applications. The DEC02-B11E25 series LED bulb comes in a flame-tip-shaped, UV-protected plastic lens covering that allows the LEDs to shine in multiple directions (three dimensions) while still being protected from the environment.

This hardy bulb is perfect in any situation that allows for 26mm Edison screw base attachments. Applications perfect for this bulb include decorative chandelier lighting. These high quality Flame Tip Chandelier LED bulbs can directly replace standard-base incandescent bulbs, allowing a long lifespan of up to 50,000 hours. Furthermore, since these bulbs are made with LEDs, they are resistant to shock and vibrations, frequent switching – they will not burn out from being switched on and off.

The best part of the DEC02-B11E25 series LED Chandelier bulbs is they only consume 2.4 watts of power while still creating so much light! These bulbs require no retrofitting kits and will install like a normal bulb, allowing you to replace old and outdated incandescent bulbs painlessly. In addition, an optional E27 European screw base is available to fit 27mm screw bases instead of the standard 26mm for volume requirements.

The Flame Tip LED Chandelier Bulb comes in warm white (3000 Kelvin) and "Filament White" (2200 Kelvin) LED light colors. Other LED light colors can be made as well and are available through custom ordering. These DEC02-B11E25 series LED Chandelier bulbs come in a 270-degree viewing angle, available with either a Water-Clear Flame Lens or Frosted Flame Lens. These DEC02-B11E25 series LED Chandelier bulbs can put out 48 lumens while still consuming only 2.4 watts!



2.4 Watts flame tip LED chandelier bulb

Solid-state design renders LEDs impervious to shock, vibration, frequent switching and environmental extremes. LED lamps operate more than 20 to 30 times longer than the equivalent incandescent lamp! Savings from reduced maintenance costs and downtime quickly return the

capital investment expenditure! LED lamps produce almost no heat and require 80% – 90% less operating power than equivalent incandescent lamps, making them as friendly to the environment as they are to the operating budget. ■

## Renaissance Lighting: HQ Commercially Produced LED Downlight

LIGHTFAIR International 2008 will become center stage when Renaissance Lighting, a pioneering innovator of solid-state LED architectural lighting, introduces the world's highest-quality commercially available solid-state LED downlight at the Renaissance Lighting booth (#1121) from May 28-30 at the Las Vegas Convention Center.

"After unveiling a lower-lumen prototype at LIGHTFAIR International in 2007, we now have the world's most versatile, highest-lumen solid-state LED downlight," said Renaissance Lighting CEO, Barry Weinbaum. "Our fixtures are brighter than ever before, yet require less energy to operate, whether it's one of our RGB downlights which are capable of 16 million colors, or our 3000k or 4100k white LED products. We believe that industry specifiers will design our fixtures into general illumination applications that solid-state lighting dared not previously address.

"All of Renaissance Lighting's products are noted for their extremely long and essentially maintenance-free lives, utilizing green technology to make them environmentally friendly. Our customers will discover that Renaissance Lighting's new initial pricing makes the decision to use our solid-state products an easier one, especially when considering the total cost of ownership.

"Our goal is to be the solid-state downlight of choice, and we have commercial, industrial and high-end residential products to do that now," Weinbaum continued. "Our solid-state lighting systems support sustainable design while allowing precise control over color and intensity, taking full advantage of what LEDs can do for lighting in today's dynamic environments."

Renaissance Lighting's unique downlight design begins with a circular array of LEDs at the perimeter of an integrating dome inside each fixture. The company's unique optic design combines light uniformly before exiting the luminaire in glare-free fashion. The result is consistent color production and concealed sources that create smooth, uniform illumination patterns.

A light-sensing feedback system continually monitors and adjusts each luminaire to factory-calibrated color standards to ensure fixture-to-fixture consistency and light quality throughout the 50,000- to 70,000-hour life of the product. The entire combination of innovative features produces the industry's purest single light source at attractively lower energy consumption levels. ■



# BEYOND • ILLUMINATION



PLCC



1~5W Edixeon® K



1~5W Edixeon® RC



3W Multi Color



1~3W Edixeon®



5~30W EdiPower®



5W EdiLine



50W EdiStar



MC PCB



10~15W P30/M26  
Module

Plant Growth

Parking

Jewelry Display

Street Light

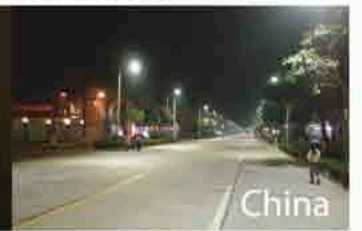
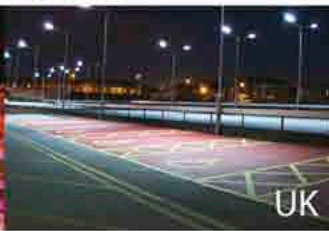

Street Light

Pub

Supermarket

School

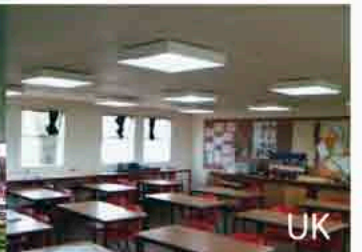

Airport

Restaurant

Museum

Musical

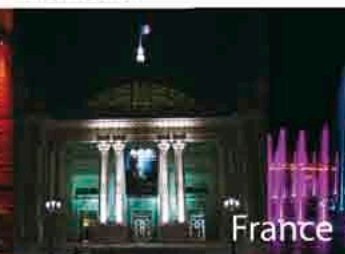

# LIGHTFAIR INTERNATIONAL 2008

## LED Product Exhibitors

Name	Booth Location	Website	Email
3E USA	Booth: 2427, LFI2008_A	www.3e-usa.com	phaak@3e-usa.com
ABRISA INDUSTRIAL GLASS, INC.	Booth: 2804, LFI2008_A	www.abrisa.com	dpuchbauer@abrisa.com
ALBEO TECHNOLOGIES, INC.	Booth: 1971, LFI2008_A	www.albeotech.com	kbettridge@albeotech.com
ANOLIS	Booth: 1531, LFI2008_B	www.robe.cz	david.chesal@robelighting.com
ANTARES LIGHTING	Booth: 2599, LFI2008_A	www.antareslighting.com	kenh@antareslighting.com
ARROW ELECTRONICS	Booth: 1941, LFI2008_A	www.lighting.arrow.com	kdonnelly@arrow.com
BARCO		www.barco.com	christine.morris@barco.com
BL INNOVATIVE LIGHTING, LTD.	Booth: 2706, LFI2008_A	www.blighting.com	bl@blighting.com
BOCA FLASHER	Booth: 1659, LFI2008_B	www.bocafasher.com	peter.park@bocafasher.com
BULBRITE	Booth: 735, LFI2008_C	www.bulbrite.com	ec@bulbrite.com
CALIFORNIA ENERGY COMMISSION	Booth: 1381, LFI2008_B	www.cltc.ucdavis.edu	mablevins@ucdavis.edu
CAO GROUP, INC.	Booth: 2281, LFI2008_A	www.caogroup.com	jennifer.baker@caogroup.com
CARCLO TECHNICAL PLASTICS	Booth: 1872, LFI2008_B	www.carclo-usa.com	jim.oconnor@carclo-usa.com
CENTRAL ELECTRONICS CO., LTD.	Booth: 2696, LFI2008_A	www.jbceled.co.kr	jbcc@chol.com
CHAUVET LIGHTING	Booth: 2797, LFI2008_A	www.chauvetlighting.com	barry@chauvetlighting.com
CIVILIGHT SHENZHEN SEMICONDUCTOR LTG. CO., LTD.	Booth: 2935, LFI2008_A	www.civilight.com	irving.pun@civilight.com
COLOR STARS, INC.	Booth: 2497, LFI2008_A	www.colorstars.com	easter@colorstars.com
CREE LED LIGHTING SOLUTIONS	Booth: 1981, LFI2008_A	www.lifinc.com	mfallon@lifinc.com
CREE, INC.	Booth: 2635, LFI2008_A	www.cree.com	deb_lovig@cree.com
DABMAR LIGHTING, INC.	Booth: 2451, LFI2008_A	www.dabmar.com	dabmar@dabmar.com
DAK LIGHTING	Booth: 2948, LFI2008_A	www.daklighting.com	davidwu@daklighting.com
DDP - ENGINEERED LED SOLUTIONS	Booth: 794, LFI2008_C	www.ddpleds.com	eugene@datadisplay.com
DIALIGHT CORPORATION	Booth: 1380, LFI2008_B	www.dialight.com	sgeyser@dialight.com
DICON FIBEROPTICS, INC.	Booth: 2893, LFI2008_A	www.diconlighting.com	qocano@diconfiber.com
DIOGEN LIGHTING, LLC	Booth: 2337, LFI2008_A	www.diogenlighting.com	katwood@diogenlighting.com
DVT GROUP	Booth: 996, LFI2008_B	www.dvtgroup.com	glenn@dvtgroup.com
ELATION LIGHTING, INC. / ACCLAIM LIGHTING, INC.	Booth: 2807, LFI2008_A	www.elationlighting.com	eric@elationlighting.com
ENERGY BRIGHT LIMITED	Booth: 1592, LFI2008_B	www.energy-bright.com	judy@energy-bright.com
ENFIS, LTD.	Booth: 892, LFI2008_C	www.enfis.com	info@enfis.com
EVERLIGHT AMERICAS, INC.	Booth: 2801, LFI2008_A	www.everlight.com	eliu@everlightinternational.com
FAWOO TECHNOLOGY	Booth: 2563, LFI2008_A	www.fawoo.com	mirakey@fawoo.com
FC LIGHTING, INC.	Booth: 1115, LFI2008_B	www.fclighting.com	jennifer@FCLIGHTING.COM
FIBEROPTIC STUDIO CORP.	Booth: 2905, LFI2008_A	www.fiberopticstudio.com	victor@fiberopticstudio.com
FRAEN CORPORATION	Booth: 2911, LFI2008_A	www.fraensrl.com	s_grzenda@fraen.com

Name	Booth Location	Website	Email
FREESCALE SEMICONDUCTOR, INC.	Booth: 2963, LFI2008_A	www.freescale.com	heidi.fitz@freescale.com
GALLIUM LIGHTING, LLC	Booth: 2776, LFI2008_A	www.galliumlighting.com	keith@galliumlighting.com
GBL LED LIGHTING, INC.	Booth: 1298, LFI2008_B	www.gbl-led.com	sales@gbl-led.com
GE CONSUMER & INDUSTRIAL	Booth: 515, LFI2008_C	www.gelighting.com	joe.desalvo@ge.com
GO LIGHTING TECHNOLOGIES, INC.	Booth: 494, LFI2008_C	www.goenergyeffective.com	r.content@goenergyeffective.com
GOLDLINE USA INC.	Booth: 1595, LFI2008_B	www.ledbricks.com	sales@ledbricks.com
ILLUMINATION MANAGEMENT SOLUTIONS, INC.	Booth: 2680, LFI2008_A	www.imslighting.com	bud@imslighting.com
ILLUMIVISION, INC.	Booth: 1915, LFI2008_A	www.illumivision.com	linda@illumivision.com
ILUMISYS	Booth: 2967, LFI2008_A	www.ilumisys.com	miesik@altair.com
INTEMATIX CORPORATION	Booth: 2642, LFI2008_A	www.intematix.com	icokgor@intematix.com
ITI GROUP, USA	Booth: 394, LFI2008_C	www.itigroupusa.com	wy@itigroupusa.com
J & J ELECTRONICS, INC.	Booth: 2627, LFI2008_A	www.colorgloledlighting.com	marketing@jandjelectronics.com
JESCO LIGHTING GROUP	Booth: 837, LFI2008_B	www.jescolighting.com	paulin@jescolighting.com
JOURNEE LIGHTING, INC.	Booth: 1215, LFI2008_B	www.jrne.com	clay@jrne.com
KHATOD USA	Booth: 2593, LFI2008_A	www.khatod.com	khatodusa@khatod.com
KUMHO ELECTRIC USA, INC.	Booth: 2435, LFI2008_A	www.kumhoelectric.com	medak@kumhoelectric.com
LAMINA LIGHTING	Booth: 2172, LFI2008_A	www.laminaceramics.com	jiannone@laminaceramics.com
LED DEPOT INC.	Booth: 297, LFI2008_C	www.led-depot.com	sales@led-depot.com
LED LIGHTS, INC.	Booth: 2896, LFI2008_A		tedtntsolar@gmail.com
LED SMART, INC.	Booth: 2660, LFI2008_A	www.ledsmart.com	sales@ledsmart.com
LED TO LITE	Booth: 396, LFI2008_C	www.ledtolite.com	info@us-ledtolite.com
LEDDYNAMICS, INC.	Booth: 1696, LFI2008_B	www.ledynamics.com	saugustus@ledynamics.com
LEDPAC	Booth: 1590, LFI2008_B	www.ledpac.com	jack@ledpac.com
LEDTRONICS, INC.	Booth: 2758, LFI2008_A	www.ledtronics.com	jpapanier@ledtronics.com
LEHIGH ELECTRIC PRODUCTS COMPANY	Booth: 526, LFI2008_C	www.lehighdim.com	lhjones@lehighdim.com
LEOTEK ELECTRONICS USA CORP.	Booth: 890, LFI2008_C	www.leotek.com	meg@leotek.com
LIGHT ENGINE LIMITED	Booth: 2458, LFI2008_A	www.lightengine-tech.com	rosewong@lightengine-tech.com
LIGHTING FOR TOMORROW	Booth: 283, LFI2008_C	www.lightingfortomorrow.com	Eaton@cee1.org
LIGHTWILD	Booth: 1691, LFI2008_B	www.lightwild.com	tstafford@lightwild.com
LUMIFICIENT CORPORATION	Booth: 2529, LFI2008_A	www.lumificent.com	careyb@lumificent.com
LUMILENS OPTOELECTRONICS, INC.	Booth: 1694, LFI2008_B	www.lumilensopto.com	adamicskao@lumilensopto.com
MAREXIM	Booth: 1747, LFI2008_B	www.marexim.com	david.smith@marexim.com
MEYDA TIFFANY	Booth: 377, LFI2008_C	www.meyda.com	johnvella@meyda.com
MK DIGITAL DIRECT	Booth: 2943, LFI2008_A	www.mkdigitaldirect.com	enacach@mkdigitaldirect.com
MODA LIGHT	Booth: 2467, LFI2008_A	www.modalight.com	mark@modalight.com
NEO-NEON	Booth: 2443, LFI2008_A	www.neo-neon.com	susan@nn-america.com
NEOPAC OPTOELECTRONICS, INC.	Booth: 2901, LFI2008_A	www.neobulb.com	eric.yeh@neopac-lighting.com
NEXXUS LIGHTING, INC.	Booth: 2535, LFI2008_A	www.nexuslighting.com	rheiner@nexuslighting.com
NICHIA AMERICA CORPORATION	Booth: 127, LFI2008_C	www.nichia.com	linda.trotter@nichia.com
NORTH AMERICAN ENERGY GROUP	Booth: 1894, LFI2008_B	www.naeg.com	s.george@naeg.com



Name	Booth Location	Website	Email
OMNITRONIX ENGINEERING, LLC	Booth: 1697, LFI2008_B	www.omnitronix-engineering.com	gm@omnitronix-engineering.com
OPTEK TECHNOLOGY	Booth: 2980, LFI2008_A	www.optekinc.com	rparks@optekinc.com
OPTILED TECHNOLOGY, LLC	Booth: 2315, LFI2008_A	www.optiled.com	jrobertson@optiledtech.com
OSRAM SYLVANIA	Booth: 559, LFI2008_C	www.sylvania.com	robert.sweeney@sylvania.com
PERKINELMER OPTOELECTRONICS	Booth: 2507, LFI2008_A	www.optoelectronics.perkinelmer.com	anthony.lauletta@perkinelmer.com
PHILIPS LIGHTING COMPANY	Booth: 759, LFI2008_C	www.philips.com	cicely.whetstone@philips.com
PHILIPS SOLID-STATE LIGHTING SOLUTIONS	Booth: 1721, LFI2008_B	www.colorkinetics.com	lsones@colorkinetics.com
POWER VECTOR	Booth: 1498, LFI2008_B	www.powervector.com	lpetrov@powervector.com
RENAISSANCE LIGHTING, INC.	Booth: 1121, LFI2008_B	www.renaissancelighting.com	kwillmorth@rllight.com
REVLITE TECHNOLOGIES, INC.	Booth: 2035, LFI2008_A	www.revlite.com	wallace.quan@revlite.com
SAMSUNG ELECTRO-MECHANICS CO., LTD.		www.sem.samsung.com	yunhg@samsung.com
SEACHANGER BY OCEAN OPTICS, INC.	Booth: 2621, LFI2008_A	www.seachangeronline.com	beth.weinstein@oceanoptics.com
SELF ELECTRONICS CO., LTD.	Booth: 1935, LFI2008_A	www.self.cn	chenhw@self.cn
SEOUL SEMICONDUCTOR CO., LTD.	Booth: 233, LFI2008_C	www.zled.com	ashley@zled.com
SICHUAN JIUZHOU ELECTRIC GROUP CO., LTD.	Booth: 2813, LFI2008_A	www.jiuzhou.com.cn	lbmar@jiuzhou.com.cn
SKOFF SP Z O.O.	Booth: 1599, LFI2008_B	www.led.skoff.com.pl	karina.skiba@skoff.pl
THE LED COMPANY	Booth: 2431, LFI2008_A	www.ledcohome.com	cward@ledcohome.com
TIVOLI, LLC	Booth: 2917, LFI2008_A	www.tivolilighting.com	gsmith@tivolilighting.com
TMB	Booth: 2500, LFI2008_A	www.tmb.com	ba@tmb.com
TOP NANOSYS, INC.	Booth: 1899, LFI2008_B	www.topnanosys.com	skoh@topnanosys.com
TRASTAR, INC.	Booth: 2401, LFI2008_A	www.trastar.com	ptian@trastarusa.com
TRAXON USA & E:CUE LIGHTING CONTROL		www.traxon-usa.com	amy.meredith@traxon-usa.com
TRULY LED	Booth: 1499, LFI2008_B	www.trulyled.com	frogfood@msn.com
U.S. DEPARTMENT OF ENERGY CALIPER	Booth: 798, LFI2008_C	www.netl-doc.gov/comm_testing.htm	theresa.shoemaker@pnl.gov
VIRGINIA OPTOELECTRONICS, INC.	Booth: 2806, LFI2008_A	www.vaopto.com	charles.li@vaopto.com
VISTALINK, INC.	Booth: 139, LFI2008_C	www.vistalinklighting.com	keiyau@vistalinkinc.com
VOSSLOH-SCHWABE, INC.	Booth: 1347, LFI2008_B	www.vossloh-schwabe.com	todd.darrow@vsus.vossloh-schwabe.com
WE-EF LIGHTING USA, LLC	Booth: 1290, LFI2008_B	www.we-ef.com	d.nolfi@we-ef.com
WENRUN USA / JIANGSU WENRUN	Booth: 2403, LFI2008_A	www.wenrunusa.com	arnold@wenrunusa.com
XUS CORPORATION	Booth: 197, LFI2008_C	www.xuscorp.com	shelley.sorensen@gmail.com

This is an extraction showing exhibitors with a strong focus on LED products. ■





## Lighting Up Your Future !

June 11~13, 2008

Taipei World Trade Center

## LED Lighting Taiwan 2008

- The 4th International LED Lighting Exposition



### Exhibits

- **LED Lighting Fixture**  
Indoor, Outdoor, Specialty  
Decorating, Landscape, Architecture, Garden  
Control System & Accessories
- **LED Applications**  
Automotive Lamps, Backlight, Display Board,  
Traffic Signal, IrDA, etc.
- **Package / Module**  
Lamp, Dot Matrix, Cluster, SMD, etc
- **Epi Wafer, Chip**
- **Materials**  
Substrate, Ingot, Phosphor,  
Lead Frame, etc.
- **Processing Equipment**  
Wafer (MOCVD, Mask, Etching)  
Assembly (Dicing, Bonding, Packaging)  
Testing (Prober, Aging)

Organizer :



**Photonics Industry & Technology Development Association**

Overseas contact : Pamela Hsiao

E-mail : [exhibit@mail.pida.org.tw](mailto:exhibit@mail.pida.org.tw)

Tel : +886-2-2351-4026 ext. 805 Fax : +886-2-2396-8513

Show websites : <http://www.optotaiwan.com>

### Concurrent Expositions

#### Photonics Festival in Taiwan

**OPTO Taiwan 2008** The 17th Int'l Opto-electronics Exposition

**OPTICS Taiwan 2008** The 2nd Int'l Precision Optics Exposition

**SOLAR Taiwan 2008** The 2nd Int'l Solar Exposition

#### Display Taiwan 2008

The 10th Int'l Flat Panel Display Exposition

## Application

### Forethoughts on LED Breakouts in Signage

> M. Nisa Khan, Ph.D., President, LED Lighting Technologies

It is no secret that LEDs are attracting huge attention in the signage and display industries. They are widely used in such applications as billboards, large outdoor video screens, and electronic message centers (EMC), and have little competition from other technologies at this time. Although for many years, neon has dominated in channel letters and in other on-premise illuminated static signs, recently more signmakers have migrated to LED-lamped channel letters from neon tubing. (For example, see LEDs Overtake Neon by Wade Swormstedt - Signs of the Times Magazine, April 2008.) The exact neon-LED breakdown for static on-premise signs is difficult to pin down because the LED replacements as well as new LED-sign introductions are always in a state of flux. Nevertheless, an effort to determine what existing neon signs or typical neon signage applications are being replaced (or seriously being considered for replacement) by LED signs should prove to be useful for the industry because this would help the customers and vendors understand what trend is forming and the driving factors behind them. Two things are important to keep in mind, however, when such a movement is occurring: 1) sensitivity to the new technology already showing some visible or tangible benefits, and 2) assessing whether such a trend is actually beneficial overall in the long run or does it only appear so at a quick glance? The industry focus should now be to understand the real benefits of LEDs and work towards determining their actual long-term tangible benefits in cost, energy savings, easier maintenance, and attractive appearance.

#### Why the Interest in LED Signage

The LED technology has improved significantly over the past 5 to 10 years. Light output has reached a point where LEDs are viable for many applications, especially for colored light uses. More importantly, experienced LED manufacturers see improvements in light output continuing for years to come such that LEDs could make sense for virtually any lighting application. The science and engineering behind LEDs will tell us that vast improvements are still possible and likely to be realized in a few years.

Channel Letters and illuminated sign cabinets (e.g., backlit signs) are lucrative segments in the sign industry. That is precisely the reason why it is important to consider viable alternative light sources for them that may have long-term energy and maintenance-cost savings. While many channel-letter manufacturers have started to consider LEDs, they are finding that changing the source means changing such numerous other constituents as the front-face color, backing material, and transformers. In fact a whole slew of issues need to be resolved such as humidity and temperature dependence, and matching colors from bins especially when

a replacement of LED modules may be needed. Several LED manufacturers quote the LED operating lifetime to be 100,000 hours (~11 years) or more. It has become a regular debate whether this claim has any validity because LEDs used in channel letters and other signs have not been around that long. It is important to note that such lifetime is an extraction from similar accelerated temperature and aging tests that proved to be quite accurate for semiconductor lasers and LEDs that have been employed in fiber-optic telecommunication fields for over two decades. While LED scientists and engineers may rightfully claim that the chip may have a lifetime of 100,000 hours, the luminaire manufacturers still need to perform further study and measurements to demonstrate that the packaging material and driver electronics can also withstand the outdoor environment, in particular, over such lifetimes.

#### LED Penetration Possibilities

The electronic digital signage field is dominated by LED screens and new developments and applications are frequently spurting. LEDs screens are popular for large outdoor displays because they have high brightness and scale (large size), and coarse resolution satisfactory for distant viewing. The other two popular display formats, LCD and plasma, provide lower brightness but have very good resolution for close-range viewing, although not on a very large scale. Despite the fact that LCD and plasma screens are getting larger with time, for practical reasons they are likely to not get much bigger than a 100-inch diagonal, due to manufacturing and handling complexities. A new display technology known as ITrans (Screen Technology, Cambridge, UK) is now offering large displays by seamless tiling of several 17-inch LCDs that utilize fiber-optic transmission to transfer the image onto a large screen with high resolution. These displays are currently used indoors in limited quantities in high-end financial buildings and shopping malls around the world. ITrans scaling is claimed to reach in the several 10's of meters range. It will be interesting to see how various display technologies develop for both indoor and outdoor applications over the years.

As mentioned above, currently the channel letters and outdoor on-premise cabinet signs are a very large and lucrative part of the sign industry. It is hard to say how much LED penetration is happening there because LEDs are growing fast in this segment. Many vendors are already offering LED signs as neon replacements to existing customers, but more importantly, some of them are achieving success in acquiring new customers that buy into LED signs over neon signs. Since LED illumination sources can be easily scaled with additional plug-in modules, larger channel letters in higher altitudes are using them instead of neon. Although neon still captures a good portion of the sign industry, higher penetration of LEDs will likely take place in the upcoming years as LED brightness, efficacy, color quality, stability, durability, and cost performances improve.

#### Neon Counterparts

Neon signs have been around for nearly 100 years and consequently the technology is reliable and mature. Aside from the red-color, neon brightness and efficacies still surpass those of LEDs in amber, yellow, blue, green, and white in current sign systems by appreciable amounts. The

installed first cost (IFC) is significantly lower for neon compared to LEDs. Furthermore, the average lifespan of neon is 100,000-200,000 hours, which far exceeds even the highest claims for LED lifespan. One should be mindful that as LED performances improve, so will neon. Like many competing technologies, this battle will continue at least in the near term with little clarity on whether neon signs will diminish any time soon.

Neon light sources have several weaknesses however. They are not as robust as LEDs because neon tubing is made of glass that can break easily. Although a very well-established and repeatable manufacturing process, it is not a high-volume production process and cannot simply scale to large signs; some neon lamps have mercury inside that can easily exceed harmful levels because the mercury inserted in the tube is not a well-controlled process; this may prove to be fatal in the long-run. As discussed above, LEDs are expected to improve in brightness and efficacy and when enough of a performance gap gets created in favor of LEDs, the regulations on restricted energy consumption could also hurt neon.

## Areas of Attention

The LED promise is exciting – but, what will it take for the manufacturers and customers to understand and realize it? The answer is education and promotion, while being realistic about a multitude of issues. The lighting industry needs to be educated about the LED technology and find ways to bring it to the context of lighting. This will require better understanding of optical and electrical terms and parameters. This is especially important now because we live at the age of comparison. When neon unquestionably was the sole choice and energy consumption was not as much of an issue, the need for keen measurements and comparison was not very crucial. Now, the lighting designers need to understand the parameters of importance, know how to measure them, and establish methods to compare signs from different technologies. Better understanding of technical terms and appropriate application of them in real scenarios will help promote the right technologies in businesses.

One example is to understand why red-LED performance for cost, brightness, and efficacy exceeds red-neon. Krypton Neon's (Long Island City, NY) website ([www.neonshop.com](http://www.neonshop.com)) displays an excellent comparative chart, although it dates back to 2004. Under the Tech Spec header, the Comparison Tables show red neon has 25 lumens per watt, whereas red LEDs have 38 ([www.neonshop.com/Tech/compare.html](http://www.neonshop.com/Tech/compare.html)). This has to do with the fact that the 'internal quantum efficiency (IQE)' of red LEDs is inherently nearly twice that of blue LEDs. IQE yields the amount of light converted from a unit of injected current via electroluminescence. In actual numbers, the IQE for red LEDs made of aluminum indium gallium phosphide (AlInGaP) is nearly 100% whereas for blue LEDs made of aluminum indium gallium nitride (AlInGaN), it is 50%. This inherent efficiency gap between red and blue LEDs is indeed large. Understanding external quantum efficiency (EQE) that determines the actual light extracted from the LED module is also important. EQE depends on reflection, which is caused by the refractive index mismatch between air/encapsulation medium and the

semiconductor chip. The index matching as well as other surface roughening techniques to reduce reflection needs to be incorporated into the module to increase the overall efficacy (lumen/W) of the LED.

Although simple may be to some, it is important to understand the definitions, in particular physical meanings of parameters such as lumen, candle, efficacy, luminance, and illuminance. Better understanding is also needed for their interrelations when it comes to using them for relevant measurements.

For LED light output measurements and making comparisons with other light sources, it is crucial to remember that LEDs have different beam angles in horizontal and vertical directions and they are narrow; their intensity distribution (i.e. beam pattern) is also unique – so comparison over a particular space is tricky! In sum, luminaire designers need to understand the definitions, keep them straight and compare things meaningfully.

## What Is The Future?

In the world of electronic digital signage (EDS), LEDs are already ubiquitous especially for large outdoor systems. The signage industry is just at the dawn of the EDS era and various display technologies will continue to be further enhanced for indoor and outdoor uses with a wide range of scalability. LEDs will continue to play a very significant role in display technologies, whether for screens or illumination.

LEDs are currently available in red, red-orange, amber, blue, cyan, and green, and white. White LEDs are the hardest ones to manufacture and still not in par with neon. Although some manufacturers currently use white LEDs in some channel letters and other backlit sign applications, mainstream adoption in signage will require improvements in performance and cost of the white LED technology. As we continue to improve the performance of white LEDs, additional applications will make sense, including medium and large backlit signs. Aside from brightness and cost factors, LED channel lighting systems offer conveniences that will only grow in time.

We find many more companies offering LED channel letters today than we did even a few years ago. Sloan, GELcore, and ElectraLED are a few of the well-recognized suppliers of the LED channel letter market. The demand for LEDs in channel letter applications is clearly growing and will grow further as LED system companies improve their storage, installation and handling. Some manufacturers now ship their channel letter products in reels so that strips can be cut to size on premise. Installation then becomes more efficient and they can construct a wider variety of sign letter fonts with LED strips. With such establishment and further consistency over time, LED sign manufacturers can anticipate demand and plan for future growth.

The future of LEDs for channel letters and cabinet signs is very bright. Further adoption of LEDs for channel letter illumination will occur as more of its proof of performance is established. Channel letter illumination is just one of the areas where LEDs are beginning to shine – but the future for LEDs in general is really wide open. ■



# Integrated, Exergy-Efficient Office Solution Requires LED General Lighting

> Dr. Walter Werner, Dipl. Ing. FH MAS ETH Frank Theßeling,  
Prof. Dr. Hansjürg Leibundgut, ETH Zürich

## Introduction

The total CO<sub>2</sub> emissions resulting from artificial lighting equals 70% of that of automobiles and is 3 times that of air traffic. Therefore the importance of lighting systems and its impact on human perception and comfort is growing. Architects and engineers are now expected to evaluate and be aware of the psychological and physiological impacts of lighting designs on humans as well as the energy demand. By taking these measures into account in building components, a more exergy efficient office lighting design will result.

## The Institute

The Chair of Building Systems is part of the Institute of Building Technology (HBT) at the ETH Zurich. Prof. Dr. Hansjürg Leibundgut organizes research focused on the optimization of exergy flows in buildings. This involves collaborations with industry partners. In these collaborations different instruments, methods and processes are developed in which the theoretical aspects are verified. Special attention is given to the many niches of a building. Decentralized instruments can be placed in these niches, and can be integrated such that the exergy flows are minimized and the building comfort maximized.

## The Low-Ex Concept

The scientific concept for these "new" building systems is exergy. It replaces or supplements the purely energetic view.

*In thermodynamic applies: Energy = Exergy + Anergy*

In the heating case anergy is that portion of the energy (heat flow) that comes from the external environment (i.e. soil, groundwater, outside air, waste air, waste water). The utilized exergie (i.e. the drive of a heat pump) lifts the temperature level to the needed temperature. The exergy efficiency of a process  $ex = Ex_{real} / Ex_{ideal}$  is the higher the smaller the temperature drop between utilizable temperature and the anergy source is. The anergy extraction requires large investments on the part of equipment and capital; there is a large potential for economic optimization.

## A Low-Ex Ceiling Installations

Low-temperature heating systems are inherent to the system and they increase the exergy efficiency by minimizing temperature gradients. At the Chair of Building Systems a ceiling panel has been developed, that not only uses the advantages of a low-temperature system, but also implements other diverse aspects of building systems. While keeping the room at a moderate temperature the ceiling panel also works

acoustically and controls the exhaust air with decentralized, CO<sub>2</sub> steered exhaust vents. What is more, the panel also provides high efficiency primary and secondary lighting.

Conventional exhaust air systems would make the overall height for the ceiling panel larger, because a large amount of air must be constantly removed in large ducts. These exhaust ducts determine the overall height. With a CO<sub>2</sub> optimized exhaust system smaller cross sections are possible, because the air is removed only as demanded. In that case the ceiling panel can be reduced to an overall height of 9.5 cm. Along with the air exhaust system, the light system must be implemented. The overall height of the lighting system is limited to 3 cm. Conventional installation lights have more depth. In this situation the lights would dictate the height of the ceiling panel. From the architectural point of view it is useful to use flat ceiling panels because they provide more flexibility in space utilization. Along with spatial improvements the LED cove lighting of the flat ceiling panel improves the indoor atmosphere, which leads to an increased work productivity.

## LED Support for Low-Ex Installation

Three-Way use of the LED technology: By installing the LED lights into the air exhaust system their heat load can be taken directly. The heat energy of the LED cooling plate is located in the exhaust air stream and can be used by the heat recovery system as an anergy source for the heat pump and directly removed during the cooling season (Figure 1).

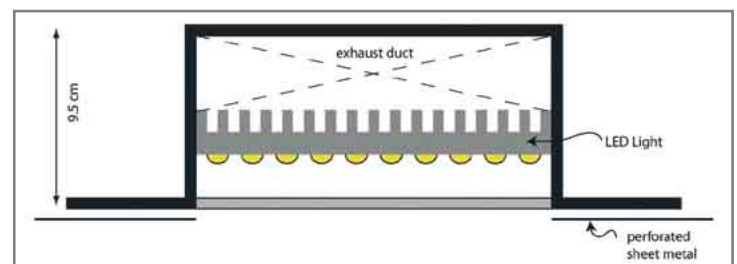

Figure 1: Section ceiling panel

Moreover an LED does not radiate in the infrared therefore no radiant heat arrives in the room again reducing the load. A third benefit of the LED technology is the reduced overall height of the light. This geometrical advantage makes it possible to develop a small overall height of the ceiling panel and therefore the architectural design of the ceiling panel can be adapted for many of the respective building tasks.

## Analysis of Propositions by LED Luminary Providers

### What We Requested

- LED fixture to stay within the limits of 400\*200\*20 mm, with a possible upgrade to 30mm thickness, with power-supply on back of luminaries using a small cross-section to allow airflow in longitudinal direction, driven by 230V.
- LED fixture to provide 1200 lm effective white light directed downwards, Color Temperature <= 4800K.



- LED fixture to ensure glare protection both with low angles (according to the established standards for office lighting) as well as limit point glare to 3000 cd/m<sup>2</sup> and ensure a max 1:8 ratio of brightness difference between point maximum and surface brightness seen under a 0.5° angle from any direction.

### What We Got Splits Up in Two Base Principles

- Solutions using few High Performance Power-LEDs with diffuser and lenses (Figure 2):

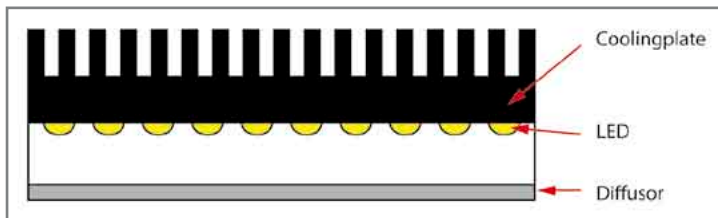

Figure 2: Section LED with diffusers and lenses

- Solutions using many low brightness surface LEDs with covering louver (Figure 3):

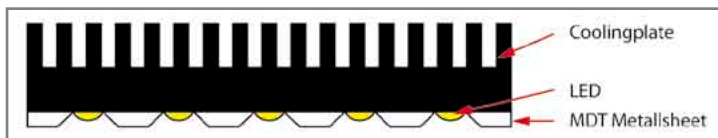

Figure 3: Section LED with covering louver

### Discussion of The Results

- Using High Power LED:
  - Measures to efficiently control glare need luminaries thickness not available.
  - Luminary appearance when lit is diffuse with non-even distribution. Some more or less brighter spots are seen and change appearance under different angles.
  - Reasonable glare control creates dramatic loss of efficiency.
- Using low-brightness surface LED:
  - Reasonable glare control.
  - Reasonable appearance, both in lit and off state.
  - Overall efficiency poor caused by poor LED lm/W.
- Adapted power supply solutions have not been provided with samples.
- With both systems color impression of LED was cold, with a blue touch when looking into luminaire, but resulted in a slightly pink impression of the light on the tables.
- The surface LED had the more interesting look and feel, it provides LED „feeling“, whereas with the diffuser lens system the lamp system is hidden and remains unclear.
- The overall heat expectations have been fulfilled: Heat radiation into room is substantially less compared to any other lighting source. The cooling of the back of the LED fixture using exhaust air is effective and adds to overall performance when rooms have to be cooled using low temperature difference sources.



Figure 4: High Performance Power-LEDs with diffusers and lenses

- Both systems ended up in very high cost and low lumen / Watt per luminary, much higher in cost and less in lm/W than expected from figures provided by LED promoters beforehand.

### Conclusion Regarding Tested System

- LED luminaries for general lighting have to deal with high point-brightness of today's power-LED.
- Today solutions for glare control reduce LED lighting to less lm/W than compact fluorescent solutions with same glare control do.
- The color appearance and performance of the tested system was below our expectations.
- LED- luminary costs remain very high.
- Medium term foreseen development with more and more light out of a single tiny point source increases the necessity to handle glare control in an effective way before LED general lighting is ready to replace other technologies.

### Overall Conclusions:

- LED lighting is one piece of a puzzle for efficient Low-Ex equipment of future buildings.
- Regarding costs and available glare control technology LED lighting is not ready to go into general purpose office and alike lighting, yet. ■

# Technology

## Photonic-Lattice Technology

> Christian Hoepfner, Luminus Devices

### Introduction

The history of LEDs shows a trend towards increasingly larger LED chips when needed and technically feasible. Until well into the late 1990s, most LEDs had chip sizes in the range from 10 to 20 mils (250 – 500 micron). LEDs were used mostly as indicator lights, and in most applications a small number of such small LEDs was sufficient to generate the amount of light needed. With the advent of high-brightness LEDs, applications which require significantly more light became feasible, driving in turn an increase in chip size to the “power” chip with typically 1 mm<sup>2</sup> size by the end of the 1990s. Those chips can today generate between 100 and 200 lumens at standard drive conditions, and have started to penetrate many lighting applications, for example in entertainment lighting and portable flashlights. However, most general illumination applications need to provide 1000s of lumens, requiring the combination of many power chips in one package, or many power packages on one board. Clearly, there is the need for LED chips which are capable of emitting 1000s of lumens. Until recently, large LED chips with more than 1 mm<sup>2</sup> were not efficient, and could not be manufactured at sufficiently low cost. This problem has been solved with the development of PhlatLight® LEDs. This article describes PhlatLight technology, how it enables large LED chips, and how large LED chips can be used to enable high performance lighting solutions.

### PhlatLight Technology

PhlatLight LEDs are based on a suite of innovations to enable high performance large LED chips. The name PhlatLight is derived from Photonic Lattice. While photonic lattice technology is the marquee technology behind PhlatLight devices, other innovations are equally important to enable high performance, large LED chips.

#### Photonic Lattice – How It Works

Since the early days of LEDs in the 1960s, a key challenge in LED design was the efficient extraction of light from inside the semiconductor chip which generates the light. The large difference in refractive index between the semiconductor chip and air does cause total internal reflection which traps the light inside the chip. Chip shaping, roughening and encapsulation are the techniques used to overcome this problem with traditional LEDs.

Now, photonic lattices are available to enhance light extraction from the chip. Photonic lattices, often also referred to as photonic crystals or photonic band-gap materials, are created by embedding periodic structures into dielectric or semiconducting materials. The lattice constants for these periodic structures are on the order of the

wavelength of light, with critical dimensions well below 100 nm. The periodic structures create an optical band gap that forbids propagation of light with certain frequencies and directions, and therefore can fundamentally change how light propagates in the host material.

A comparison with an electrical band gap may illustrate this. In a crystalline material made from a lattice of atoms, the material's electrical properties are influenced by the periodic variation of the electrical field caused by the atoms in the crystal structure. Electron diffraction effects caused by the periodic variation will form forbidden electronic states for the electrons, creating an electronic bandgap. This bandgap causes the transition of the material from a conductor to a semi-conductor, which is the basis for all microelectronic devices – and LEDs.

The patented photonic lattice design (Figure 1) in PhlatLight LEDs suppresses lateral propagation of light along the quantum wells. Light is therefore forced into states perpendicular to the surface, forcing it out of the chip through the surface. This innovative way of light extraction offers the following advantages:

- All light is emitted from the surface, photonic lattice LEDs have no edge emission. Light coming from the chip surface can be used more efficiently in optical systems, and does not require redirection with mirrors or encapsulant as is the case with light coming from the chip edge.
- Because the light is emitted close to the location where it is generated, the chances of re-absorptions are reduced, increasing the extraction efficiency of the LED.
- Traditional extraction techniques like chip shaping and encapsulation have lower efficiency for larger chips. The photonic lattice makes the extraction efficiency independent of the chip size and shape, thereby enabling large chip technology. With a photonic lattice, large LED chips can have the same extraction efficiency as small chips.
- Photonic lattice LEDs do not require an encapsulant, because the light is extracted right into air. Eliminating encapsulant offers efficiency advantages for many optical designs, and also eliminates several of the most common failure modes of LEDs, including wire-bond stress related failures and encapsulant aging.

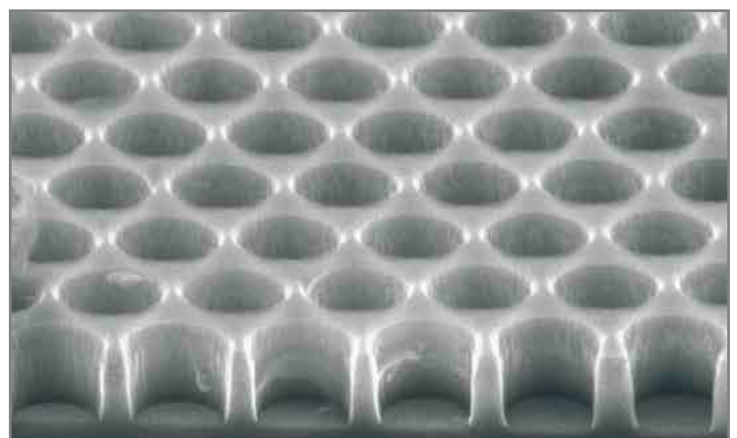

Figure 1: Micrograph illustrating a photonic lattice. The periodic variation of the refractive index due to the hole spacing controls the propagation of photons in the vicinity of the lattice. PhlatLight LEDs use a similar concept designed specifically for optimized light extraction.

Photonic lattice fabrication requires the control of very small feature sizes of less than 100 nm. This is traditionally very expensive, and not compatible with the cost targets for mass market LEDs. A major milestone for PhlatLight LEDs was the development of a high volume, low cost manufacturing process which offers remarkably high yields. In fact, the precise process control this process offers may not only match but exceed yields for traditional, surface roughened power chips, and in this way enables high volume manufacturing of large LED chips.

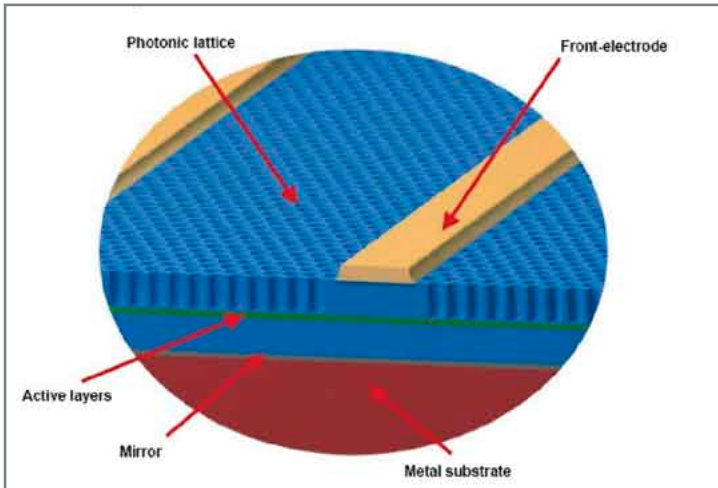

Figure 2: Cross section of PhlatLight chip. Green and blue chips are based on GaN materials, red chips on AlInGaP. While the fabrication processes for these materials are different, the general construction of the chips is the same.

### Highly Efficient Chip Thermal Design

In order to remove heat efficiently from large LED chips, excellent thermal management is required. As part of the PhlatLight suite of technologies, a vertical chip design to address both electrical and thermal challenges was developed. Most high-brightness blue and green LED material is grown on sapphire wafers. While sapphire enables the growth of high-quality contact layers and quantum wells, it is electrically isolating and has very poor thermal conductivity. By bonding the epitaxial wafer to a metal submount and then removing the sapphire substrate, the epitaxial layers with the quantum wells are transferred to a superior substrate material. The new metal submount has very low thermal resistance, and it provides a full area metal contact to the LED. This vertical design enables very low thermal resistance values ( $<0.8$  C/W), unmatched by other LEDs.

Figure 2 shows a cross section of a PhlatLight LED chip. The active layers, including quantum wells, have been bonded to the metal submount. The two-dimensional photonic-lattice structure is embedded into the surface of the LED chip.

### Easy to Use LED Package

Currently, all PhlatLight LEDs are being manufactured with a chip-on-board package, specifically designed for high power densities (Figure 3). It consists of a copper board with connector and a thermistor for thermal monitoring. The LED chip is directly bonded to the board for

lowest thermal resistance. The copper board offers high heat spreading capability, enabling the use of easy to use thermal interface materials like graphite foils between board and external heat sink.



Figure 3: Construction of PhlatLight CBT-120 package. The actual PhlatLight chip is directly bonded to a copper heat spreader, which also includes a thermistor, connector and protective window.

PhlatLight chip technology also enables very low profile surface mount packages which are currently under development.

### Wide Range of Operating Conditions

The development of PhlatLight large chip technology was driven by the need for extremely bright light sources for projection light engines. In such systems, LEDs have to be operated at high currents in order to deliver the total flux required. PhlatLight LEDs were therefore designed from the ground up to for very high current density operation. The semiconductor junctions typically used in LEDs are more than capable of being operated at very high current densities, up to hundreds of amperes as illustrated by lasers. However, many LEDs rely on current spreading from small metal contacts at the side of the LED, which can cause current crowding at these metal contacts, thereby limiting the reliable operating current of such LEDs. The vertical chip design of PhlatLight LEDs employed to address the thermal challenges of large LED chips also solves the current crowding issue, by providing a full area metal contact to the chip.

Driven by the combination of demanding projection applications and the innovative vertical chip design, PhlatLight large chip LEDs have been qualified at current densities up to  $2.5\text{A}/\text{mm}^2$ , the highest in the industry. However, PhlatLight LEDs can of course also be operated at low current densities if the benefits of higher efficiencies at such drive conditions are desired.

### Reliability

The development of large chip PhlatLight LEDs provided the opportunity to leverage the advantages of PhlatLight technology to eliminate typical LED reliability issues. The vertical chip design avoids current crowding, and provides an excellent thermal path which enables low temperature operation even at high power densities. The lack of an encapsulant

eliminates some of the related failure modes as wire-bond breakage and encapsulant aging. By today, hundreds of thousands PhlatLight LEDs have been operated in the field with extremely low failure rates. Median lifetimes have been demonstrated to be higher than 60,000 hours in properly designed systems.

### PhlatLight LEDs

Photonic lattice PhlatLight LEDs are being manufactured in different sizes. They are specified by the size of the emitting area. Current product offerings range from 4 mm<sup>2</sup> (Figure 4) to 12 mm<sup>2</sup> emitting area. The larger the chip, the more flux can be generated from a single device. The choice of chip size depends on the total flux needed, and on restrictions the optical system may impose on emitting area size. For example, if light is coupled into light guides like light fiber bundles or planar waveguides, the chip size needs to be matched to the aperture of that light guide. Making the chip larger will not result in increased brightness. Table 1 shows performance examples of typical red, green and blue PhlatLight LEDs.

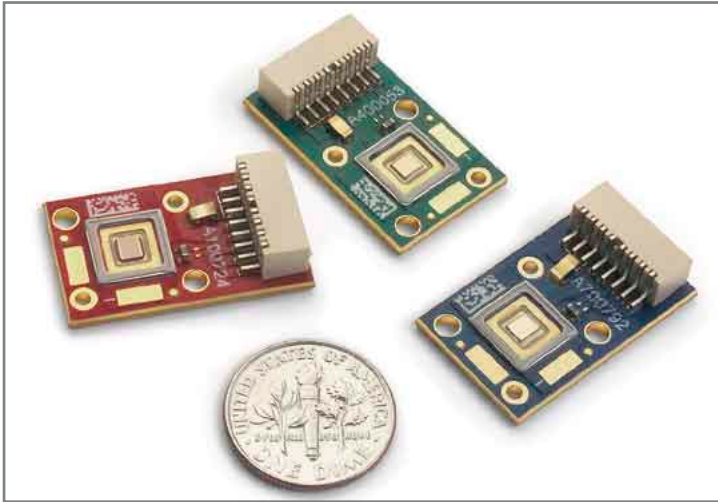

Figure 4: Red, green, and blue CBT-40 PhlatLight LED packages

## Applications of Large LED Chips

Large LED chips which deliver 1000s of lumens enable lighting designs not possible with small chips, even if those are used in large quantities. We will discuss here 2 examples, projection light engines, and multi-color spotlights.

### Projection Light Engines

Modern projection light engines use microdisplays between 0.45 inches and 0.95 inches diagonal, with projection optics f# of 2.0 to 2.8. The maximum LED size which can be used with such light engines is in the range of 8 to 24 mm<sup>2</sup>. Therefore, the available emitting area of LEDs needs to be utilized efficiently. This will favor LEDs that have surface emission only, since LEDs that exhibit edge emission require additional optics to collect this light, thus increasing the actual light-source. A good LED light source will be a surface emitter with exactly the emitting area required to illuminate the microdisplay. The aspect ratio of the emitting area will be matched to the microdisplay, corrected for any projection angles; this is typically 16:9 for HDTV. Any gaps in the emitting area caused by tiling smaller LEDs chips will cause a loss of actual brightness. Therefore, single large LED chips of the correct size and aspect ratio will be ideal. In fact, all LED projection light engines with more of 100 lm from the projection lens, regardless if for front projection or HDTV are based on PhlatLight large chip LEDs.

Projection light engines are not very efficient, due to the complex optics and losses associated with the microdisplays. For example, at PhlatLight PT120 chipset in pulsed operation can generate ~2500 average white lumens at a color temperature CCT=6500 K. About 400 lm will be available from the projection lens of a 0.65" microdisplay light engine. This enables the illumination of up to 67" projection HDTVs. Using similar large chip LEDs with more efficient optics can enable lighting fixtures with several 1000 lm output, as shown next.

PhlatLight Device	CBT-40			CBT-120			Unit
Color	RED	GREEN	BLUE	RED	GREEN	BLUE	
Typical dominant wavelength	625	525	462	625	525	462	nm
Emitting area	4 mm <sup>2</sup>			12 mm <sup>2</sup>			
<b>Continuous operation</b>							
Max continuous drive current	6	6	6	18	18	18	A
Typical voltage	2.3	.3	4.1	2.3	4.3	4.1	V
Typical luminous flux	265	625	120	875	2100	400	lm
<b>Pulsed operation (reference duty cycle 50%)</b>							
Max continuous drive current	10	10	10	30	30	30	A
Typical voltage	2.6	4.9	4.5	2.6	4.9	4.5	V
Typical luminous flux	425	925	180	1400	3100	600	lm

Table 1: Typical performance data for selected PhlatLight LEDs (at thermal equilibrium)



## Entertainment Luminaires

Entertainment lighting requires ever more luminous flux for wash and spot applications. 1000s of lumens are required from a single fixture. Using traditional power chips, this will require arrays of many LED packages who have to be spaced widely for basic beam shaping optics. The resulting fixtures are often very large, occupying valuable space and making automatic movement difficult or impossible. By utilizing a large chip PhlatLight RGB module as shown in Figure 5, more than 3000 white lm can be generated from a small area, enabling a compact optical and luminaire design. For example, with a 80% efficient optics, more than 2400 lm can be delivered from a single beam shaping optical element. Because such optics can be compact, by tiling only a few of such subsystems together, more than 10,000 delivered lm from a single luminaire can be achieved.

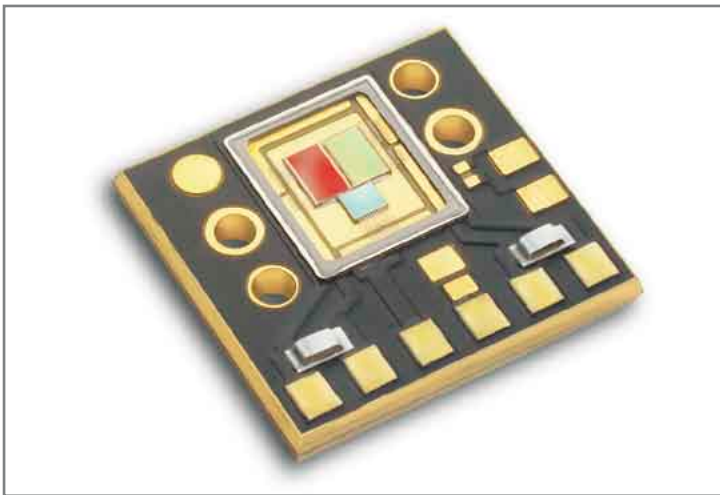

Figure 5: PhlatLight RGB module, creating highly compact, 3000 lm color tunable light source

## Cost Savings

Not every application requires the new generation of large LED chips. Many applications are served very well with traditional small chips or power chips. But the adoption of large LED chips is driven by the need for compact, high flux sources, and cost reduction for high LED count applications. Examples for compact, high flux sources have been discussed above. But even applications which are feasible with arrays of power LEDs can benefit from the large chip approach. Compact light sources enable smaller optics and smaller fixtures, which will typically translate in lower cost. The reduction in LED and other parts count does reduce system complexity, and increases reliability. This has been demonstrated with high-performance PhlatLight BLUs (backlight units) for large LCD TVs. In those systems, literally thousands of small RGB LEDs in a typical 46" BLU have been replaced with 10 large chip, high power PhlatLight LED modules. The resulting savings in LED packaging cost is several hundred dollar per TV. Even applications which need only 10s to hundreds of power LEDs can benefit from such system simplifications and cost savings.

The same cost savings can apply to the design of solid state lighting fixtures where the use of many smaller LED packages not only has high packaging cost content, but forces the addition of customized and complex optics to harvest and direct light to minimize glare and hide package-to-package color differences. Resulting small LED array fixture design platforms are both more expensive, optically less efficient and significant limit luminary design freedom.

## Conclusions

Photonic lattice technology enables the design and manufacture of large chip (larger than 1 mm<sup>2</sup>) LEDs. Such large chips are enabling compact, very high brightness light sources similar to high-intensity discharge or halogen lamps, but with the advantages of LED illumination. This does enable the replacement of such traditional light sources even in applications with very high brightness requirements. Large LED chips can also enable the reduction of part count in applications which would otherwise require many smaller LEDs, for reduced system complexity and cost. ■

The Power Behind SMART LED Lighting

**ROAL**  
living energy

ROAL's Solid State Lighting products unlock the true benefits of LED based lighting and reduce the time to market with integrated high performance electronics, short design cycles and low cost manufacturing services. High brightness LEDs convert electricity into visible light. We do the rest.

LightFair 2008 Booth# 1494  
Las Vegas, NV, May 26-30

# Evolutionary LED Packaging for Increased Flux Density

> Jason Posselt, Director of Product Marketing, LedEngin Inc.

## Introduction

With the increasing adoption of solid state lighting, applications and products are becoming more varied and differentiated. While initial products were targeted toward signaling and supplemental lighting, products are now available which displace conventional light sources and deliver truly usable light in commercial, residential and retail environments.

In addition to the environmental and economic benefits of solid state lighting, an intriguing aspect of designing with LEDs is the ability to create new and unique lighting effects difficult or impossible to achieve with conventional sources. The small unobtrusive nature of LEDs can enable new luminaire designs with miniature or hidden light sources, evoking a magical effect as light is delivered from places one would not expect.

It can be challenging for the OEM to select the right LED for the application, as not all LEDs are created equally. Critical to making an informed selection is a full understanding of the system requirements to determine how available LED options will impact the lighting effect and functionality. Some applications, such as wide area and street lighting, can afford a much larger luminaire design, enabling the designer to use multiple 1-Watt LEDs spread across a large area. This design approach may be optimized for efficacy, reducing power consumption and shortening the payback period. Spot and accent lighting applications, however, may be space limited and therefore better suited to a higher power source. In these applications the OEM may be willing to trade some level of efficacy to enable a smaller and sleeker design while still delivering increased efficacy compared to the conventional source currently employed.

As power LED chips continue to increase in performance, LED packaging must evolve to maximize performance in the application. Although the 350 mA/mm<sup>2</sup> current density or so-called 1-Watt LED product offering has seen significant innovation in packaging since its introduction, LED performance improvements will continue to support increasing current densities. Today efficacy reduces as current density increases, a phenomenon commonly referred to as droop. Semiconductor chip manufacturers are continuing to improve high current performance through ongoing efforts to reduce this effect. Future LED chips with reduced droop will further increase the demand for LED packages of 10-Watts and beyond, capitalizing on miniaturization benefits achievable with solid state lighting.

## Evolving LED Packaging Requirements

As chips capable of higher current density operation become available, innovative packaging technologies must be developed to optimize performance. LedEngin is one company leading this development effort, specializing in high power density and highly reliable LED packaging technology to enable increased performance when coupled with industry leading chip technologies.

While the LED chip may be defined as the heart of the LED package, packaging design is critical to enabling a reliable solution. The package provides the thermal, mechanical and electrical interface between the semiconductor chip and the light engine assembly, protects the chip from environmental exposure and damage, and increases the light extraction and lumen performance. Additionally, with phosphor converted white LEDs, the package may influence the method by which the phosphor is deposited onto the blue pump die to create white light.

LEDs produced by LedEngin employ innovative designs aimed at optimizing performance in these areas while eliminating package related degradation. LEDs rarely fail catastrophically, but instead gradually decay in performance over time. This non-recoverable loss of light output is referred to as the lumen maintenance of the LED. The light output degradation can come from many sources including semiconductor chip degradation, package degradation and phosphor degradation. Package related degradation is observed under highly accelerated test conditions or after sustained exposure to high temperature operation. The LedEngin package design is based on an understanding of the fundamentals of package degradation and has been optimized to eliminate these effects.



Figure 1: LedEngin high power LEDs. Row 1: 15-Watt white. Row 2 (L-R): 10-Watt RGGB, red and green. Row 3 (L-R): 10-Watt RGBA, 10-Watt warm white, 5-Watt UV and 5-Watt white

Additionally, multichip packages have been developed to further improve flux density. Products such as the 10- and 15-Watt LEDs produced by LedEngin contain four 1mm<sup>2</sup> chips in a 7.0 x 7.0 mm package footprint (Figure 1). This package footprint, comparable in size to a conventional single chip package, delivers up to 900 lumens of white light. This output, over 4X that of alternative packages, significantly increases the flux density to enable spot and accent lighting applications. With such sources it becomes possible to replace 35- to 50-Watt halogen sources with a single multichip LED, reducing the size of the solution and improving the optical efficiency of the lamp.

Multichip packaging can also deliver improved uniformity in tunable white and colored lighting applications. Individually addressable dies can be located in close proximity within a single package, reducing the challenges of color mixing for the OEM. High power multichip packages can enable the development of solid state lighting solutions which provide a homogeneous emission from the source rather than mixing on target from a pixelated source, more closely duplicating the effect of conventional lighting technologies.

## Thermal and Mechanical Design for Multi-Chip Packaging

As power densities increase, many LED manufacturers are migrating from lead frame based packaging to substrate based packaging. Many substrate options exist. The combination of both the base material selection and the composite substrate design is critical for optimal performance. For example, describing a package as ceramic does not provide enough detail to determine how it may behave thermally. The design of the substrate can easily dictate a thermal resistance which may be twice as high as another ceramic based package.

High power emitters use a base material of aluminum nitride for the ceramic substrate. This material provides a low thermal resistance due to its high thermal conductivity. It is not merely the material used which delivers the performance, but the design optimization of the embedded metal layers to further reduce the package thermal resistance while minimizing internal stresses that can be caused by mismatches in the coefficients of thermal expansion (CTE). Additionally, as the ceramic serves as the body of the package, the design must provide adequate protection for the LED chip and enable a highly efficient encapsulation system.

LedEngin uses a flux-less eutectic die attach process to provide a mechanically and thermally robust bond between the package and the chip. Die attach robustness is critical to ensuring long-term reliability, enabling higher current operation and increased flux density. The flux-less eutectic process not only provides a strong joint between chip and package, it also eliminates the use of organics in the package that can lead to contamination and degradation over time. This package design supports standard lead-free reflow assembly capable of withstanding up to 6 reflow cycles, 2X that of competitive packages. Junction to case thermal resistance values of 5.5°C/W have been achieved for single chip 5-Watt packages, and values below 2.5°C/W have been achieved for 4-chip 15-Watt products.

The 15-Watt package has been designed to further reduce the system thermal resistance. Identical in footprint size (7.0 x 7.0 mm), the substrate of the 15-Watt LED is unique in that the electrical leads exit the top of the LED package rather than on the bottom for SMT assembly. Electrical connection to the LED is made via a flex circuit mounted to the top surface of the package. This LED can be mounted directly to the heat sink, eliminating the need for the metal core printed circuit board (MCPCB) and significantly increasing the thermal headroom of the lighting system. For example, if the thermal resistance adder for the MCPCB is assumed to be 2°C/W, a 15-Watt LED directly mounted to the heat sink delivers an additional 30°C of operational capability.

## Chip Protection and Light Extraction

Once the chip is thermally and mechanically mounted in the package, the next step is to optimize light output while protecting the chip to enable reliable long-term operation. Various encapsulation methods are used in high power LED packaging. Low performance small- to mid-power LEDs typically use a cast epoxy for both the mechanical housing and optical encapsulation. This is not a suitable option for high power LEDs as this material will degrade over time when exposed to the high energy short wavelength blue photons. Even high performance plastics begin to show the effects of aging as performance levels increase, which has caused many LED manufacturers to consider either silicone or glass lenses, typically combined with an internal silicone encapsulation surrounding the die to eliminate air gaps and improve optical efficiency.

All these packages use a glass lens filled with a soft silicone gel encapsulant. The silicone provides a low stress environment around the LED chips and internal wire bonds, increasing product robustness and minimizing damage that could be caused by temperature cycling over the operating life of the LED. Material selection is driven by the index of refraction, and materials are selected to optimize both the light extraction and photon conversion for white devices. Silicones are specified which are resistant to short wavelength blue emissions, eliminating aging effects that can result in a loss of light output over time.

Two methods are primarily used to produce phosphor converted white devices: deposit a phosphor loaded slurry into a cup surrounding the chip, or deposit a thin layer of phosphor directly on the chip. The first of these methods, while used for early white LEDs, has seen lack of proliferation due to its poor color over angle performance. Today many manufacturers use chip level phosphor deposition methods. While chip level coating has advantages in terms of reducing the source size of the LED and improved color over angle uniformity, challenges can occur as the phosphor material is placed directly on the heat source of the LED package, the semiconductor chip.

LedEngin packages use a proprietary phosphor deposition method (Figure 2). After die attach and wire bond, a thermally insulating layer of silicone is deposited into the package. This insulation layer eliminates hot spots within the phosphor material that can cause discoloration or



browning, resulting in accelerated lumen degradation. The reduced temperature of the phosphor also results in improved color stability over both temperature and time, critical to delivering the color consistency required in the application. The phosphor is deposited using unique process technology, resulting in a consistent layer thickness to improve color over angle uniformity. Additional layers of silicone are then deposited above the phosphor to complete the interior encapsulation and assist in bonding the outer lens.

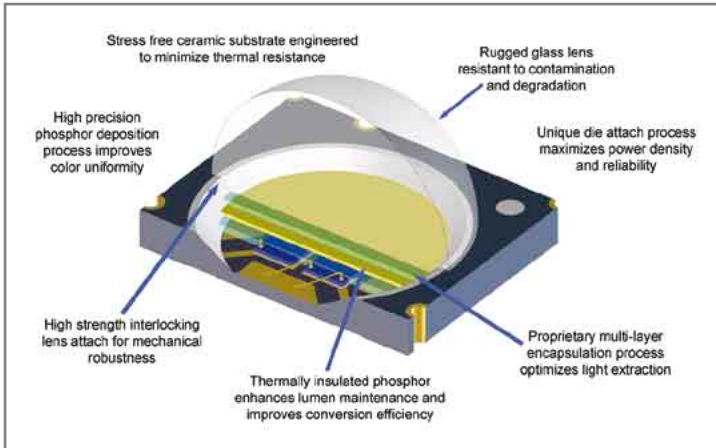

Figure 2: Cutaway view of LedEngin 10-Watt LED

Glass is an extremely robust and reliable material which has excellent optical properties, does not suffer easily from optical degradation or mechanical impact, and is impervious to moisture. The design of the lens is such that the combination of a tight mechanical fit and adhesive bond to the top silicone layer provides a robust environment surrounding the die, and is capable of withstanding standard pick and place assembly methods without damage. The encapsulation and lens design eliminate bubbles, crazing, chip delamination and browning which can all result in increased lumen degradation.

Although not hermetic, the LedEngin product is extremely resistant to moisture and other contaminants which may damage the semiconductor chip and affect long-term reliability. All products are autoclave compliant per JEDEC JESD22-A102-C and have a JEDEC moisture sensitivity level of 2, enabling one year of factory floor life once removed from protective packaging and prior to reflow solder assembly.

## Eliminating Package Related Degradation

One of the most stringent LED packaging tests is the wet high temperature operating life test, or WHTOL test. Package related degradation is typically accelerated by three factors: heat, humidity, and high intensity short wavelength blue photons. Standard automotive and military grade WHTOL testing requires units to be operated in an 85°C/85% RH environment for 1000 hours. Product is considered to pass this test if the average light loss is less than 30% and the maximum light loss (from a single unit in the sample size) is less than 50%. LEDs which pass these criteria may still be rated with average lumen maintenance of 70% at 50K hours due to the accelerated nature of this

test condition. As not all LED packages are capable of passing this test, some manufacturers have begun qualifying to a relaxed condition of 85°C/60% RH. Typical qualification points are between 500 and 1000 hours with the same pass-fail criteria described above.

LedEngin has conducted 4000 hours of WHTOL testing on its 5-Watt LED. The first 2000 hours of this test were run at the relaxed 85°C/60% RH test condition. After observing virtually no degradation, the same units were then subjected to an additional 2000 hours of 85°C/85%RH WHTOL testing. After the 4000 hours of combined testing, the average degradation was 15% (Figure 3) and no shift in correlated color temperature (CCT) was observed.

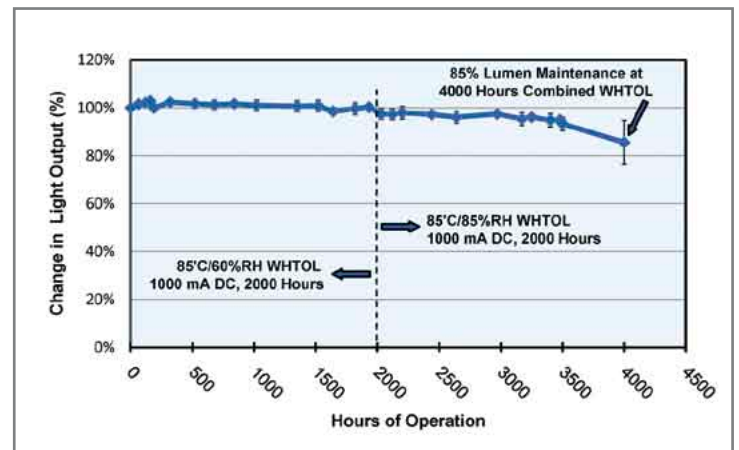

Figure 3: Results after 4000 hours of WHTOL testing on LedEngin 5-Watt LEDs

Even though the WHTOL test condition is severe, these results emphasize the protection that the LedEngin package gives the semiconductor chip, eliminating package related degradation even in this extremely harsh environment. After 4000 hours of WHTOL, the LEDs appear identical to when they first emerge from the production line (Figure 4). This is not common for WHTOL testing, in which LEDs often suffer from package related degradation resulting in yellowing, browning or cracking of the encapsulation system. This is not the case in the LedEngin package, which can extend the product life in this harsh environment significantly (4-8x) compared to alternative packaging technologies.

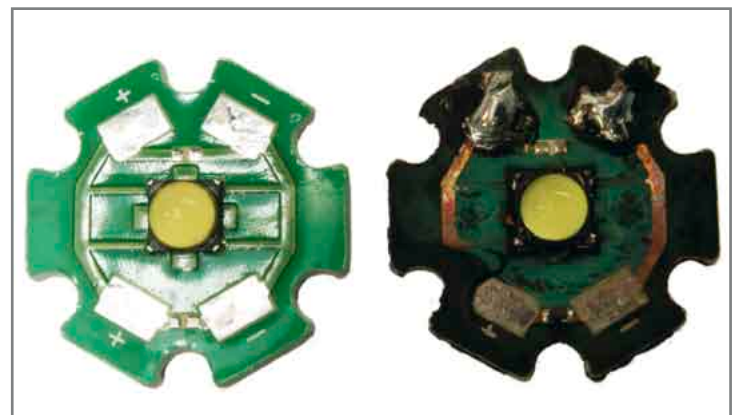



Figure 4: LedEngin 5-Watt LEDs before (left) and after (right) 4000 hours of WHTOL testing. No package related degradation observed



## Conclusions

As semiconductor performance and power density capabilities continue to increase, so will the demand for higher power density multichip packaging to enable higher lumen density solutions. These developments will support an increasing number of novel and miniaturized lighting applications, capitalizing on the benefits of compact and unobtrusive solid state lighting solutions. Critical to the package design is: to avoid limiting the capabilities of the chip, to provide a highly conductive thermal path and a protective environment, and to enhance the light extraction from the chip. While some applications may be well served by the 1- to 3-Watt products available today, there will be a growing demand for packages in the 10- to 20-Watt range and beyond. ■



**POWER VECTOR IS: ENGINEERED LED POWER**

Our Team of engineers, designers, and software specialists has a history of delivering innovative and effective power solutions. Power Vector's 3-IN-1 **IRIS LED Driver Dimmer™** combines Power Isolation, DMX512A Interface, and up to 8 Configurable Channels for driving and dimming ANY high brightness LEDs.

- 86 Watts
- Ideal for any High Brightness LEDs from 350mA up to 1.5A
- Class 2 Outputs
- USITT DMX512A Compatible
- Power Vector's Unique Dimming Method, used in all our products

Coming soon, Power Vector's **TRINITY LED Driver Dimmer™**.

**3 IN 1 LED DRIVER DIMMERS**

Power Isolation

DMX interface

Current Drivers



**PUZZLE SOLVED**

Have a look at our website [www.powervector.com](http://www.powervector.com).  
For more information call 1-888-LED-3IN1(533-3461)  
or email to [info@powervector.com](mailto:info@powervector.com).

## LED Test and Measurement



Measure all optical and electrical parameters of single LEDs, high-power LEDs and LED modules in conformity to international standards accurately and within seconds. With equipment from INSTRUMENT SYSTEMS – the world leader in LED metrology.

- Luminous intensity (candela)
- Luminous flux (lumen)
- Dominant wavelength (nm)
- Color coordinates (x, y, z)
- Spatial radiation pattern
- Thermal behavior



phone +49 89 45 49 43-0  
[info@instrumentsystems.de](mailto:info@instrumentsystems.de)  
[www.instrumentsystems.de](http://www.instrumentsystems.de)

WE BRING QUALITY TO LIGHT

# Driver

## Parallel LED Luminous Flux Variation

> Ed Wenzel, STMicroelectronics

### Introduction

There are many LED lighting applications for individual LEDs as well as multiple LEDs. The multiple LEDs can be placed in series, in a single string, or in two or more parallel strings. With multiple parallel strings, some current balancing techniques may be required to allow for LED parameter variations. Without reasonable current variation, current through one string can be excessive and cause uneven lighting or damage to the LEDs. Driven by cost, a single current sense circuit without a current balancing circuit or an LED driver is preferred for multiple LED strings.

There is an application note, from an LED manufacturer, for current variation in parallel LEDs using an iterative approach. Another article states "Do not put LEDs in parallel with each other." LEDs can be selected for use in parallel by binning and some LED manufacturers are designing multiple LEDs in parallel on the same substrate. For parallel LED applications, a more analytical approach is useful to determine the current and luminous flux variation

### Theoretical Background and Equations

For a single LED, the LED forward current only depends on the tolerance of the current sense circuit.

When two LEDs are connected in parallel, with only one sense circuit, the forward voltage across the LEDs will be equal and the current variation depends on the LED forward voltage and current characteristics.

One LED, based on a nominal forward voltage and current, is compared to another parallel LED, which has a higher forward voltage and a lower LED forward current.

From two data points, in the linear area of the LED specification, an equation for a straight line can be derived. Another equation, with the same slope, can represent an LED with a higher forward drop in order to analyze the LED forward current variation.

The following four parameters are necessary to determine this problem:

- I<sub>LED</sub>: LED forward current
- V<sub>LED</sub>: LED forward voltage
- m: slope
- b: y-intercept

### Calculation of dependencies between I<sub>LED1</sub> and I<sub>LED2</sub>

From the linear equation:	$y = mx + b$	1
$I_{LED} = m V_{LED} + b$		2
$b = I_{LED} - m V_{LED}$	solve 2 for b	3
$I_{LED1} = m1 V_{LED1} + b1$	for LED1	4
$I_{LED2} = m2 V_{LED2} + b2$	for LED2	5
$I_{LED1} - I_{LED2} = m1 V_{LED1} + b1 - m2 V_{LED2} - b2$	4 - 5	6
$V_{LED2} = V_{LED1}$	for equal forward voltage	7
$m2 = m1 = m$	for equal slope	8
$I_{LED1} - I_{LED2} = m1 V_{LED1} + b1 - m1 V_{LED1} - b2$	7, 8 in 6	9
$I_{LED1} - I_{LED2} = b1 - b2$		10
$I_{LED2} = I_{LED1} + b2 - b1$	solve 10 for I <sub>LED2</sub>	11

### Calculations with Data Sheet Values

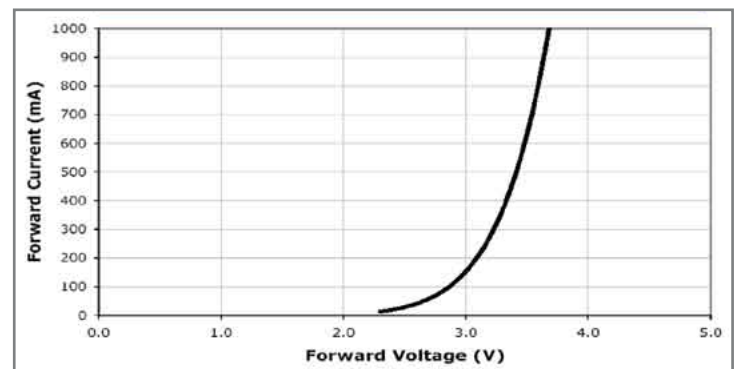

Figure 1: LED Forward Current vs. Forward Voltage Curve

Characteristics	Unit	Typical
Forward Voltage (@350mA)	V	3.3
Forward Voltage (@700mA)	V	3.5
Forward Voltage (@1000mA)	V	3.7

Table 1: Electrical Characteristics From Data Sheet

The LED forward current vs. forward voltage curve is in Figure 1. The electrical characteristics from the data sheet, in Table 1, are points on the curve in Figure 1.

From Table 1:  
 $V_{LED2} = 3.7$ , I<sub>LED2</sub> = 1.0  
 $V_{LED1} = 3.5$ , I<sub>LED1</sub> = 0.7

### Calculate slope, m, from LED data sheet

$m = (y2 - y1) / (x2 - x1)$  for slope m  
 $m = (I_{LED2} - I_{LED1}) / (V_{LED2} - V_{LED1})$  for LED m  
 $m = (1.0 - 0.7) / (3.7 - 3.5) = 1.5$   
 $b2 = I_{LED2} - m V_{LED2}$  from equation 3  
 $b2 = 1.0 - 1.5 \times 3.7 = -4.55$   
 $I_{LED2} = m V_{LED2} + b2$  from equation 5  
 $I_{LED2} = 1.5 V_{LED2} - 4.55$  Figure 2 green solid plot  
 $I_{LED2} = 1.0$  Figure 2 blue dash plot  
 $I_{LED1} = 0.7$  Figure 2 black dash plot

For an LED voltage at 1A, 5% higher than the nominal 3.7V

$$\begin{aligned} VLED5\% &= VLED2 \times 1.05 \\ VLED5\% &= 3.7 \times 1.05 = 3.885 \\ VLED5\% &= 3.885, ILED5\% = 1.0 \\ b5\% &= ILED5\% - m \cdot VLED5\% \\ b5\% &= 1.0 - 1.5 \times 3.885 = -4.827 \\ ILED5\% &= m \cdot VLED5\% + b5\% \\ ILED5\% &= 1.5 \cdot VLED5\% - 4.827 \end{aligned}$$

Figure 2 red solid plot  
from equation 11

Figure 2 red dash plot

The per cent change in LED current

$$\begin{aligned} ILEDchg &= -100 (ILED2 - ILED5\%) / ILED2 \\ ILEDchg &= -100 (1.0 - 0.723) / 1.0 = 27.75\% \end{aligned}$$

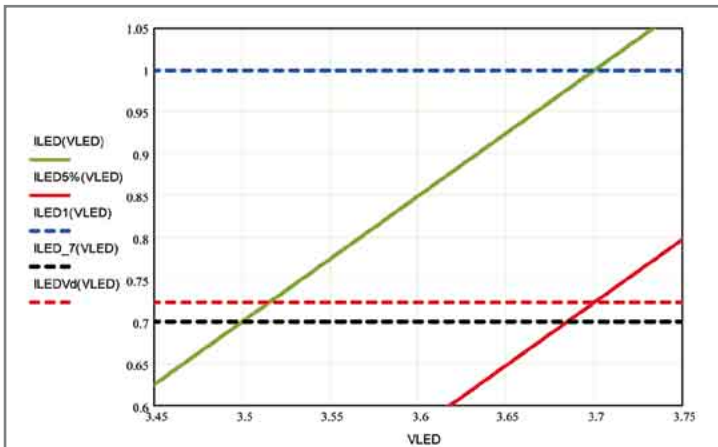

Figure 2: LED Forward Current vs. Forward Voltage From Equations

Calculation of relative luminous flux from equations

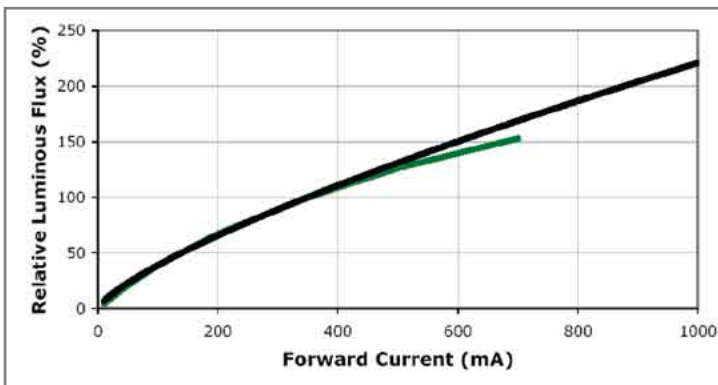

Figure 3: Relative Flux vs. Current @ Tj = 25°C from the data sheet

The LED Relative Luminous Flux vs. Forward LED Current (ILED) curve (black plot) is in Figure 3.

RLF: Relative Luminous Flux (decimal)  
ILED: LED forward current (A)

The following are points from the curve.

$$\begin{aligned} ILED.6 &= 0.6, RLF.6 = 1.5; \quad ILED1 = 1.0, RLF1 = 2.2 \quad \text{from Figure 3} \\ RLF.6 &= 1.5 \quad \text{Figure 4 black dash plot} \\ RLF1 &= 2.2 \quad \text{Figure 4 blue dash plot} \\ m &= (RLF1 - RLF.6) / (ILED1 - ILED.6) \\ m &= (2.2 - 1.5) / (1.0 - 0.6) = 1.75 \\ b &= RLF1 - m \cdot ILED1 \\ b &= 2.2 - 1.75 \times 1.0 = 0.45 \\ RLF &= m \cdot ILED + b \\ RLF &= 1.75 \cdot ILED + 0.45 \quad \text{Figure 4 red solid plot} \\ ILED5\% &= 0.723 \quad \text{current from VLED 5\% high} \\ RLF &= 1.75 \times 0.723 + 0.45 = 1.714 \\ RLF &= 1.714 \quad \text{RLF for ILED5\%, Figure 4 red dash plot} \end{aligned}$$

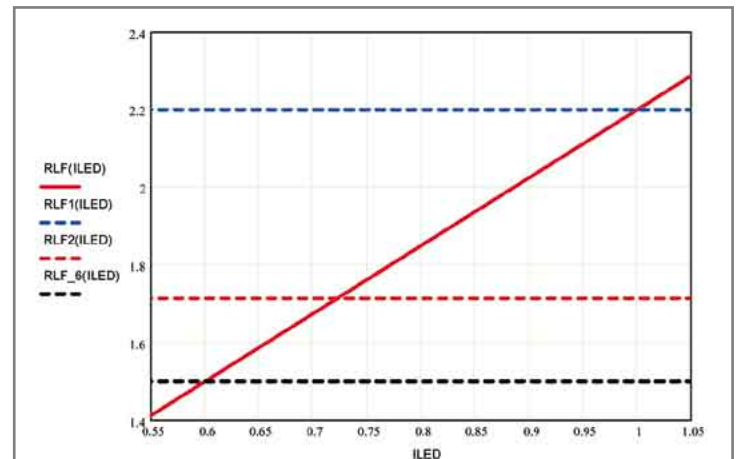

Figure 4: Relative luminous flux vs. forward current from equations

The per cent change in luminous flux

$$\begin{aligned} ILED5\% &= 0.723, RLF5\% = 1.714; \quad ILED1 = 1.0, RLF1 = 2.2 \\ RLFchg &= -100 (RLF1 - RLF5\%) \\ RLFchg &= -100 (2.2 - 1.714) = -27.75\% \end{aligned}$$

### Conclusion

A linear equation can be derived with two points from an LED data sheet. A second linear equation can be derived, with the same slope for a parallel LED, which represents the first equation with a voltage tolerance added to the forward LED voltage.

The current variation between the two LEDs in parallel is the difference in the y-intercepts of the two equations.

The two LED currents can then be plotted on a Relative Luminous Flux vs. current graph to determine the Luminous Flux variation.

A VLED voltage variation of 5% can result in an ILED forward current change of about 28% and a relative luminous flux variation of almost 50%. This does not include variation in the luminous flux variation curve. ■

# Low Noise in LED Driver Circuits

> Roger Alm, Product Marketing Manager, Melexis

The LED driver circuit described in this article uses PWM modulation to generate different levels of light output. It is also possible to implement the different levels of brake and tail light by control of the current level. In this respect, there is no difference between a linear drop regulator and a switch regulator.

From the electrical point of view, control of the current level passing through the LED is preferable. This can be done simply, in both the linear drop regulator case and the switch regulator case, by varying the value of the sense resistor or varying the reference voltage in a suitable way. With the MLX10803 LED Driver IC, this is simply done by changing the value of the resistor connected to the dominating reference input, mostly IREF1. (See MLX10803 IC specification)

From the LED manufacturers point of view a PWM modulation drive scheme is preferable. The production process results in LEDs with very different properties of light efficiency. The light efficiency can also vary using different LED currents in different ways. To have control over quality and light output the LEDs are sorted at a given LED current, usually close to the maximum rated current. Despite this sorting, the problem of inconsistent light output reappears when applying lower current level to the sorted LEDs. In addition, the color of the LED can shift slightly with different current and light output. These facts favor a PWM modulation to vary the LED intensity.

A LED in a PWM system is biased to the same current level independent of the resulting light level for the human eye. For a tail light, as in the application example, 10% of the time the current level is on and for stop light 100%, resulting in 10% and 100% light output.

Be aware! In a PWM system, there can still be an uncontrolled difference in light if the thermal management is weak. Weak thermal management can create two different temperature levels for tail and brake light levels resulting in two different light efficiencies. That could result in different light outputs than intended by the designer. A temperature compensated LED driver can solve the problem but then we are back to analog control of the LED current or a complicated feedback control of the PWM generator must be used.

This issue with different intensity at different currents and temperatures is a known design challenge. LED manufactures are working to improve their product, and LumiLEDs is now offering LEDs for automotive tail light applications tested at two different current levels. These LEDs are better suited for current level control of brake and tail functions than less carefully tested and sorted LEDs.

As a demonstrator circuit, we chose to apply the electrically more complicated PWM modulation. PWM is more difficult from an electrical noise point of view and more of a design challenge.

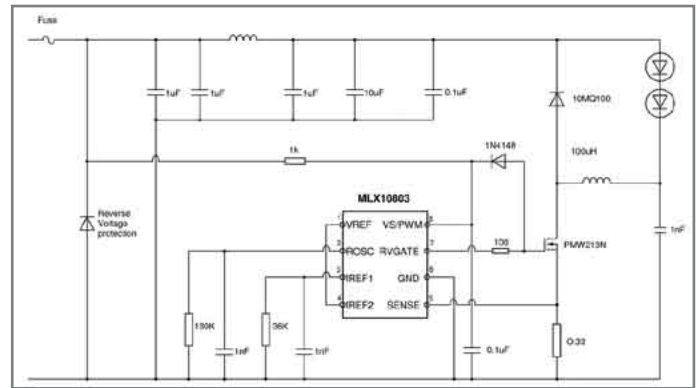

Schematic 1 This is the basic circuit used in the application

## PWM Modulation Creates Noise

PWM modulation creates the same type of electrical noise as if you used a linear drop regulator or switch regulator: the electrical noise of the low to high and high to low transitions. If you apply a switch regulator as an LED driver, you probably already have a filter function for the transition noise. Then you are in a better position with a switch regulator. Note that when using PWM on a linear regulator you might need to apply a noise filter function there as well, and you lose the simplicity of the linear regulator.

One disturbing factor is that the PWM frequency most often selected needs to be in the audible frequency range, creating a huge possibility for audible noise. Resonance in the mechanical build up can be very disturbing. This can actually happen even sooner with a linear regulator because its higher inefficiency implies the use of a larger current and results in switching higher energies than when using a switch regulator.

## Noise Standards

### CISPR 25

In the automotive electrical environment there are several tests and test setups to rate the relative noise performance of electronic modules. The most commonly used standard is defined by the IEC (International Electrotechnical Committee). The test and test set up is defined under the IEC sub committee, CISPR (an acronym from the French name for the committee known in English as the International Special Committee on Radio Interference). CISPR 25 gives five different reference levels against which to compare your application. Level 1 allows most noise and level 5 allows almost no noise. The MLX10803 LED driver IC meets CISPR 25 level 5.

### IEC 61967

IEC 61967 provides a test procedure, which defines a method for evaluating the near electric, magnetic or electromagnetic field components at or near the surface of an integrated circuit (IC). This diagnostic procedure is intended for IC architectural analysis such as floor planning and power distribution optimization. This test procedure is applicable to measurements from an IC mounted on any circuit board that is accessible to the scanning probe.



## Application Example Tail/Turn/Brake Lamp

The Lamp is designed to apply to the American standard for automotive tail lamps, including the function of tail, turn and brake light in one red lamp. The LED used is a single red high intensity LED from LumiLEDs.

The circuit can regulate the voltage down from 6 – 30V supply and supplies the LED with a 1000mA current. The Brake function is the full 1000mA over the LED. The Tail light function is a Pulse Width Modulation on this LED current in the ratio ranges 1:10 – 1:20. A LMC555 circuit creates this PWM function. An additional LMC555 creates in a similar way, but much slower, the Turn signal.

The part of the design that contains the two LMC555 has no influence on the LED driver itself and can be omitted if these functions are not needed.

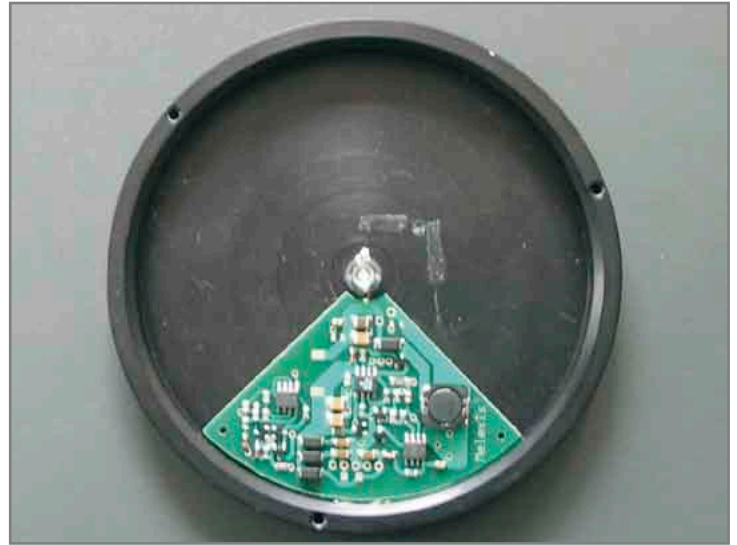
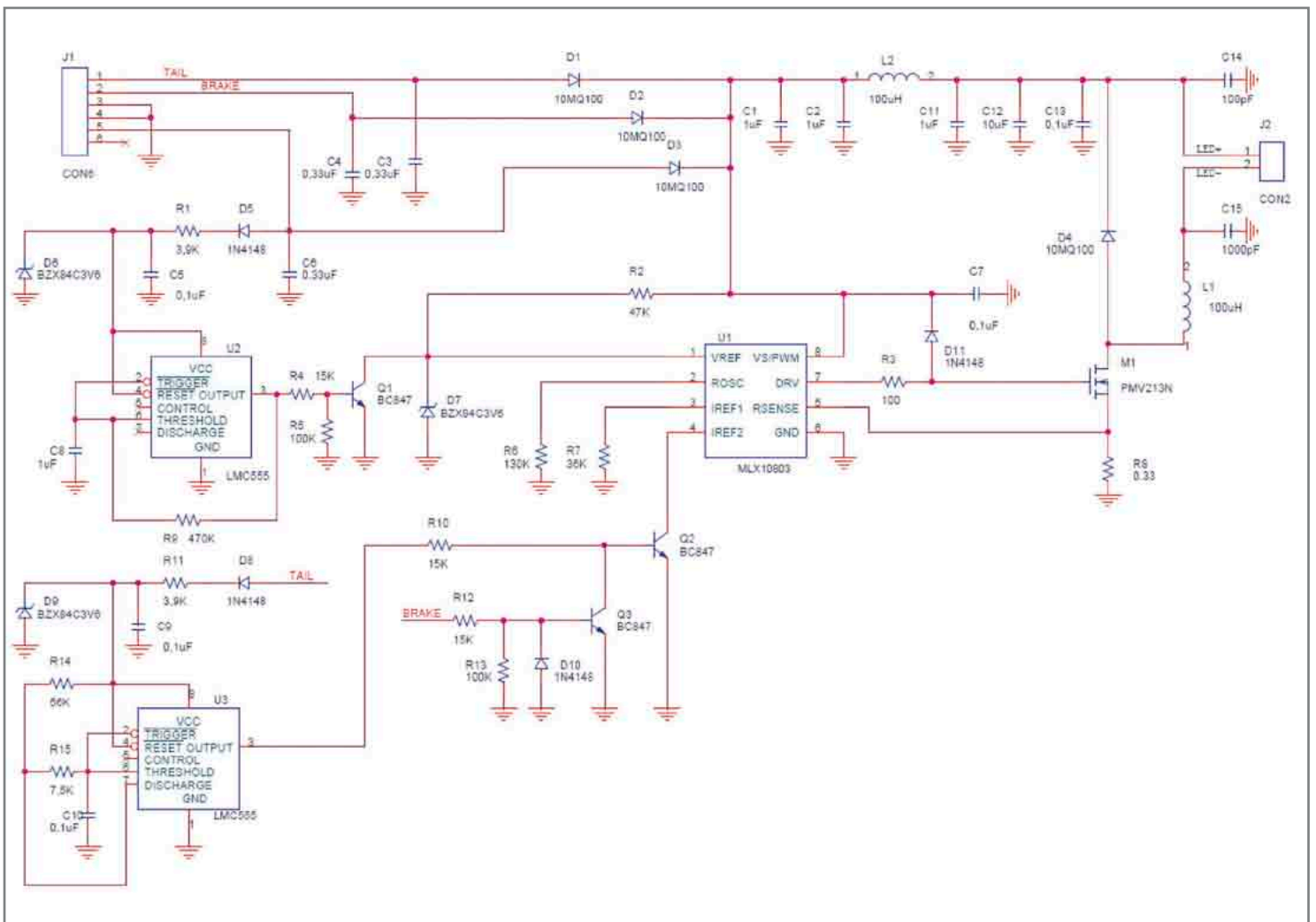

Figure 1: Tail/Turn/Brake Lamp circuit



Schematic 2 The Tail/Turn/Brake lamp circuit

## PWM and Flicker

When using a PWM controlled LED light source for ambient light, like in interior light applications, you detect a stroboscopic effect. This may be detectable under certain conditions and by certain individuals. When viewing and recording a scene illuminated by such PWM driven LEDs the camera or video recorder may show stripes. In fact it is the pulsation of the light source that illuminates the scene. Many cameras and recorders have correction settings to minimize or eliminate this effect.

Melexis does not recommend the use of PWM to modulate the light levels if instead the LEDs are available specifically sorted and characterized at different current levels. The Melexis MLX10803 LED driver is well suited for analog level control as well as PWM.

There is a slight potential health risk of a fast flickering light.. Individuals with epilepsy or other similar conditions could be subject to seizures triggered by the flickering light. The flicker effect is not unlike that experienced currently with fluorescent lighting fixtures. This effect from PWM controlled tail light products already exists on cars today using resistor or linear drop voltage regulators as LED current regulators.

## Short Note About Acoustic Noise

There are two forms of noise applicable to switch regulators: acoustical and electrical.

Linear regulators can also produce noise when we apply a PWM signal. The electrical or magnetic field applies mechanical force on the transformer and inductor components resulting in audible noise. The electrical field in capacitances and even between components can generate audible noise. The magnetic field in switch regulators stores most of the energy. This field can make coil windings, core and other parts of the coil vibrate. This type of noise can also appear by applying a PWM function on the LED driver and affects linear regulators as well as switch regulators. Mechanical noise is not good for the lifetime of any application, especially resonance, and should be avoided. How to treat acoustical noise mechanically is out of the scope of this article.

Electrical treatment of audible noise can be useful; Melexis LED drivers use a unique switching technique that allows a randomization of the switching frequency. This prevents some resonance and can because of that also result in a lower acoustic noise. ■

Photograph by Michael Betts

The logo for EuroLED 2008 features the word "eurolED" in a blue, lowercase sans-serif font. Below it, the year "2008" is displayed in a stylized, multi-colored font where each digit is a different color (2: blue, 0: green, 0: red, 8: yellow).

## Europe's Leading Conference & Exhibition for Solid State Lighting

4th & 5th June 2008

Ricoh Arena, West Midlands, UK

To register and for more information please contact Eve on +44 (0)121 250 3515  
or email [evg@astonsciencepark.co.uk](mailto:evg@astonsciencepark.co.uk)

[www.euroled.org](http://www.euroled.org)



# Designing with High Efficient LED Driver for LED Lighting

> Chih-Yu Wu, Application Engineering Deputy Mgr., Macroblock

## Introduction

The lighting industry is facing an evolution, while the development of high power LED is getting mature. Therefore, the life time of LEDs and power efficiency become important issues for LED lighting. LEDs require constant current to maintain constant color performance. Therefore, a constant current LED driver helps extend the life time of LEDs. In addition, the hysteretic PFM scheme maximizes power efficiency across a wide range of loading conditions, which satisfy the need for power saving in LED lighting applications. Finding these advantages, Macroblock develops the MBI6650, a high efficiency, constant current, step-down DC/DC converter, for high power LED lighting applications. Integrating the hysteretic PFM scheme and applying constant current, the MBI6650 enhances power efficiency up to 93% and easily extends the life time of LEDs. Moreover, safety issue is also a concern when designing a reliable lighting system. The MBI6650 also has built-in protection functions to protect the LED drivers and maintain the system reliability. The following paragraphs will further explain how MBI6650 can help on the LED lighting system designs.

## Traditional LED Driver – Constant Voltage Type

For LED applications, a forward current determines the brightness of LEDs either by a constant voltage source or by a constant current source. The larger forward current results in the brighter LED.

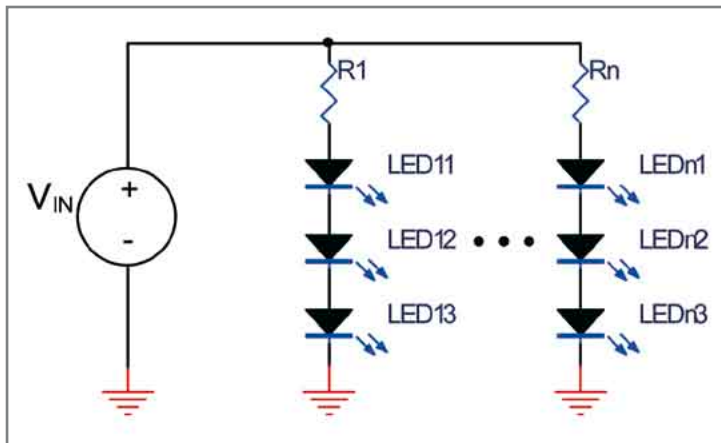

Figure 1: LED lighting with constant voltage source

Figure 1 shows the simplest design of the LED lighting with a constant voltage source in order to control the LED current by adding a current limiting resistor. For example, if the input voltage is 5V, the forward voltage of LED is 3.6V, the desired LED current is 20mA, and then the calculated R1 is 70Ω. However, the LED current varies by the degrees of the variation of the input voltage or of the LED forward voltage, which

results in the noticeably different LED brightness levels. In addition, the power dissipated in the current limiting resistor causes the heat and efficiency problems.

## Traditional LED Driver – Constant Current Type

Another LED lighting solution is designed with a constant current source. Figure 2 shows the design with the constant current source. In Figure 2, a linear regulator provides constant current to LEDs, and the output current can be programmed by R1. Compared with a constant voltage LED driver, a constant current LED driver is able to control the LED current regardless of the variations of the input voltage and the LED forward voltage. However, the increasing voltage difference between the input voltage and the total LED forward voltage will still result in heat and efficiency problems on the driver.

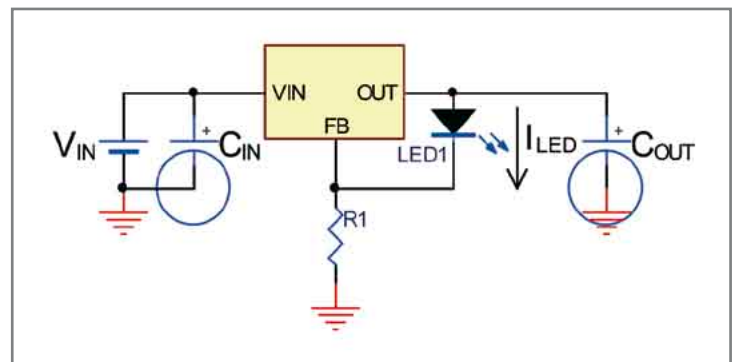

Figure 2: LED lighting with constant current source

## Hysteretic PFM Control Scheme

Hysteretic pulse-frequency-modulation (PFM) control scheme features the efficiency improvement especially at the light loading condition. Macroblock take advantages of such technology on the constant current DC/DC converter-MBI6650 for LED lighting applications. Figure 3 demonstrates the application circuit of the MBI6650 and figure 4 shows the waveform of the hysteretic PFM control scheme. In figure 3, VSEN is the voltage across RSEN, which can determine the output current; VH is the high level reference voltage, whose value is 1.3 times of VSEN, and VL is the low level reference voltage, whose value is 0.7 times of VSEN. When the power is turned on, VSEN is lower than VH, which causes the internal MOSFET of the MBI6650 to be turned on and VSEN increases with IL. Until VSEN is equal to VH, the MOSFET will be turned off, and VSEN will decrease with IL. When VSEN decreases and is down to VL, the internal MOSFET will be turned on again, and repeat the actions above. However, the inductor current will always work in the Continuous Current Mode (CCM) due to the characteristics of the Hysteretic PFM control scheme. This is helpful in terms of reducing the LED ripple current.

The switching frequency of this control scheme varies according to the output loading; that is, the heavy loading results in the low switching frequency. Under the same loading condition, the larger inductance results in the lower switching frequency. However, the lowest switching frequency is limited to 40 kHz so to avoid audio noise.



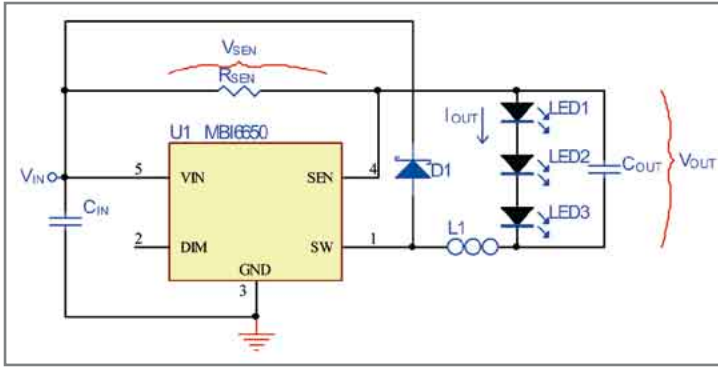

Figure 3: Application circuit of the MBI6650

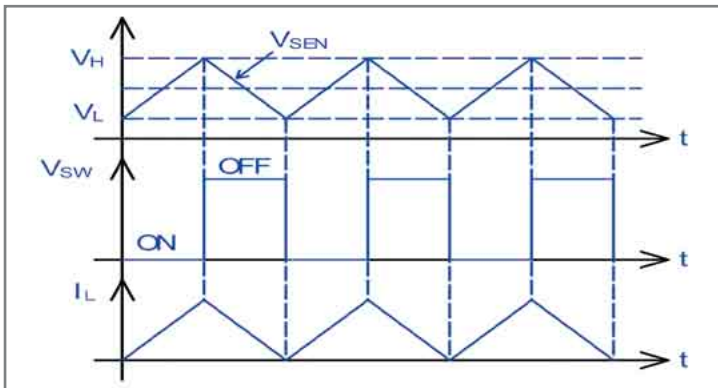

Figure 4: Waveform of hysteretic PFM control scheme

In addition to the efficiency improvement at the light loading condition, hysteretic PFM also brings other advantages such as space-saving and cost effectiveness because its high-side current limit allows users to choose a smaller size resistor with lower power consumption.

## Add-In Full Protection Functions for LED Lighting System

To ensure the reliability and safety of the drivers and the LED lighting system, the MBI6650 is also designed with full protection functions. The under voltage lockout (UVLO) function is to protect the drivers from abnormal operation with a hysteresis between the start-up voltage and the turn-off voltage thresholds of the drivers. The open-circuit and short-circuit protection functions also prevent the drivers and the system from damages. Moreover, to prevent the drivers from overheating, the MBI6650 also offers thermal protection function with the temperature limit of 140°C to prevent the drivers from overheating.

## Conclusion

The MBI6650 brings several advantages when it comes to designing safe and efficient LED lighting system, such as the efficiency improvement from the hysteretic PFM scheme, constant current source to extend the lifetime of LEDs, and the thorough protection functions to ensure the safety of the lighting system. Compared with most traditional LED driver concepts, this approach is a more effective and economic option for LED lighting applications. ■

# Comparison Between Continuous (DC) and PWM LED Driving Modes

> Laurent Massol, LED Engineering Development; Arno Grabher-Meyer and Siegfried Luger, LED professional

## Introduction

An LED has to be supplied with a current source. It's common to drive the LED current with a PWM signal, because there are lots of standard driver components at the market, also combined with control units like microcontrollers. Furthermore, dimming seems to be easy, by changing the duty cycle values, using PWM control. This analysis shows main distinctions between the widely used PWM driving mode and the alternative continuous current DC mode.

Naturally there are many other driving schemes, which are not part of this comparison.

## Setup

3 Philips Lumiled Rebel LEDs (LXML-PWW1-0040) were tested, supplied in continuous mode (DC) and PWM mode (frequency 380Hz) at different currents (25%, 50%, 75% and 100%) of the nominal value which is 350mA.

The real power consumption of the LEDs was measured. Driver and supply losses were not taken into account.

To compare both driving modes spectral measurements, correlated colour temperature (CCT) and relative intensity flux were measured with Spectroradiometer (SPECBOS 1200), Spectrometer (HR4000) and an integrating sphere.

To stabilize the temperature a specific aluminium board was used to maintain the LED pad temperature at 25°C (junction temperature below 40°C). Between 10% and 100% of the supplied current the observed temperature gradient was less than 5°C. All measurements were taken after a thermal stabilization time (> 1min).

## Results

All results are based on the average of the 3 tested LEDs, and all measurements have been taken with an error between 1% and 3%.

### Efficacy

In general, efficacy decreases for both, PWM and DC mode, when the LED power consumption increases. For higher current levels, between 80% and 95%, PWM mode is more efficient than DC mode but below 80% analogue dimming exceeds PWM dimming in lumen output at same power levels. (Figure 1). It has to be noticed that the results may differ for very low average current levels, below 10%. At 100% duty cycle PWM and DC mode efficacy values are equal.



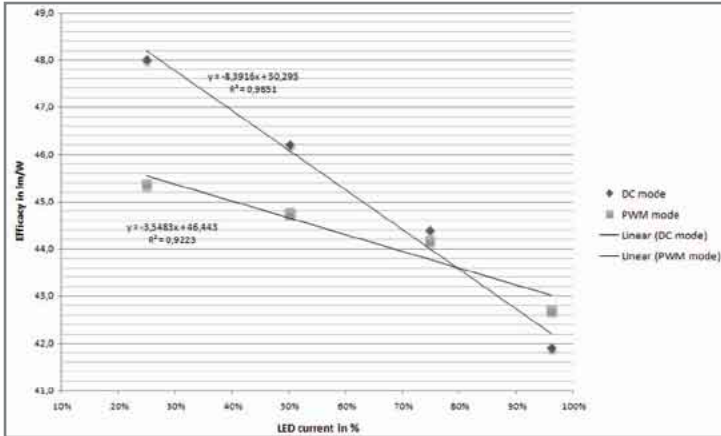

Figure 1: Efficacy as a function of LED current for PWM and DC mode

### Colour temperature

Decreasing the LED current in DC mode leads to an increase of the colour temperature from 2845°K up to 2930°K (Figure 2), ending up in a 3% CCT failure (Figure 3). In PWM mode the CCT is more accurate, showing a maximal CCT deviation of 1.5%. The spectrum power distribution graphs (Figures 4 and 5) display the wavelength shifts and power degradations at a wavelength range between 430 to 500nm.

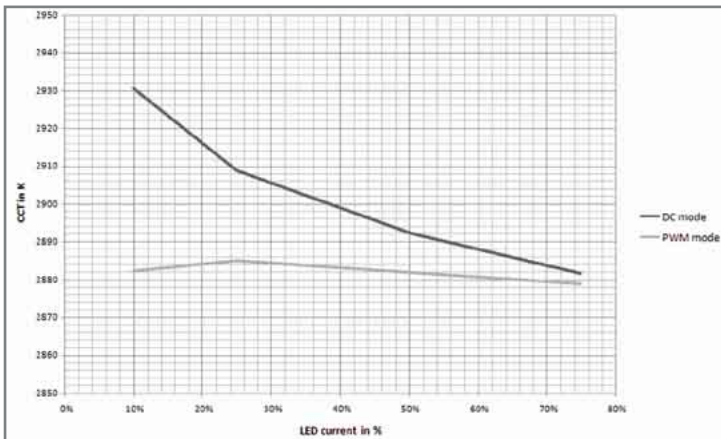

Figure 2: Correlated Color Temperature (CCT) as a function of LED current in DC and PWM mode

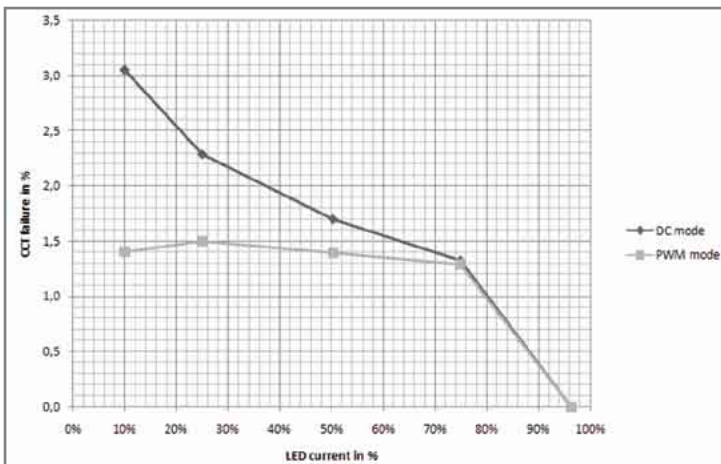

Figure 3: CCT failure in % as a function of LED current

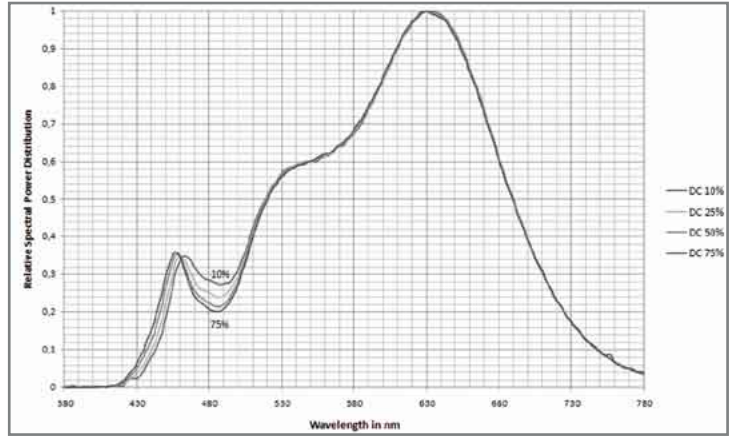

Figure 4: Relative spectral power distribution in DC mode

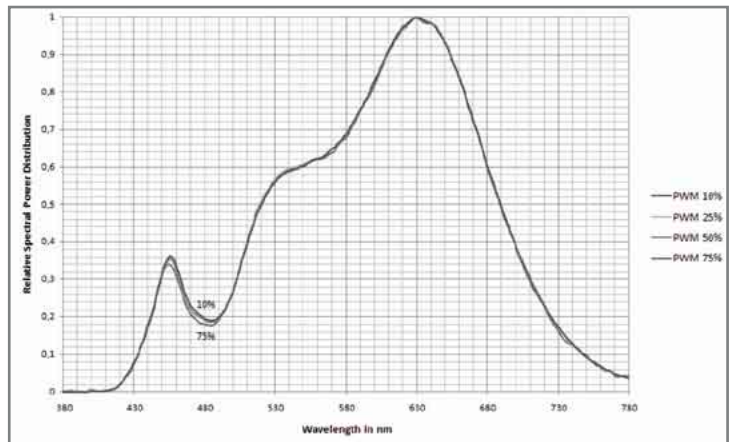

Figure 5: Relative spectral power distribution in PWM mode

### Conclusion

PWM driving mode for LEDs has clear advantages against continuous, analogue DC mode. The color temperature and color spectrum staying more stable and at high current levels the efficacy is equal or slightly better. The only drawback of PWM mode is the efficacy degradation for LED driving currents below 80% of the nominal LED current. The PWM mode suffers from an approximately 5% lower efficacy value compared to DC mode. This topic might be an interesting field for research on innovative, alternative driving concepts to overcome this weakness.

The selection of the appropriate driving mode does not depend on efficacy only, but also on system efficiency. This includes electrical losses of driver and supply electronics.

Further analysis should be performed in the range below 10% LED driving currents. ■

# Thermal Management

## An In-Depth Look at Active Cooling Thermal Management: Synthetic Jet Technology

> Mick Wilcox, Nuventix

### Introduction

Innovation in lighting design is being greatly impacted by innovation in thermal management. Prior to the use of synthetic jet technology, product designers were limited in the size and lifespan of their LED designs due to the heat constraints unaddressed by traditional thermal management solutions (fans). Today, patented SynJet™ technology provides high reliability, low audible noise, flexible form factors and low power consumption cooling – all attributes which greatly benefit the LED product designer.

The LED market, stand-alone lighting as well as for use in LCDs, is proliferating at the rate of 15-20% per year and is expected to reach \$7 billion in just three years. This growth will be attained through new uses of LEDs, many of which will require active cooling. Synthetic jet technology is ideal for active LED cooling because of its high reliability, low power consumption, quiet operation and almost undetectable airflow. It allows two to three times the light output compared to passive LED thermal management designs.

Proper thermal design is critical for LED products to achieve high lumen output and long life. Without effective thermal management and heat sinking, the junction temperature of an LED rises, causing it to lose efficiency and create diminished light output. Thermal stress can also lead to failure of the LED wire bond, delamination, detached internal solder joints, and die-bond epoxy damage. For every 17°C above 90°C an LED's life expectancy is cut in half. An active cooling solution is often necessary for applications that use many tightly packed LEDs, have a small volume or surface area where natural convection is inadequate, or that are located where the ambient temperature is high. Active cooling allows the lumen output of individual LEDs to increase without the repercussion of thermal damage or lower life expectancies.

Several characteristics of synthetic jet active cooling technology which will enable widespread adoption of LEDs in high-lumen applications include:

- **Increased thermal efficiency:** SynJet technology makes it possible to remove more heat with less air and does not require additional air to be plumbed in as with conventional jets. Synthetic jet systems are 50% more thermally efficient in removing heat from the source compared to laminar flow normally associated with active cooling air flow.
- **Form factor:** SynJets have the unique ability to bend air flow in ways that are nearly impossible with traditional air movers allowing for unique designs for luminaires.
- **High reliability:** Conventional air movers, like fans and blowers, are the lowest reliable component in the system; this is not the case with SynJet modules, which provide 10x the reliability of fans.
- **Low audible noise:** With frictionless parts, SynJet modules may be designed for effectively silent operation.
- **Low power consumption:** SynJet modules can cool the same thermal load as a conventional fan with a fraction of the power needed.

Some applications may also require resistance to dust and particle contamination or unusual geometries to accommodate innovative aesthetics. SynJet cooling solves all of these problems.

### Synthetic Jets Defined

Synthetic jets (Synjets™) are formed by periodic suction and ejection of fluid out of an orifice bounding a cavity by the time periodic motion of a diaphragm that is built into one of the walls of the cavity (Figure 1). During the ejection phase (), a coherent vortex, accompanied by a jet, is created and convected downstream from the jet exit. Once the vortex flow has propagated well downstream, ambient fluid from the vicinity of the orifice is entrained.

Nearly all of the high speed air has moved away from the orifice, avoiding being pulled back into the SynJet cavity, while quiescent air from around the orifice is sucked into the orifice. Thus, a synthetic jet is a "zero-mass-flux" jet comprised entirely of the ambient fluid and can be conveniently integrated with the surfaces that require cooling without the need for complex plumbing. The far field characteristics (e.g. rate of lateral spreading and streamwise decay of centerline velocity) are similar to conventional turbulent jets.

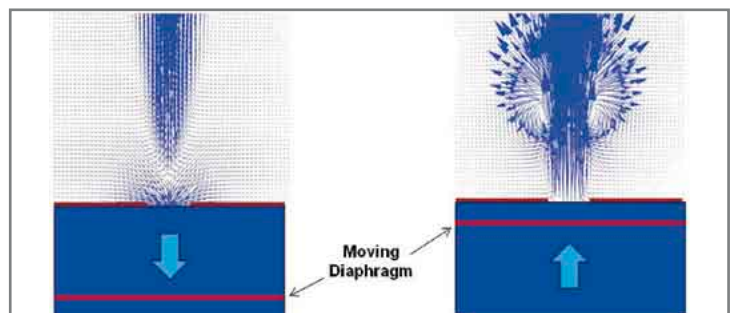

Figure 1: Particle Image Velocimetry data of formation of a synthetic jet

## Synthetic Jet Ejectors

The principle of jet ejectors or jet pumps has been known for several decades now. A jet ejector consists of a primary high momentum jet driving a secondary airflow through a channel as shown in Figure 2. The low pressure created by a primary jet discharging into the channel results in entrainment of quiescent ambient flow, thus creating an increase in overall flow rate at the channel exit. The overall flow rate can be an order of magnitude higher than the jet flow itself, depending on the operating conditions.

In conventional jet ejectors, the primary jet is created using a pressure source ducted into the entry of a channel. The use of synthetic jets as the primary jet is an attractive option since the only input to the primary jet is electrical, requiring no plumbing and pressure supplies. During the blowing stroke of the synthetic jet, the jet ejector phenomenon is similar to steady jet ejectors, wherein a primary high momentum jet creates a low pressure in a channel resulting in the entrainment of fluid from the quiescent medium. During the suction stroke, the low pressure in the jet cavity results in additional flow entrainment, which is forced out during subsequent blowing stroke.

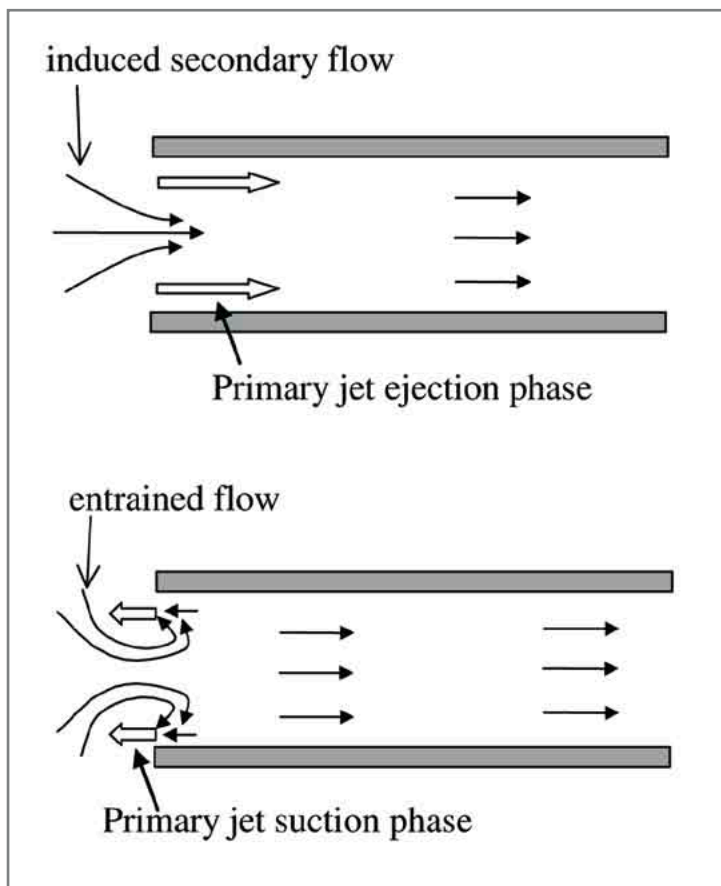

Figure 2: Principle of operation of a jet ejector and the induced secondary channel flow

## Synthetic Jet Thermal Performance Data

Research performed over the last several years at Nuventix has shown significant improvements in airside heat transfer compared to steady flows or fan-type flows. In a channel cooling experiment, Mahalingam et al [1] showed that synthetic jet ejectors have much higher heat transfer coefficients than steady flows of same Reynolds numbers based on the mean channel flow. Figure 3 shows that synthetic jet driven channel flows have higher Nusselt numbers than conventional turbulent channel flow.

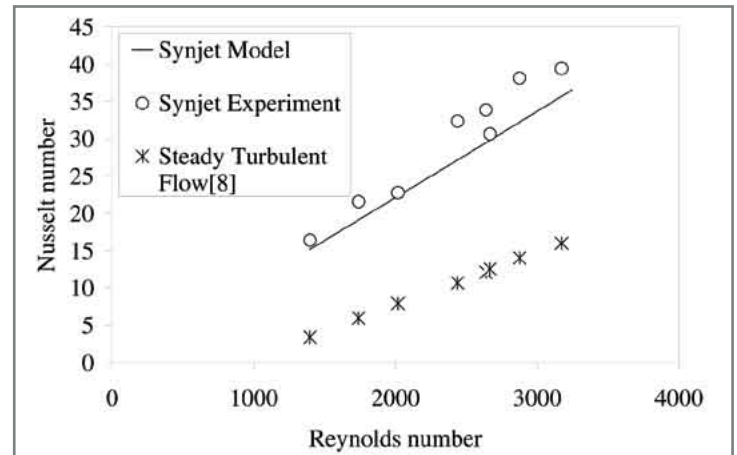

Figure 3: Comparison of predicted and measured Nusselt numbers for the synthetic jet driven channel flow with a correlation by Gnielinski

The following paragraphs describe performance data from a few different case studies of using synthetic jets to cool electronics.

### Heat Sink Integrated with Synthetic Jets

A synthetic jet based PCI-E half-height graphics card cooler was built and tested against a fan-sink solution that was the same form factor. Figure 4 shows the thermal, acoustic and power consumption performance of the synthetic jet solution when compared with the fan solution. The thermal resistance was based on the temperature measured by a thermocouple embedded in the base of the heat sink and inlet ambient to the cooling module. The acoustic data were measured in a hemi-anechoic chamber at 0.5m using a binaural head outside the computer chassis. The A-weighted sound pressure level (SPL) for the jets is significantly lower for the synthetic jet. For a given SPL-A of 40dBA, the synthetic jet has 12% better thermal performance than the fan. The synthetic jets also perform better when comparing Sones for a given performance level, which is a measure of how loud a sound actually feels to the observer.

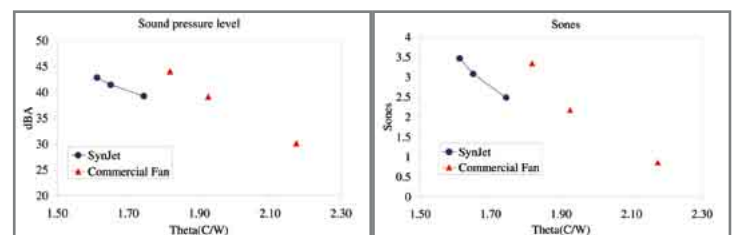

Figure 4: Comparison of the thermal and acoustic performance of a synthetic jet and fan-based PCI-e half height graphics chip cooler

## Fan Augmentation

Synthetic jets can be used to augment the performance of the fan-cooled heat sink. A practical application is in the case of servers where the main fans drive airflow over heat sinks that cool the main processors as well as other components in the chassis. Synthetic jets can be used to improve the thermal performance of the existing fans by reducing flow bypass as well as increase the local heat transfer from the heat sinks. Augmentation using the jets can also lead to overall system improvements in noise and reliability.

To test the efficacy of synthetic jet augmentation, a synthetic jet assembly was retrofitted into a commercially available Newisys 4300 quad-socket, 3U, AMD Opteron rack-mounted model server. Due to the space constraints and PCB layout within the server, two of the processors have reduced-height heat sinks, which conform to a 1U form factor, and two of the processors have full-height 3U heat sinks. The synthetic jet was located directly in front of these shorter heat sinks without modifying the existing server chassis architecture.

Figure 5 shows the case-to-ambient thermal resistance of the CPUs with and without jet augmentation at different fan speeds. The inlet velocities vary approximately linearly in the range of 2.8 to 3.8m/s over the range of fan speeds. At the idling speed of 5500 RPM the thermal resistance drops from about 0.43 °C/W to about 0.35 °C/W, enabling increasing the processor power from 70W to 85W for a constant case temperature of 65°C. At the full speed of 9000 RPM, the performance goes from 0.33 to 0.30 °C/W, enabling an increase in processor power from 92W to 100W at of 65°C.

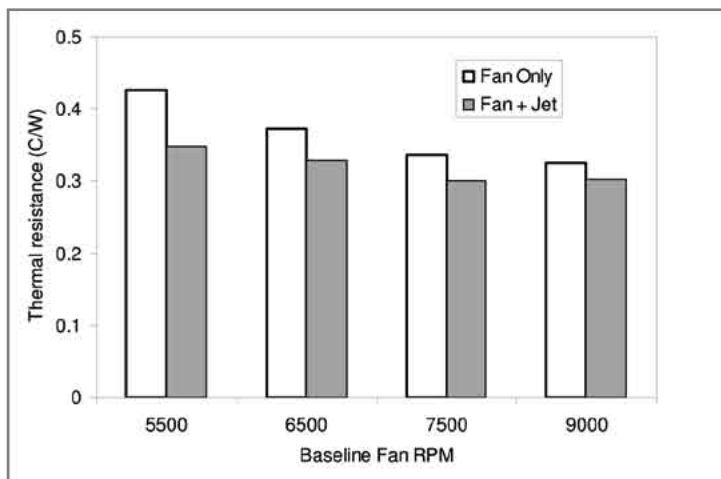

Figure 5: Decrease in thermal resistance due to the synthetic jet augmentation

Jet augmentation also resulted in significant improvement in the noise levels. By operating the fans at lower speed and using the jets to augment the performance of the fans, the SPL of the system was effectively dropped by about 9dBA. In addition to improving the acoustic emissions, the addition of synthetic jets has the potential to improve the system reliability by enabling reduced fan speeds. Since synthetic jets tested for reliability have shown lifetimes of several hundred thousand hours in accelerated life tests, reducing the system

fan speed will affect the system reliability by reducing wear of mechanical fan components, by reducing the rate at which airborne contaminants foul the system and the fan, and by reducing vibrations on the system imposed by the fan.

The packaging flexibility of synthetic jet modules enable cooling applications that are not restricted by the design constraints of a traditional air mover technology. The ability to accurately control the directionality of a synthetic jet enables efficient heat removal from locations where cooling is needed the most. Controlled quantities of airflow can be allocated in different directions from a single synthetic jet module. This allows a designer to cool different components with different heat loads to different temperatures. Efficient local to global coupling can be achieved where part of the airflow is used to cool a targeted component, and then a secondary jet flow is established to drive the hot air out of the system using the same module. Synthetic jet cooling can be integrated into the industrial design of a product. In particular, a synthetic jet can enable unique industrial designs that are not feasible with fan cooled systems.

## Spot Cooling

A 2 x 2 array of hot spots within a system was cooled with a remote synthetic jet module measuring 50 x 50 x 25mm, placed 300mm away from the array. The flexible tubing forming the synthetic jets was 4mm in diameter. During the initial time period the synthetic jet is off while the heaters are energized. The synthetic jets are then turned on and the temperature of the heaters rapidly drops to a steady-state value 2.5 times lower than natural convection. The power consumption for cooling the entire array was 308mW.

What all this means for LED product designers is that SynJets are extremely efficient coolers in a small size. These features make applications such as high-lumen lighting to replace halogen and incandescent bulbs feasible even in enclosed or hot areas such as recessed lighting cans, theater spots and floods, and high-lumen LED projectors as well as large-array lamps.

## Benefits to The LED Industry

### Lifetime

Synthetic jet modules are inherently reliable because they have no frictional parts to rub or wear. There are no bearings, brushes, or motors to wear out and cause failures, whether those failures manifests themselves as mechanical or acoustic failures. Although fan manufacturers have no agreed-upon standard for measuring reliability, L10 life has been proposed as a means of accurate comparison. In reliability measurements the L10 life is the length of time that 90% of the devices tested continue to operate, under given conditions.

Nuventix testing of SynJets has shown that their L10 lifetime is 300,000 hours at 60°C (Figure 6). The best reliability for similar sized fans at 60°C hovers around the 50,000-hour mark and most are much lower than that, near 20,000 hours.



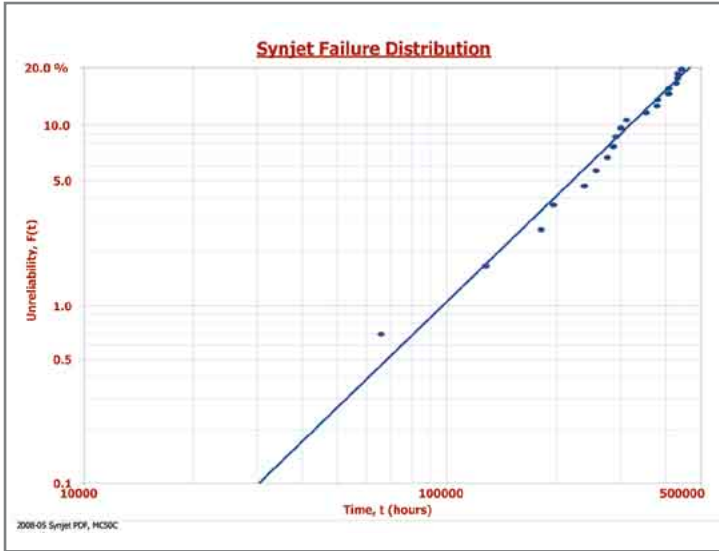

Figure 6: f L10 reliability for synthetic jet modules

The industry standard for LED reliability is B10 life, the time until 10% of the lamps are expected to fail, or B50, the time until half fail. However, since LEDs rarely fail completely but instead lose light intensity over time, this number is not useful in applications where light output is critical. Research has shown that a 30% reduction in lumens is approximately the limit of human perception, so the time to 70% or 50% lumen maintenance (L70 or L50) has been proposed as another standard for rating lifetime.

Current and temperature of the junction greatly affect the life of LEDs. Figure 7 [2] shows B50 and L70 data for a Luxeon K2 LED rated at 60,000 hours. Up to 120°C, the rated reliability is assured at all currents. However, the dropoff is rapid at temperatures higher than 120°C for all current levels. One conclusion is that 60,000 hours is all that designers can be assured for LEDs at this time, even though some sources claim lifetimes of up to 100,000 hours. In either case, the 300,000-hour L10 lifetime of SynJets surpasses even the most optimistic estimates of LED life. The L70 values also underscore the need for reliable active cooling to extend the life of LED lamps.

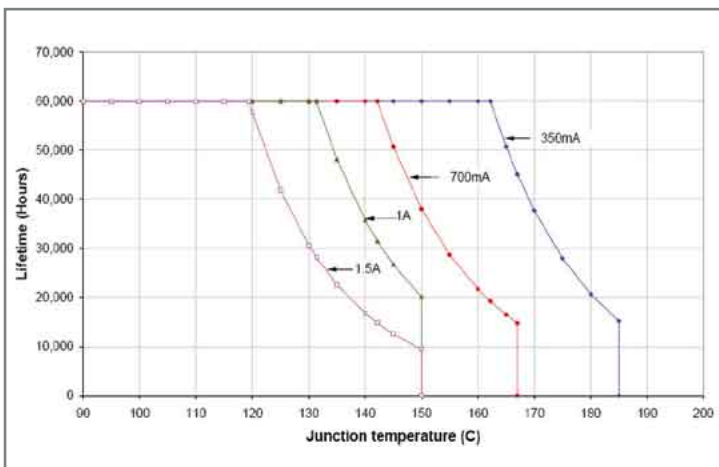

Figure 7: B50 and L70 lifetimes across current and temperature variables

### Noise Level

The volume of airflow needed by a SynJet to cool LEDs is very low because synthetic jets are so thermally efficient. Low flow rate translates to low acoustic emissions. In addition, the absence of frictional parts eliminates friction noise. Synthetic jets of a size suitable for cooling LED lamps are virtually silent. MR-16 and PAR-38 LED lamps currently available have a sound pressure level of 20-22 dBA at one meter or less. This is equivalent to the sound of someone breathing one meter away; that is, undetectable in ordinary environments.

### Power Consumption

Synthetic jets consume very little power; therefore, they are an ideal match for LEDs in terms of "green" concerns. An ANSI standard size LED MR-16 lamp dissipates 5 to 6 W through natural convection. With a SynJet cooler that is currently available, an LED MR-16 lamp can dissipate 15 to 20 W, increasing the lumen output 3 to 4 times while using only 750 mW of power for cooling.

In a LED PAR 38 lamp, natural convection might dissipate 15 to 20 W under ideal conditions and less in applications such as recessed lighting. With a SynJet cooler, an LED PAR 38 lamp can dissipate 35 to 50 W, increasing the lumen output 2 to 2.5 times while only consuming far less than 2 W of power for cooling.

### Example 1: Higher Efficiency of MR16 LED Lamp



Assume that a retail space uses 10 banks of three 50-watt MR16 halogen lamps each, for accent spotlighting. Each lamp uses 50 watts, so the total wattage consumed is 1500 W. Passively cooled LED MR-16s are not currently capable of producing enough lumens to replace 50-watt halogen lamps. However, active cooling using a SynJet makes this

market possible today. If the 50W halogen lamps are replaced with actively cooled LED MR 16s that produce 900 lumens (brightness equal to a 50W halogen bulb), at today's top achievable output of 40 lumens per watt, an LED MR-16 would use 25 watts.

$$\frac{900 \text{ lumens}}{40 \text{ lumens/W}} = 22.5 \text{ W}$$

Add 750 mW for the SynJet module, and the total energy use is 23.25 W per lamp and just under 700 W for the store, or 54% less electricity than halogens use.

$$22.5 \text{ W lamp} + 0.75 \text{ W SynJet} = 23.25 \text{ W}$$

$$23.25 \text{ W} * 30 \text{ lamps} = 697.5 \text{ W}$$

$$\frac{(1500 - 697.5) \text{ W}}{1500 \text{ W}} = 0.535 = 54\%$$

At today's efficacy, replacing 50W MR16 halogen lamps with SynJet-cooled LED lamps could cut electricity use by more than half.

#### Example 2: Higher Efficiency of PAR 38 LED Lamp



Assume that a hotel uses 500 PAR 38 incandescent lamps for general lighting. Each lamp produces 1800 lumens and consumes 120 W, so the total wattage consumed is 60 kW. The passively cooled LED PAR 38 lamps that are currently available consume about 8-12 W but use a large array of LEDs and only produce 200 lumens. This lumen output is not enough to replace existing 120W PAR 38 lamps. However, with active cooling using a SynJet, an LED PAR 38 can operate at much higher power and produce enough lumens to compete with 120W incandescent lamps. At today's top achievable output of 40 lumens per watt, an LED PAR 38 would use 45 watts.

$$\frac{1800 \text{ lumens}}{40 \text{ lumens/W}} = 45 \text{ W}$$

Add 2 W for the SynJet module, and the total energy use is 47 W per lamp and just under 23.5 kW for the hotel, or 61% less electricity than incandescent lamps use.

$$45 \text{ W lamp} + 2 \text{ W SynJet} = 47 \text{ W}$$

$$47 \text{ W} * 500 \text{ lamps} = 23.5 \text{ kW}$$

$$\frac{(60 - 23.5) \text{ kW}}{60 \text{ kW}} = 0.608 = 61\%$$

At today's efficacy, active cooling using SynJets makes efficient LED PAR 38 lamps possible that could replace incandescent lamps and reduce electricity use by almost two thirds.

## Conclusion

This article describes a novel technology for airside heat exchange called synthetic jets. Synthetic jets are produced by the oscillation of a diaphragm bounding a cavity and are comprised of the ambient fluid surrounding the jet module. This method of producing an unsteady air jet enables compact and unique form factors for cooling electronics and LEDs. Since synthetic jets are inherently pulsating and turbulent, they produce higher heat transfer coefficients than typical fan flows and can remove heat from a surface with lesser airflow.

The efficient, quiet cooling that synthetic jet ejectors provide will undoubtedly be integral to the future of higher-lumen LED applications. Having the option of a cooling system that matches or exceeds the LED in long life, energy efficiency and the synthetic jet module's complete flexibility of form gives designers a powerful tool and unlimited possibilities for combining with any heat sink design. ■

#### References

- [1] Mahalingam, R., Rumigny, N., and Glezer, A., "Thermal Management using synthetic jet Ejectors", IEEE-CPMT, 27, 3, Sept. 2004  
 [2] <http://www.lumileds.com/pdfs/WP12.pdf>. Accessed on 11/07/07.



# DPX 2008 The 16th DPX Photonics Exhibition

## 多人行光电展 2008 International Photonics & Display (China) Exhibition

Approved by : Ministry of Science & Technology of PRC.

Special Exhibition Sections: 1. Optics ; 2. LED and Semiconductor illumination ; 3. LCD Flat Panel Display ; 4. Laser

**PERIOD:** from June 19th to 21st, 2008

**VENUE:** Shenzhen Convention & Exhibition Center, China



**SPONSORS:**

Chinese Institute of Electronics (CIE)  
 Shenzhen Association of the Optics & Optoelectronic  
 Shenzhen E-Dowell Industrial Co., Ltd.

**ORGANIZERS:**

Shenzhen E-Dowell Industrial Co., Ltd.

[e99999.com](http://e99999.com)  
 多人行电子网

Synchronization:  
 2008 International Electronic Equipments and Components (China) Exhibition

Welcome to E-Dowell electronic exchange website: [en.e99999.com](http://en.e99999.com)  
[www.e99999.com](http://www.e99999.com)

★ If you participate our 2008 Exhibition, you can get a large-scale data type of dynamic exchange service in E-dowell electronic exchange website and use it for free until May of 2009.

★ One of the most professional Photonics & Display Exhibition in China (The total exhibition area is 80,000 square meters).

★ DEX Electronic Exhibition was awarded the prize of "the Best Representative of 25-year Development in Shenzhen City" in Nov., 2005.

Organizing Committee: Shenzhen E-Dowell Industrial Co., Ltd

Contact Person: Ms. Jin Ms. Zhang

Shenzhen Office: +86-755-83502448, 83502094

HongKong Office: 00852-23419810

E-mail: [dex@e99999.com](mailto:dex@e99999.com)



DPX Exhibition connects the world market with you!

# DPX 2008 The 16th DPX Photonics Exhibition

## 多人行光电展 2008 International Photonics & Display (China) Exhibition

Approved by : Ministry of Science & Technology of PRC.

**PERIOD:** from June 19th to 21st, 2008

**VENUE:** Shenzhen Convention & Exhibition Center, China

Special Exhibition Sections:

- ◇ Optics      ◇ LED and Semiconductor Illumination
- ◇ Laser      ◇ LCD Flat Panel Display

One of the most professional Photonics & Display Exhibition in China

Synchronization: 2008 International Electronic Equipments and Components (China) Exhibition

# TICKET

Welcome to E-Dowell electronic exchange website:

[Http://www.e99999.com](http://www.e99999.com)  
[Http://en.e99999.com](http://en.e99999.com)





# There is a new name for sucess with LED – TALEX.

[www.tridonicatco.com](http://www.tridonicatco.com)



TALEXengine

With TALEXengine TridonicAtco sets another milestone in modern lighting technology – a complete system that builds the basis for a wide range of intelligent value-added lighting solutions. All the benefits of modern LED technology are built into this sophisticated but simple to use product: slim design, long life, true white light quality and not least the choice of application-specific colours. TALEXengine: More than just LED.

a world of bright ideas®

TRIDONIC.ATCO

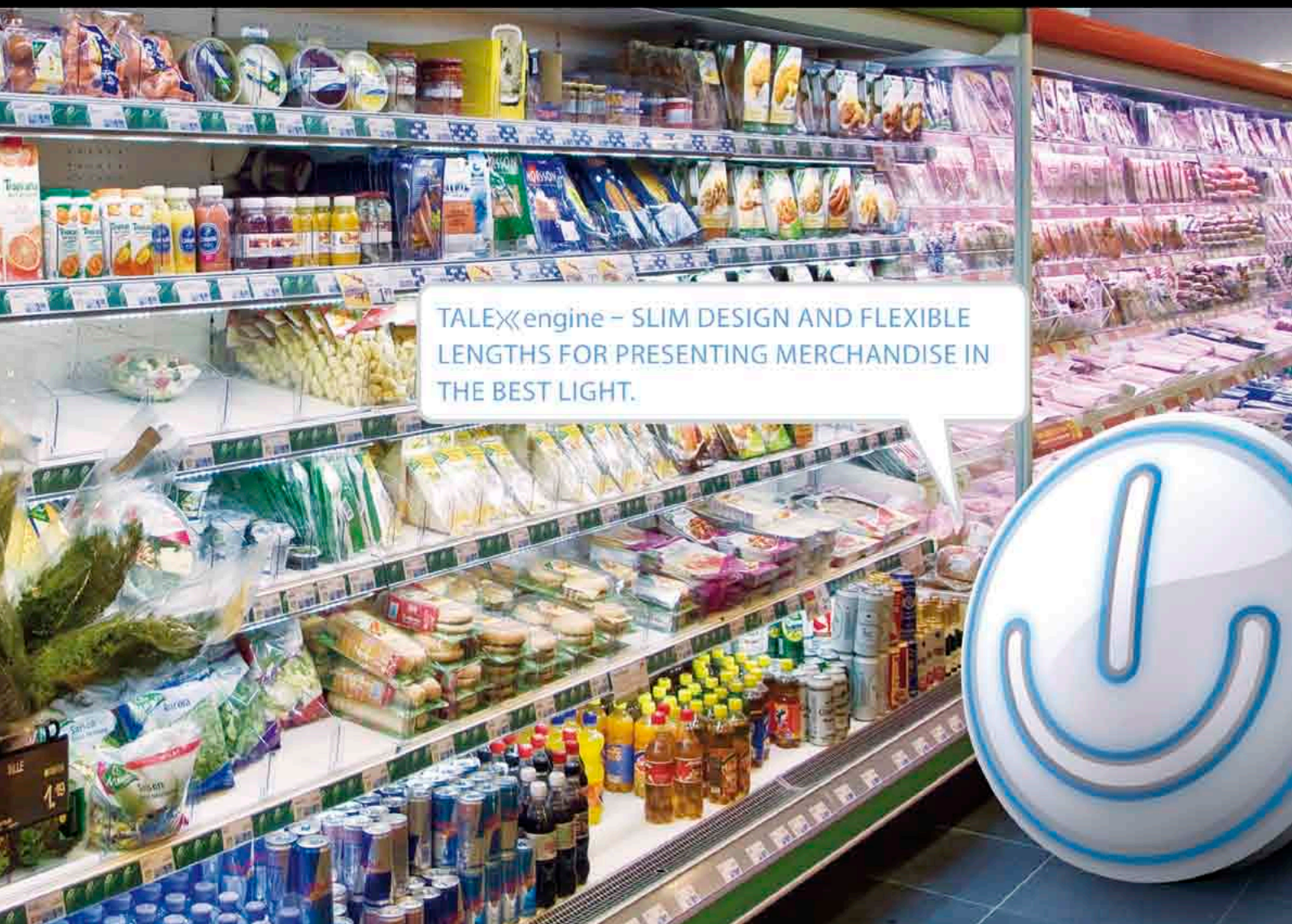

TALEXengine – SLIM DESIGN AND FLEXIBLE LENGTHS FOR PRESENTING MERCHANDISE IN THE BEST LIGHT.

