

**LED Primary &
Secondary Optics**
Important Parameters for
Choosing LED Optics Correctly
Optical Materials and Lifetime
Beam Shaping

LED professional Lab
Electrical Considerations
of LED Bulbs

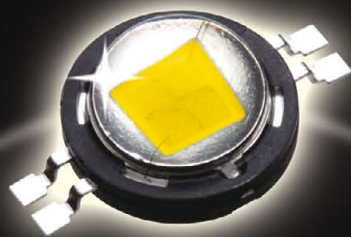

Acriche

World's First AC-Driven Solid State Light

Z-power LED

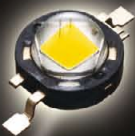

Lamp LED



"A Company of Good People"

Top View LED



High Flux LED



Chip LED



Side View LED



Seoul Semiconductor...

is global leading LED maker.
is the center of global attention with cutting edge LED technology for the next generation lighting.
considers the value for customers as their top priority
designs sustainable future for the happiness of human beings.

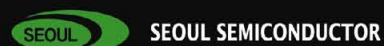

www.acriche.com

Headquarters +82-31-364-3787

China +86-755-8204-2307

Europe +49-69716-750111

Japan +81-3-5360-7620

North America +1-310-324-7151

Quality Comes First



Solid-State-Lighting (SSL) is the high-quality lighting solution for the 21st century. Firstly, SSL is an efficient technology minimizing the light collection losses because of the directional light operating at high efficiency values and lower voltages. Secondly, SSL enables high design flexibility in size, in dynamic color tuning, in dimming, in negligible infrared and UV emission, and in a wide range of CCTs and CRIs. Thirdly, SSL is a reliable technology with a lifetime of more than 50,000 hours, with reduced maintenance costs, and with high temperature and shock robustness. Finally, SSL is environmentally friendly causing reductions in fossil fuel consumption and carbon emission.

Now is the time to increase the quality of light. As a first step, for light bulbs. Worldwide about 12 billion electric light bulbs are installed – a huge energy waste. The time is ripe to begin afresh with SSL, and avoiding a switch over to the old and problematic fluorescent lighting, which has to be treated as toxic waste and has not gotten the end-user's acceptance for years.

A primary quality factor is system efficiency. LED system efficiency values are mainly driven by the LED performance itself, the optical losses, the thermal losses and the driver losses. The optical efficiency, as a part of the overall system efficiency, is estimated by examining light loss. A main source for light losses is the secondary optics. The secondary optics is any optical system that is not part of the LED itself, such as a lens or diffuser placed over the LEDs. Efficiency comparisons of optical systems should also include lifetime and temperature behaviors, since the materials vary differently under stress parameters ending up in maybe unexpected end-of life lumen outputs.

The efficiency values and the light quality in general are the focal point nowadays. Nevertheless the behavior of the LED technology in respect to the electrical parameters is of interest as well. New quality factors are relevant for establishing the needed confidence into the market. Quality factors like security, disturbances, or maintenance will play an increased role in the quality aspects of SSL.

The September/October 2009 *LED professional Review (LpR)* issue highlights two important quality aspects, the design approaches to increase the efficiency in the optical parts ranging from material aspects to optical design criteria and the quality status of recent LED products in safety, lifetime and electrical aspects. The tests were performed in the LED professional Laboratory (LpL) a brand new established service operated by LED professional.

We would be delighted to receive your feedback about *LpR* and LpL or tell us how we can improve our services. You are also welcome to contribute your own editorials.

Yours Sincerely,

A handwritten signature in blue ink, appearing to read 'Siegfried Luger'.

Siegfried Luger

Publisher

Imprint

LED professional Review (LpR)

ISSN 1993-890X

Publisher

Luger Research e.U.
Institute for Innovation & Technology
dep LED professional
Faerbergasse 15, Haus Rot
A 6850 Dornbirn, Austria / Europe
phone +43 5572 394 489
fax +43 5572 394 489 90
editors@led-professional.com
www.led-professional.com

Publishing Editors

Siegfried Luger
Arno Grabher-Meyer
Chrystyna Lucyk

Accounts Manager

Silvia Girardelli

Front-page picture

ATG Replacement Bulb
Artwork: Thomas Klobassa, ©LED professional 2009

Copyrights – Luger Research e.U.

The editors make every reasonable effort to verify the information published, but Luger Research e.U. assumes no responsibility for the validity of any manufacturers, non profit organisations or individuals claims or statements. Luger Research e.U. does not assume and hereby disclaims any liability to any person for any loss or damage caused by errors or omissions in the material contained herein, regardless of whether such errors result from negligence, accident or any other cause whatsoever. You may not copy, reproduce, republish, download, post, broadcast, transmit, make available to the public, or otherwise use of LED professional Review (LpR) content without the prior written permission from Luger Research e.U. – Institute for Innovation & Technology, Austria. ■



LED professional Review (LpR) – Annual Subscriptions

LpR Digital Magazine

- 6 issues
- pdf download
- high resolution pictures and graphs
- printable
- commercial use
- access to all previous issues
- access to LED professional Lab articles
- bimonthly Patent Report
- "Hot News" service
- Euro 78.80
- <http://led-professional-review.com>

LpR Printed Magazine

- 6 issues
- Euro 158.40

Next LpR Issue – Nov/Dec 2009

- LED Testing, Simulation & Manufacturing Equipment

Content

Editorial	p1
Imprint	p2
Product News	p5
Announcements	p12

■ Application

Electrical Considerations of LED Bulbs

by Siegfried Luger, Arno Grabher-Meyer and Lukas Gorbach, LED professional p14

Optocouplers – A Critical Design Element in LED Bulbs

by Arno Grabher-Meyer, LED professional p17

Case Study – LED Solution Offers Advantages for Henkel Waste Water Plant

by Gordon Routledge, Dialight, Boris Viner, Consultant to Dialight p20

■ Technology

High Efficiency Reflective Mirror Type LED

by Shigeru Yamazaki, Alpha-One Electronics Ltd. p24

■ Optics

All Facts for Choosing LED Optics Correctly

by Tomi Kuntze, LEDIL Oy p28

Primary and Secondary Optic Materials – LED Luminaire Performance and Lifetime

by Thomas Brukilacchio, Ph.D., Innovations in Optics Inc p32

Shaping the Beam – the Role of Primary and Secondary Optics

by Rudi Hechfellner, Philips Lumileds; Dave Cohen, Fraen Optical Manufacturing Group p40

Save Space with Focus Tunable Lenses

by Mark Blum, MSc EE, Manuel Aschwanden, PhD, David Niederer, MSc ME, Optotune p43

Parameters to Consider for LED Optics Design

by Guido Campadelli, Fraen Corporation p46

LED professional – Patent Report	p48
-----------------------------------------	-----

Advertising Index

SEOUL SEMICONDUCTOR	p C2
LED FORUM MOSCOW 2009	p 4
VOSSLOH-SCHWABE	p 9
EDISON	p 13
NEC	p 19
FUJIPOLY SINGAPORE	p 23
JENOPTIK-PS	p 25
LEDLIGHTFORYOU	p 25
LED CHINA	p 27
MINLEON	p 33
LIGHTING KOREA	p 39
RECOM	p 45
CIE VIENNA	p C3
ARROW ELECTRONICS	p C4



3rd INTERNATIONAL LED FORUM MOSCOW LEDS IN LIGHTING TECHNOLOGIES

Time: November 11th – 12th, 2009
Venue: Expocentre Fairgrounds, Moscow



Attend one of the biggest conferences on LED technologies in Europe and Russia.

- >> 200 participants in 2008
- >> exclusive insights into investment plans of Russian companies
- >> simultaneous translation into English
- >> in the frame of INTERLIGHT MOSCOW, Russia's leading trade fair for lighting, light technology and intelligent building technology



Premium Sponsor:

OSRAM
Opto Semiconductors

Detailed information on speakers and hours:

www.ledforum-moscow.com

Eugene Dolin , ++7-985-290 60 99 , dolin@ledforum-moscow.com

Product News

Acriche Family Exceeds DC LED System Efficiency for Warm White LEDs

Seoul Semiconductor, a world-leading LED manufacturer, announced the introduction of the Acriche 4, a breakthrough alternating current LED product, in major markets around the world today.



Acriche 4W PAR16 board, assembled with the brand new Acriche A4 series AC LEDs.

The A4, which will be mass produced and available this quarter, has the world's best luminous efficiency of 75 lm/W, and is capable of replacing warm white incandescent and compact fluorescent light sources in many consumer and commercial applications.

Currently, white LEDs are divided into two major markets: products with a high Color Rendering Index (CRI) greater than 85, which is close to natural light, and products with a normal CRI of 70 to 80. High CRI products will often be significantly less bright than their lower CRI counterparts, but due to their similarity to natural light, high CRI sources are excellent for high quality light applications. LEDs with normal CRI achieve a greater brightness but have the disadvantage of being quite different from natural light.

The new and highly innovative Acriche A4 product, however, achieves both a high CRI and superior brightness. The A4 devices have a color temperature of 3000 K and include multiple new technologies that provide excellent efficiency of 75 lumens per watt (lm/W) with a high CRI of 85.

It is the first time that Alternating Current (AC) LEDs have achieved better luminous efficiency than LEDs with Direct Current (DC). Seoul Semiconductor stated that "With the mass production of the Acriche A4 series, we will be able to provide both high quality and normal use markets with light sources that have exceptional performance and lower prices." ■

Enfis Introduces the "Innovate" Series of Ultra-Bright White LED Arrays

Enfis Group Plc, an innovator of intelligent LED lighting systems and technologies, announced the introduction of a new line of ultra-bright white LED arrays that offer fixture manufacturers and lighting designers rapid design and integration opportunities.



Enfis "Innovate" series of ultra-bright white LED arrays: Flexible configurations include built-in intelligence with Warm White and Hi-CRI.

Based around Enfis' proprietary LED control technology, each Innovate Series array provides the optimum balance between lm/W, lm/USD, total lumens and component size – making them an easy choice for lighting fixture manufacturers and lighting designers for integration into their next product or project.

The Enfis Innovate Series of LED arrays sets a new standard for Ultra-Bright White Light with system configurations delivering over 2500 lm of Hi-CRI (>92) warm white (2800 K), neutral (3600 K) and cool white (6500 K) light with rated lifetimes of more than 50,000 hours. All configurations are fully dimmable and include the option to monitor array temperature and precisely control lumen output. A variety of premium optics also provides a choice of beam patterns ranging from 14 to >120 degrees. Enfis also designs and manufactures its own line of feature-rich LED drivers and power supplies – providing customers with a complete turnkey solution.

"In order to take full advantage of LED lighting technology, lighting fixture manufacturers and designers have had to engineer around each individual component," said Dan Polito, president of Enfis Lighting North America. "The Enfis "Innovate" series of LED arrays are just another example of how they can now create an LED lighting delivery system from a wide selection of available configurations."

The Enfis Innovate series of LED arrays offer a wide variety of general illumination applications including, interior/exterior architectural, street and perimeter, commercial retail, hospitality and residential recess down lighting, and portable and solar lighting systems.

Polito also noted that each Enfis Innovate LED array delivers light output and lumen maintenance that facilitate ENERGY STAR® and similar lighting efficiency and performance programs. As are all Enfis LED products, the Innovate Series of LED arrays are fully compliant with the EU's RoHS Directive restricting hazardous substances. ■

New High Power LED Family AS-5050WxA2-C6-H1

The LED lamps from the renowned manufacturer Alder, distributed by MSC Vertriebs GmbH, excels with high efficiency, a complete homogeneous light field and a long lifetime.

The AS-5050WxA2-C6-H1 LED lamp is based on a 12 chip technology and an innovative high efficiency phosphor, outstanding due to its considerably advanced visibility of red colours.

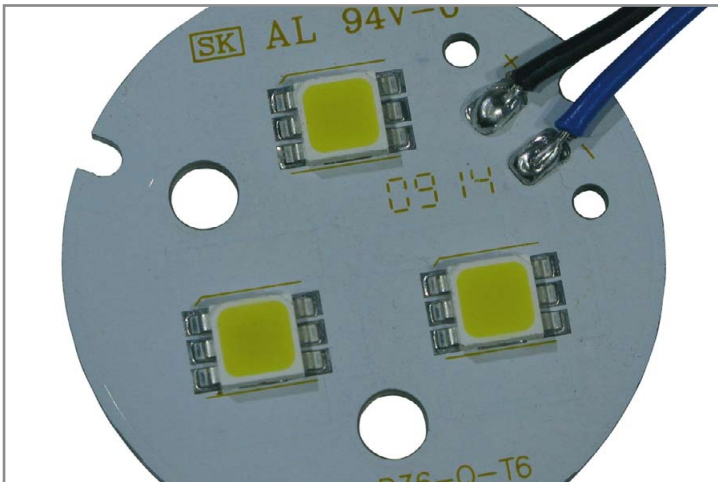

MR16 board with the new AS-5050WxA2-C6-H1 LED lamp from Alder.

The colour temperature measures 3000-6500 K. The main criteria for selecting AS-5050Wx for lighting solutions are the extremely high efficiency factor and the low power dissipation of only 1 W operating at 10 V and 100 mA. The optical efficiency factor of the standard version AS-5050Wx ranges up to 95 lm/W.

Alders second series is called AS-5050WWA2-C6-HH1. This high CRI-device features 3250 Kelvin with a colour rendering index of 93. The R9, which is the value for the colour random authenticity for parts with a red surface, is outstanding. The optical efficiency factor ranges up to 70 lm/W. ■

Edison Opto Improves Uniformity of White Light with MAPLE Coating Technique

Mixing luminescence phosphor with silicone and dispensing it on a blue-light emitting chip is a common LED packaging method in producing white light. The quality of white light depends heavily on the uniformity of phosphor on the blue die. Often, when coupling secondary lenses on white LEDs, it will reveal yellow rings. Such yellowing greatly shadows the quality of white light.

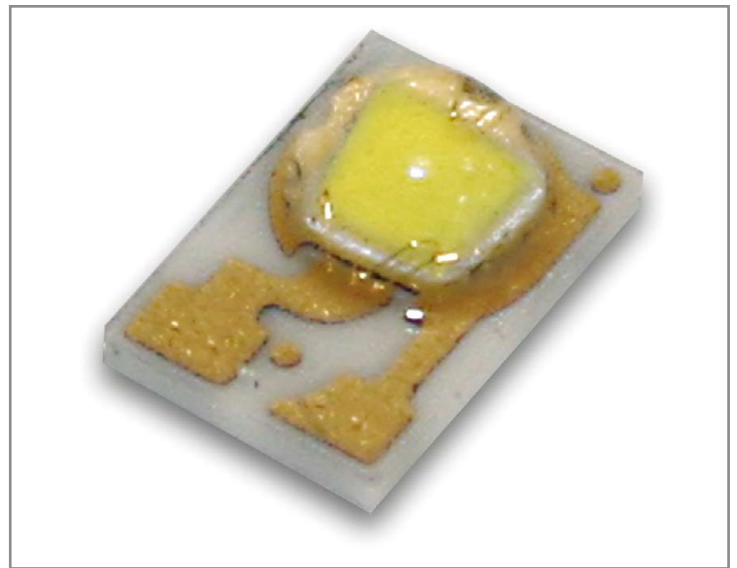

Edison Opto's Edison Federal LED with MAPLE coating.

To overcome such a disadvantage and offer pure white LED light, Edison Opto has successfully enhanced its packaging abilities by offering a highly uniform white light LED.

To improve the CCT uniformity of white LED, Edison Opto incorporates the principle of ceramic injection forming, combined with unique, patent-pending coating technique: Multi-Axial Phosphor Layer Envelope (MAPLE) process, to effectively form a thin layer of phosphor around the emitting faces of an LED. The spatial uniformity can be controlled within the McAdam's-Ellipse-3 and with a CCT variance within ± 300 K. Moreover, through fine tuning of the recipe, the CCT can fully satisfy various ANSI binning that are widely adapted among SSL manufacturers.

Different from traditional phosphor gel dispensing techniques, the proprietary MAPLE process can maximize the value proposition by delivering highly uniform white light. Edison Opto is going to fully implement its MAPLE technology into its range of high-power LED products for lighting applications. ■

LedEngin Introduces White 40 W LED Light Source

LedEngin, Inc., an SSL company specializing in high performance LED products, introduces an ultra-bright, ultra-compact 40 W LED light source available in warm, neutral and daylight white color temperatures. It is the first of its kind with record luminous flux density in a compact 9 mm x 9 mm footprint. The multi-chip LED is capable of 2000+ lumens in neutral and daylight white color temperatures and 1500+ lumens in warm white. This industry-leading LED is an excellent source for general lighting, down lighting, architectural and street lighting applications. The unparalleled thermal resistance of 0.7° C/W allows the extreme power density from such a small light source to create a compact and efficient optical system. LedEngin 40 W LED light source exceeds the luminance of competing LED solutions by 6-10 times solving a major challenge of working with larger LED sources in flood and spot lighting applications. The high quality materials and the patented packaging technologies are chosen to optimize light output and minimize stresses resulting in superior reliability, color point stability and lumen maintenance well beyond industry standards. The robust packaging allows the 40 W LED to meet JEDEC Level 1 Moisture Sensitivity Levels for unlimited product floor life.

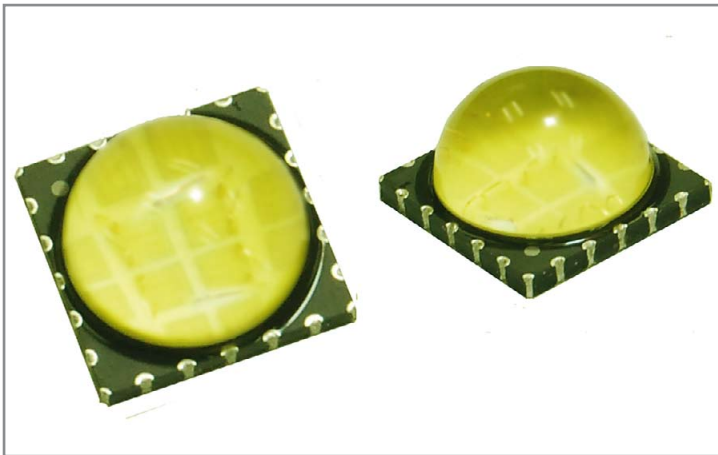

LedEngin's ultra-bright, ultra-compact 40 W LED light source.

LedEngin also offers 24° and 35° lenses specifically optimized for this LED delivering the highest quality and quantity of light within the beam. The secondary optic maximizes usable light and provides a smooth light gradient with uniform color across the beam. There are no hot spots, shadows, rings or fringe effects that other lighting solutions, including other LED sources, exhibit. By utilizing these patented lenses, the LedEngin emitter/lens combination performs exceptionally without additional filters or diffusers to create the highest quality lighting solution available today.

"Our newest high density, high flux LED offers the brightest 40 W light source with the highest light output and highest flux density for architectural and general lighting applications," said Dr. Xiantao Yan, Founder and Chief Technical Officer, LedEngin, Inc. "With record low

thermal resistance, and thermally and electrically isolated pads, this package is ideal for downlighting fixtures and retro-fit lamps. By utilizing specially optimized lenses our 40 W products continue to deliver the maximum lux on target, or usable light, that LedEngin products are known for."

The 40 W LED and lenses are available today. Initial samples are available on a custom MCPCB for easy installation and alignment with the lens and lens holder. ■

Dominant Semiconductor Releases New RGB SPNovaLED

Dominant introduces the new high intensity RGB SPNovaLED (NMRTB-USD) of its SPNovaLED series, replacing the existing NMRTB-USS device. The utilized RGB technology of this LED also allows for driving each chip in the package individually to mix and match any requested colour even white; to provide balanced lighting distribution. With an operating current of 250 mA this LED features a typical luminous intensity of 9,000 mcd for Red, 18,000 mcd for True Green and 4,500 mcd for Blue.

Applications:

- Signage: full colour display video notice board, signage, special effect lighting
- Lighting: architecture lighting, general lighting, garden light, channel light

Features:

- Super high brightness surface mount LED.
- High flux output.
- 125° viewing angle.
- Compact package outline (LxWxH) of 6.0x6.0x1.5 mm.
- Ultra low height profile - 1.5 mm.
- Designed for high current drive; typically 250 mA.
- Low junction-to-solder point thermal resistance; RTH js = 50 K/W.
- Qualified according to JEDEC moisture sensitivity Level 2.
- Compatible to IR reflow soldering.
- Environmental friendly; RoHS compliance.



The new RGB SPNova LED from Dominant.

This new RGB SPNovaLED offers an excellent lifetime due to its silicone encapsulation and low thermal resistance of the housing, converting it to an unimpeachable MultiLED product. In terms of the design and size of the package the dimensions are equal to the other SPNovaLEDs. However the viewing angle was designed to 125° to ensure superior colour mixing among the colours. This LED is a true high intensity light source that leverages the benefits to a greater stability and an extended lifetime.

Based on its advantages and dynamic performance DOMINANT's new RGB SPNovaLED is the best choice for a variety of applications such as full colour display board, signage, decorative lighting, channel light and architecture lighting, outperforming similar competition devices in almost every significant area. ■

Star-Shaped Heatsinks from Fischer Elektronik

High Power LEDs (HP) and High Brightness LEDs (HB) for lighting purposes offer great opportunities for the lighting industry, as LEDs are energy-efficient and potentially highly reliable.

In view of the high power density of these HP/HB LEDs the major challenge is safe and effective heat dissipation, in order to ensure trouble-free functioning, good light yield and a long service life.

The shape of lamp housings or the positions in which they are situated is often rotationally asymmetric, so that round bodies are required for heat dissipation.

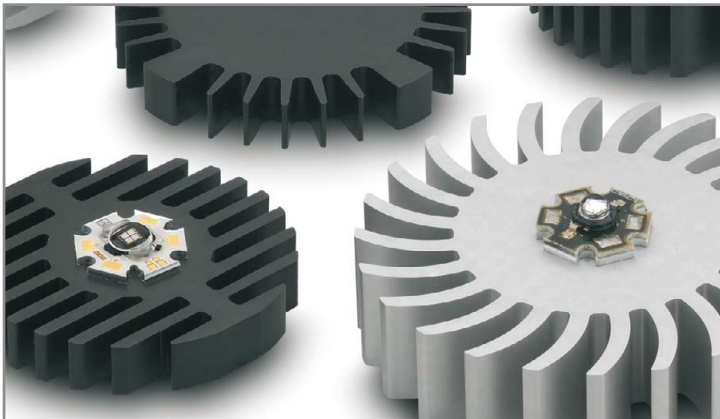

Examples of the new series of Fischer Elektronik's circular heatsinks.

In order to dissipate the heat from these LEDs, Fischer Elektronik has developed a range of aluminum heatsinks, the dimensions of which match the majority of current round housing designs. These heat sinks, which are offered with different diameters and contours, are available in different sections of different lengths to suit specific heat dissipation applications.

The LEDs are fastened onto the heat sink using thermally conductive, double sided adhesive tape, 2-component thermally conductive adhesive or screws. In the standard version, the surface is black anodised or of natural colour.

In addition to standard heatsinks, specially modified and customized versions are developed and manufactured. ■

Optoga: New Age, New Light – CRI 95 Achieved

Optoga introduced an update on their line of light engines called OptoDrive. With integrated driver and secondary optics, they are plug-and-play modules.

OptoDrive Felicia and Clara are complete light modules that can easily be fitted into most types of light fittings. The compact modules open up completely new opportunities for exciting and functional design solutions. The modules give superbly balanced light, both in terms of colour reproduction and spread, making them usable in many different types of light fitting.

Even due to their small size, Felicia and Clara offer excellent colour balance and spread of light. The colour rendering index of Ra 93 is far beyond the standards required of workplace lighting where tasks demand extra accuracy in colour perception. Felicia and Clara are available with light that has a warm white, normal white or cool white colour temperature.

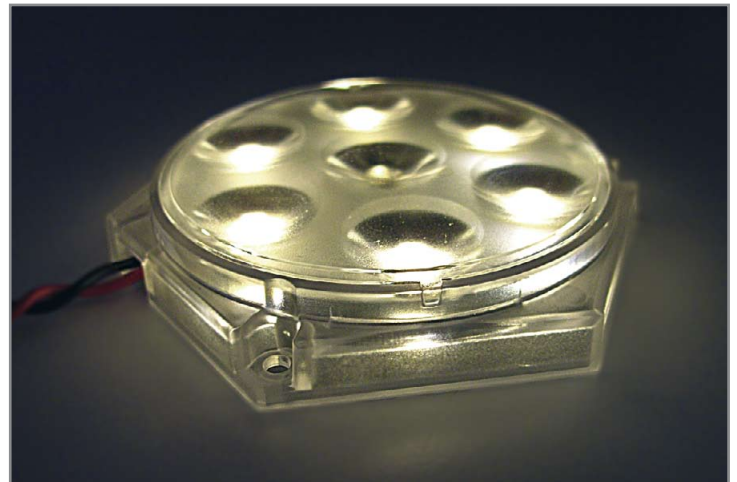

The OptoDrive Felicia and Clara modules.

Consumer demands for having a light colour that as much as possible has the same temperature as a regular lightbulb have created new developments. The LEDs have had problems meeting the demand for warm white light, but through the possibility of having a very strict colour temperature measurement Optoga introduce LEDs from 2650 K up to 4500 K with excellent CRI. They are also very simple to add to your light fittings, giving you a range of sales arguments.

Main Performance Data:

- Luminous flux: 180 lm (Felicia) and 540 lm (Clara)
- Correlated colour temperature (CCT): 2950, 4000 and 5350 K
- Colour rendering index (CRI): 93
- Beam spread: 10°, 30°, 60° and asymmetric
- Supply voltage: external driver, 12–36 V DC or 230 V AC
- Power consumption: 1–12 W
- 230 VAC or low voltage with or without built-in driver
- Dimmable with PWM from DALI or DMX, etc.
- Highly compact all-in-one module
- Simple fitting, no cap, just two screws and a plug

OptoDrive modules have achieved CRI Ra above 95 in an independent spectral distribution test performed by the Swedish national test institute, SP.

Recently the development of better phosphors has improved LED performance and in the latest tests, the result gives a CRI 95 with flux levels that match the best "low" CRI products. The compact Optodrive modules open up completely new opportunities for exciting and functional design solutions with an energy efficiency of up to 80 lm/W.

The modules give superbly balanced light, both in terms of colour reproduction and spread, making them suitable for many different types of light fitting. The tests were made at a correlated colour temperature (CCT), 3600 K, and, in future, with the possibility to achieve this performance at even higher CCT values. The colour rendering index value achieved by the Optodrive modules is far beyond the standards

required of workplace lighting where tasks demand extra accuracy in colour perception. It is even possible to use these light sources in applications such as medical lights, kitchen lighting, food retailing, art galleries, fashion or clothes displays and similar applications which require excellent colour reproduction.

The demands of having a CCT that closely replicates the same temperature as a regular light bulb have driven the development of these modules. LEDs have had problems meeting the necessity for warm white light with colour temperature values between 2650 K and 4500 K with excellent CRI. The Optodrive modules completely satisfy this requirement. ■

Eco-friendly, Energy-Efficient PAR38 LED Frosted Floodlight Bulb

LEDtronics® announces the latest additions to its series of energy-efficient replacements for PAR38 light bulbs. The high-power PAR38-12X2WF series of warm-white and pure-white frosted soft-flood bulbs offer long-lasting durability, low power consumption and money savings. They run a wide range of voltages from 85 to 265 VAC requiring no special adapters, while consuming less than 18 W.



PLDC Professional Lighting Design Convention, Berlin
29th – 31st October 2009



Interlight, Moscow
10th – 13th November 2009

- **very high luminous flux**
- **available in three different shapes (Triple, Line and Flood)**
- **simple plug and play connection technology**
- **various light distribution options using optic modules**
- **long service lifetime due to optimal thermal management**
- **dimnable**



Setting the Scene with Vossloh-Schwabe

Vossloh-Schwabe's new HighPower-Mono system welcomes you to a previously uncharted galaxy of fresh design options for general lighting using LED. Guaranteeing a very high luminous flux and available in white, warm white, blue, green and red, the new LED modules are ideal for installation in luminaires. Great flexibility and 24V operation are further advantages of the HighPower-Mono system.

Whatever your needs may be, Vossloh-Schwabe LED technology can help you to set the scene.

Vossloh-Schwabe: A New Lighting Experience

www.vossloh-schwabe.com

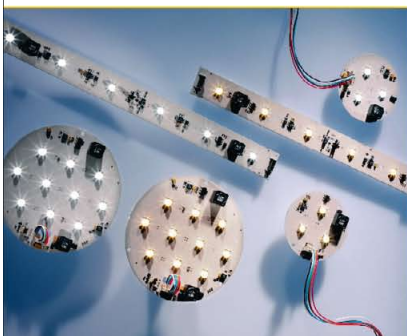



The high-power PAR38-12X2WF series directly replace halogens and metal halides up to 90 W, providing 77%-85% energy savings.

In addition, the series PAR38-12X2WF boasts an outstanding color quality, a wide-focused beam of around 90 degrees, powerful 661 (XIW) and 808 (XPW) lumens of brightness, easy drop-in installation in existing 26 mm Edison/E27 European base sockets, and sturdy construction with UV-stabilized plastic lens and magnesium alloy housing.

Lighting designers and commercial institutions should sacrifice nothing in the pursuit of beautiful, energy-efficient light, and with the PAR38-12X2WF series, they will not need to compromise. These economical, high-quality floodlights are perfect in track lighting, security and emergency lights, general/architectural and landscape lighting, display case fixtures and cabinet lighting, signage and back lighting, aviation/aerospace lighting systems, industrial OEM equipment lighting, bio-medical and medical applications, museums or theatrical-effects lighting.

The maintenance-free LEDtronics PAR38 series comes with CE safety assurance and is RoHS certified—it adheres to strict European guidelines concerning the reduction of hazardous substances such as lead and mercury. Since it produces no harmful ultraviolet or infrared radiation, it reduces light pollution, and it is compatible with the international "Dark Skies" initiative. ■

Silicone Materials from Dow Corning Help Electronics Keep Their Cool

The growing use of high brightness and high power LEDs for different applications adds to the heat problem.

Dow Corning has developed a range of specialized thermally conductive materials and heat transfer materials to help manufacturers deal with the issue. These materials, in the form of adhesives, encapsulants, compounds, gels and pads, prolong the life of the electronic devices by protecting their sensitive circuits and components and enabling the excess heat to be carried off and dissipated.

Dow Corning offers a variety of silicones that function as heat transfer media, provide remarkable thermal conductivity, electrical insulation, moisture and UV resistance and protect the most sensitive electronic assemblies from corrosion, environmental contamination and external vibrations.

"While smaller and stream-lined models of home electronics look good and give users the performance they expect, the trend towards miniature gadgets presents some technical challenges", said Jeroen Bloemhard, Dow Corning's global executive director for Electronics. "People who have just paid hundreds of dollars for the latest MP3 player or laptop won't be happy if it fails just because it gets too hot. Our thermal materials mean home electronics manufacturers can continue to make these trendy, cool and sophisticated devices but also offer them peace of mind through durability, increased operating efficiency and reliability." ■

Bayer MaterialScience LLC: UV-stabilized Polycarbonate Resin for LED Applications

As part of its commitment to the growing LED lighting market, Bayer MaterialScience LLC has introduced a new grade of polycarbonate resin to its already extensive portfolio. The new grade, Makrolon® LED2243, was developed as a UV-stabilized, high-light transmission addition to Bayer MaterialScience's existing materials for LED applications.

Bayer MaterialScience already offers several grades of polycarbonate for the LED market that feature very high light transmission, high thermal stability, excellent stability under high LED flux and clear flame retardant properties. All of the grades offer specific characteristics ideal for a variety of LED applications.

These grades include:

- Makrolon LED2243 — The latest addition to Bayer MaterialScience's LED product portfolio was designed to resist UV light, and to offer superior clarity for optic and lens applications.
- Makrolon LED2045 — Highest light transmittance product, ideal for refractive optics, lenses, and light pipes and guides.
- Makrolon LED2245 — Similar to LED2045 — with slightly improved physical properties and lower melt flow index.
- Makrolon FR7087 — Believed to be the first clear polycarbonate that passes UL 94 5VA flame rating. Ideal for lenses, covers and optical components.

"Bayer MaterialScience is always developing new products for LED applications because we understand this growing market will continue to demand superior engineered materials," said Gerald DiBattista, Market Segment Leader, IT, Electrical/Electronics Polycarbonates, Bayer MaterialScience LLC. "Our goal is to provide OEMs with materials that

offer the highest clarity and quality for their applications and to be the plastics materials solution provider for the entire LED system, not just the premier optical materials supplier. We are pleased to be able to offer these specialty grades for the LED industry."

In addition to the optical LED grades listed above, Bayer MaterialScience offers products for LED enclosures and housings, products with excellent diffusion properties that can hide hot spots while transmitting high levels of light, and highly reflective products that can eliminate secondary process operations, according to DiBattista. "It does not matter if your application is for general illumination or a specialty lighting application, if you need an optic or a diffuser, Bayer MaterialScience has the products and the industry experience to make your LED project successful." ■

Silicone Reflector Material and Transparent Protective Film for HB LEDs

Shin-Etsu Chemical Co., Ltd. (Head Office: Tokyo, President Chihiro Kanagawa) announced that it has developed new silicone products used for high brightness LEDs. The new SWC Series is advanced silicone reflectors designed to greatly improve the brightness performance of LEDs. The new LPS-AF Series is protective film materials that are transparent and possess high heat resistance. These new materials will be used to improve the performance of high-brightness LEDs that are used for lighting products and for backlighting units in LCD TVs.

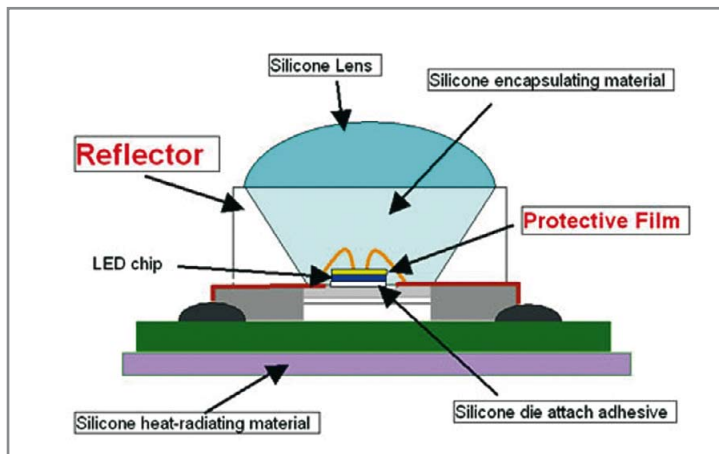

Typical LED package showing application options for the new silicone materials.

A reflector improves brightness by reflecting the light emitted by LEDs to the front of the display. Currently, polyphthalamide (PPA), a thermoplastic resin, has mainly been used for reflectors.

However, PPA has the big drawback. Because of its changes in color as a result of rising high temperatures of chip surfaces or in the presence of strong LED light, the light's reflection efficiency deteriorates and lowers the brightness of LEDs.

For this reason, a new reflector material, that has superior characteristics and which assures long-term quality for the use of lighting applications, was sought after. The advanced silicone reflector material for LED housing that Shin-Etsu has developed meets these requirements.

The SWC Series is a silicone-based material that has superior heat resistance and photo-thermal stability properties. It has characteristics that other reflector materials cannot offer. It reflects light with a high efficiency of more than 98%. Even though it is exposed for a long time under high-power short-wave-length light conditions, there is no degradation of the LED's light intensity. Furthermore, it can easily realize mass production and has flexible processability, making it possible to freely design packaging shapes.

The LPS-AF Series is a silicone-based transparent protective film that is superior in heat resistance and photo-thermal stability. By attachment to a LED chip's surface upon heating, it can easily encapsulate the LED. Furthermore, the film compounded with phosphors can easily and evenly change the blue light to white, which is emitted by a LED, and thus improve color uniformity.

Shin-Etsu Chemical has introduced many high-reliability advanced silicone products for LEDs such as silicone encapsulating materials (LPS-1000~5000 Series) to protect LED chips, which are superior in heat resistance and photo-thermal stability, silicone encapsulating materials modified with epoxy (LPS-7400), die bonding materials (LPS-8000 Series) with high-bonding strength and superior heat resistance, and silicone lenses.

Now Shin-Etsu's product line-up includes the newly developed SWC Series, advanced silicone reflectors and the LPS-AF Series, transparent protective film. As a comprehensive supplier of LED related materials, Shin-Etsu will continue to offer superior products that will match the market needs being more sophisticated.

As electronics devices contribute to lighten the environmental burdens of the world, the LED market is rapidly expanding in such applications as display devices for traffic lights, backlighting for LCD TVs, automotive headlights and interior room lighting.

Shin-Etsu foresees that the market size of reflector materials for LEDs will expand from the present ¥2.5 billion a year to ¥7.5 billion in 2013 and, accordingly, Shin-Etsu is actively promoting sample evaluations and setting up a production system at an early stage. ■

Brandenburg Gmbh and Beacon Concepts LLC Announce LucidShape 1.8

Beacon Concepts LLC and Brandenburg announce Release 1.8 of its LucidShape software with LucidFunGeo for lighting design and analysis. LucidShape reduces product development time by 30-50%.

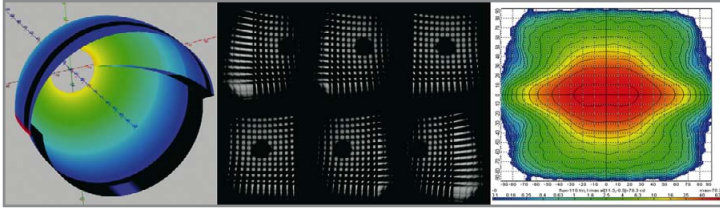

Simulated light distribution of LED optics.

The new LucidShape 1.8 release has many new features and improvements:

- Draft angle analysis
- Luminance camera
- IES roadway classifications
- Polar candela plot
- Dual filament macrofocal application
- Feature modeling/parameterization
- TC 4-45 and benchmarking

With the new draft angle display, the optical designer can immediately examine the draft on surfaces. This can dramatically speed optical design work flow, and ensures the design can be produced. If areas of the surface are black, they are below the required draft angle and must be corrected.

Capturing lit appearance images from an optical system can be very useful for analyzing the unit's performance and aesthetics. The luminance camera is a way to view the lit appearance of any optical component, using far less memory than previously necessary. In addition, the luminance camera can capture the lit appearance from all the objects in the scene, not just objects that have flow sensors.

Street luminaries can now be displayed in such a manner as to identify their IES classification (Type I, II, III and IV). In addition to the new street luminaire diagram, the street illumination application has also been improved with new road surface types and more scene controls.

LED collimating or diverging secondary optics (total internal reflection) are versatile components for SSL sources. They cover a large variety of LED applications, are cost efficient and effective. LucidShape offers you a powerful application for the design of these optical components. Not only rotational (spherical) optics are designable, users can also process elliptical optics or create any specialized shape by defining all four curves of the profile. An option for creating cone apertures for the direct coupling into optical fibers is also part of this feature. ■

Announcements

LED FORUM MOSCOW 2009: Register Now!

Companies and experts interested in the Eastern European and Russian LED markets should not miss the 3rd LED FORUM MOSCOW, which takes place in Moscow on November 11th and November 12th, 2009. The plenary session features Russian market leaders presenting their LED investment plans. Workshop sessions on the second day are dedicated to:

- A) Indoor / Outdoor LED Lighting (Sponsor: OSRAM Opto Semiconductors)
- B) Store Lighting Using LEDs (Sponsor: iGuzzini)
- C) Lighting Control Systems for Complex LED Applications

The LED FORUM MOSCOW is the most important conference on LED technologies in Eastern Europe and Russia. It is the ideal platform for international companies who want to analyse the Russian market. At LED FORUM MOSCOW LED experts can get in touch with existing business partners and meet new clients / distributors.

The LED FORUM MOSCOW is one of the exciting events on the INTERLIGHT MOSCOW, Russia's leading trade fair for lighting, light technologies and smart building technologies.

Further information:

www.ledforum-moscow.com
www.interlight-moscow.com





Edison Opto Corporation is a Taipei, Taiwan based global leading high power LED manufacturer. The company offers a comprehensive product line ranging from 1 Watt to 100 Watt, single-chip to multi-chip, and high flux to high CRI. The diversified product offering will answer to even the most challenging fixture designs.

New!

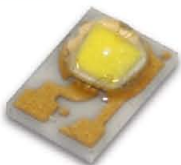

Edixeon® Federal Series

Uniform white light with MAPLE uniform coating technique

Mixing luminescence phosphor with silicone and dispensing it on a blue light emitting chip is a common LED package method in producing white light. The quality of white light depends heavily on the uniformity of phosphor on the blue die. Often times, when coupling secondary lens on white LED, it will reveal yellow circling. Such yellowing greatly shadows the quality of white light.

Application

Electrical Considerations of LED Bulbs

> Siegfried Luger, Arno Grabher-Meyer and Lukas Gorbach, LED professional

Governments all over the world regulated the future use of the inefficient incandescent lamps. For example, the member states of the European Union agreed to a phasing out of incandescent lamps by 2012. The initial European-wide ban applies the first step to "non-directional" light bulbs. The first types of bulbs to be banned are frosted (non-clear) bulbs and clear bulbs over 100 W, which will be phased out completely by September 2009. The power limit will be moved down to lower wattages, and the efficiency levels raised by the end of 2012.

The replacement of 3.5 billion incandescent lamps installed throughout Europe with more-efficient lighting technologies, such as LEDs will lead to a relevant reduction in the power consumed by lighting systems.

The efficiency values and the light quality of LED bulbs are the focal point nowadays. Nevertheless, the behavior of the LED bulb technology in respect to the electrical parameters is of interest as well. LED professional has tested seven LED bulbs from four manufactures to get an inside view and reports the surprising results in this article.

Testing Conditions

Most recently produced LED bulbs from ATG Electronics, Line Lite, Exceed and Lemnis Lighting were analyzed (see Table 1). The first test stage covered the electrical parameter measurements of the mains such as input power, input current, power factor, current and voltage distortions. In the second test stage the LED bulbs were disassembled to extract the electrical circuit diagrams, and to study the mechanical designs. All tests were performed under room temperature and the devices were powered through a 500 VA electronic power amplifier simulating stable mains conditions.

Manufacturer	Brand	Nominal Luminous Flux
ATG Electronics	eLucent	230 lm
		760 lm
		110 lm
Line Lite	BriLux ECOLED	250 lm
		300 lm
Exceed	LED Spotlight	280 lm
Lemnis Lighting	Pharox	330 lm

Table 1: List of manufacturers and product brands tested in electrical parameters.



Figure 1: Example of a tested product (BriLux ECOLED from Line Lite).

Measurement Results: Power Analysis

The power factors of the measured LED Bulbs showed poor values in general, ranging from 0.32 to 0.48 (see Figure 2). The low power factor values are the reasons why only 32-48% of the apparent mains power is transmitted to the LEDs as active power (see Figure 3). Nowadays, international standards claim for power factor correction circuits only for power values above 25 W. Nevertheless the reactive power has to be transferred from the power plants to the loads, ending up in unnecessary power demands and increased transmission losses.

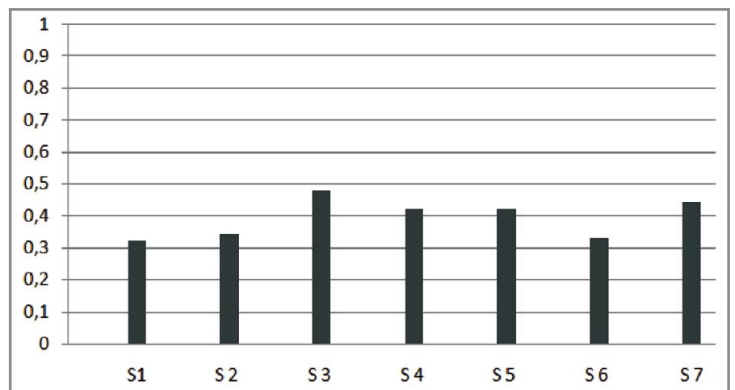

Figure 2: Power Factor values of the tested LED bulbs. X-axis: S1 to S7 showing numbers of the tested samples. Y-axis: power factor from 0 to 1.

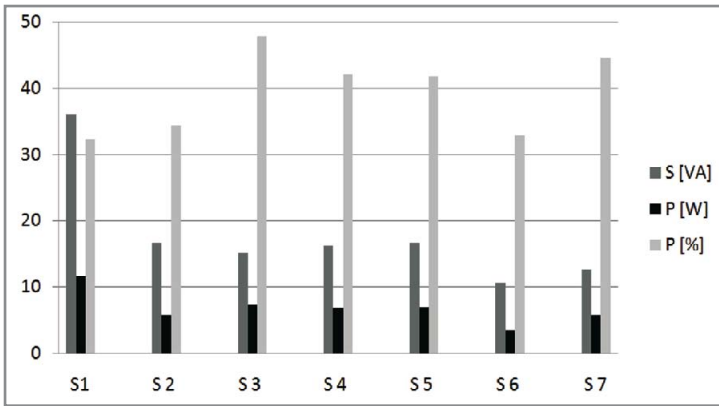

Figure 3: Mains power values of the tested LED bulbs. X-axis: S1 to S7 showing numbers of the tested samples. Y-axis: Apparent power level S in VA (dark grey bars), active power level in W (black bars) and the relation of the active power to the apparent power in percentage (light grey bars).

Load Reduction Potential of Power Plants in the European Community:

Today, 3.5 billion incandescent lamps are installed in the European Community [1]. Two billion lamps are replaced each year with an intermediate lifetime of about 1,000 hours [2]. These figures imply that in average two billion lamps must be switched on for three hours every day. Due to the European time zones, it is possible that these lamps can be switched on at the same time. With an average lamp power level of 40 W (400 lm/bulb), a peak power demand calculation shows a result of 80 GW. The overall energy consumption per year can be calculated by multiplying 40 W by the intermediate lifetime by the number of replaced lamps per year, $40 \times 1,000 \times 2,000,000,000 = 80 \text{ TWh/a}$.

The replacement of the installed incandescent lamps with 8 W LED bulbs (50lm/W, warm-white) and similar lumens output values as the incandescent lamps, would cut down the energy consumption per year to 16 TWh/a. In other words, an energy saving of 64 TWh/a could be reached, an amount that needs over 50 large 1,200 MW light water reactors. But what does this mean for the peak power load of the power plants?

The measurements showed that most of the recent LED bulbs have a relatively poor power factor resulting in a high apparent power. Hence an apparent power of 20 VA has to be calculated, in the worst case even 25 VA. As a result the peak power load is between 40 GW and 50 GW. This means a reduction between 40 - 50%, setting free a capacity of up to 25 of the named light-water reactors for other tasks. At first glance, that does not look so bad, but this is just 50% of what one would expect regarding the energy saving calculations. The reason is that only 35% of the apparent power is active power.

A replacement by LED bulbs with high-power factor values between 0.9 and 1.0 would reduce the peak power demand by an additional 50 - 65%, to 16-18 GW, hence set free peak power capacity of up to 64 GW compared to incandescent lamps. Improving the power factor to 0.9-1.0 finally is the key factor to freeing up the capacities at existing power plants. It has to be recognized that most compact fluorescent lamps suffer from the same problem - at least as much as LED bulbs do. On the other hand, it has to be mentioned that there are also products available that offer power factor values of 0.85 or even more.

	Apparent Power Demand	Apparent Power Reduction	1200 MW Light Water Reactors
Incandescent lamps	80 GW		67
After replacement with LED bulbs (poor power factor)	40-50 GW	40-50%	33-40
After replacement with LED bulbs (power factors > 0,9)	16-18 GW	55-65% (>77,5 % overall)	13-17

Table 2: Peak power demands for light bulbs in Europe nowadays and after replacement with LED bulbs.

Measurement Results: Mains Current Distortions

The effects of the poor power factors can also be obtained at the mains input currents. Figure 4 and Figure 5 show very typical signals of the mains input currents for LED bulbs without power factor correction means. Near the input mains voltage maximum high input currents flow to charge up the internal capacitors of the LED bulbs and to supply the LEDs. The phase angle of the current flow is small and reaches only values of 10-15°. In an electrical installation, the high currents will occur at nearly the same time and will lead to a distortion of the mains voltage, generating additional wire losses. The di/dt current values of such LED bulbs vary in a wide range between 1.0 mA/μs to 253 mA/μs.

	I _{MAX} [mA]	t _{RISE} [μs]	di/dt [mA/μs]
S1	936	3.0	253
S2	358	2.2	1.3
S3	411	2.0	2.1
S4	320	2.1	1.2
S5	338	2.2	1.3
S6	270	2.1	1.0
S7	305	1.0	2.5

Table 3: Maximum mains currents, related rise-times and resulting di/dt values are shown.

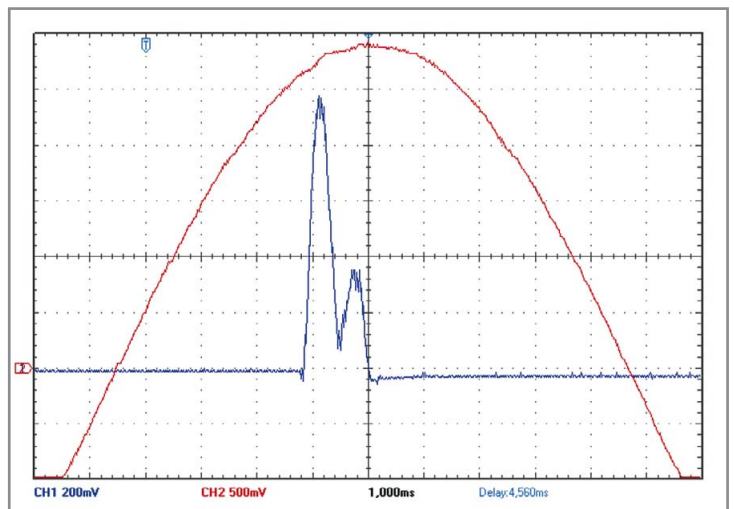

Figure 4: Typical mains current of an LED bulb. X-axis: 1ms/div. Y-axis: Mains voltage with 50V/div (red curve) and mains current with 100 mA/div (blue curve).

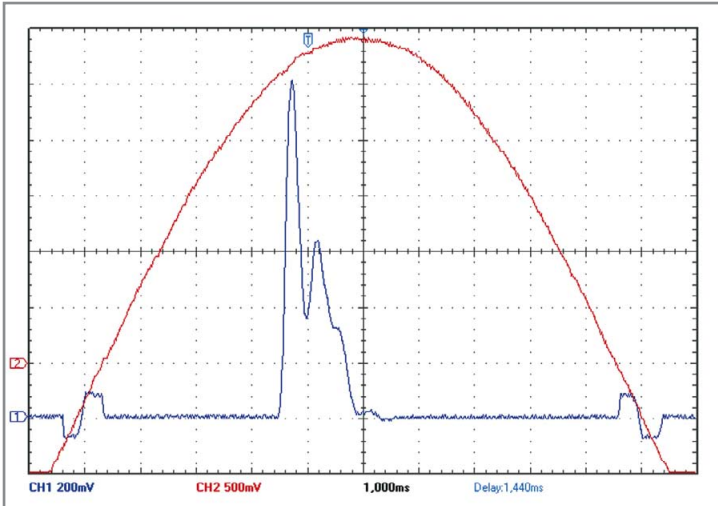

Figure 5: Typical mains current of an LED bulb. X-axis: 1ms/div. Y-axis: Mains voltage with 50V/div (red curve) and mains current with 50 mA/div (blue curve).

Figure 6 shows the mains current signal of a tested product. The phase angle of the mains current is much higher due to the usage of a passive valley fill circuitry. The switching frequency (some kHz) of the internal circuit can be measured almost unfiltered at the LED bulb mains terminals.

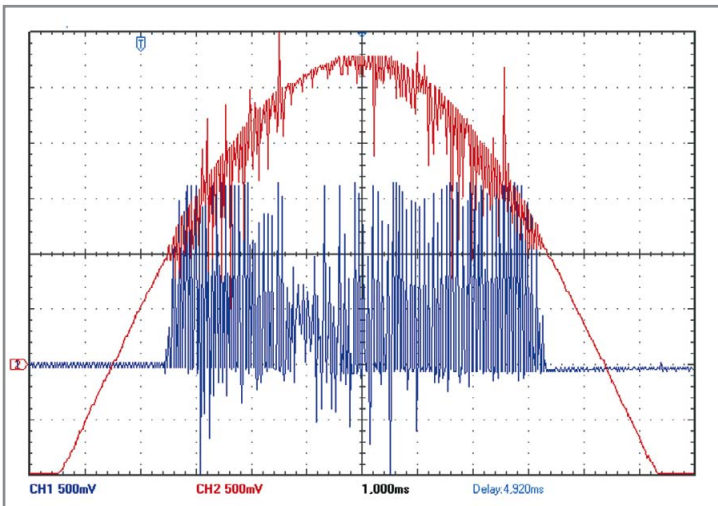

Figure 6: Mains current of an LED bulb showing current and voltage distortions. X-axis: 1ms/div. Y-axis: Mains voltage with 50V/div (red curve) and mains current with 200 mA/div (blue curve).

Circuit Diagrams

Typical circuit diagrams of LED bulbs are shown in Figure 7 and Figure 8. The circuit in Figure 7 uses a passive valley fill circuit in the mains input part built up with the components C1, C2, and D1-D3. This topology connects the C1 and C2 capacitor in series for the charging phase while the capacitors C1 and C2 are connected in parallel through the diodes D1 and D3 during the discharging phase. This enlarges the phase angle of the mains current flow and improves the power factor. This circuit corresponds to the signals showing in Figure 6. The high-frequency switching of the LEDs through the MOSFET Q1 leads to a high distortion of the input current and voltage. The LED strings are connected in parallel to C3. There is no galvanic isolation of the LED strings from the mains input voltage. The actual product uses only the coating material of the metal core substrate to isolate the outer parts (metal housing) from the mains voltage.

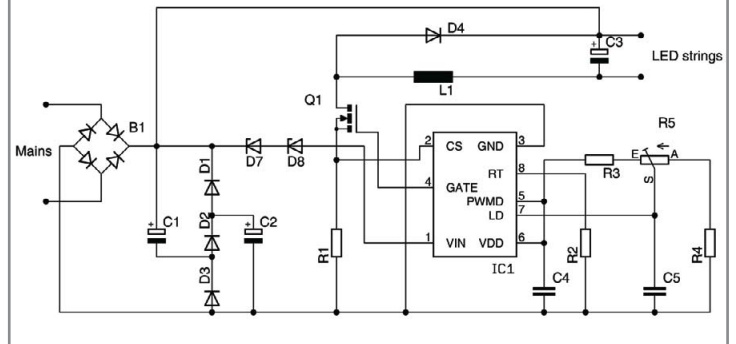
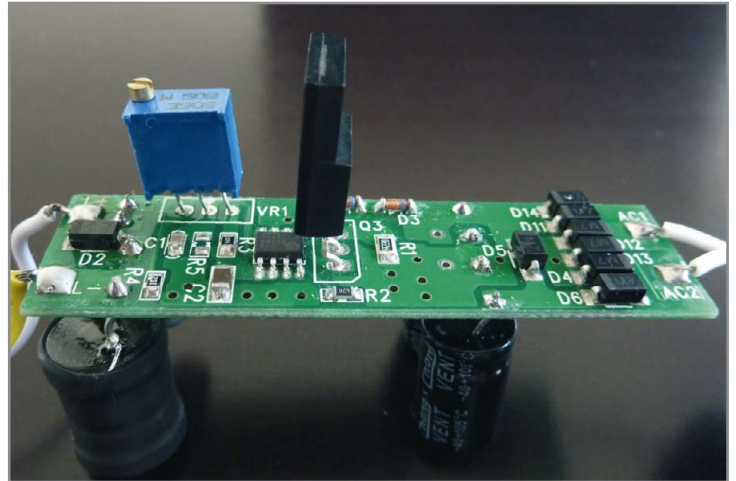

Figure 7: LED bulb with a non-isolated driving and a passive valley fill circuit.

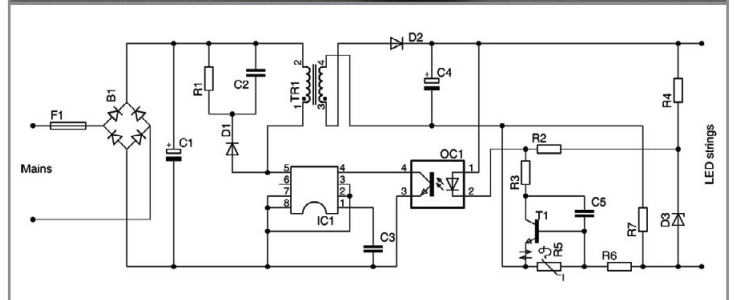
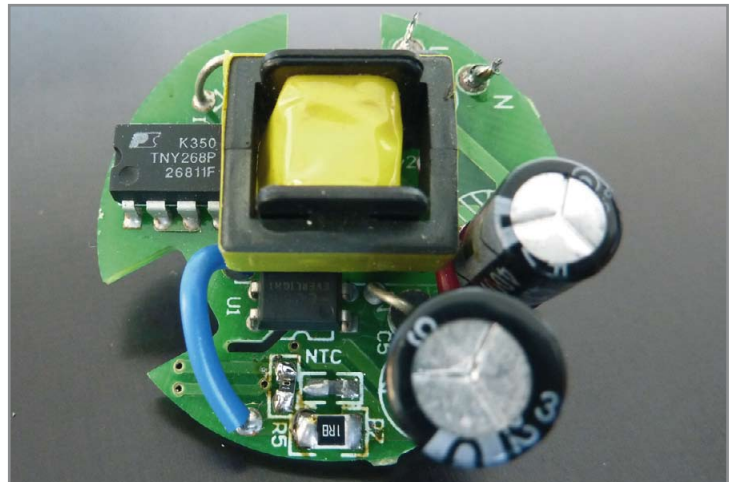

Figure 8: LED bulb with an isolated driving and feedback circuit.

Figure 8 shows an improved circuit with a galvanic isolation between LED output and mains input circuit parts. Since there is no power factor correction means, the power factor is still poor and the phase angle of the current flow is low. An optocoupler (OC1) is used to close the feedback loop to guarantee the galvanic isolation.

Conclusions

Incandescent lamps are banned. The market is ready for new technologies such as LEDs. LED professional has tested seven actual LED bulb products regarding the mains parameters and the electrical circuitries to check the quality of their electrical designs.

Firstly, the security issue seems to be most important. One product uses the metal core substrate coating material to isolate the housing from the mains. Regardless of the coating specification, this seems to be insecure, e.g. in the case of a material defect or a production failure. Users are unable to recognize this security risk. Secondly, the tested products show poor power factor values. Although they are in-line with the regulations, the expectation that power plant capacities could be set free for other tasks will not be fulfilled. Thirdly, high-frequency distortions below 10 kHz could be obtained. Standard EMI tests ignore this frequency range, but in practice unwanted behaviors of installed electronic systems could occur. Lastly, the LED itself does not define the lifetime of the products. LED bulbs, e.g. with optocouplers, could get strong lifetime degradations especially at higher operating temperatures [3], which were observed in all the products.

The market entrance for new technologies such as LED bulbs is always critical, because the consumers needs confidence in these new products. This confidence can be built up with high quality and secure products where all manufacturers will gain from it. Galvanic isolated outputs, power factor values close to 1, no high-frequency disturbances at the LED bulb terminals, and a careful selection of lifetime critical components such as optocouplers are quality aspects for the design of LED bulbs. Such products will win the market race in the long run. The cost issues are important as well, but more so the potentials for further innovations. ■

Fact Box

Luger Research e.U., founded in Austria 2001, is publisher of LED professional. Now, Luger Research - the institute for innovation and technology - established a lighting laboratory (LED professional Laboratory - LpL) to support the lighting industry with investigations about the design and quality of LED products. Reports of the LED professional Laboratory (LpL) will be published through the media channels of LED professional. Furthermore Luger Research offers direct support in the design and application of LED products.

References

- [1] Karel Smrcka, *EU ban on incandescent lamps to help consumers, the climate*, *Engineering News* January 30, 2010 [<http://www.engineeringnews.co.za/article/eu-ban-on-incandescent-lamps-to-help-consumers-the-climate-2009-01-30>]
- [2] <http://www.contexo.net/wiki/index.php?title=Energiesparen>
- [3] Arno Grabher-Meyer, *Optocouplers – A Critical Design Element in LED Bulbs*, *LED professional Review* 15

Optocouplers – A Critical Design Element in LED Bulbs

> Arno Grabher-Meyer, LED professional

Security issues are very important for the LED bulb electrical design. Since input to output isolation is the preferable solution, e.g. Flyback converters are an appropriate choice. One drawback of an isolated design is the feedback loop that needs to be electrically isolated too, which leads to extra efforts in the form of additional components, usually an optocoupler.

There are lots of manufacturers and products on the market and it is a challenge to make the right choice and a proper design. The products differ in price and quality in a broad range. What are the most important criteria to watch out for?

Datasheets show numerous graphs. Most of these graphs are important for a proper adjustment of the operating point and range. That may be sufficient for controlled ambient conditions. But for LED bulbs it cannot be assumed that they are operated in a narrow temperature range. On the contrary, it has to be taken into account that the bulbs can be mounted in different orientations and enclosures as well as under different ambient temperatures, which causes great variations of the working conditions. The relative current over the ambient temperature has a strong nonlinear behaviour and leads to very different light output. Another temperature dependent parameter is the collector dark currents. Even if the dark currents of modern optocouplers are very low – between some pA and some μ A – they are not negligible. Such problems have to be taken into account very carefully when designing a feedback loop circuit for an LED bulb. But there are even greater issues.

LEDs are predestined for a long lifetime and most products are rated for 35,000 up to 50,000 hours. The degradation over lifetime of all components has to be matched with these lifetime expectations for the LEDs. Since optocouplers are also based on LED technology, one could argue that both LEDs will degrade almost in parallel and that could lead to compensating effects like constant light output due to an increased driver current. That may work, but the thermal stress would increase and could affect the lifetime dramatically. It also does not necessarily mean that optocoupler LEDs have the same lifetime as high quality LEDs.

Basically an optocoupler consists of an LED, a photodiode or phototransistor, and a transparent isolation in-between. Each of these components can be made of different quality and show a different aging behaviour. This behaviour is strongly dependent on the load current of the LED, the junction temperature (or component temperature), and the material and manufacturing dependent parameters.

In a "General Description" document [1] from Vishay Semiconductors, it is shown that the current transfer ratio of a high quality product degrades by 5% over 100,000 hours at 60 mA and a junction temperature

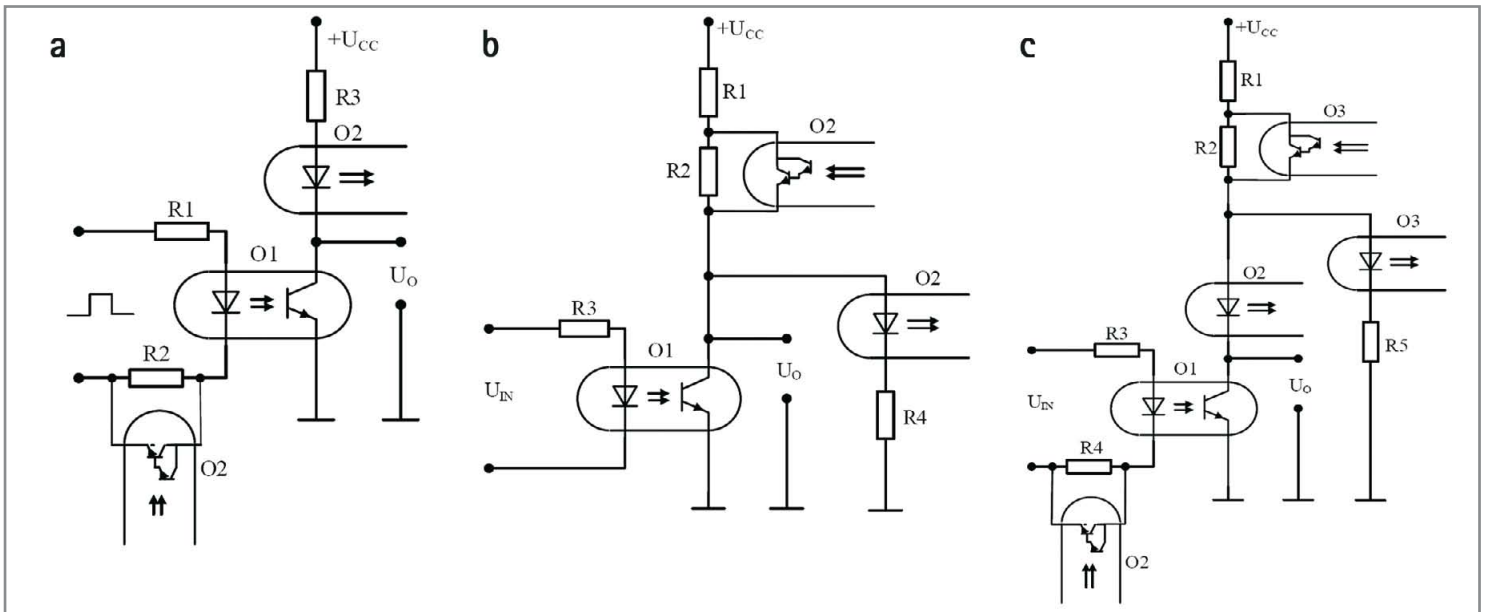

Figure 1: Compensation circuits to reduce degradation effects (from left to right for LED, phototransistors and both).

of 60° C, but by 30% at a junction temperature of 125° C. Such degradation could be caused by each component of the optocoupler; the LED or the photodetector, or loss of transparency of the isolating resin, or the sum of all these factors.

In a study on the "Reliability of Optoelectronic Elements" from Ivan Stanchev Kolev and Tsanko Vladimirov Karadzhov [2] failure frequency in dependency of the previously mentioned factors was researched and different design instructions were proposed:

- Operation of LEDs at low temperature, if necessary cooling of LEDs
- Operation with a low LED current and a low mark-to-space ratio
- Usage of optocouplers with a high CTR (K_i)
- High resistive output load
- Usage of negative optical feedback
- Operation with the LED current below 50% of the datasheet value
- Usage of heteroLEDs

In addition, the authors proposed compensation circuits for the LED, the phototransistor circuit or both (Figure 1).

J. Ben Hadj Slama et al. [3] point out that after an accelerated thermal aging with a T_j of 105° C photodetector aging was negligible, whereas LED degradation, especially for lower currents, was significant. All other performed tests indicate also that LED degradation is the most important issue. It was also shown, that higher currents have more influence than higher ambient temperatures if T_j is identical for both situations. Based on these results the team developed a model that fits quite well for a degradation prediction above 200 hours.

Agilent offers information on aging and reliability of optocouplers in a designer guideline [4]. The aging was performed at an ambient temperature of 125° C with 25 mA and 100% duty cycle. To extend lifetime Agilent recommends lowering I_F clearly below the stress current of 25 mA, e.g. down to 5 mA. In addition duty cycles below 100% will

help to reduce degradation as well as lowering ambient temperatures. All these provisions result in a lower junction temperature, which is seen to be the main reason for degradation. AlGaAs LEDs show lower degradation over time than GaAsP LEDs based optocouplers and, hence are the better choice.

Motorola also analyzed lifetime behaviour of optocouplers with very similar results to Agilent [5]. At a moderate ambient temperature of 40°C the absolute difference between I_F of 1 mA and 50 mA was relatively small with a degradation of a few percent after 50,000 hours. At an ambient temperature of 70°C for both currents, degradation was much higher, but degradation for $I_F = 1$ mA was still acceptable with 6% after 50,000 hours. Nevertheless, for batch variations that would be typically seen in a large volume production they propose a 6-sigma correction, which leads to a degradation limit of 25% instead of 6%.

All studies show strong dependencies of degradation from ambient temperature and the LED forward current I_F . The forward current can be controlled by the design where the ambient temperature is a given parameter. In LED bulb applications the optocouplers are integrated within the heat sinks which can reach temperatures of 60–70°C at an ambient temperature of 25°C, and the optocouplers are exposed to ambient temperatures of 70°C. Compensation circuits as proposed from Ivan Stanchev Kolev, et al. could help to prevent damage. As an alternative to optocouplers, the auxiliary windings of the Flyback transformers could be used for feedback issues, or new driver ICs could allow for designs with primary side feedback systems. ■

References:

- [1] Vishay, Document Number: 80059, Rev. 1.6, 08-Jan-08, optocoupler.answers@vishay.com, www.vishay.com
- [2] RELIABILITY OF OPTOELECTRONIC ELEMENTS. CIRCUIT SOLUTIONS FOR ITS IMPROVEMENT, Ivan Stanchev Kolev, Tsanko Vladimirov Karadzhov, Department of Electronics, Technical University – Gabrovo, Bulgaria, ELECTRONICS' 2005
- [3] Study and Modelling of Optocouplers Ageing, J. Ben Hadj Slama, H. Helali, A. Lahyani, K. Louati, P. Venet and G. Rojat, J. Automation & System Engineering 2008
- [4] Agilent Optocoupler Designer's Guide, www.agilent.com/semiconductors, 2002
- [5] Motorola Optoelectronics Device Data, DL118/D – Rev. 5, 1998

A vision of light.

LED Lighting. Create it. Change it. Control it.



Feast your eyes on the world's first microcontroller with integrated constant current driver for large-scale high brightness LED systems. Or experience LED driving and power factor correction from a single ultra low power microcontroller.

Two families supported by graphical tools that let you create complex lighting sequences, colour mixes, fine-step dimming and DMX512 or DALI communication; it only takes three simple steps and no microcontroller experience.

Backed up by the first-class support you expect from one of the world's top microcontroller suppliers. Not to mention low-voltage MOSFETs, optocouplers, LED driver ICs, ZigBee™, Powerline devices and much more. Unique solutions from NEC Electronics, created to help you create yours.

www.eu.necel.com/lighting

Case Study – LED Solution Offers Advantages for Henkel Waste Water Plant

> Gordon Routledge, Dialight, Boris Viner, Consultant to Dialight

Many articles on LED lighting technology compare its raw performance with the traditional technology it is attempting to emulate. While this approach may work for many general lighting applications, such as retrofit bulbs, it often fails to explore the full benefits and possibilities of LEDs which can yield significant energy and operational savings even compared to existing fixtures which at first seem very efficient.

An emerging area in which LED technology can deliver a compelling value proposition is the illumination of industrial facilities, and in particular those outdoors often found in petrochemical and associated downstream industries. The requirements for lighting such facilities can be more onerous than general lighting applications, due to the presence of complex structures, equipment and pipe work. The lack of walls and roof space also adds to the design challenge, as very few reflecting surfaces exist and there are often limited mounting surfaces on the structure. In many schemes a broad brush approach has been used, with lighting design based upon spacing tables with little account taken of the exact dynamics of a particular installation. This tends to lead to over lighting, which is wasteful in terms of energy, but also creates the potential for severe light pollution.

The lighting of industrial plants is often defined by national and international codes of practice, which sets minimum light, uniformity, glare and colour performance requirements related to the task being undertaken within a particular part of a facility. In Europe this is covered by EN12464-2 which also includes reference to the limitation of light pollution in relation to a plant's location within the wider environment.

The case study being presented here comprises the redesign of an industrial effluent plant in Puerto Rico belonging to Henkel, best known as the manufacturer of Loctite. This plant produces adhesives and sealants for serving the transportation, electronics, aerospace, metal, durable goods, consumer goods, maintenance and repair, and packaging industries. The main aim in looking for replacement lighting has been to reduce the total energy consumption and improve lighting efficiency.

A waste water treatment plant of this type is classed as a hazardous location, meaning that under certain operating conditions explosive gas could exist, with the potential for ignition and subsequent explosion resulting, for example, from the accidental creation of electrical sparks. This situation means that equipment used in the area must be approved for such an environment.

The layout of the plant (Figure 1) comprises a number of waste water treatment tanks, around which is an access platform used for maintenance and operation of the facility. The existing lighting scheme in this area uses a total of 16 high pressure sodium (HPS) lighting fixtures, each with a rated power of 295 Watts. It must be remembered that the stated lamp wattage, 250 Watts in this case, does not include the control gear losses which mean the real circuit wattage can be around 20% higher depending upon the control gear type employed within the fixture.

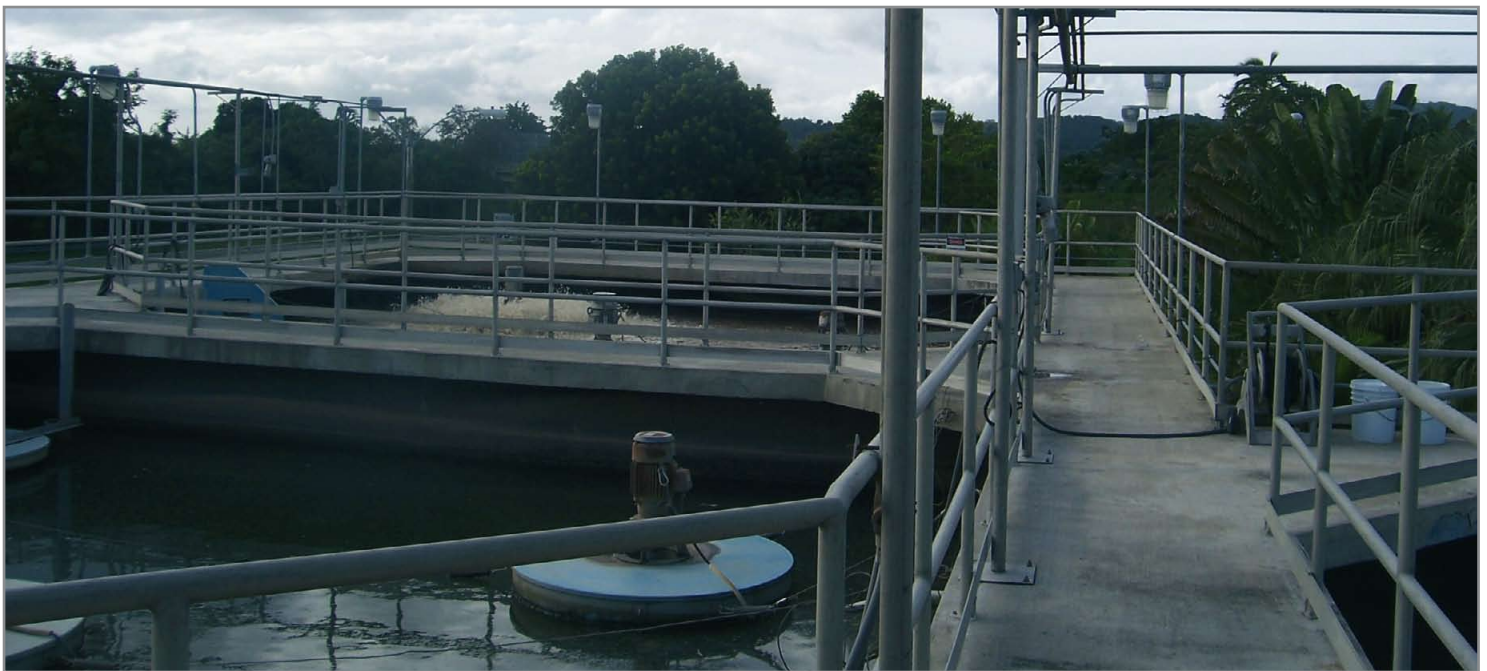

Figure 1: The original layout of the plant.

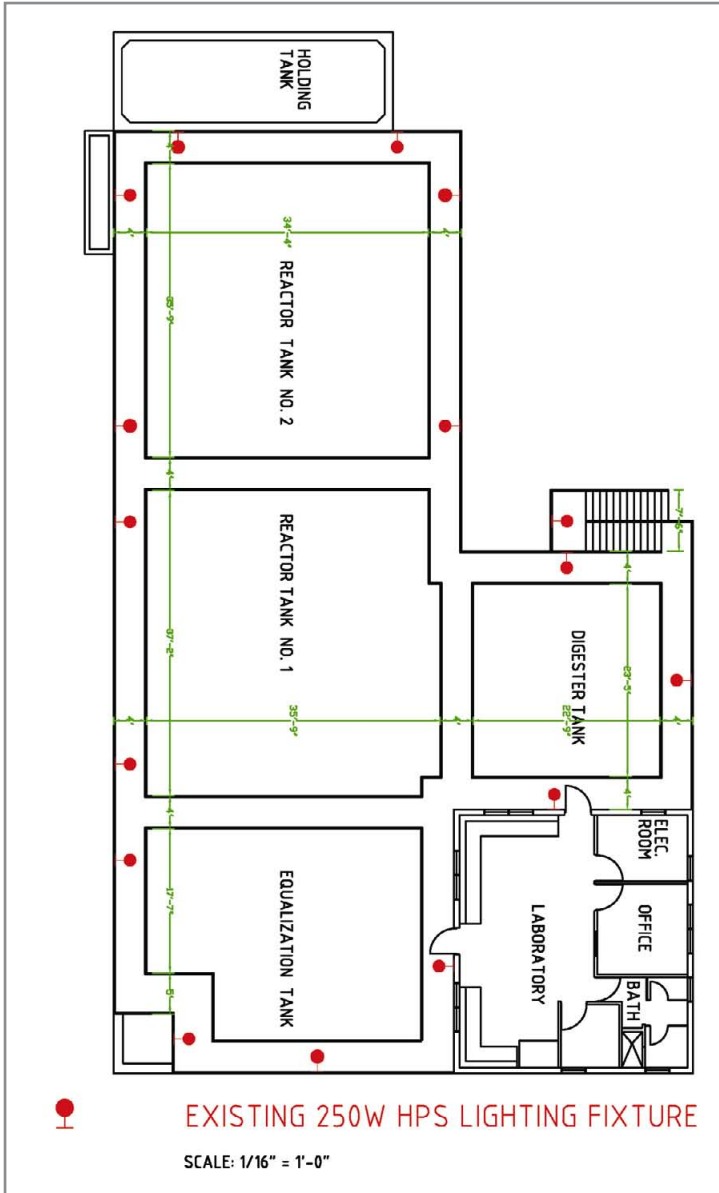

Figure 2: The illumination layout of the plant using HPS lighting fixtures.



Figure 3: The existing type of lighting fixture used on the installation. This type of fixture is used extensively in the North American market and has been in production for many years.

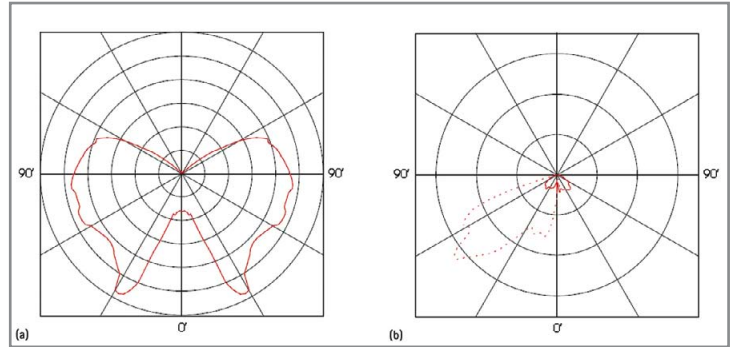

Figure 4: A comparison of the polar plots of the HPS fixture (a) and the SafeSite fixture (b).

Figure 4a is a polar plot for this HPS fixture which gives an indication of the direction in which light is emitted from the fixture, in this case symmetrically around 360 degrees. The initial lumen output from the HPS lamp is around 20,000 lumens, which gives an efficacy of 68 lumens per circuit watt. A closer look at the polar plot also shows light being emitted above 90 degrees – this is wasted light and will probably result in light pollution problems.

Figure 4b shows the distribution of the light output from the SafeSite LED fixture, which is radically different – the light is directed in a forward direction, with no light spill above 90 degrees. It has a rated wattage of 100 watts, which produces a lumen output of 4,300 lumens, resulting in an efficacy of 43 lumens per watt. Upon first inspection this seems vastly inferior to the existing HPS fixture, but the wider application needs to be carefully understood to validate the complete performance criteria.

	HPS	Dialight SafeSite
Circuit watts (W)	296	100
Output lumens (lm)	20,000	4,300
Efficacy (lm/W)	68	43
Colour Rendering (Ra)	20	70

Table 1: A brief summary comparison between the two fixture types.



Figure 5: The SafeSite® is a new generation of industrial lighting fixture, which uses LED technology.

Redesign of the lighting scheme

The broad brush approach to lighting design can be avoided by using one of the many lighting design software tools, such as Relux [1], that are commonly available. Manufacturers' photometric data, sometimes referred to as IES files, can easily be imported and direct comparisons made between different types of fixtures. Using software tools allows the lighting layout to be optimised to achieve good lighting uniformity with the minimum number of lighting fixtures.

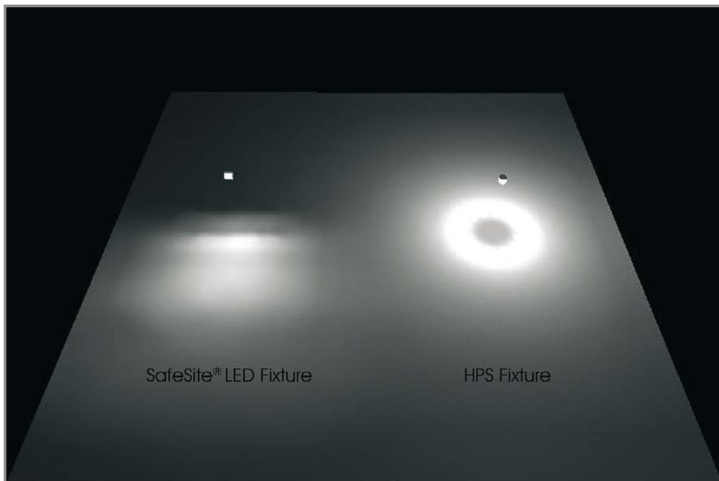

Figure 6: Comparison between the HPS fixture and the SafeSite using a lighting design software tool.

A comparison between the HPS fixture and the SafeSite using a lighting design software tool (Figure 6) helps to explain the differences shown in the polar diagrams discussed earlier. Looking at the comparison the HPS fixture has a much wider distribution than the SafeSite fixture, but it's essential to consider just where the light is actually required within a target area. In this application the target area is the access walkway and the effluent tanks. The HPS fixture could be better utilised by being mounted centrally, but this would mean having to position above the tanks, which would give maintenance issues. Again this highlights the difficulties of lighting industrial installations where light going beyond the target area is essentially wasted. Also upon first inspection the HPS fixture appears to be much brighter, but this can cause other problems. The lighting objective is not just to achieve the correct light level, but also good uniformity of light across the illuminated surface. The amount of light emitted at high angles can also cause glare. The LED fixture has an altogether different forward facing distribution, with good uniformity of light across the beam.

The result of the lighting redesign is a reduction in the total number of lighting fixtures from 16 units down to 12 SafeSite units (Figure 7). Combined with the much lower power rating, this means a reduction in total power from 4736 watts to just 1200 watts - around 75% reduction.

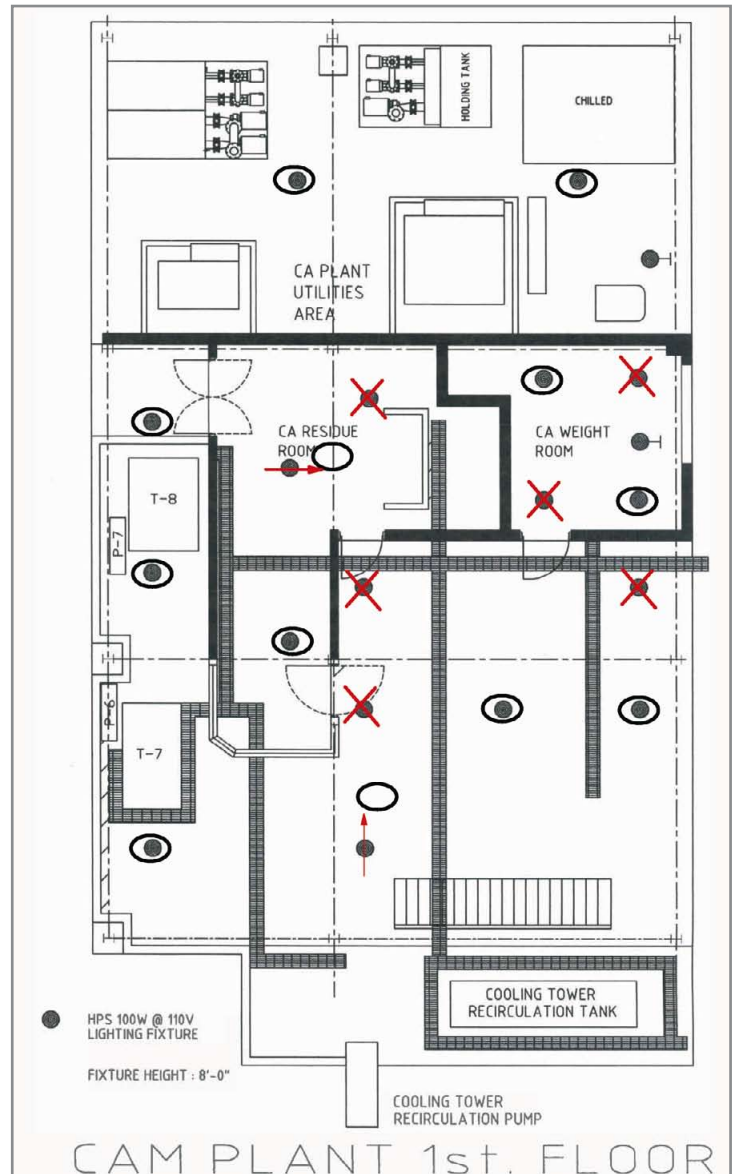

Figure 7: Number and location of fixtures required to achieve the correct light levels specified.

Although it might be the primary aim in this application, power reduction is not the only benefit of switching to LED technology. HPS light sources have an inherent orange light output, expressed as a low colour rendering (Ra 20). This makes it difficult to distinguish between colours, so in industrial applications, such as this, personnel can be forced to carry flashlights in order to successfully perform basic maintenance functions such as identifying correct valves or identifying cable colours in electrical repair situations. The LED light source has a very crisp white light output (Ra 70) that reduces the need for flash lights and improves the working environment. Figure 8, "Before and After", shows the comparison between the HPS and the LED installation in terms of lighting quality.

References:

[1] www.relux.ch



Figure 8: "Before and After" - the same scene with HPS lighting on the left and LED lighting on the right.

The LED fixture has a guaranteed minimum working life of five years, with the light source exceeding 50,000 hours of continued operation; this is at least double what can be expected from the HPS source. The life of LEDs does not depend upon the number of switching cycles, so further operational benefits and energy savings can be realised by use of occupancy sensing around the installation. This would be difficult to achieve with HPS as their lamp life is shortened by repeated switching and the lamps have a significant warm up time before they provide useful light. In contrast LEDs produce 100% output from the instant they switch on.

The final major advantage is the reduction of light pollution. The fixture has a sharp cut off optical system which produces no upwardly directed light and minimal light spill outside of the target application area.

For Henkel the outcome of this installation was far better than anticipated as, in addition to achieving their objectives of cutting power consumption and creating a more efficient lighting system, the quality of illumination was vastly improved while overall safety also saw significant improvement. Henkel maintenance manager Edgar Agront commented, "The LED lighting looks brighter and more natural. A lot less yellow, so people thought that more light had been added when actually we've reduced the number of fixtures by a quarter."

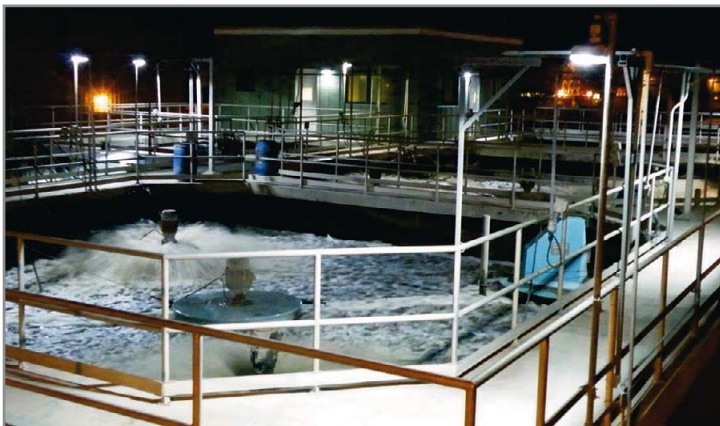

Figure 9: View of the plant with the final installation.



Conclusion

LED lighting technology can create a compelling value proposition in the illumination of industrial installations, but fully understanding the lighting requirements and application as a complete system is essential in order to achieve significant savings in energy and improved efficiency from the lower number of fixtures ultimately required. ■

Silicone Lens

To increase your product's dependability

High Light Transparency
High Thermal Stability

Injection Mold Lens



Over Mold Lens

Fujipoly.DSEM Co Ltd

Website: www.fujipolydsem.com

Enquiry: sales@fujipolydsem.com



Technology

High Efficiency Reflective Mirror Type LED

> Shigeru Yamazaki, Technical Adviser, Alpha-One Electronics Ltd

The emitting efficiency of LED has been improved by developing the new materials and the structure and the invention of the production process since 1963 when the Lighting Emitting Diode was put to practical use by The Monsanto Company, a United States-based multinational agricultural biotechnology corporation.

At the first stage, the LED was used only for the application such as an indicator that required just a little intensity like 10 mcd. However, the introduction of the fore-element materials like Indium gallium nitride (InGaN) and Aluminium gallium indium phosphide (AlGaInP) enabled LED to emit with higher intensity. As a result, the LED with visible rays was widely used in lighting and illumination like outside and indoor displays and the traffic signals, and as for the infrared LED, it became the key device as a light source for the surveillance system and image processing. Today, LED is in the limelight as the various light sources in the next generations, and the further improvement of its efficiency would be highly expected.

As mentioned above, though the materials have been developed in many ways in order to improve the efficiency of LED, there have been quite a few reports that the efficiency of the light intensity was improved by its packaging technology. In fact, the most of the LED in the market are the plastic molded type, and the production process and its structure of the package have not been changed so much since LED was introduced and started to be used in various fields. Of course, the efforts to increase the intensity have been done by putting the reflective flame (hone) at the sides of emitting element and by improving the lens in front of the emitting surface, but they were just the method based on the principal to improve the luminosity intensity by putting the lens in front of the emitting element, and so, it cannot be considered as 'the dramatic improvement of the LED structure'.

The Weak Points of the Normal LED

The plastic molded type LED

The light from the emitting element irradiates to the outside through the lens at the top of the package. In this structure, the emitting light from all sides of the element does not incident onto the top of the package (lens). That is, all the lights from the element never irradiates to the outside because they are not controlled.

In order to condense rays of light from the side of emitting element efficiently, the reflective flame called 'Hone', which is combined the emitting element and the leading wire, is utilized. However, since such

'Hone' was produced with Emboss process, the condition of its surface is far from the function of the optical mirror. (Figure 1)

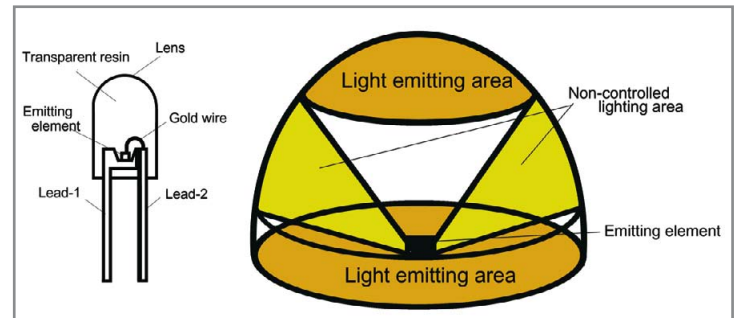

Figure 1: Structure of molded LED (left) and effective emitting light of molded type LED (right).

Surface mount type LED

The basic structure of the surface mount type LED is shown in Figure 2. The emitting element is installed on the ceramic substrate, and the transparent resin as a function of lens is mounted on it. Since it is very compact, and the light distribution is wide and well-balanced, it is suitable for the backlight of LCD. However, the light intensity is much lower than the one of the plastic molded type LED, and to change the structure optically and to improve the efficiency of light intensity would be quite difficult.

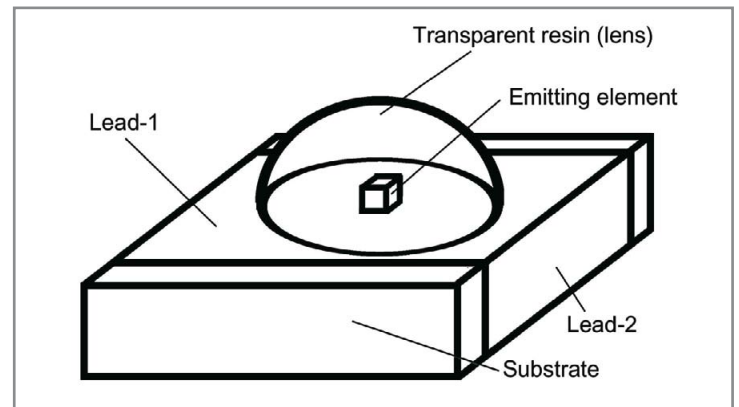

Figure 2: Structure of Surface Mount Type LED.

The Reflective Mirror Type LED

The LED that was developed to overcome the weak-points of both, plastic molded type LED and surface mount type LED is "Reflective Mirror Type LED" (Figure 3).

The emitting element (LED die) is installed face-to-face with the reflective mirror made with the metal film, and the space between the mirror and the LED die is molded and fixed with the transparent resin. The light from the LED die emitted onto the integral mirror inside of the package is reflected to the outside as the parallel beam. Though the transparent ratio of the molded resin and/or the reflective ratio of the inside mirror would effects to the light intensity, approx. 90% of all light emitted from the LED die can be irradiated efficiently as the well-controlled ray, due to this special packaging structure.

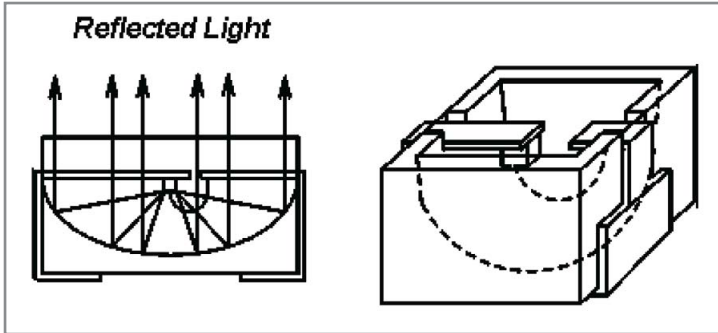

Figure 3: Structure of Reflective Mirror Type LED.

The Reflective Mirror Type LED as "Surface Mount Device"

Another advantage of this mirror type LED is that it can be soldered and assembled with 'surface mount'. As a result of the study and experiments to find out the best solution (e.g. the size and dimension of the package, the conditions of the metal film, the ingredient and hardening conditions of the molded resin, and so forth) the surface mount LED with the perfect performance was finally realized as "Reflective mirror type LED".

Optical Characteristics of Reflective Mirror Type LEDs

As shown in Figure 4, it has an excellent light distribution. As for the normal molded type LED, in order to make the light condense higher, the deterioration of the light balance would be inevitable. However, since the shaft radiant intensity is approximate 3 times as high as the one of the normal molded type LED, the emitted light is perfectly balanced.

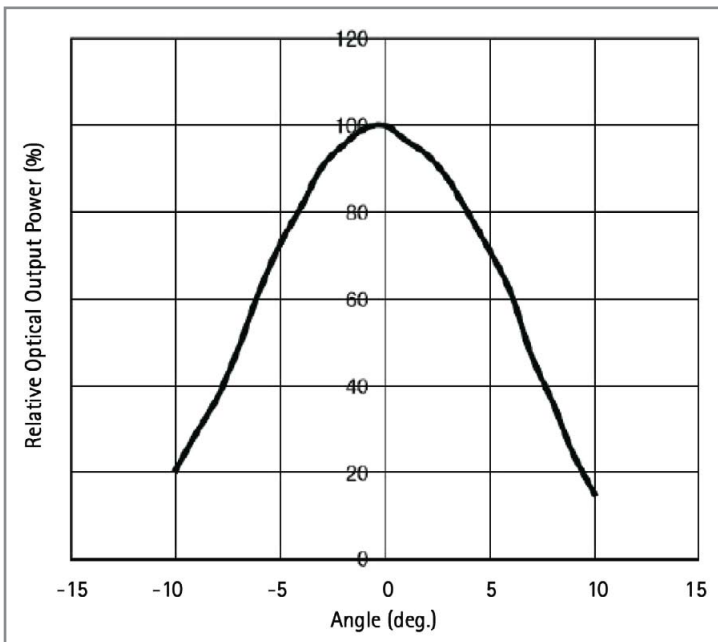
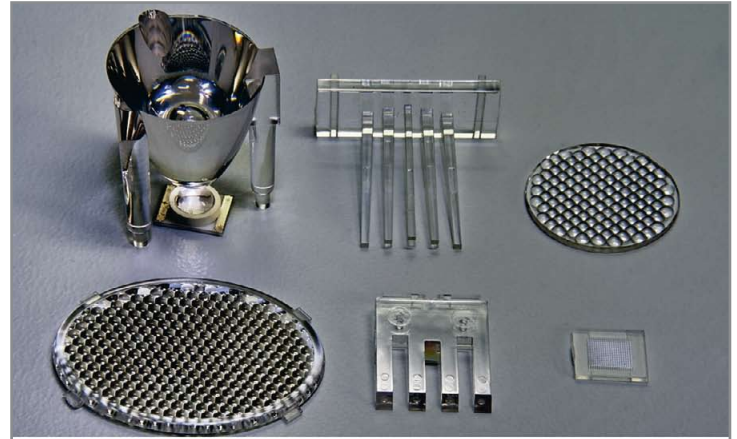

Figure 4: Light Distribution of mirror type LED.



Light - your idea for optical polymer solutions

We are your competent partner for polymer optical components and optoelectronic and optomechanical modules for various applications in the field of lighting.

- flash light modules
- automotive signal lighting
- street lighting and illumination
- architectural and effect lighting
- replacement of light bulb
- display backlighting
- message signs
- LED illumination solution for sensor systems and medical application

Optical Systems
sales@jenoptik-ps.de
www.jenoptik-ps.de



www.ledlightforyou.com

Our partners are looking forward to your ideas.

More than 50 partners world-wide await you in the LED Light for you network. These OSRAM-certified providers will be pleased to assist you in finding the right optical, thermal and electronic solutions for your lighting application.

The network for LED lighting technology.



Emitted color	Peak wavelength	Light intensity
Blue	470 nm	20,000 mcd
Green	530 nm	18,000 mcd
Yellow	590 nm	19,000 mcd
Red	625 nm	25,000 mcd

Table 1: High performance of the mirror type LED (standard package @ $I_f=20\text{mA}$, $T_a=25^\circ\text{C}$)

The only weak-point of the reflective mirror type LED is not to make the ones with various kinds of viewing angles so easily. The metallic film functioned as "mirror inside" need to be changed in order to make the LED with different viewing angles, and it costs too much.

However, by utilizing the top surface formed with half-luster evaporation technology, the LEDs with the following viewing angles have been already developed without changing the metallic film inside of the package.

- Standard packaged model (6x6mm): $\pm 7^\circ/\pm 8.5^\circ/\pm 10^\circ/\pm 12^\circ$
- Larger packaged model (8x8mm): $\pm 4^\circ$
- High Power packaged model (8x8mm): $\pm 14^\circ$

Optical Alignment

The production process of the traditional molded LED is as follows: The several lines of lead-flame on which the LED dies are already installed, as they are hung dangling in midair, are inserted into the concave mold formed optical lens (Figure 5). After hardening the molded resin by heating, the lead-flame with dies are put outside. Due to such processes, it is quite difficult to align the location of LED die and the lens surface optically, and the shaft radiant intensity cannot be controlled very well.

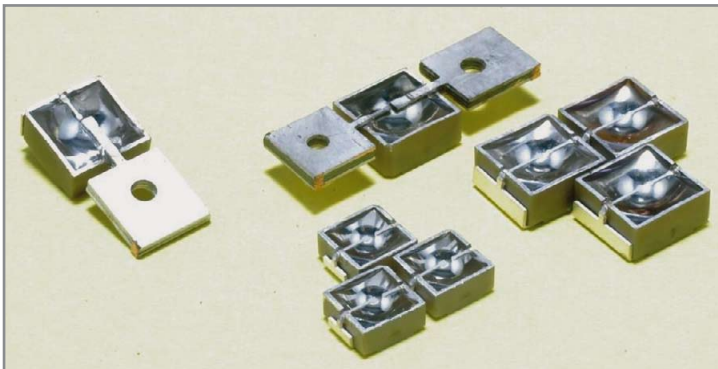

Figure 5: Variations of Reflective Mirror Type LED.

To the contrary, as for the reflective mirror type LED, since the position of the inside metal film (mirror surface) and the LED die are fixed during the production process, the optical tolerance can be minimized. In addition, the flatness at the backside of the package allows to arrange the optical alignment easily.

Figure 6 shows the unit that was developed with the optical alignment with the high power reflective mirror type LED and the Fresnel lens. The viewing angle of one LED installed on this unit is $\pm 14^\circ$. However by putting the Fresnel lens in front of each LED, the excellent beam ray with $\pm 4^\circ$ and long distance irradiation are realized.

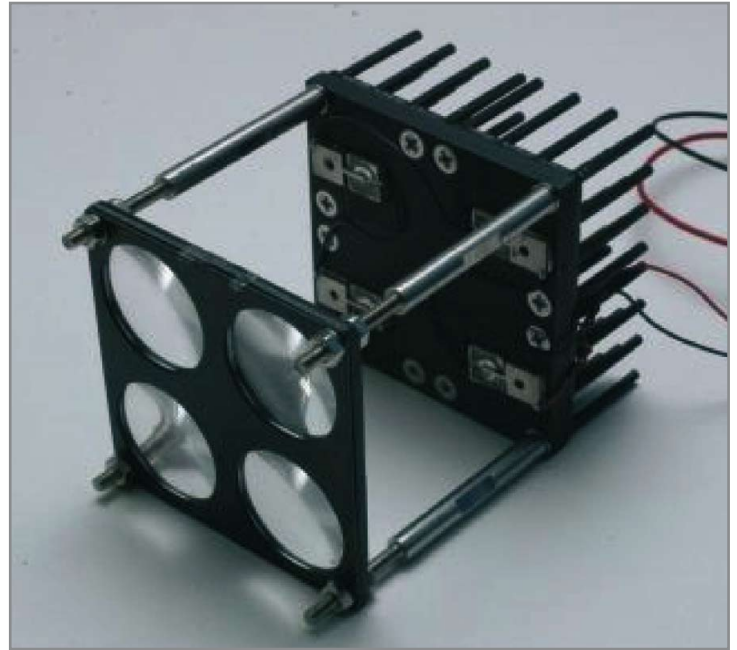

Figure 6: IR Illumination unit.

With such excellent optical features of the reflective mirror type LEDs, the light illuminator for a long-distance application can be designed effectively.

Summary

Recently, the development of high intensity emitting elements has been remarkable. In the aspect of the environmental problems all over the world, the usage of the Light Emitting Diode becomes the focus of the public attention. Under such situations, the Light Emitting Diode has a large potentiality to be used for various kinds of applications and fields in the future and will become an important device which carries the expectation of the development of the several industries. ■



LED CHINA 2010

— The Leading Global LED Event

Time : March 2 - 5, 2010

Venue : China Import and Export Fair Pazhou Complex, Area B (Guangzhou)



LED CHINA, the first global trading platform for LED chip, encapsulation, lighting, photoelectricity display, illuminant and equipment, etc. Owing to the great successes of previous editions, it has earned the reputation of an indicator of LED industrial development in the world.



In year 2010, LED CHINA, SIGN CHINA and NEON SHOW will be held under the same roof again. The total exhibition area will be up to 80,000 square meters with 1,000 exhibitors attending. LED CHINA 2010 anticipates gathering 350 exhibitors taking 25,000 sq. m. exhibition space.



 www.LEDChina-gz.com

A perfect purchasing chain for global buyers gathers the leading LED enterprises with the most advanced products in China!

Trust Exhibition Co., Ltd.

Tel: +86-20-3810 6261, 3810 6263

Email: LED@TrustExhibition.com

Fax: +86-20-3810 6200

Website: www.LEDChina-gz.com



Optics

All Facts for Choosing LED Optics Correctly

> Tomi Kuntze, President, LEDIL Oy

Putting together a functioning LED lighting solution always includes the specification of the optical performance of the product. As with many emerging technologies, LED technology being no exception, it may be very challenging to specify and choose the best components to fulfil the requirements set. The main reason is that there are no standards available. Lack of standards easily leads to varying interpretation of the parameters by different suppliers and it may mean that a wrong or non-optimal component is chosen.

Because of that reasons it is important to enlighten the real content of the optical parameters such as FWHM, Efficiency, Materials and Lifetime, to allow customers to better understand which optical component is best for which application and how to choose it in a correct way.

Efficiency

Optical efficiency of a component is normally defined by measuring how much of the total lumens sent into that component come out of it, through the optical surfaces defined. If we take as an example a common collimator lens for an LED, it means that first the total lumens of the LED are measured in an integrating sphere (Figure 1). As a second step, the lens to be measured is placed on top of the LED and all other surfaces but the light out-coming (front) surface is covered with black, absorbing cylinder. And again all the lumens out of this system are measured in the same integrating sphere. The efficiency is the ratio of these two lumen values, multiplied with 100, to get out the result in %.



Figure 1: Measuring efficiency of a lens takes place in an integrating sphere.

Now, it is important to understand that this efficiency gives an impression of how good an optical system is in terms of handling the light sent into it, e.g., this value for a lens of good quality may be 91%. But this 91% does not at all characterize how good a lens is for a given application. It does not give the person, specifying his lighting system, any information of how much of the light comes in his needed area or angle – in other words what would the "useful" efficiency of the component be. To understand it, we need to continue specifying more parameters.

Shape of a Light Distribution Curve

In illumination engineering it is very important to see the total shape of the light distribution curve. A light distribution curve is a 2D- or polar diagram characterization of the performance and it tells for an experienced eye what in detail to expect of the component, e.g., how narrow the light distribution is, are there any discontinuation points to be expected (shadows) or what the relative intensity is in HV 0 degree vs. 30 degrees. A Full Width Half Maximum (FWHM) angle has been defined, in relative terms, for a symmetrical optics with its maximum intensity in the middle of its light distribution (horizontal and vertical 0 degree), to be the angle, where the intensity of illumination has dropped to 50% from its maximum peak value. Furthermore, many advanced companies define a further so-called 10% value, which is the angle, where the intensity of the illumination has dropped to 10% of its maximum peak value. This is a very useful parameter, e.g., when specifying optical components with an extremely narrow light distribution. The closer the 10% value is to the FWHM value the more light is really focused in the important narrow beam and the less stray light you have outside of the main beam.

Now, one may wonder, why to use two values for a component, FWHM and 10% value, why is not FWHM itself sufficient? The reason is that FWHM value is not unambiguous, and it can even be misused to mislead a person specifying his system.

Let's take a simple example with imaginative lenses A and B (Figure 2). Lens A is a lens with relatively bad optical efficiency and additionally, a proportionally big share of light falls outside of the centre beam area, i.e., its 10% value is a wide-angle value. Due to the shape of its light distribution curve – a flat curve with no really high peak in the middle, but more or less a "hill" type of a shape – it still has a FWHM value of +/- 5 degrees.

The other lens, lens B, is a lens with high optical efficiency, with very concentrated beam and a narrow-angle 10% value. Its curve shape reminds of a Himalayan mountain instead the hill for lens B. The surprising fact is that this lens has the same FWHM value of +/- 5 degrees, as lens A. How can it be possible? Putting the absolute (not relative) curves of these 2 lenses on top of each other in the same diagram, shows that lens B gives 5x the light than lens A, but still the FWHM values are identical! The conclusion of this simple example is that different lenses cannot be compared against each other just using FWHM values. FWHM does not give the answer to the question how much absolute light is distributed in the specified angle or area. More facts are needed, 10% value already gives a good hint of how an optical component performs.

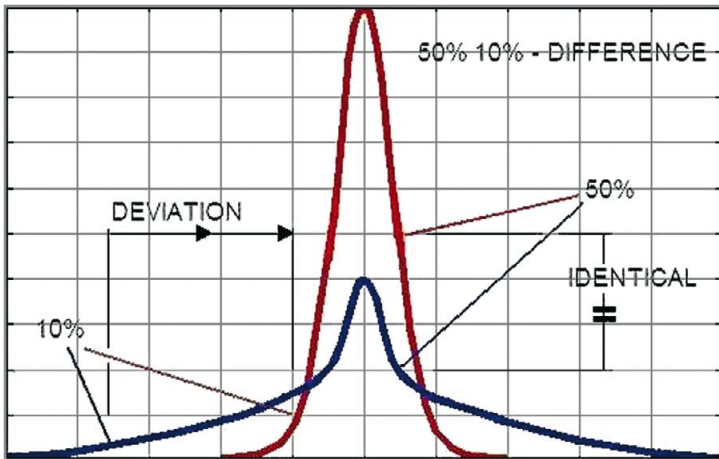

Figure 2: FWHM value does not give unambiguous information of an optical component. These two lenses have the same FWHM value, but they perform in a very different way (lens A: Blue; lens B: Red).

Cd/lm Value

When the person specifying an optical system has the information of optical efficiency, FWHM and 10% value and in addition the cd/lm value, one might think the optical system is fully specified. The cd/lm (candela per lumen) is a very important complement, as it specifies the height of the light distribution curve in absolute scale. In other words, it enables putting the curves of several different optics in one and the same diagram to see which optical component gives most light in the angle or area needed for an application. However, one must remember that cd/lm value needs to be seen in combination with the other values specified above. The reason is that it is relatively easy to manipulate this value to be high on its own, if efficiency and curve shape are being sacrificed. There are too many bad examples of this: a component making a high peak in the middle, while the shape of the curve is of low quality and total efficiency of the system is low. In other words, this value has to be analyzed very carefully.

IES or EULUMDAT Files

Lighting industry traditionally uses these file types to characterize their products. Now these files are available for most LED optics on request, too. In practice the files are fully digitalized versions of the light distribution curve discussed above, i.e. they contain all the information needed: efficiency, FWHM, 10% value, cd/lm and much more.

What is very important to remember is always to ask for the measured data with detailed information of components and methods used, not to accept simulated data. Unfortunately some companies work with theoretical, simulated data only. This data may sometimes give much better values than the real data and lead to misunderstandings or even wrong component choices.

Plastic Materials

It is of extreme importance, always to use optical components, which are made of documented, high-quality plastic materials. The recommendation is to use automotive or medical grade PMMA (acrylic) or PC (poly carbonate) in all normal LED applications. These well-documented, tested materials guarantee a long lifetime for the

component without deteriorating performance over the component lifetime. - A long lifetime means a period of ten up to twenty years of continuous use. - Close to UV wavelength radiation from LEDs, sunshine, moisture and physical stress require much of the material used and normal materials are not made to withstand these conditions. Molecule chains get cracked and molecules change their appearance and performance, if the plastic material is not of sufficient grade.

It is explicit necessary to advise against using cheap lenses made of PS (Poly Styrene) or SAN (Styrene Acryl Nitride) or similar cheap plastics. Another critical component type is a plastic reflector with metal coating and protective surface treatment for environmental protection. Typical for all these cheap materials is a low weight in comparison to PMMA or PC, which makes it relatively easy to recognize them. The cheap price is due to low material price per kilogram, faster speed in molding or poor process in coating / protecting reflective surfaces. Very often this cheap price may turn to be very high in the long run, when lenses turn yellow, milky or the metal surface turns matt and the efficiency and appearance of the light changes much from the original specified one. Also from the beginning on, the optical performance and characteristics for these lenses normally are lower than for the ones made out of quality materials, due to low quality molds used in production, too.

LED Specific Optics vs. General Optics Used for Different LEDs

Many companies offer so-called general lenses that are offered for various LED types and only adjusted by height to get them on the correct focal plane. Using the same lens for a light source that is different from the one the lens was originally designed for, leads automatically to decreased performance. Speaking with the terms defined above, at least efficiency is affected, cd/lm ratio, too, and normally also the shape of the light distribution curve (FWHM, 10% value), even if, in the best case, the illumination looks nice. How much the decreased effect is in reality, depends on how big the difference to the original light source is (Figure 3).

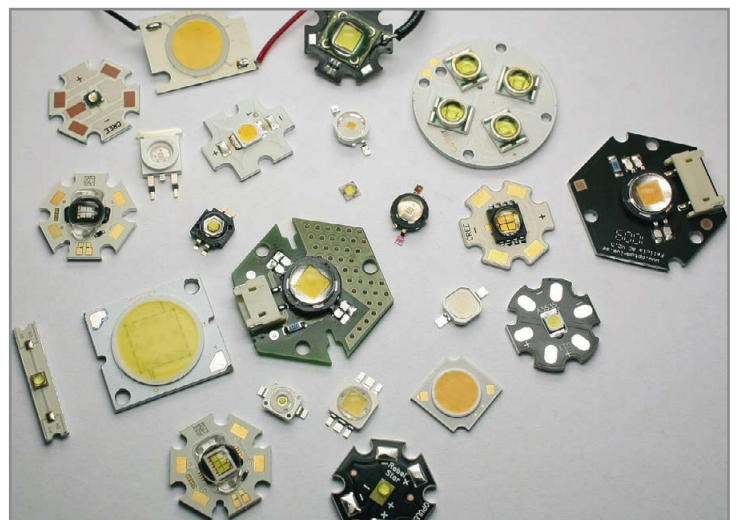

Figure 3: Differences between LEDs make it impossible to make a universal optical component for all or a multiple of them.

The only really sustainable way of making excellent optics is to design it separately for every light source. It is of course a much more expensive way to go, as optical grade injection molding tools are very expensive and design time for each lens is long, too, but only with light source specific optics measured efficiencies of more than 90% and measured high cd/lm values can be reached.

Differences in Performance for Different Lens Types

One may simplified say that the easier and the more controlled the requested light distribution is, the better is the performance. Spoken in practical terms, often a pure collimator lens has the best overall performance, for the best ones highly over 90%. Making optical versions of the same collimator design by changing e.g. its top surface normally leads to decreased efficiency, the grade of decrease depending on the complexity of the change and the machining quality of the changed surfaces. In worst cases the decrease may be significant – up to 10-15% drop in performance.

If an optical component is from the very beginning designed for an asymmetric distribution, the performance is not compromised in the same way as when making versions based on e.g., a collimator design. High performance values above 90% efficient can be reached, as e.g. LEDIL's STRADA lenses. However, if a lens design is very challenging e.g. due to tilting the distribution strongly, or making it extremely wide, or an extreme batwing distribution is needed; it normally decreases the efficiency values. Therefore, always optical components of similar type and similar size must be compared; otherwise the performance comparison is not on a fair basis.

Size of Optics Matters

Generally spoken, the bigger the optical component is, the more accurate it is and the better the performance is (Figure 4). But it is also generally understood that big components often are pricey, and in many applications the benefit from the LEDs comes from decreasing the size or, alternatively, the space available may be needed e.g. for electronics components.

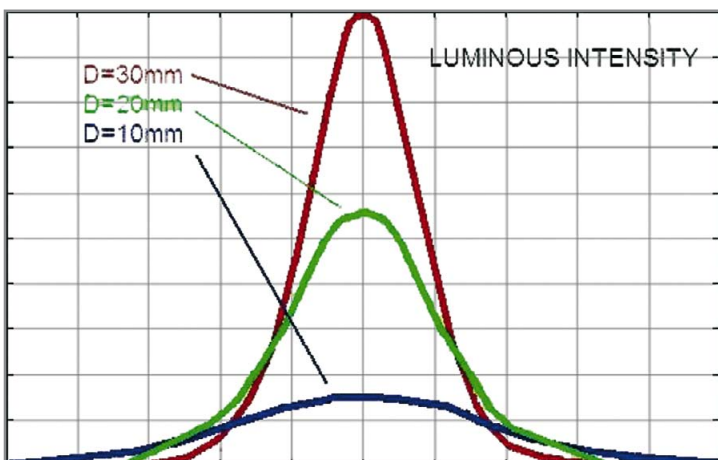

Figure 4: The bigger the size of the optical component is, the more accurate the component is (difference in beam shape).

Over the years, some component sizes have become an industry standard. A good example of such standard sizes is the so-called 21 mm round lens. This size is very optimal for the modern small point light source types of LEDs, such as Luxeon Rebel, Cree XP, Osram Oslon or Nichia 119. The performance would not become significantly better for standard applications, even if the size was increased. Making the same lens smaller to 16 mm can still keep the good efficiency at over 90%, but cd/lm values would drop slightly, as accuracy would decrease due to proportionally bigger light source vs. lens. Going even smaller, to less than 10 mm, would mean also a drop in efficiency, as again proportionally the light source would grow so large that a small lens can no more capture the light in an efficient way. Practically spoken an efficiency of 80-85% could be reached in this particular case.

For most modern LEDs, 21 mm size seems to be sufficient to satisfy the needs in most applications. In many applications customers choose smaller lenses, 16 mm or even less than 10 mm, because of the reasons mentioned or to be able to populate even more LEDs per area given. It is notable that an increased size to 26 or 30 mm or even larger only is needed for special applications, where a very narrow distribution, typically a total FWHM of 3-4 degrees is specified, or for complex distributions, where light is refracted using several different optical elements.

Reflector vs. Lens

For all modern small light sources with one to four dies and a primary lens, the best solution to use, from optical point of view, always is a lens. The explanation, why a lens is the best, is simple: in a lens, the beam can be controlled very well. There are at least three surfaces for use, while for a reflector there is only one, or, for a reflector system, two surfaces. The efficiency of a lens also is very high, if the optical system is designed in an advanced way, using free-form technology. For lenses in general, it is possible to achieve an efficiency of at least 90% for most applications; for the all trickiest ones at least 85%. For a reflector it is possible to achieve a reflectance of 90% for the metal-coated surfaces, but the overall beam control is far less efficient compared to a lens.

It makes sense to use a reflector design, when the size of the light source is large and the light source consists of an array of dies under a common phosphor layer. Examples of such light sources are e.g. the most Citizen and Bridgelux LEDs. For these LEDs, making a lens would mean to design a huge lens, to enable capturing of the light in a controlled way. As making a huge lens also means high costs, to avoid these, it makes more sense to design a reflector or reflector system. The efficiency and \$/lm of a light fixture with this kind of an optical design remains at a good level: what is lost in optical efficiency due to the size and multi-nature of the light source is gained back in the good thermal efficiency of the system and lower price of the light source itself, compared to point light source types of LED.

Mixing of Different Lenses in One Application

Quite often, a request for a specific light pattern can easily be achieved by using several different standard lenses. A simple example of this is a normal car head lamp: there needs to be one specific solution for the low-beam light, while the high beam light can be achieved by using another optical system and the daytime running lamp using a third one. It does not make sense to try to make all this with one optical element only – would be all too complicated and expensive.

In general illumination, there are many similar examples: an object needs to be illuminated with a spot lamp, while the surrounding area also needs some light – not as much, but it needs to be illuminated as well. This can in practice be done with a narrow spot lens for the object itself, while a wide-angle lens in the same light fixture takes care of the general illumination around the spot beam.

Another good example of mixing can be found in street lighting (Figure 5): the requirements vary a lot from case to case and it is very difficult to directly address all needs with a single optical solution. Instead, the idea is to provide customers with a selection of standard components, which mixed can achieve any light distribution requested. It is a much simpler and more flexible approach than making special optics for each case separately. Of course this approach requires a very wide selection of lenses only a few optic suppliers can offer.

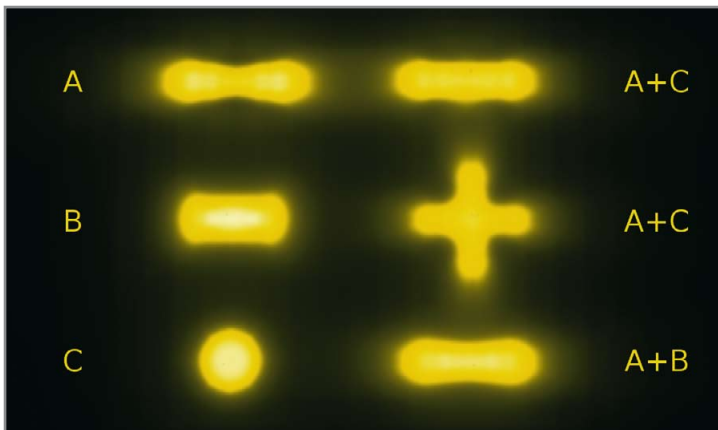

Figure 5: The performance of single lenses of the types A, B and C on the left hand side and the result when mixing them on the right hand side are demonstrated. With a clever mixing many different pattern can be achieved.

Cost of Assembly

A very important aspect in using optical components is to try to decrease the cost of assembly, while maintaining the accurate positioning principle needed for any good optical design. The rule generally is that the better the optical efficiency of an optical component is, the more sensitive it is for correct placement. In other words, the ease of assembly shall never jeopardize the accuracy of the positioning. In many cases, glue and/or positioning pins have been the solution. The increase of use of optical assemblies for LEDs has, however, also increased the need for better, more production-friendly solutions. One good possibility to solve this challenge is to use adhesive tape of high quality and of automotive grade. It makes the assembly work very easy, while maintaining the accuracy needed.

Another solution for easy assembly is to use snap hooks, which go through the PCB and self-lock the optical component to the PCB. The challenge here is to define the thickness of the PCB with narrow enough tolerances. If this tolerance definition is narrow enough, this solution is superior in costs compared to any other solution.

Conclusion

Optical components for LEDs play an all more important role in deciding the success of a light fixture. It is a real challenge for every fixture designer to be able to specify the optical components in a correct way, to enhance the properties of the fixture, while keeping the costs down. There are quite a lot of parameters to take care of for each application and project anew. To satisfy the demands of the client the parameters of different optical solutions have to be compared very carefully and in detail. ■

Primary and Secondary Optic Materials – LED Luminaire Performance and Lifetime

> **Thomas Brukilacchio, Ph.D., Founder and President, Innovations in Optics, Inc.**

Numerous articles have been published regarding the lifetime of Light Emitting Diode (LED) luminaires, however, the primary focus has typically been on the lifetime of the LED die itself. Given that the LED luminaire is a system, it is important to recognize all aspects of the system that can affect or limit lifetime. Most luminaire designers are familiar with the need to optimize thermal performance evidenced by the large number of articles written on the subject. LED die lifetime has been shown to be driven primarily by junction temperature and to a lesser extent by current density, although the affects of current density and current spreading have been largely overlooked. LED luminaire designers are much less aware, however, of the importance of selecting the proper optical materials for the primary and secondary optics that comprise the luminaire with respect to lifetime degradation due to aging of the optics. The spectrally dependant loss in transmission due to aging is particularly acute in the blue and blue-green regions. In addition to a loss in total lumen output with time, the yellowing of the optics results in a decrease in Correlated Color Temperature (CCT), which can result in an unacceptable color change with time. The luminaire designer must be aware and take proper account of both of these material aging issues.

The greatest commercial demand for LED luminaires will be for broad spectrum white lights to replace conventional lighting products. The most efficient and common way to produce broad spectrum white LED light has changed very little since it was first invented and is based on conversion of blue light to yellow via one or more phosphors. The combination of the blue and yellow light produces white light. The short wavelengths emitted by the LED die below the order of 450 nm, however, cause a yellowing of the plastic optics with time which results in a loss in lumen output. LED phosphors have been shown to exhibit greater efficiency when excited by LED die with peak radiometric wavelengths below 460 nm. These shorter wavelength LED die result in a more rapid aging of the optics. The primary optics are typically positioned in close proximity to the LED die and therefore exhibit the most significant yellowing or aging affects due to the proportionally higher flux. In outdoor applications, the secondary optic is often exposed to harmful ionizing radiation from the sun, so consideration must be given to the potential aging issues for the secondary optics as well.

A number of system level trade offs must be considered to achieve a long life and low cost luminaire suitable for high volume production. For example, the choice of a shorter wavelength LED die would be expected to increase efficiency of a given luminaire initially, but may actually result in lower efficiency in the later half of a luminaire's useful life if the lumen

output degrades sufficiently as a result of yellowing of the optics and can result in a significant color change if the CCT changes appreciably. The challenge to developing improved optical materials will become more acute as LED die technology advances with ever increasing wall plug efficiency allowing for even higher optical flux. This article focuses on educating the LED luminaire design community as to the importance of selecting the proper optical materials for a given application and discusses relevant trade offs that must be taken into consideration.

Motivation for Considering Aging Affects for Primary and Secondary Optics

A limited survey and accelerated life testing of candidate high performance moldable optical polymers for high volume commercial lighting applications was carried out by Innovations in Optics beginning in June of 2008. The results of that effort led to the identification of two new polycarbonate materials LED2045 and LED2245, developed from Bayer MaterialScience, as comprising the best overall combination of characteristics for the predominance of commercial LED luminaire applications. These materials are characterized by low cost, excellent mechanical properties, resistance to yellowing/aging due to exposure to high flux and short wavelength blue LED light, high temperature performance, high internal transmission and excellent molding characteristics.

Bayer MaterialScience, as the company responsible for the invention of polycarbonate, has a long standing world wide reputation for developing innovative polymer products and for being proactive in meeting the needs of the lighting community as is evidenced by the recent development of the LED specific polycarbonates LED2045 and LED2245. In fact, if it were not for the recent development of these products, many high volume opportunities would not have continued to successful product launches. Other materials were identified that could have met most of the requirements, but cost would have been prohibitively high for some, or maximum temperature too high for others. Future optical material surveys should include a wider and more comprehensive evaluation of all relevant classes of optical grade moldable polymers to see if other equally suitable optical polymers exist.

The recent development of moldable lens grade silicones offers another choice for applications that are not price sensitive, however, they are deemed too expensive for high volume and low cost luminaires due to the long required cycle times and high cost of material and are not addressed further. Silicones should be considered as a viable alternative for less price sensitive applications, however. It should be also noted that there are some Cyclic Olefin Copolymers (COC's) that showed great promise, but would likely be too expensive for many commercial applications such as the Zeonex 350R recently developed by Zeon Chemicals. The 350R was specifically developed as a lens material for 405 nm laser diodes for optical storage devices and demonstrated excellent resistance to yellowing. Unfortunately, the 350R's glass transition temperature is the order of 24°C lower than the Bayer material's 147°C and costs significantly more per kilogram making it unsuitable for many high volume applications requiring extended temperature performance and low cost. With respect to

temperature, it is important to understand that the LED die temperature can be significantly above the ambient temperature and this is a major driver in the need for high temperature materials. Additionally, a number of acrylic materials showed great promise with respect to resistance to yellowing such as UVT920 and UVT825-100; however, their low glass transition temperature on the order of 85°C makes them unsuitable for many commercial applications. These excellent optical grade acrylics should be given close consideration in applications that have limited temperature ranges as they are low in cost, mold well, and have low dispersion relative to polycarbonates which would result in less chromatic aberration when used for imaging optics relative to the polycarbonates. The COC's are attractive in that they resemble the polycarbonates mechanically, but are closer to the acrylics with respect to optical properties. In general, lower refractive index optical materials are preferred as they result in lower Fresnel (air/glass interface) reflective losses. One drawback of the polycarbonates relative to the acrylics and COC's is their higher index of refraction on the order of 1.58 relative to acrylics' 1.49 and the COC's 1.53. Further improvements in the polycarbonates should also focus on achieving lower refractive index without giving up other desirable properties, if feasible.

There are many aspects of an LED luminaire that must be given careful consideration to result in a high performance, low cost and long lived product consistent with the Department of Energy's (DOE) long term solid state lighting (SSL) initiatives. One of the most significant hurdles in meeting the longevity goals is the availability of suitable polymer materials out of which the high efficiency primary collection optics as well as secondary optics of next generation luminaries will be comprised. Based on accelerated life testing, the extrapolated expected lifetime of the LED die is already in excess of the 50,000 hours at greater than 70% initial brightness for the best commercially available LED die for typical and even aggressive operating conditions. The excellent thermal performance and low cost LED Chip-on-Board technology manufactured by companies such as The Bergquist Company and used by Innovations in Optics and other industry leaders is capable of exceeding 50,000 hours with today's technology for high flux and high brightness luminaries with respect to the long term performance of the LED die themselves. That is not to say further improvements are not warranted with respect to LED die performance, as they are, but the focus of this article is on the primary and secondary optic materials, which are recognized as significant contributors to luminaire aging manifest as both a loss in lumen output and a decrease in color temperature.



MinleonTM

A Leading Manufacturer & Distributor of Quality Holiday, Decor & General Use LED replacement Bulbs and String lights

LED professional

LED Ceiling Panel

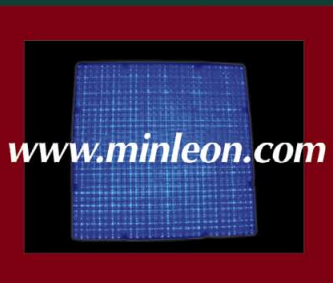

www.minleon.com

Minleon International Ltd.
Dongken Town, Dongken City
Guangdong Prov, China 523450
website: www.minleon.com
email: info@minleon.com

Minleon International is a leading manufacturer of high quality LED lighting products. Featured products include retrofit/replacement LED bulbs in the holiday, décor and general use markets. Minleon has an in-house professional design team for tooling, custom plastic molding, SMD and assembly. Minleon has a branch facility in the USA to warehouse product and provide hands-on customer service to its nationwide network of distributors and their customers.

www.minleon.com

LED lamps



www.minleon.com

Minleon International USA Ltd.
3920 Market Street
Camp Hill, PA 17011
Toll-free 866-670-0422
email: minleonusa@live.com

Recent improvements in the index matching silicone gels by companies such as Nusil, Shunitsu and others can also meet the demands of >50,000 hour white light luminaries. There is work required for extending the silicone gel performance down to shorter wavelengths in the ultra-violet (UV). White luminaries, however, are generally more efficient when comprised of blue absorbing phosphors, than UV absorbing phosphors. Thus, for the most significant white light applications, the best available silicone gels used today are already sufficient for long lived luminaries. The fact that UV excited phosphors are fundamentally limited by physics to being lower in efficiency for white light applications is related to the quantum deficit in energy that exists when an absorbing photon of one wavelength is emitted and Stokes shifted to longer wavelengths. For example when a UV photon at 380 nm is absorbed by a phosphor of unit quantum efficiency and then the energy is converted by the phosphor and emitted as a green photon at the photopic peak of 555 nm, there is an energy loss of 31.5%. The balance is converted to heat. When, however, a blue photon at 450 nm is absorbed by a phosphor of unit quantum efficiency and then converted to 555 nm, there is an energy loss of only 18.9%, thus the production of white light, to first order, is fundamentally more efficient when using blue excited phosphors due to this quantum deficit. This is the reason that red emitting phosphors are generally characterized by poor radiometric conversion efficiency.

There are other considerations including the increase in scattering (and thus backscattering losses) with decreasing wavelength and the general increase in absorption cross section for most (commercially available) phosphors with decreasing wavelengths that must also be taken into consideration. Therefore, when it comes to developing more efficient luminaries, development dollars should be focused on inorganic blue excited phosphors with enhanced absorption cross section, reduced backscattering, high quantum efficiency, and low thermal quenching, over those designed to excite in the UV. Furthermore, the silicones used to attach the phosphors for UV excited phosphor luminaires degrade in transmission themselves, as all silicones developed to date degrade much faster when exposed to UV energy than when exposed to blue energy. That is the reason that high flux UV LED die can not be encapsulated as the silicone gel encapsulants typically used in the visible would lead to catastrophic failure as validated by UV accelerated life tests conducted at Innovations in Optics.

The motivation for this discussion is that the choice of phosphor and excitation wavelengths necessarily affects the requirements imposed on optical polymers used in luminaires. Improvements in phosphors will increase luminaire life and wall plug efficiency, but if anything the improvements in the LED die efficiency and phosphors will result in even higher flux on the molded optics, presenting a greater and ever increasing challenge to the SSL community to develop new polymers that can resist the flux induced yellowing/aging observed by varying degrees in all of today's commercially available moldable polymers.

Figure 1 shows the recently released LumiBright LE light engine product line which incorporates a primary collection optic as part of the device and is representative of next generation high performance LED modules and is suitable for high volume commercial lighting applications. For example, this light engine can be incorporated into a recessed lighting fixture to deliver high efficiency and uniformity white lighting to residential and commercial fixtures. The integrated light homogenizing and high efficiency collection optic results in an excellent beam profile with no additional optics, or alternatively could be combined with secondary optics to shape the beam into other desired forms and beam profiles. These light engine incorporates an on-board thermistor and photosensor for monitoring or closed loop control if desired. The LED die are attached directly to the gold coated copper heat spreading substrate for excellent thermal performance. The patented and patent pending molded optics redirect some of the light back toward the on-board photosensor such that the sampled light is representative of the combined output from the entire LED die array and also would account for a loss in output over time due to LED die or optical plastic aging affects. Thus, a simple control loop circuit could allow this device to emit constant output over the lifetime of the product. For products not requiring temperature or light monitoring or control, the components could be left off the board for reduced system cost. The product line is representative of state-of-the-art LED technology that will be incorporated into tomorrow's next generation lights and has been developed to use the Bayer Makrolon LED2045 and LED2245 materials.



Figure 1: LumiBright LE line of light engines for commercial applications and incorporating high efficiency primary optics, photosensor, and thermistor on a high thermal conductivity metal core PCB in one package.

Figure 2 shows a rendered cross sectional view of one of the LumiBright LE light engines. The square input aperture of the primary collection optic is positioned just above the LED die array which is attached to the metal core board. The flux through the entire homogenizing section of the optic is close in magnitude to that emitted by the LED die array until it is decreased as it travels up the optic by virtue of spreading out in area. The combination of high collection efficiency and homogeneity of the light exiting the output aperture makes this device very suitable as the heart of a high volume recessed lighting fixture, for example, but could be used in many other commercial applications as well.

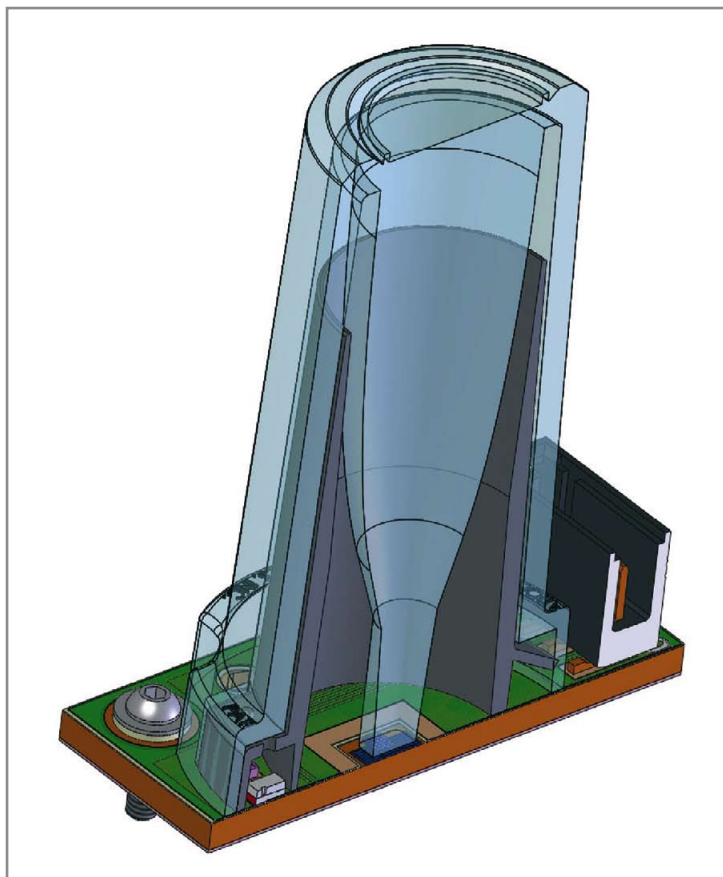

Figure 2: A rendered cross sectional view of a LumiBright LE light engine is shown. The light enters the primary collection optic aperture which is positioned just above the LED die array.

Accelerated Life Testing of LED Optical Materials

One of the most critical developments necessary to achieve low cost, long lived LED luminaires is in the area of polymer development as motivated above. The development of advanced polymers that will be capable of meeting next generation LED luminaire requirements necessarily requires an understanding of the underlying limitations and operating conditions of representative luminaires. A primary failure mechanism with respect to achieving long life and stable color for a LED luminaire is the aging of the polymer materials with exposure to high intensity blue and long wavelength UV photons emitted by the LED/phosphor matrix and entering the input aperture of the primary molded polymer optics in a manner shown in Figure 2, where the flux and temperature is typically the highest. Relevant accelerated life testing protocols must necessarily be developed to evaluate the suitability of a given polymer sample.

It is necessary to quantify acceleration factors for any legitimate accelerated life testing. The method used to evaluate the LED2045 and other selected material candidates was to first establish the current density for normal operating conditions for a representative LED luminaire application. A standard Cerium Yttrium Aluminum Garnet (Ce:YAG) phosphor with a mean particle size of 5 microns was assumed

in conjunction with a blue LED die with a peak photometric wavelength of 455 nm using a standard 42 mil LED die with a nominal operating current density of 800 mA/mm². This luminaire example was designed to emit white light, so the amount of blue and UV light entering the input aperture of the optic would be reduced by the phosphor matrix due to backscattering of the non-absorbed light and conversion of much of the blue light to longer wavelengths.

Initially, various blue LED die were tested with a range in peak wavelengths without using a phosphor to determine the portion of the blue spectrum which results in the greatest aging effect. As expected, shorter peak wavelengths (higher energy) resulted in greater degrees of yellowing, and thus would decrease the lifetime of the luminaire faster than longer peak wavelengths. In general, shorter blue excitation wavelengths result in increased efficiency due to the spectral dependence of the absorption cross section of the phosphors. That is, shorter peak blue wavelength LED die increase the device efficiency to some extent, but they also decrease its lifetime due to the faster rate of bond breaking occurring due to the higher energy photons.

The reason that the shorter wavelength excitation works better is that the increased absorption cross section results in a decreased phosphor layer thickness which in turn results in reduced backscattering of the excitation light back into the LED die where it has an opportunity to be reabsorbed before it is scattered back into the phosphor for a second chance at either being absorbed by the phosphor or scattered through the phosphor to add to the phosphor's yellow emitted light and thus produce the perception of white light. The author recognizes that this seems contrary to the discussion on quantum deficit and that this shows that competing effects can play a role. The shift toward shorter wavelengths considered here is only on the order of 10 to 20 nm. The increased absorption cross section in this case more than compensates for the increased quantum deficit with decreasing excitation wavelength, but in general, the quantum deficit discussion is valid. With typical commercially available phosphors, this affect also overcomes the increased scattering that would occur at shorter wavelengths as the wavelength shift is not that great.

A significant difference in the aging rate for polymers subjected to lower energy 473 nm peak dominant wavelength LED light was observed in comparison to the proportionally higher energy 455 nm peak dominant wavelength LED spectrum. Thus, one of the trade offs between lifetime and efficiency is related to the choice of wavelength for the blue LED die used to excite a particular phosphor in a white light application. Therefore it is necessary to recognize that it is the difference in the flux at the shorter wavelength side of the typical blue spectrum that is most important with respect to aging affects and in the calculation of the acceleration factors. It is also important to recognize that the spectrum of the blue light component that scatters through the phosphor and makes its way into the collection optic is necessarily modified by the non-spectrally flat absorption of typical phosphors in the spectral region of interest. A radiometrically calibrated spectrometer was used to quantify the integrated power at wavelengths below about

465 nm entering the input aperture of the collection optic with and without the phosphor matrix present. This resulted in a factor of 7,3, meaning that if the phosphor is left off the LEDs then the input aperture of the polymer optic would be subjected to 730% the amount of light in the shorter spectral band that is responsible for aging which manifests as increased yellowing, assuming the LED die is run at the same current density in both cases. The factor is dependant on the amount of phosphor used, so the CCT is a factor. For the above analysis, a nominal CCT of 5,700 Kelvin was used.

It is desirable to achieve high acceleration factors in order to minimize the total time required for a given accelerated life polymeric material characterization, but they do need to be based on practical and representative luminaires. From the above discussion we can see that, for a CCT of 5,700 Kelvin, the acceleration factor just due to the decreased blue flux in the presence of the phosphor layer is the order of 7.3. This factor is also a function of the degree of backscattering which is related to the particle size relative to the incident wavelength. Smaller particle sizes generally lead to decreased backscatter, which in turn results in enhanced efficiency. This assumes the resulting phosphor particles do not have increased surface dislocation losses due to the process of decreasing the particle size. Thus, smaller mean particle sized Ce:YAG phosphors have generally been found to be more efficient than larger particle sizes and thus would result in reduced acceleration factors, which need to be taken proper account of.

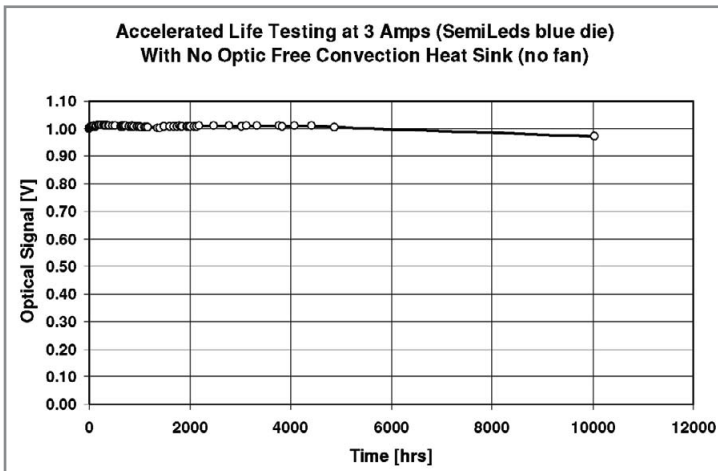

Figure 3: The intensity versus time is shown for a single blue LED die from SemiLEDS operated at a current density of 850 % nominal indicating how far LED die technology has progressed.

Now, as noted above, the particular device being characterized had a nominal operational current density of 800 mA/mm². The LED die industry has standardized on a current density of about 350 mA/mm² under normal operating conditions. This is partially historical due to the fact that many of the older generation LED packages used very poor thermal dissipation methods and were encapsulated by epoxy resins that degraded precipitously at junction temperatures approaching 125°C, thus relatively low current densities became the standard for defining LED characteristics. The best LED die available, of which the SEMILEDS 42 mil blue die is representative, can be operated at many times this current density continuously. This is shown in Figure 3, for

which the LED die was running at room temperature on a heat sink cooled only by free convection at a current density of 3 A/mm² which was over 8.5 times the 350 mA nominal operating current of its associated data sheet. The junction temperature at this high current density was on the order of 125°C. Thus it is possible to increase the flux further beyond that produced at 800 mA by running the LED die at the order of 3 A/mm².

From the plot of Figure 4, we can see the output power of a single blue 42 mil SemiLEDS die is a factor of 2.6 times higher at 3.0 A in comparison to that at 0.80 A. This factor of 2.6 in combination with the factor of 7,3 from the phosphor gives an acceleration factor of 19 times. Thus to first order, a polymer optic subjected to the flux from a closely spaced blue SemiLEDS die operated at a current density of 3.0 A/mm² would be expected to last about 19 times longer over the spectrum of the blue LED die with the phosphor located on the die.

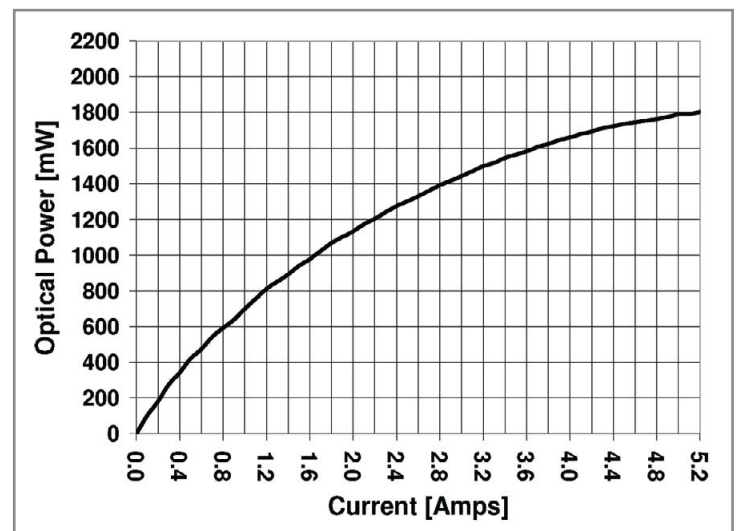

Figure 4: A plot is shown of the optical power versus input current of a single SemiLEDS 42 mil 460 nm blue die mounted on a LumiBright copper PCB.

Let's assume for the sake of the present discussion, that the definition of lifetime for a given LED luminaire is the total cumulative running hours at nominal operating current, temperature and humidity for which the luminaire maintains at least 70% of its initial brightness. Then we can estimate the degradation curve for a given luminaire by multiplying the hours by a factor of 19 and determining when the output would fall by 30%. Now, we must consider that the definition is applied at the system level, so that any loss in light due to the LED die itself, the phosphor, or the phosphor matrix, index matching gel if used, or any other loss factors including the drive electronics must be part of the total loss budget. Therefore a power loss budget must be established for which only a certain fraction of the 30% total budget would be available for loss due to the polymeric optic.

For example, Figure 5 shows the decrease in output of the bare LED die for operation at 800 mA derived from data taken at 3.0 A assuming the ratio of currents as the acceleration factor. There are a number of assumptions here, including that the full degradation sensitivity for the

LED die is entirely due to and linearly proportional to the current density. This, of course, may not be entirely true, as the conventional wisdom is that there is a lifetime dependence for LED die both from current density and temperature and potentially humidity as well. A controlled study is needed to differentiate between thermal and current density affects and in response, the author hopes to complete such a study in the near future. This also points out that it is critical to establish realistic models and experimental controls for the system level factors that affect lifetime of a LED luminaire when conducting accelerated life studies. The curve used to fit the data for extrapolating life is not necessarily linear either. Thus controls should be put in place to measure the degradation of the LEDs driven at a variety of junction temperatures, current densities, and possibly humidities as well to establish accelerated lifetime models of increased accuracy. Thus, for example, out of the total budget of 30% degradation of initial brightness in 50,000 hours, perhaps only the order of 5% to 15% would be available for the maximum allowable loss due to the polymer optic aging itself.

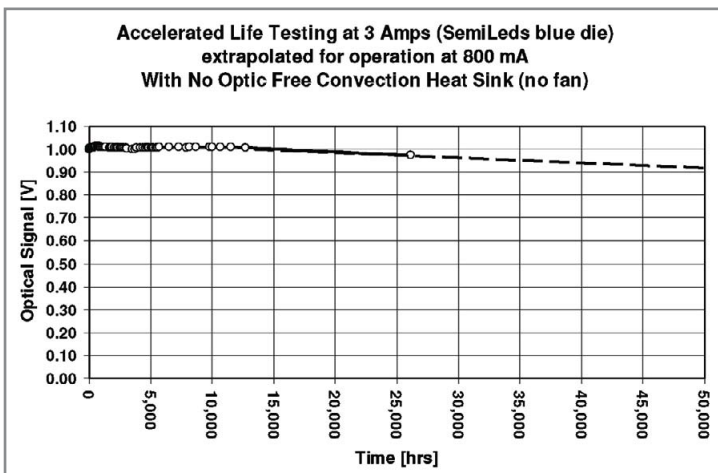

Figure 5: The plot shows the decrease in output with time of a single SemiLEDs blue die at 460 nm when the 3 A data is scaled to what it would be for 800 mA operation assuming linear dependency on current density.

Another consideration when determining reasonable acceleration factors is the affect of the increasing absorption of the polymer with time in the blue spectrum which manifests itself as the observed yellowing with time. At very high flux, this increased absorption can lead to heating of the optical polymer due to the fact that the absorbed energy is converted to heat in the optic, which in turn can play a role in how quickly the optic degrades. For example the aging due to blue flux may occur at a faster rate with increasing temperature. Furthermore, at too high a flux, the increased heat in the optic, which is inherently a poor thermal conductor, can lead to thermal run away and catastrophic failure of the optic. As this was found to be the case in the accelerated lifetime work conducted by Innovations in Optics in 2008, the decision was made for that study to use a current density of 1.0 A/mm² instead of the 3.0 A/mm² described earlier. Thus, the raw data for the luminaire example is shown in Figure 6 for the Bayer LED2045 material. The data shows the real time decrease in blue light emitted for the single 455 nm 42 mil LED die through the collection optic which had an input aperture

area only 10% larger than the LED die itself. An index matching silicone gel was used between the LED die and the LED2045 collection optic to increase the flux into the optic. The loss of light appeared to be linearly related to the integrated flux with time.

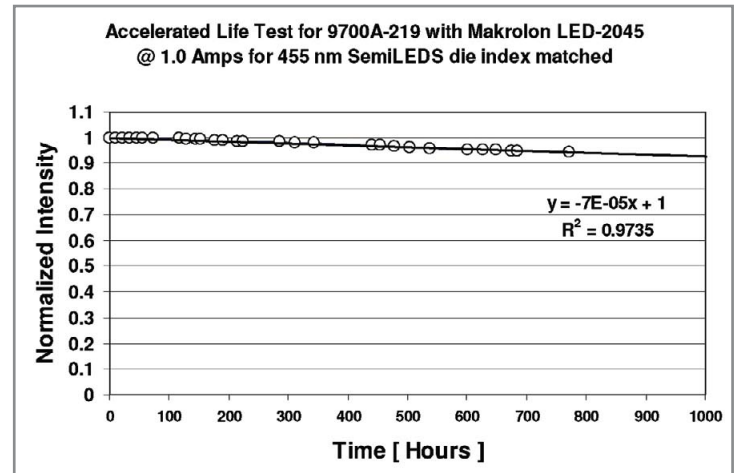

Figure 6: The results of an accelerated life test for Bayer Makrolon LED2045 polycarbonate is shown for operation at a current density of 1.0 A/mm² with index matching gel.

The accelerated aging plots shown above do not tell the complete story. In reality a relatively small portion of the total luminous output from a white LED is affected, as the change in transparency is typically most pronounced in the blue spectral region, but does extend up to the order of 600 nm to some extent. Figure 7 shows a plot of the spectral output of a representative white LED represented by the blue line with a CCT of 5,700 Kelvin as well as its relative lumens contribution in green as affected by the photopic response curve of the human eye as indicated by the red line. Figure 8 shows the same white LED spectrum at 5,700 Kelvin before exposure to prolonged blue light and after exposure as indicated by the red line. The black line shows the change in the transmission spectrum as a ratio of the spectral transmission after exposure divided by the transmission before exposure indicating the significant drop in the blue and blue-green spectrum and little effect in the red.

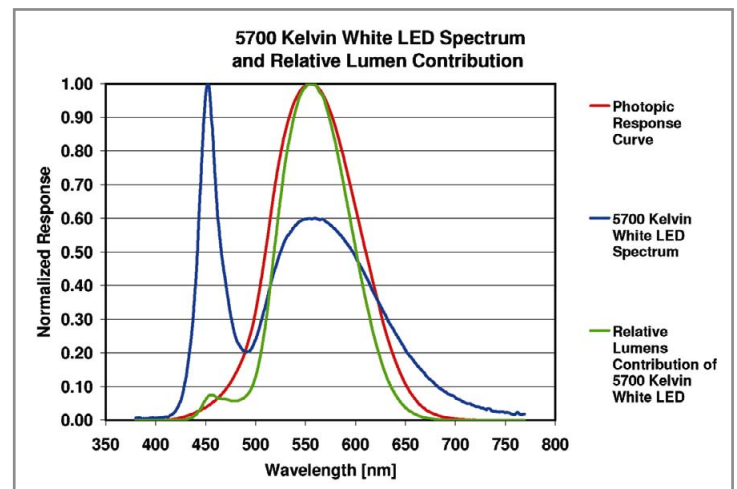

Figure 7: The spectrum of a typical 5700 Kelvin white LED is shown in comparison to its relative lumen contribution as affected by the Photopic Response Curve of the human eye.

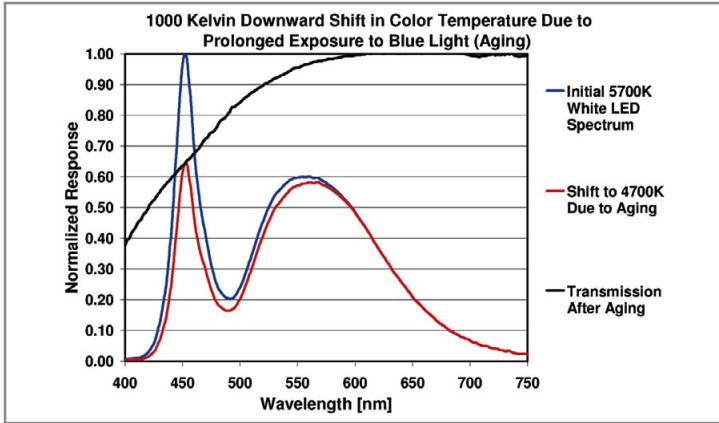

Figure 8: The effect on Color Temperature is shown for an LED luminaire with an initial value of 5700 Kelvin which shifts to 4700 Kelvin due to the yellowing from aging affects upon prolonged exposure to blue LED light.

Of particular note with reference to Figure 8 is the resulting drop in CCT from 5,700 Kelvin before aging to 4700 Kelvin after aging the optical material. This is likely an unacceptable change in CCT for many applications. The problem would be even more acute if the luminaire started off at a lower CCT of around 4,200 Kelvin as the light would become decidedly yellow looking as opposed to white in appearance. If we were to convolve the two spectra in Figure 8 with the photopic response curve of Figure 7 and integrate the total relative lumen output, then we would see that there is only about a 5% change in output due to the significant loss of blue transmission. This relatively small effect is due to the fact that the blue spectrum has very little contribution to the total lumen output, but it does play an important role in color rendering and CCT.

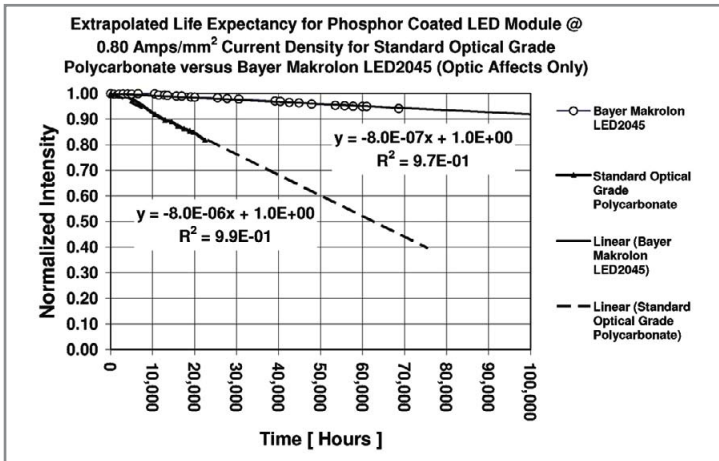

Figure 9: The life expectancy of a phosphor coated LED module operated at 0,80 A/mm² using Bayer Makrolon LED2045 is compared to that of a standard optical grade polycarbonate.

Figure 9 shows the accelerated life data for the LED2045 material taking account of the acceleration factors of 7.3 for the phosphor, 1,8 for the increased flux at 1.0 A above the test conditions of 800 mA, and 1.25 for the fact that the optic used index matching gel between the LED die and the input aperture of the optic, which accounts for the increased extraction efficiency of the LED die due to the presence of the gel. This resulted in an acceleration factor of 10.8 times. An additional factor of 7 results from the spectral affects discussed above which accounts for the fact that lumen output is dominated by longer wavelengths that are not attenuated as

much by aging as is the blue spectral region. Of particular note is that the standard optical polycarbonate still performs well below what is required in comparison to the Bayer Makrolon LED2045 which would result in only the order of 8% drop in lumen output over 100k hours. The life expectancy shown in Figure 9 accounts for only the aging affect of the optic and does not include any other affects such as LED die degradation as discussed previously. If we were to include other system level aging affects, this white luminaire would barely maintain 70% of initial brightness over the course of the 100k hours shown, but would be expected to meet the DOE's goal of 50k hours at greater than 70% initial brightness.

The Need for Accelerated Life Testing Protocol Standards

It follows from the discussion above that there are many aspects of the accelerated life protocols that must be worked out in detail. Specifically, for more comprehensive LED optical material studies in the future, one would have to determine how many of each material to test, what range of discrete current densities, temperatures, and possibly elevated humidity would need to be included and how many and what type of controls should be used. Industry standard test protocols must be developed so that various materials can be compared on an equal basis from different manufacturers. The protocols should also be relevant to the drive conditions of high brightness LEDs. Lifetime data for commercially available optical polymers are typically not provided in a form that is generally useful and applicable to high power and brightness next generation LED luminaires. For example, often the only transmission data available is for very short path lengths on the order of 3 mm or less. Many LED luminaires incorporate polymer optics with significantly longer effective material path lengths, so it would be beneficial to communicate the needs of the SSL community to the polymer optics materials manufacturing community.

Another example of material specifications that are not appropriate to the SSL community is that of the yellowing/aging test protocols. Power densities on the order of 400 mW/cm² are typical for aging studies available from various polymer materials manufacturers. High power and brightness LED modules can expose the primary optics to as much as 500 times that power density. Thus, the aging data is often of little utility. It will take well thought out and communicated studies such as proposed in this effort to educate the materials community as to the needs of the SSL community.

Summary and Conclusions

The importance of primary and secondary optic material selection has been discussed with regard to aging affects that the luminaire designer must be aware of. In particular, the importance of both the decreased lumen output with time and the decrease in color temperature was discussed. The goal of this article was not only to make luminaire designers aware of these issues, but also to bring an awareness of the need for further improvements in optical materials for companies such as Bayer and others that will lead the material development effort toward ever improving LED lighting. ■

International Business Conference LIGHTING KOREA 2009

www.lightingkorea2009.com

12^(Mon) – 13^(Tue) October, 2009

JW MARRIOTT Hotel, Grandballroom,
Seoul, Korea

The 21st century is the age of light.

The 20th century's development of the semiconductor and display industries have promoted the commercialization of LED and OLED which are more friendly to human beings and nature.

The traditional semiconductor and display manufacturing country, Korea, has newly initiated the optoelectronics industry through LED and OLED to nurture the third industry.

Important Dates

Early Bird Registration
2009.06.15 ~ 2009.09.13

Online Registration
2009.09.14 ~ 2009.10.09

Hot Issue

OLED	Chair Dr. Chung, Ho-Kyoon / SAMSUNG SMD	LED	Chair Dr. Yu, Young-Moon / KOPTI
OLED LIGHTING Development of OLED Lighting Technology for Commercial Use / The Future of OLED Lighting		LED LIGHTING Design & Architects / LED Lighting for Commercial Use	
HIGH EFFICIENCY TECHNOLOGY		LED BLU Ultra Slim / Low Cost Issue / Heat management	
MATERIALS High Efficiency & Reliability / High Luminance & Long Life Time / White OLED Development Trend for the Area Lighting		LED CHIP & PACKAGE TECHNOLOGY High Efficiency / High Luminance / Long Life Time	
EQUIPMENT Equipment Development for the Large Area OLED Lighting / Short Tact time for Mass Production		MATERIALS & EQUIPMENT	
LOW COST TECHNOLOGY Roll to Roll Manufacturing Process / Flexible OLED Lighting		NEXT GENERATION TECHNOLOGY	

• SPONSOR

Ministry of Knowledge Economy

• EXHIBITORS

Evans Analytical Group Modistech SungKyunKwan University

• MEDIA SPONSORS

Chungnam Techno Park Display+ Veritas et Visus LED PROFESSIONAL Decotimes OLEDNET
Korea Association for Photonics Industry Development (KAPID)

• SPEAKERS

FEELUX JAPANESE LED ASSOCIATION/PANASONIC SungKyunKwan University TOHOKU DEVICE KITECH
Korea Photonics Technology Institute (KOPTI) EVANS ANALYTICAL GROUP DUPONT GE LIGHTING
Analysis Atelier Corporation NOVALED AG KODAK IDEMITSU KOSAN SFC SUNIC SYSTEM
UNIVERSAL DISPLAY CORPORATION Korea Research Institute of Chemical Technology (KIRCT) MERCK SNU
MODISTECH UBI SANUP RESEARCH

We are looking for the sponsors and exhibitors

INQUIRY Conference general

Ellie Yoon Conference Manager

Tel. +82.2.577.4399 Fax. +82.2.577.4947
E-mail : conference@ubisr.com

INQUIRY Sponsor/ Exhibitions

Hana Lee Marketing & Sales

Tel. +82.2.577.4957 Fax. +82.2.577.4947
E-mail : ubihana@ubisr.com

Shaping the Beam – the Role of Primary and Secondary Optics

Rudi Hechfellner, Director, Technical Solutions, Philips Lumileds and Dave Cohen, Business Unit Manager, Fraen Optical Manufacturing Group

Like all ubiquitous things, the primary and secondary optics in LED lighting systems generally go unremarked and unquestioned. Yet in their different ways, the primary optic [1] and the secondary optic [2] have a huge effect on the light output, reliability, color uniformity and energy efficiency of a luminaire.

This raises an important issue for luminaire manufacturers who use LEDs, for optical engineering is a complex and technical field, and it is hard for the non-specialist to evaluate optics or to know which parameters to examine when considering LED and optical component vendors' offerings.

This article will help by providing a description of the main roles of primary and secondary optics, an outline of how they perform these roles and an explanation of the ways in which optical performance can commonly fall short of the ideal. From this it will be clear that optics are a crucial component in lighting systems, and require precise and skilled design and manufacture. While the most important test of an optic is the performance of the luminaire in which it is used, this article will highlight the importance of evaluating the quality and consistency of LED and optic manufacturers' design and manufacturing processes.

The Role of the Primary Optic

The primary optic on an LED has three, very simple roles to play: to provide refractive index matching to increase extraction efficiency; to provide mechanical protection; and to deliver a uniform beam into the secondary optic. The light at the surface of the LED die is scattered over a wide angle, and unevenly distributed. A well designed, high quality primary optic collects this light and focuses it into an even beam that contains no 'hot spots' of brighter light, and that is balanced evenly across the whole viewing angle.

The design of this primary optic is a key function in LED design, and leading LED manufacturers have specialist optical design teams with responsibility for the task. This is because there is no 'universal' primary optic: both the light-emitting characteristics and the physical dimensions of LEDs from different LED manufacturers are different, and the primary optic must be very tightly matched to both the chip and the package.

Most commonly, the primary optic produces a 'Lambertian' pattern: this is a simple beam, with the light most intense at the centre axis, and growing evenly dimmer as the viewing angle moves away from the centre axis (Figure 1). In the case of Philips Lumileds' LUXEON Rebel LEDs, the light intensity falls to 50% of peak intensity at 60° from the centre axis. Some 90% of the light emitted from the primary optic is emitted within 80° either side of the centre axis.

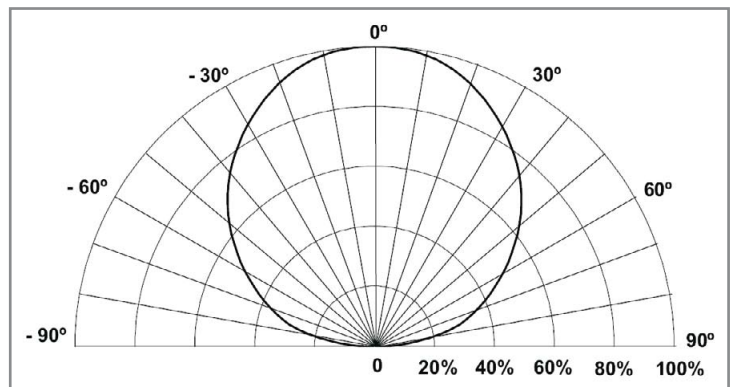
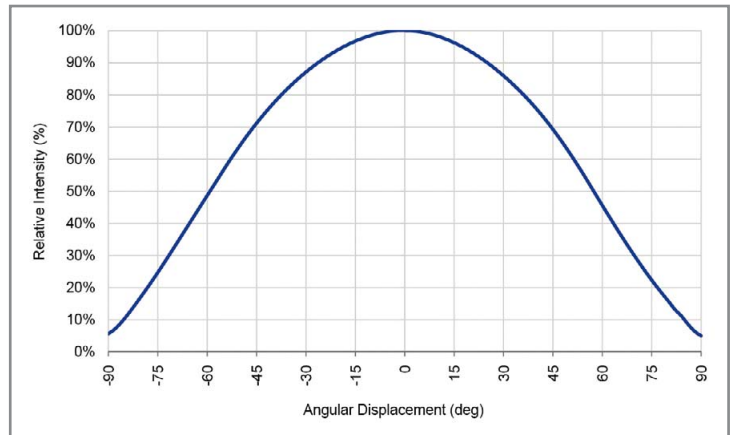

Figure 1: Typical radiation patterns for Lambertian beam from a datasheet [3].

A perfectly even, uniform Lambertian-pattern beam is the easiest for secondary optics manufacturers to collect and manipulate; what this means for the luminaire manufacturer is that the best optical results – at the level of the luminaire, after light is emitted from the secondary optic – are likely to come from LEDs that come closest to delivering a perfectly even beam.

Every luminaire manufacturer should therefore carefully examine the photometric data (as in Figure 1) from competing LED suppliers to uncover any differences in output. A Lambertian beam output should be symmetrical and show a smooth reduction in intensity, with no large steps, from the centre axis out to the edge of the beam.

Factors Affecting Quality of Output from Primary Optic

Interestingly, the primary optic is actually not the critical element in delivering a uniform beam. Far more important is the light source itself, and the phosphor coating over the light source responsible for conditioning the chromaticity of the output. In particular, traditional 'crystal deposition' methods used by some LED manufacturers to apply a phosphor coating to the surface of the LED have been responsible for uneven, spotty inputs to the primary optic. Given that this unevenness is inconsistent from one LED to the next, it cannot be compensated for by a mass-manufactured primary optic. As a result, the uneven, spotty input produces an uneven, spotty output from the primary optic.

It was to address this problem that Philips Lumileds introduced its conformal phosphor coating process, which other manufacturers have adopted, and in 2007 its Lumiramic phosphor technology, a ceramic phosphor plate of uniform and known thickness across the whole light-emitting surface of the LED. These solutions virtually eliminate the unevenness associated with crystal deposition, and are responsible for the ability of the LUXEON Rebel LED to deliver the smooth light output illustrated in Figure 1.

It is also true that a poorly manufactured or assembled primary optic will fail to deliver a consistent and even output. Impurities in the material used in the optic or a failure to position the centre axis of the optic correctly over the centre of the light source could both affect the LED's performance. 'Typical' performance will be clearly stated in the datasheet for every LED, but, as so often in life, it is a case of 'caveat emptor': the buyer must decide for themselves whether they have faith in the quality of design and manufacturing of the LED supplier, and therefore whether the 'typical' performance quoted in the datasheet will be borne out in reality with a very high degree of consistency.

The experience of secondary optics manufacturers, which pay extremely close attention to LED optical performance, shows that the photometric data supplied by the best-known LED vendors closely matches real-world performance.

Indeed, the leading manufacturers of power LEDs maintain close relationships with secondary optics manufacturers, and solicit their feedback during product development. Before any new LED device is released for mass production, it is ensured that the output from its primary optic is optimised for manipulation by secondary optics.

Role of Secondary Optic

We have shown, then, how a primary optic works to deliver a uniform beam with a wide viewing angle and with a shallow peak in intensity at the centre axis.

The role of the secondary optic, then, is equally simple to describe: it is to collect the beam pattern and flux from the primary optic, and manipulate it to deliver the correct light pattern and illuminance (measured in lux) into the correct space.

This is simple to describe, but extremely technically hard to accomplish, and this is why specialist optic manufacturers have become a crucial part of the LED lighting supply chain.

It is true that in certain simple and low-cost LED lighting devices, as is the case with hand torches, a simple reflector will suffice. In these applications, there is not always a requirement for a specific pattern or light distribution – although specialised and high-end torches do have such requirements. The reflector can be integrated into the housing, without a specialist secondary optic, in order to meet the extremely competitive parts and manufacturing cost targets for such simple devices.

Technical Challenges in Delivering Correct Illuminance and Light Pattern

But most lighting applications have a specific function that requires a specific light distribution, and this is where the secondary optic becomes a crucial component. This is best explained by way of an example such as street lighting. For reasons of safety and civic amenity, street lamps have to deliver a fixed minimum amount of light into a fixed minimum area. At the same time, legacy infrastructure – poles – impose a requirement for fixed light patterns, in order that lamps at a fixed height and a fixed distance apart can deliver the specified ground illuminance (measured in lux). Industry specifications also impose a requirement to avoid both light pollution and glare – requirements that a combination of LED light sources and secondary optics are very good at meeting.

These specifications are codified differently around the world; street lamp manufacturers have to comply with street lighting standards that are different in Europe from those applied in North America, for instance.

It is the secondary optic that enables the luminaire manufacturer to achieve compliance. For example, in early 2009 Fraen developed a standard secondary optic for LUXEON Rebel LEDs that delivers a light pattern compliant with IESNA II and IESNA III street lighting standards for North America, and with Europe's ENI 13201 S and CE standards. This design has been adopted by a number of lighting manufacturers including Bluespan, which has installed its street lights in numerous cities in Portugal.



Figure 2: Bluespan street lamp used in Portuguese municipalities.

As well as delivering optical solutions for industry standards, secondary optic vendors can also develop and manufacture optics to meet pattern and lux requirements specified by the luminaire manufacturer itself. The optical engineering and precision manufacturing skills required for this task are of a very high order, particularly when the application – highway lighting is a good example – call for the distribution of a high-intensity beam in a very tightly defined area from an extremely long distance (highway lights are mounted on very high poles).

To meet the precise beam-shaping requirements of most applications, then, secondary optics must offer extremely high performance. We have already shown how the quality of the output from the primary optic strongly affects the ability of the secondary optic manufacturer to deliver a high-quality output.

A related but separate point is that secondary optics must be optimised for specific LEDs. It is true that LEDs from different manufacturers will both produce a Lambertian output. But there are ways in which the light to be collected by the secondary optic will be different. The LEDs might have:

- Different physical dimensions
- A different distribution of light within the framework of a Lambertian pattern, such as narrower or wider FWHM (Full Width Half Maximum) viewing angle, or a different peak-to-trough brightness ratio

This is why the secondary optics from most suppliers are listed for use with specific LED brands. They are designed to be mounted perfectly over the centre axis of the primary optic, and to collect optimally the exact pattern of light produced by that primary optic.

One-size-fits-all optics are available on the market, and they can clearly offer a cost advantage because of economies of scale, but performance will necessarily be compromised.

To take this same point in the opposite direction, it is interesting to ask whether optical performance would be improved if primary optics were eradicated and all light collection and manipulation were performed by a solo application-optimised optic.

This is in fact what happens in a small number of very high volume applications, such as the camera flash in mobile phones. Here, the volumes merit the development of customer-specific LEDs that can be supplied with a single optic.

For general use, however, customers require a uniform output from LED manufacturers that can be clearly stated in a datasheet and matched by the performance of the manufactured product. The scattered and uneven output from the raw LED light source would not meet this requirement for uniformity, which can only be achieved by the implementation of a primary optic.

In pure optical terms, however, it would be preferable to eliminate the primary optic. This is because light is lost as it crosses from one medium (the primary optic) to another (the secondary optic). This phenomenon is particularly marked in applications that require a narrow beam.

Optical science, then, calls for single optics, but the commercial reality of LED manufacturing means that systems will continue to be comprised of both primary and secondary optics.

Optical Output Set to Improve as Technology Develops

In any case, solid-state technology is pushing more and more into illumination application markets, since it already comfortably outperforms traditional light sources in terms of efficiency and reliability.

What is more, the prospects for improvement in the optical quality of solid-state lighting systems are good. In the field of secondary optics in particular, advances in materials technology promise to deliver optical performance as good as today's devices but at lower materials and manufacturing cost – a response to the intense pricing pressure on many parts of the lighting value chain. ■

References:

[1] The transparent dome covering the light-emitting region on the top surface of an LED, an integral part of an LED device

[2] The lens or reflector mounted on top of the LED and within the body of the luminaire itself, manufactured and marketed separately from the LED

[3] Philips Lumileds, datasheet for LUXEON Rebel LED

Save Space with Focus Tunable Lenses

> Mark Blum, MSc EE, Manuel Aschwanden, PhD, David Niederer, MSc ME, ETH, Optotune

Adaptive optical elements are of great importance in a wide range of industrial, medical and scientific applications. For instance, shape changing diffraction gratings are used as compact optical switches in communication systems and displays. Other examples include liquid crystal displays and spatial light modulators. Additionally, acousto-optic modulators are used in optical microscopes to adjust the intensity of the illumination laser light.

This article is centered on a very recent development in adaptive optical elements: focus tunable lenses. Today, the major shortcomings of optical focus and zoom systems are size and cost. Applications are countless: low-cost compact camera modules for mobile phones, focusing features in endoscopes or less bulky and heavy optics in microscopes to name a few. Next to these imaging systems, adaptive lighting is a further interesting application.

There are two principle approaches to focus tunable lenses. The first is based on local changes in refractive index that enable the implementation of a Fresnel lens. These changes can be induced by an electro-optic or acousto-optic effect (Figure 1). The most popular technology for this approach is liquid crystals, with the advantage of low drive voltage ($\sim 10 V_{rms}$), small power dissipation and ease of miniaturization. However, liquid crystals are sensitive to polarization, slow in response due to reordering of molecules and low in optical damage threshold (up to 2 kW/cm^2).

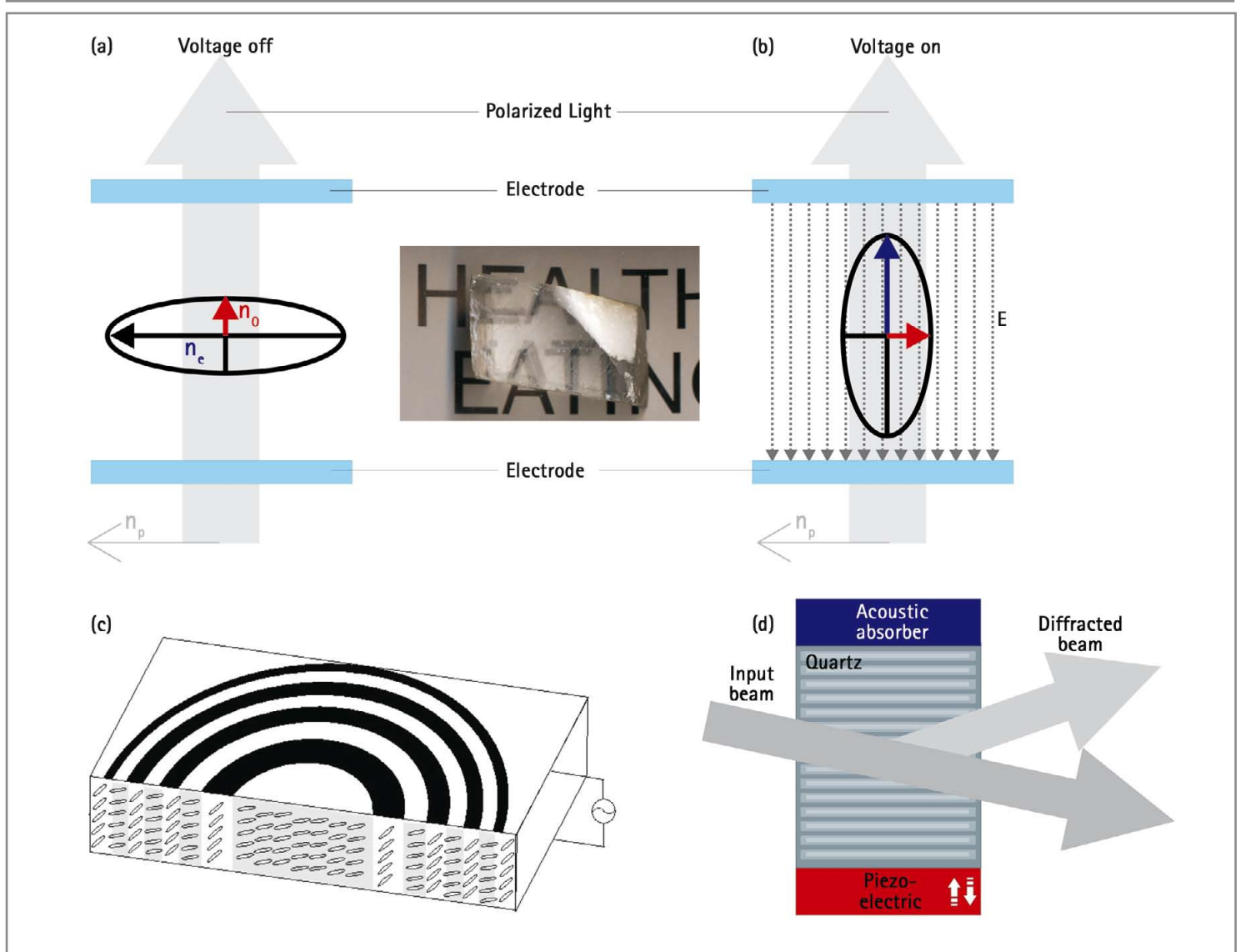

Figure 1: (a) Birefringent molecule of a nematic liquid crystal in its predefined orientation. (b) Rotated molecule when an electric field is applied. (c) Schematic of a tunable Fresnel lens based on liquid crystals. (d) Schematic of the principle operation of acousto-optic modulators. A piezo-electric transducer creates a sound wave that moves in a transparent optical material like quartz. The ultrasonic wave induces local strains causing a change of the material's refractive index, creating a diffraction grating. An acoustic absorber prevents reflection of the sound wave.

The second approach is to control the shape of a lens, which results in better quality, higher tuning range, no polarization dependence. A heavily researched lens technology is based on the electrowetting effect (Figure 2). Advantages of this technology are low power consumption, medium tuning range and inexpensive fabrication. The main drawbacks are the limited aperture size of about 3mm due to the domination of gravity over capillary forces in larger systems.

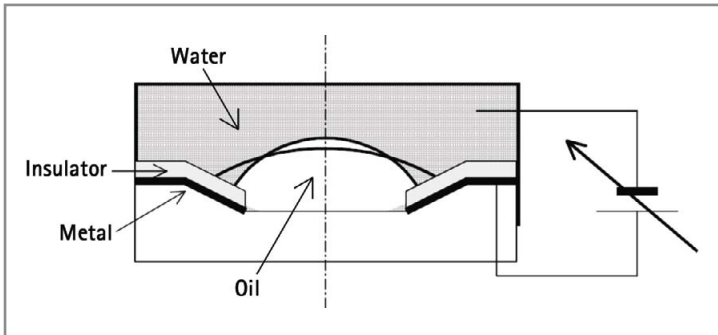

Figure 2: A liquid droplet is deposited on an insulated metal structure. The contact angle and consequently the curvature of the droplet can be changed by varying the voltage applied to the substrate.

Optotune, a spin-off of ETH Zurich, has developed a focus tunable lens based on electro-active polymers (EAP), so called artificial muscles. A thin polymer membrane builds the interface between two chambers each containing an optically clear material, with different refractive index. The pressure difference between the two chambers defines the deflection and with that the radius of the lens. The pressure difference can be controlled with the ring-shaped actuator.

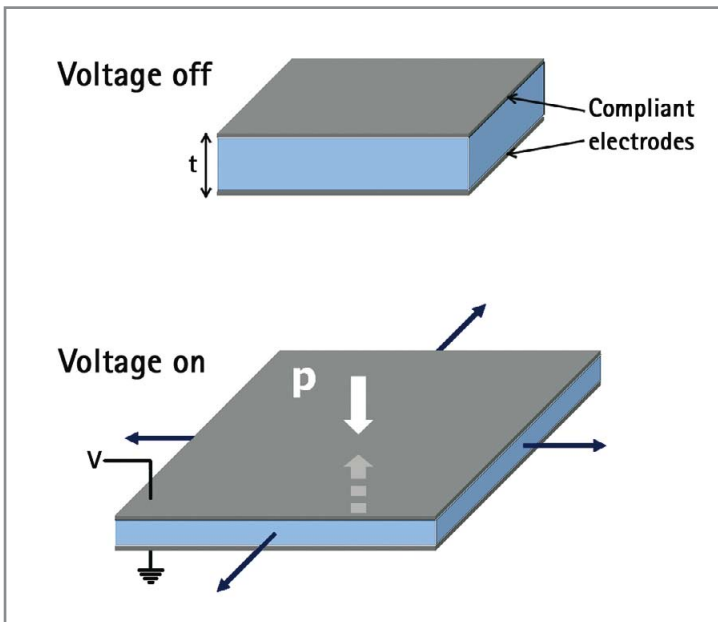

Figure 3: Working principle of dielectric elastomer actuators (DEA), the most commonly used form of electroactive polymers (EAP). With increasing voltage applied the electrostatic force works against the internal material strain and makes the polymer membrane expand (up to 40%).

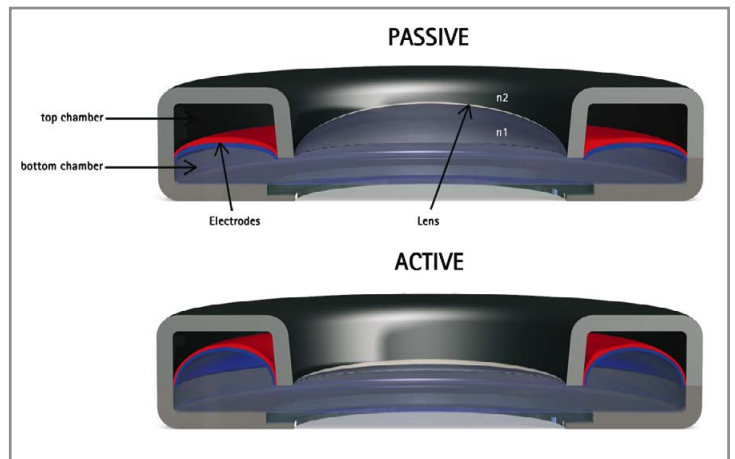

Figure 4: Schematic of a lens design based on artificial muscles. The bottom chamber is filled with an optically clear material of refractive index n_1 , the top chamber with an optically clear material of refractive index n_2 (e.g. air). Separating the two chambers is a membrane, which is carrying ring-shaped artificial muscles on the outside. As the bottom chamber is under higher pressure, the lens deflection decreases when the artificial muscles are used to relax the membrane on the outer ring. With $n_1 > n_2$ the result is a plan-convex lens, which increases its focal distance with increasing actuation of the EAP.

By controlling the mechanical properties of the membrane, different lens shapes can be achieved (from spherical to parabolic). Table 1 contains the characteristics of the latest lens design.

Mechanical Characteristics	
Width x Depth x Height	12 x 12 x 3.7 mm
Clear Aperture	2.4 mm
Optical Characteristics	
Focal Tuning Range	3.5 to +100 mm
Wavelength Range	380 – 1000 nm
Transmission @ 532 nm	> 96%
Refractive index	1.56
Abbe number	31
Lens shape	Plane-Spherical
Electrical Characteristics	
Input Voltage	0-5 V
Cycle Life	>10,000,000
Frequency Response	90% range @ 50 Hz 10% range @ 200 Hz
Thermal Characteristics	
Storing Temperature	-40 to 100°C
Operating Temperature	-20 to 85°C

Table 1: Characteristics of the EL-3-12 focus tunable lens.

In general, lens aperture and thickness can be varied from sub millimeters to several centimeters. The focal tuning range can be designed according to application requirements. However, there is always a trade-off between size, tuning range and response time.

Constant Current LED-Drivers

DC/DC-Drivers for LED's

If you want to drive your LED-Array from DC sources, RECOM has the perfect Plug & Play solution! We offer constant current up to 1.2A that will make your LED's shine with uniform color and intensity.

An efficiency of up to 98% guarantees reliable operation at very high ambient temperatures of up to +85°C without any derating!

SPECIFICATIONS:

Input: 4.5V to 36V

Output: 2V to 36V

Output Current: 300mA to 1.2A

Output Current Acc.: +/- 2% typ

Temperature Coeff.: 0.015%/°K

Ripple/Noise: <120mVpp

Operating Temp.: -40°C to +85°C

Analogue and PWM dimming



RECOM Electronic GmbH
Phone +49 (6103)-30007-0
info@recom-electronic.com
www.recom-electronic.com



Figure 5: The focus tunable lenses with apertures ranging from 2.4mm to 16mm.

The biggest advantage of the lenses is the additional degree of freedom offered to optics designers by the focus tunability of the lens. Optical systems can be designed more compact with less lenses and less or no translational movement. This means that there is no more need for expensive mechanical actuators. Also, the components of the lens can be manufactured at low cost, making this technology suitable for consumer applications. Less movement also leads to a more robust design, which is completely closed so that no dust can enter. Less movement generally also means less power consumption. A change in lens radius of several micrometers can have the same optical effect as moving the entire lens several centimeters. Finally, the materials employed are all lighter than glass, saving overall weight.

There are also downsides to this approach. As the lens consists of soft materials, there is a gravitational effect which creates a small coma when the lens is in vertical position. The coma can be reduced by building smaller lenses and using stiffer materials. The latter, however, has a negative impact on tuning range and power consumption.

In addition, depending on the materials used, a thermal expansion can be observed, which has an influence on the lens radius. This can be an issue in open loop systems.

The areas of application can be categorized in three groups: Lighting systems, imaging systems and laser applications. Examples for the first group are flashlights, spot lights, automotive headlights and illumination systems for microscopes. These applications are most forgiving in terms of optical quality, but they can be very challenging in terms of environmental conditions. Spot control is likely to become a very sought for application for tunable lenses. Halogen lights, which emit light radially, can be focused using a parabolic mirror. LEDs, on the other hand, emit mainly in one direction, requesting new optics for spot control.

The group of imaging systems includes cameras of all sorts, microscopes, endoscopes, binoculars and telescopes among others. Focus tunable lenses are particularly interesting for applications with tough space requirements (e.g. camera phones) or where fast focusing is required (e.g. computer vision). Examples for laser applications are bar code reading, laser cutting and beam control in general.

Apart from tunable lenses, Optotune has developed two additional products based on artificial muscles. By placing the transmissive phase shifter into the path of a laser beam, the phase of the laser can be controlled by varying the thickness of a membrane with a control voltage. This simplifies the setup for interferometers and helps increase the resolution of HELM-microscopy. The other product is called a transmissive speckle reducing diffuser. By moving a thin diffusing membrane in the path of a laser at >50 Hz laser speckles are reduced. The result is a sharper and less noisy image in laser projection or higher resolution in computer vision based metrology. ■

Parameters to Consider for LED Optics Design

> Guido Campadelli, EU Sales Manager, Fraen Corporation

To create an optical system it is important to analyze the characteristic of the source: The best approach is to design the solutions specifically on each power LED using the related ray-set and managed through complex software as the starting point of any developments.

To understand the problems of optics design for LED systems completely, it is necessary to understand the most important parameters used for evaluation of an optic system:

Optical Efficiency

The optical efficiency is expressed in candelas per lumens (cd/lm) and is an easy way to indicate how many candelas can replicate the optics for every single lumen emitted by the LED source. This is very important because a simple efficiency parameter expressed in percentage can be interpreted in different ways.

Divergence

The divergence is expressed as Full Width Half Maximum (FWHM but considering): For FWHM, it is taken into account that the human eye has a logarithmic perception. Because of this value, an optical system is not completely defined; in most cases, the FW10% M should be considered a useful divergence: FW10%M means Full Width at 10% Maximum.

Efficiency

Efficiency is the ratio between the light measured after the optics and the light of the sole LED:

$$\text{Eff} = L_{\text{out}} / L_{\text{in}}$$

Luminous intensity

To roughly calculate the on-axis luminous intensity "I" – expressed in candela – of an optic system, the following formula is used:

$$I = F * \text{Eff}$$

where F is the typical luminous flux expressed in lumen indicated in any LED datasheet.

Illuminance

To calculate the illuminance "J" expressed in lux at a specific distance "D" expressed in meters, the following formula is used:

$$J = (F * \text{Eff}) / D^2$$

With these parameters the most important properties of optical systems are described and different optical solutions can be compared.

Design-Challenges and Optical Solutions for LED Lighting Systems

In general, TIR optics (total internal reflection optics) are the preferable optical solution indicated for LED sources with a small and well defined focal point of 0.7x0.7 mm to 1.0x1.0 mm dies (Figure 1a). The TIR optics has the advantage to manage the direct and the reflected light, and with the same dimension, simply changing the top micro-lens allows the generation of different beam patterns.

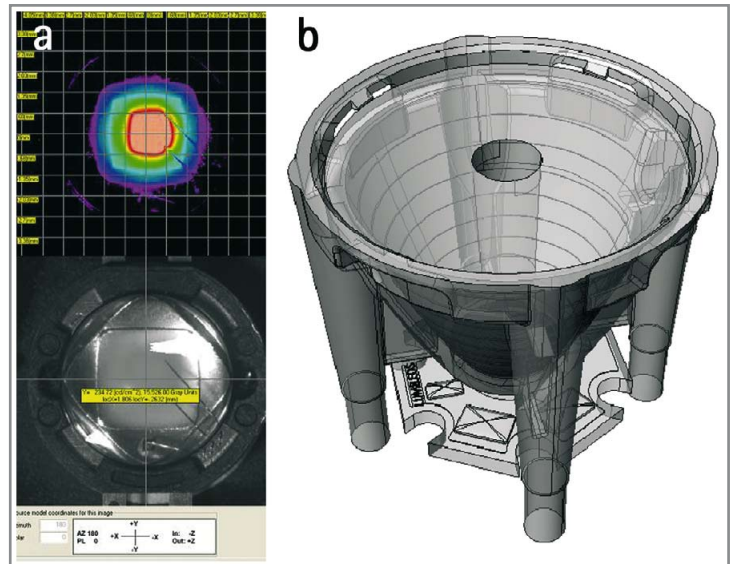

Figure 1: 1mm² LED radiation characteristics (a) and appropriate optics (b).

The main design-challenge is to achieve the higher on-axis efficiency and narrower beam pattern (Figure 1b). Then, the second step can be performed: increasing the divergence to obtain a various family range. Hereby narrow usually defines divergences between 6-12° (Figure 2a), medium between 18-28° (Figure 2b), wide between 30-45° (Figure 2c), and elliptical between 8-30°x20°-80° (Figure 2d).

The size of the optics has an impact on lighting quality too, not so much on the total efficiency but mostly on the control of the light: bigger optics helps to target more light in the useful field. As can be seen in Table 1, efficiency just falls by 5% from the biggest to the smallest lens while the optical efficiency decreases to one-fourth of the value of the 35 mm lens.

Diameter	Total Efficiency	cd/lm
20 mm	85%	20
27 mm	88%	35
35 mm	90%	80

Table 1: Total efficiency and cd/lm for the different sizes of standard solutions.

Based on a widespread experience, only the best balance of optical development, tooling, engineering and cycle timing allows attaining the best efficiency to size ratio. The values of Table 1 are representing top performance for the particular size, for instance with a 35 mm optics and a 1 mm² die it is possible to reach 90% efficiency and 80 cd/lm.

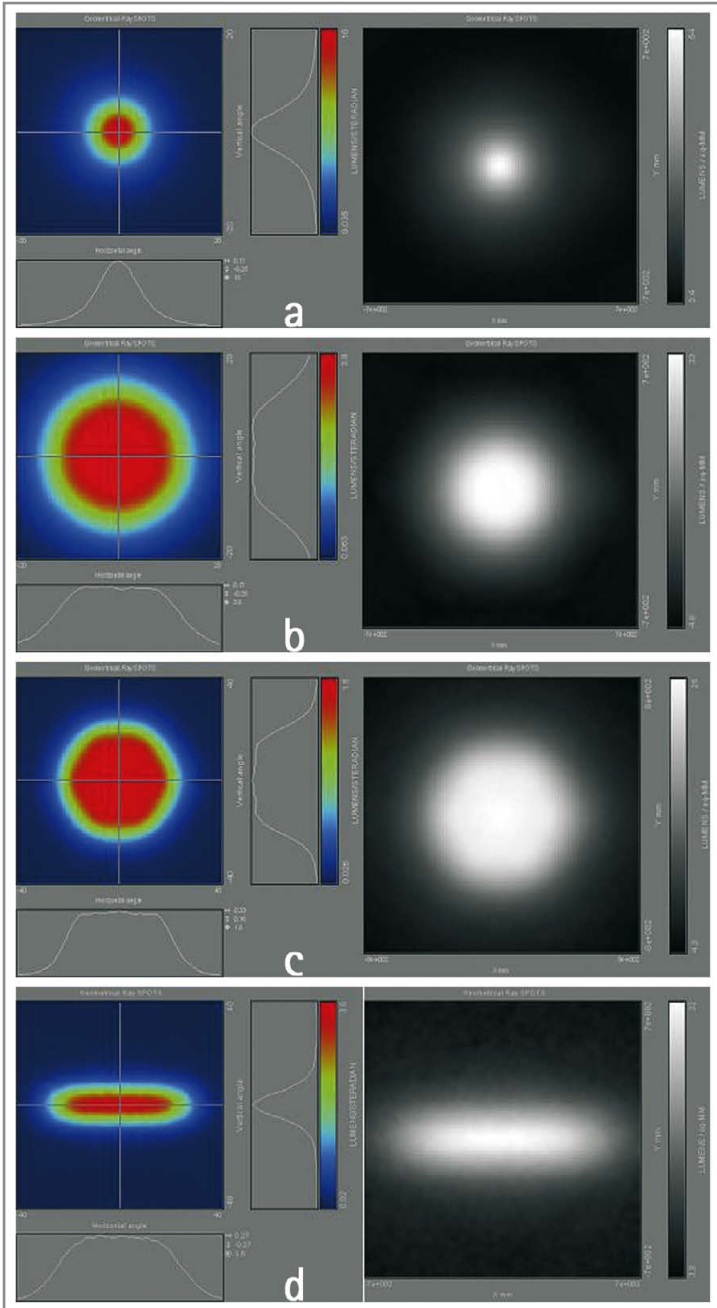

Figure 2: Divergences of an optics "family" from narrow = 6-12° (a), medium = 18-28° (b), wide = 30-45° (c), and Elliptical = 8-30°x20°-80° (d).

There is a limit of divergence in either case of about 50° for this kind of system. Beyond this limit it is not convenient, because the physical losses grow rapidly when increasing the angle. Like for all developments, the goal has to be to find the best compromise of efficiency and quality beam pattern, and therefore alternative solutions are preferable over TIR systems.

Also for developments for single die LED over the "limit" of 50° - e.g. downlights - reflector systems can be a good solution that, in addition, reduces also the glare effect dramatically. In this case instead of TIR solutions the multi-faceted technology can be combined with high reflectance aluminum coating to obtain the desired high-system performance.

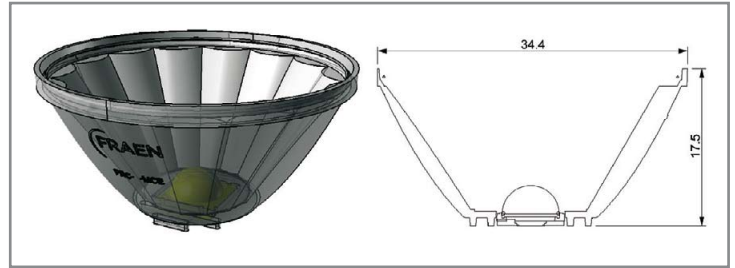

Figure 3: Reflector design for multi-chip LEDs.

There is another reason and more classical application issue for using reflector systems. Multi-Chip LEDs, today becoming more popular and reaching 1,000 lm of total emission with dies dimensions of about 10 mm². They have different emission characteristics and can be better managed trough reflectors (Figure 3).

Optics Materials

In general, there are two materials that are used in high quality products today; PMMA and Polycarbonate. The preference of the PMMA as material is because of the higher transmittance compared to the Polycarbonate. But there is also one disadvantage; the temperature limit up to 90° C could be critical in some applications. Hence a proper thermal design is necessary, which should be self-evident for each high-quality LED lighting product because of efficacy and lifetime issues.

The molding technology, used for TIR optics, is plastic injection and laser cut with automated lines. For the reflector solutions follow additional processes; one or two aluminum coating phases and a coating process with anti-oxidations.

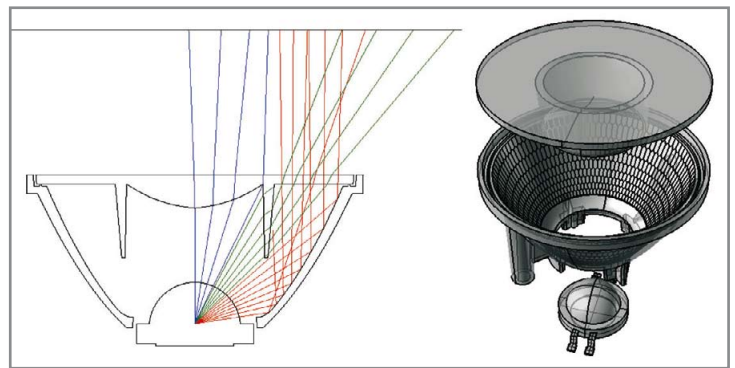

Figure 4: Hybrid solution between TIR and reflector design.

Conclusion

Different solutions are advantageous for different applications, especially regarding divergence and die size of the applied LED. Hence an optical solution provider has to choose the appropriate technology. Therefore Fraen is expanding the ability to develop hybrid solutions that can be defined as the compromise between TIR and reflector advantages. This solution especially allows for specific designs or customized projects (Figure 4). ■

LED professional – Patent Report

> Siegfried Luger and Arno Grabher-Meyer, Editors, LED professional

Intellectual Properties play an important role in the still young and highly dynamic LED area. The number of patent applications and granted patents is continuously increasing and it's difficult to have the overview. Therefore, LED professional publishes the bi-monthly "*LED professional - Patent Report*", which is released in conjunction with the *LED professional Reviews*. The report covers the US & EP granted patents in the field of LED lighting for the last two-month period. Every granted patent is highlighted with: a selected drawing (Derwent), the original patent title, a specifically re-written title (Derwent), the IPC class, the assignee/applicant, the publication number and date, and last but not least the original abstract.

With the "*LED professional - Patent Report*" it's convenient to screen the IP-landscape, to prove the "freedom-to-operate", to check for a needed opposition, to monitor the competition or even to get inspirations for own inventions.

LED professional – Patent Report (LpR 15)

Period: July 1, 2009 – August 31, 2009

Regions: US & EU

Application: General Lighting

Granted Patents: 159

Pages: 79

The LED professional – Patent Report is only available for *LED professional Review (LpR)* digital subscribers. If you have a valid subscription, please download the report by following this link: "[LED professional – Patent Report \(LpR 15\)](#)".

To order or renew your digital subscription: Click [here](#) or see <http://www.led-professional-review.com>.

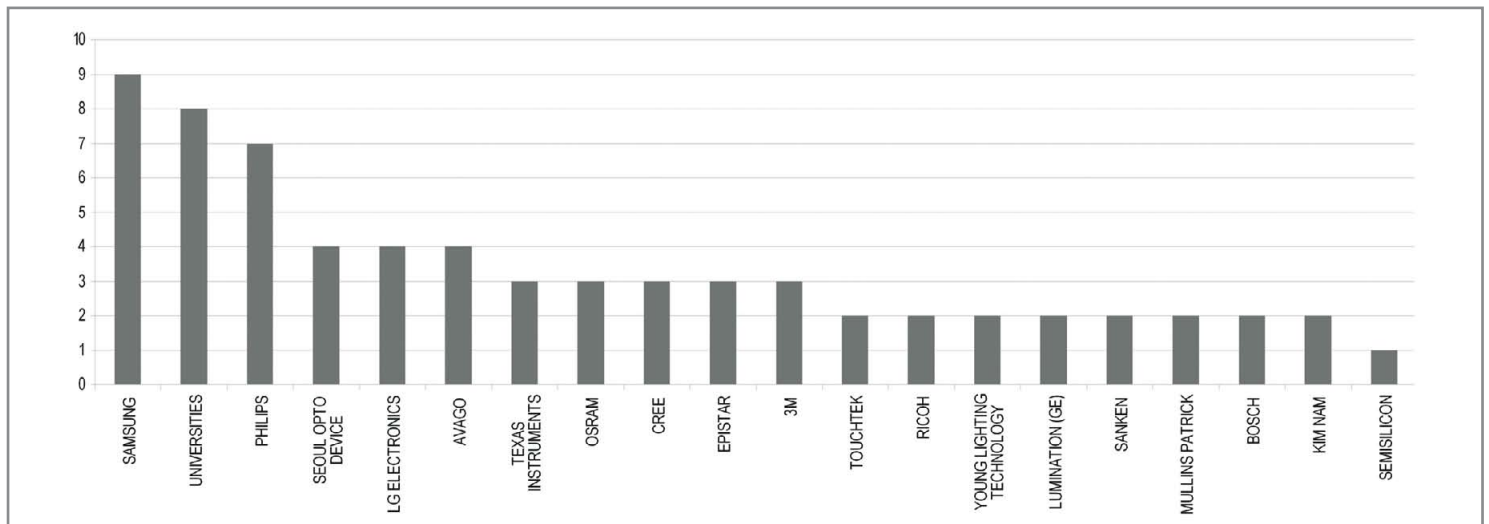

Number of granted patents vs. Top20 assignees.

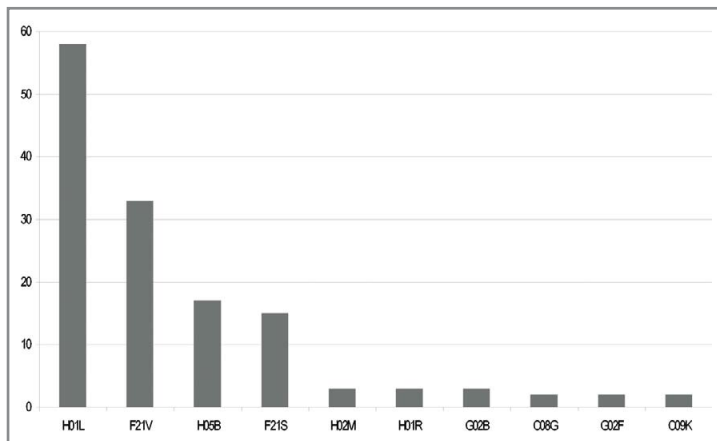

Number of granted patents vs. IPC classes.

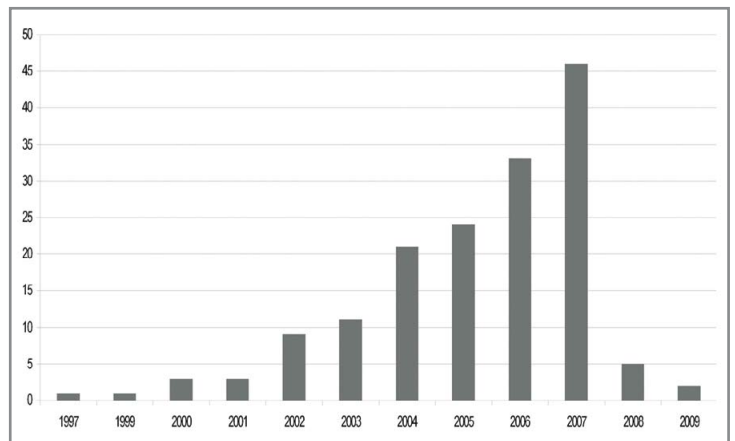

Number of granted patents vs. priority years.

Lighting Quality & Energy Efficiency

March 14–17, 2010
Vienna, Austria

Highlights:

- Surveys of experimental projects
- Lighting techniques & scenarios
- Integrated approaches in Lighting Design
- Lighting quality criteria
- Future possible lighting schemes
- Methods to compare lighting installations
- Case studies of energy-efficient lighting
- Review of energy-efficient lighting control systems
- Energy efficiency & environmental compatibility

<http://vienna2010.cie.co.at>

For further information please contact:
CIE Central Bureau, Kegelgasse 27/3, 1030 Vienna, Austria
Phone: +43-(0)-1-714 31 87, Fax: +43-(0)-1-714 31 87-18
Email: vienna2010@cie.co.at

Arrow and Lightech join forces



Arrow's extensive LED lighting linecard has been further enhanced with the addition of Lightech Inc, a global specialist in state of the art Lighting Power Supplies.

Lightech's product range includes the widest variety of electronic transformers currently available on the market, with universal voltage input LED converters featuring constant current or constant voltage output versions, alongside their compact HID ballasts.

Our lighting customers can now benefit from a true 'one-stop-shop' for all Solid State Lighting requirements. Our extensive lighting linecard is backed by flexible purchasing solutions and technical support services, saving you time and money through all stages of product development and manufacture.

Contact us with your requirements for LEDs and Drivers, or design support through:

www.arrowne.com/lighting

Non-UK customers can check our local office:

www.arrow.com/business-with-arrow.emeasa.html



TEL 01279 626 777

FAX 01279 455 777

E-MAIL ADVANTAGE@ARROWUK.COM

• Semiconductor

• Passive

• E-Mech

• Interconnect

• Industrial Computing

• Wireless

• Display

• OS

ARROW

ARROW ELECTRONICS UK LTD

LIGHTECH
WWW.LIGHTECHINC.COM