

## Display

RIGOL STOP

### LED Testing & Manufacturing

Costs for HB-LED Manufacturing

Safety Regulations

Light Measurement

LEDs Thermal Resistance

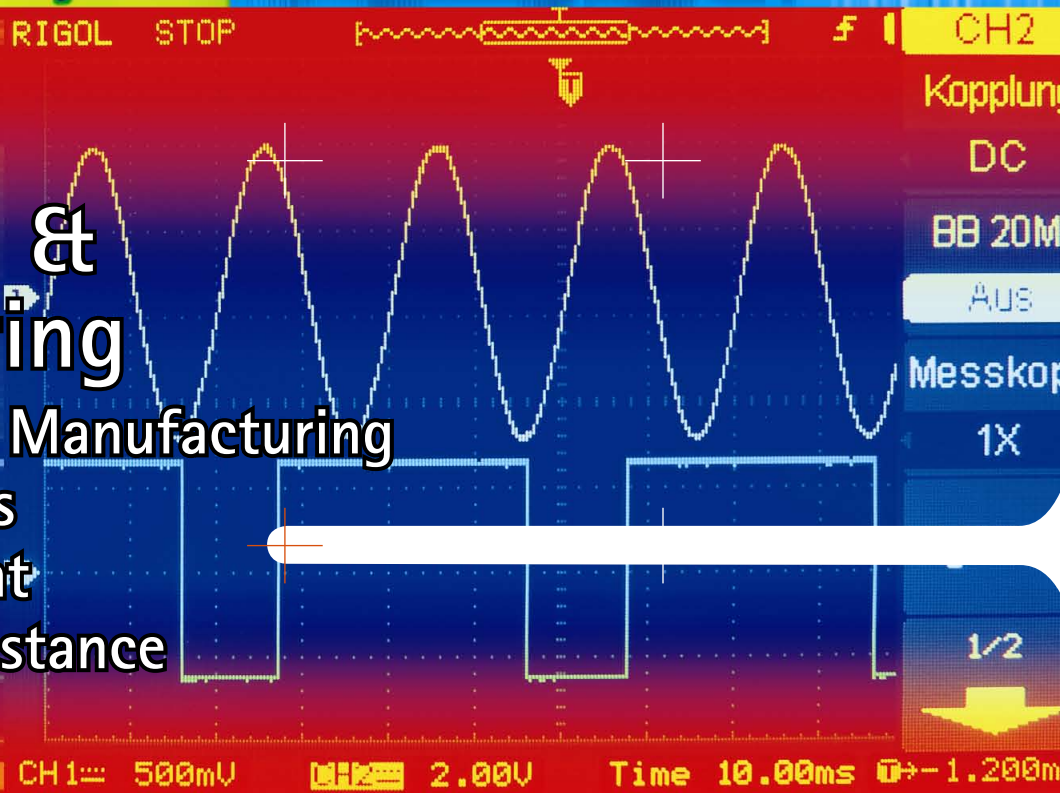

STOP

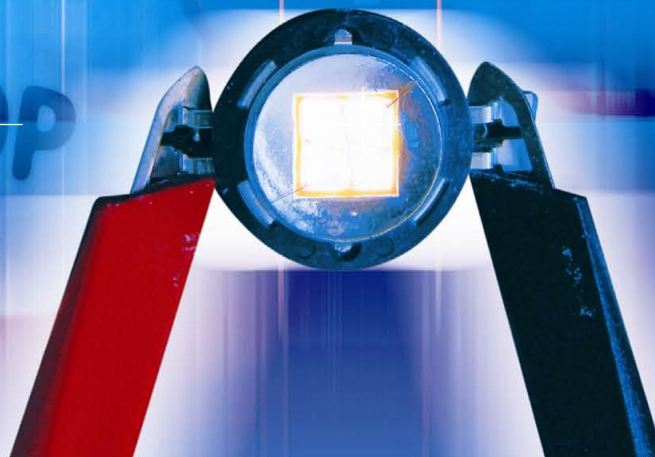

We bring quality to light.

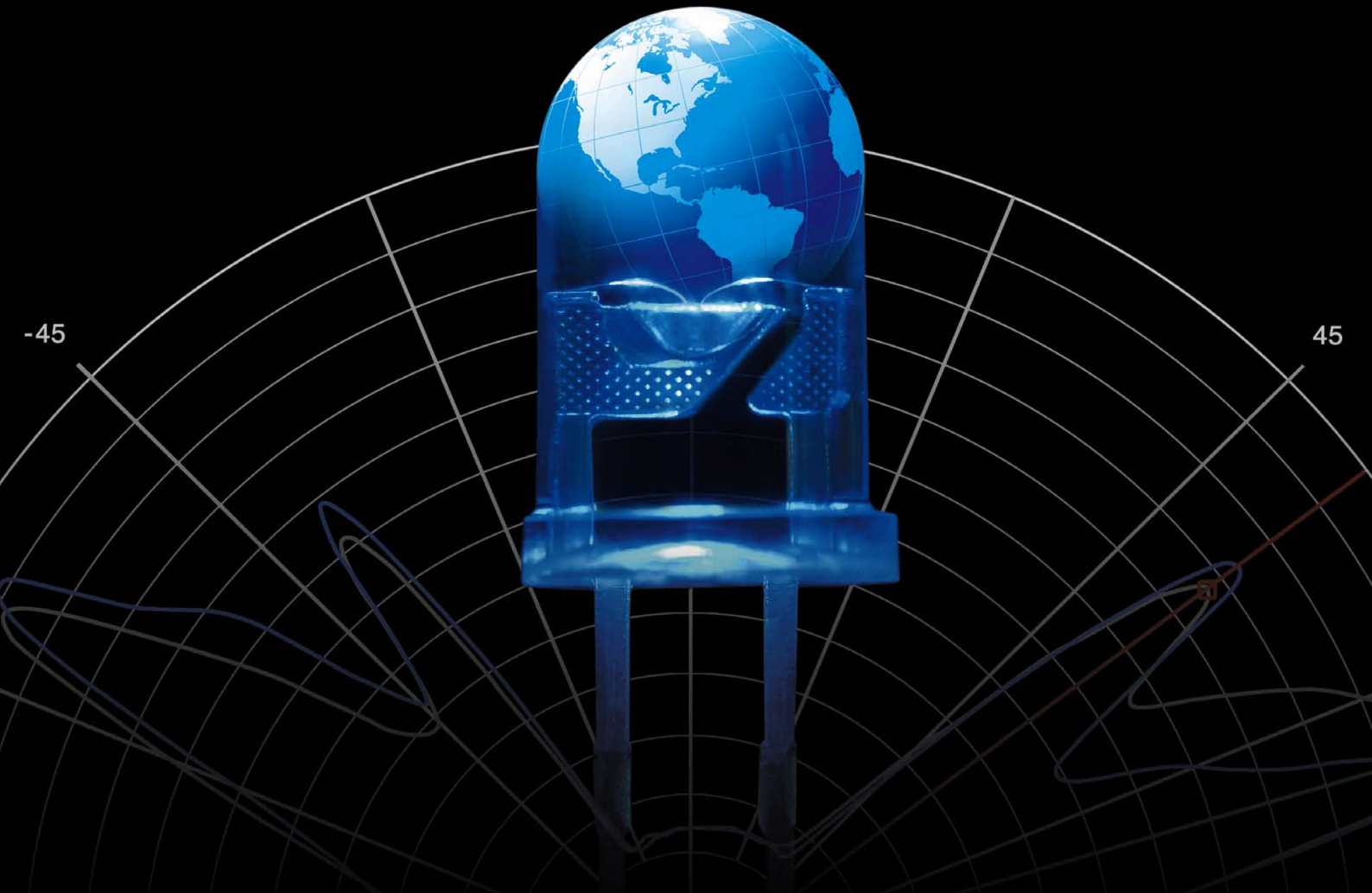

## LED test & measurement solutions from the world leader

Instrument Systems continues to set the benchmark in LED metrology. Whether testing individual LEDs (standard or high-power), LED modules, or OLEDs - the global LED industry relies on us to engineer superior measurement equipment for high-speed production testing and high-performance R&D and QC applications.



### **Our instruments provide accurate and reliable results as per CIE recommendations and methods:**

- Luminous flux [lm], luminous intensity [cd], and luminance [cd/m<sup>2</sup>]
- Chromaticity coordinates x,y,z and u'v'
- Color temperature and color rendering index
- Dominant wavelength and spectral data
- Spatial radiation pattern

 **Instrument  
Systems**  
light measurement

## Stimulating Markets



The L Prize competition, performed through the U.S. Department of Energy, is the first government sponsored technology competition designed to spur development of ultra-efficient solid-state lighting products to replace the common light bulb. The prize is dedicated to the winners for new technology products replacing the inefficient 60W incandescent and the PAR 38 halogen lamps.

For example, for the 60W incandescent replacement lamp, the winning prize is \$10 million US. With target values for efficacy of more than 90 lm/W, power losses less than 10 Watts, lumen outputs more than 900, CRI more than 90, CCT between 2700-3000 K and a life-time of more than 25,000 hours, it is hard to reach the goal.

The initiators for the L Prize did a good job because stimulating the market will pay back manifold. The energy savings and environmental impact of this program is highly relevant: The 60W lamp replacement will save approximately 83% energy. In other words, a complete replacement of the 425 million 60W LED bulbs in the U.S. would save energy in the amount of 34.0 Terawatt-hours of electricity in one year and avoid 5.6 million metric tons of carbon emissions being produced. That's enough electricity to power the lights of about 17 million households. To keep the major business in the U.S. the entrants also have to fulfill one of the following requirements: 75% of the LEDs must be manufactured in the U.S.; the LEDs must be packed in the U.S. or the majority of the assembly must be done in the U.S.

Beside the technical requirements and manufacturing boundaries, entrants have to prove their capability for a mass-production capacity of 250,000 units per year and present reasonable prices to the end consumer. The first submission was made by Philips 16 months after the program started. Rudy Provoost, the CEO from Philips Lighting, is confident that their product fulfills all criteria, but the battle for the \$10 million is still on.

This L Prize program enforces improvements on every component in an LED lighting system. The Nov/Dec 2009 *LED professional Review (LpR)* may help you in this context. This *LpR* issue covers manufacturing cost aspects, driver issues, safety regulations, thermal resistance considerations and measuring techniques.

For more information about the L Prize, please visit the Department of Energy (DoE) website.

Hopefully other governments will see the L Prize as a good example to encourage people to go beyond the borders and create their own market stimulation programs.

We would be delighted to receive your feedback about *LpR*. Let us know what you like or tell us how we can improve our services. You are also welcome to contribute your own editorials.

Yours Sincerely,

A handwritten signature in blue ink, appearing to read 'Siegfried Luger', written over a horizontal line.

Siegfried Luger

Publisher

## Imprint

LED professional Review (LpR)

ISSN 1993-890X

### Publisher

Luger Research e.U.  
Institute for Innovation & Technology  
dep LED professional  
Faerbergasse 15, Haus Rot  
A 6850 Dornbirn, Austria / Europe  
phone +43 5572 394 489  
fax +43 5572 394 489 90  
editors@led-professional.com  
www.led-professional.com

### Publishing Editors

Siegfried Luger  
Arno Grabher-Meyer  
Alan R. Mills

### Account Manager

Theresa Koenig

### Promotion Manager

Silvia Girardelli

### Front-page picture

LED Measurement  
Artwork: Thomas Klobassa, ©LED professional 2009

### Copyrights – Luger Research e.U.

The editors make every reasonable effort to verify the information published, but Luger Research e.U. assumes no responsibility for the validity of any manufacturers, non profit organisations or individuals claims or statements. Luger Research e.U. does not assume and hereby disclaims any liability to any person for any loss or damage caused by errors or omissions in the material contained herein, regardless of whether such errors result from negligence, accident or any other cause whatsoever. You may not copy, reproduce, republish, download, post, broadcast, transmit, make available to the public, or otherwise use of *LED professional Review (LpR)* content without the prior written permission from Luger Research e.U. – Institute for Innovation & Technology, Austria. ■



### LED professional Review (LpR) – Annual Subscriptions

#### LpR Digital Magazine

- 6 issues
- pdf download
- high resolution pictures and graphs
- printable
- commercial use
- access to all previous issues
- Euro 78.80
- <http://www.led-professional.com/subscription>

#### LpR Printed Magazine

- 6 issues
- Euro 158.40

#### Next LpR Issue – Jan/Feb 2010

- LED Thermal Management

# Content

<b>Editorial</b>	p1
<b>Imprint</b>	p2
<b>Project News</b>	p5
<b>Product News</b>	p6
<b>Research News</b>	p13

## ■ Event Reports

### **OLEDs 2009**

by Alan R. Mills, LED professional p14

## ■ Applications

### **A Comparison of High Level European and U.S. Product Safety Requirements**

by John Showell, Product Approvals Ltd. p16

## ■ Technologies

### **Low Cost of Ownership Lithography for High Brightness LED Manufacturing**

by D. E. Anberg, Advanced Stepper Technology, A. M. Hawryluk, Ultratech Inc. p22

## ■ Optics

### **Practical LED Light Measurement**

by Wolfgang Dähn, Bob Angelo, Gigahertz-Optik p28

### **Photometric Measurements in Modern LED Based Optical and Illumination Systems**

by Juergen P. Weisshaar, Uta Vocke, opsira GmbH p32

### **Imaging Colorimetry: LED Device, Luminaire and Display**

by Hubert Kostal, Radiant Imaging, Inc., Christina Boehme, SphereOptics GmbH p36

## ■ Thermal Management

### **When Designing with Power LEDs, Consider Their Real Thermal Resistance**

by Dr. András Poppe, MicReD Division, Mentor Graphics Corp. p42

### **Silicones in LED's for Heat Dissipation and Improved Light Output**

by Chris Dawson, ACC Silicones p46

## ■ Drivers

### **Short Explanation of Critical Elements of a HB-LED Driver**

by Rakesh Reddy, Cypress Semiconductor Corp. p50

<b>LED professional – Patent Report</b>	p52
---	-----

## Advertising Index

<b>INSTRUMENT SYSTEMS</b>	p C2
<b>EDISON</b>	p 4
<b>OSRAM</b>	p 13
<b>LEDLIGHTFORYOU</b>	p 15
<b>LED CHINA</b>	p 21
<b>RADIANT IMAGING</b>	p 27
<b>LIGHTING JAPAN</b>	p 31
<b>LED TAIWAN</b>	p 41
<b>GIGAHERTZ OPTIK</b>	p 45
<b>MINLEON</b>	p 47
<b>TAIWAN INT. LIGHT SHOW</b>	p 49
<b>SEOUL SEMICONDUCTOR</b>	p C3
<b>CIE VIENNA</b>	p C4

## A Solid-State Lighting Premium Expert

Edison Opto Corporation is a Taipei, Taiwan based global leading high power LED manufacturer. The company offers a comprehensive product line ranging from 1 Watt to 100 Watt, single-chip to multi-chip, and high flux to high CRI. The diversified product offering will allow us to even the most challenging fixture designs.

### Flash 2016

Recognizing the increase application of LED in mobile devices, Edison Opto offers compact SMT packaged, Flash2016, for camera flash application.

- Type : Continuous/Pulse
- Flux : 50/105 lm
- $I_F$  : 350/1000 mA

New



New

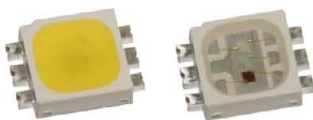

#### High Power PLCC LED Series

- Watt : 1W
- Type : 5050 W/5050 RGB 3 in 1
- Flux(typ.) : 85lm/R-7.3 G-13.3 B-4.0lm
- $I_F$  : 350mA/100 mA each die

Hot



#### Edixeon® A Series

- Watt : 1W
- Color : Cool White/Warm White
- Flux(typ.) : 110lm/75lm
- $I_F$  : 350mA

Hot!



#### EdiStar Module Series

- Watt : 50W/100W
- Type : Circular/Ellipse
- Flux(typ.) : 3,000lm@50W  
5,500lm@100W
- $I_F$  : 2,400mA@50W  
3,300mA@100W

## Project News

# Visionary Lighting Solution for Iconic Structure in Abu Dhabi

It's brand new. It can be seen from miles around. It's an architectural landmark that embodies key influences and inspirations from ancient Islamic art and traditions, melded with the artistry and geometries associated with speed, movement and spectacle. Its visual impact is all made possible by leading-edge LED technology.

The project represents collaboration between many disciplines, among them two primary entities: UK based Cooper Lighting, a lighting solutions design and engineering firm and Swansea-based Enfis Group Plc, a developer and manufacturer of SMART high-power solid state LED lighting systems.

The hotel's design was the brainchild of Asymptote Architecture, the New York-based architectural firm known for creating visionary building designs, master plans, and spatial experiments that challenge the traditional boundaries of architecture and integrate the potential of new technologies. The Yas Hotel truly embodies everything that is exciting about advanced contemporary design.

Of architectural and engineering significance is the main feature of the project's design, a 217-meter expanse of sweeping, curvilinear forms constructed of steel and over 5,300 pivoting diamond-shaped glass panels which are illuminated via a sophisticated LED lighting system from Enfis Group Plc, providing limitless shades and colors. This grid-shell component gives the building an atmospheric-like veil that contains two hotel towers and a link bridge constructed as a monocoque sculpted steel object passing above the Formula 1 track that makes its way through the building complex.

Extensive testing carried out by Cooper confirmed that the Enfis array/driver solutions actually exceeded the light output specification necessary to operate at these extreme ambient temperatures. Furthermore, Enfis SMART driver and LED array technology also offered Cooper:

- the ability to control each LED array, setting them to any desired color within a 4.2 billion color palette;
- two-way communication with each driver/array combination via Enfis software providing real-time monitoring of fixture temperature, CCT and energy consumption; and
- Remote Desk Management (RDM) DMX capabilities.

In the end, Cooper used over 5,850 Enfis LED arrays in its lighting design for the exterior environs of the Yas Hotel complex. The result is a testament to the "above and beyond" effort of the two companies working together. ■



A total of 208,800 LEDs were used on the project making it one of the largest LED projects in the world.

## Product News

# Orb Optronix: New Family of Advanced LED Measurement Systems

Orb Optronix announced its new family of advanced LED characterization systems. The ETΦ™ family of LED Characterization Systems, also known as ETΦ, is capable of measuring the complete electrical, thermal and optical characteristics of LEDs.

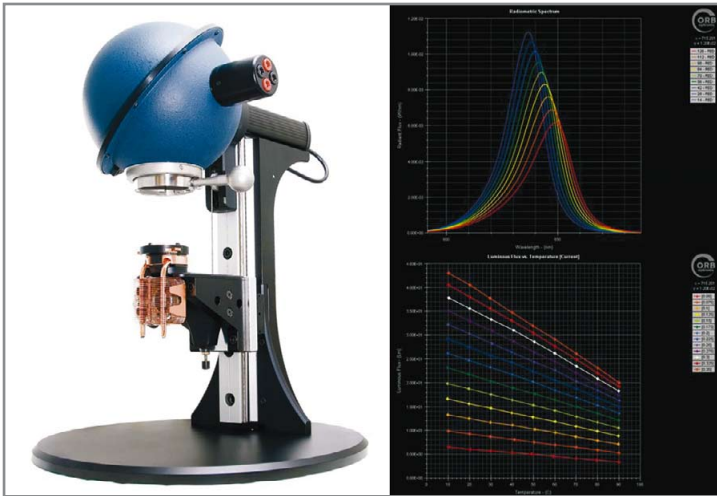

ETΦ LED Characterization System: Wavelength shift measurement and temperature dependent luminous flux.

This is great news for the LED industry in general where engineers around the world are engaged in designing LED-based products from advanced performance architectural lighting systems and medical diagnostic equipment to machine vision systems, display systems, street lights, avionics and military applications.

Companies from the very small to the very large are experiencing challenges with doing something they have never done before – designing new products with new capabilities, using LEDs. For many applications, LEDs are new and the engineering process is more involved than previous lighting technologies. The central issue for product development engineers implementing LEDs is designing systems that meet the performance targets for the product. These design targets are often the quantity of light output and color of the light over a range of ambient temperatures and electrical input power conditions.

As part of the design process, engineers must predict the performance of their LED system and determine if it will meet specifications at real operating temperatures and electrical drive conditions. To do this, engineers must have a means of collecting data. This is the crux of the engineering work for successful LED implementation. If product design is done poorly or inefficiently, the efficiency of the LED industry as a whole suffers.

ETΦ LED Characterization Systems assist product development engineers by solving the problem of efficiently measuring the quantity and color of light from LEDs over a range of temperatures and electrical input power variables. ETΦ LED characterization systems have both automated data acquisition and mature data analysis features. ETΦ systems allow engineers to automatically sequence measurements of light output and spectrum over a wide range of temperatures and currents, and comprehensive data analysis features allow users to quickly and easily view different groupings of data in over 300 graphs.

Information about LED manufacturer's statistical variability of color, wavelength, voltage, flux and other variables is not readily available, especially as a function of temperature and under a full range of drive conditions. Information of how LED performance varies from LED to LED is pivotal to designing robust LED illumination systems. Therefore, testing of multiple LED samples is critical to understanding and characterizing performance variability as a function of thermal conditions and electrical power inputs. ETΦ systems solve these problems by enabling the measurement of necessary parametric performance metrics on statistically relevant LED sample sizes easily and automatically.

Imagine attempting to control the color of light using LEDs when their light output, wavelength, chromaticity, CCT, forward voltage, efficacy and other performance metrics all change with respect to temperature, current, duty cycle and frequency. There is a tremendous amount of data required just to control color and light output. The Solid State Lighting industry along with others may now benefit from the pioneering work and development that Orb has done to support these engineering customers.

The ETΦ system, manufactured at Labsphere's facility in North Sutton, NH, is available with options for integrating sphere sizes from 6" to 76", a range of source meters and thermal platforms built for the measurement of discreet LED packages or high-power LED arrays and SSL subassemblies. ■

## Essemtec Improves Its Semiautomatic Printers

Essemtec's new stencil printers SP004 and SP150 print more accurately and are simpler to set up than their predecessors. The tabletop printer SP004 is a further development of the SP003, and the semiautomatic printer SP150 features a new option: the automatic electronic squeegee pressure regulation.

Flexibility and reliability are important, especially for the production of small- to midsize series. These are exactly the areas where the SP004 and SP150 are more advanced than other products.

SP150 is a semiautomatic printer with vision, automatic position control and an integrated stencil cleaning system. The new electronic squeegee pressure regulation option allows the required pressure to be programmed as a software parameter instead of a mechanical preset.



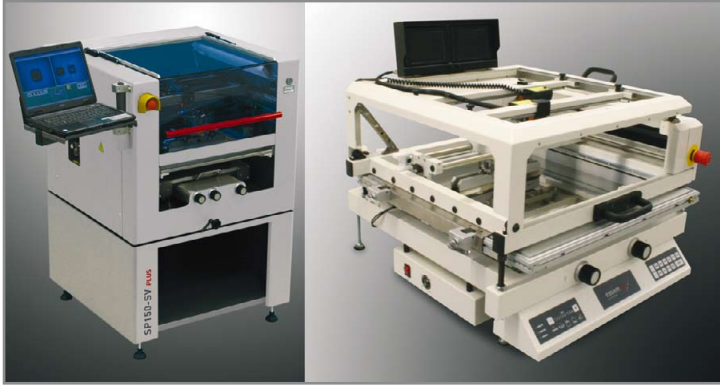

Essemtec's new stencil printers SP150 (left) and SP004 (right).

The tabletop printer SP004 is the next-generation model of the SP003. The system has been completely overhauled and now features simplified printer setup: The vision cameras are equipped with laser pointers and fast clamping systems. Within just a few minutes, the printer can be changed over from one product to another.

The SP004 allows printing with 20 µm accuracy and below, what makes it useful for fine-pitch and even ultra fine-pitch printing.

The system responsible for the separation of substrate and stencil after printing has been completely updated as well. Synchronous screws are now responsible for the controlled, exact parallel vertical motion. The speed of this motion can be set as well, ensuring that printed structures are precise even at ultra fine-pitch.

The SP004 printer is still equipped with the direct vision since the system requires no calibration: The vision cameras look straight through the stencil to the substrate.

For larger series, operators will appreciate the opening and closing servo system. It allows the cover to be lifted easily with two fingers, even if a 9 kg stencil and frame are mounted inside.

The SP004 will find a wide application range in electronics production. Due to its excellent precision, repeatability and flexibility it is well suited for production with many changeovers and high-quality requirements. It can print onto substrates up to 410x395 mm in size and 0.5 to 5 mm in thickness. Stencil frames up to 23 x 23" can be mounted. ■

## SemiLEDs Introduces the New I-core™ LED Chips

SemiLEDs has announced the introduction of the new I-core™ (IC) LED, an innovative new chip that will be featured in SemiLEDs' ultra high bright LED product portfolio. The release of the IC™ from SemiLEDs, a world leader in developing LED technology, demonstrates its commitment to creating customer focused, forward thinking solutions. The IC™ is the first product released in the I-core™ series of LEDs from SemiLEDs which are designed to provide further improvements in brightness, reliability and overall efficiency.

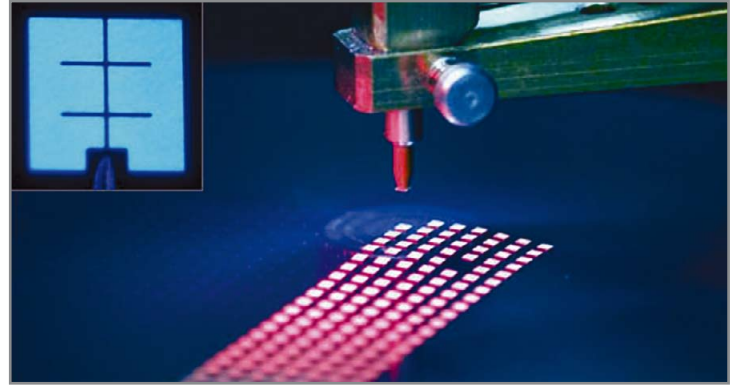

SemiLEDs new I-core™ (IC) LED.

The I-core™ LED features a sleek new design with new electrodes convenient for wire bonding. The advantages of the IC™ LED are realized in improved reliability which is delivered through the optimization of stress management for the chip at high current operation. The IC™ LED is not only more reliable, but significantly brighter as the creative robust design of the IC™ LED results in significantly improved light extraction. The advantages of the IC™ LED are further emphasized through SemiLEDs' patented and proprietary MvpLED™ chip technology which features a vertical structure with a copper alloy base for thermal dissipation effectiveness. The results of the IC™ LED have been impressive as an optimized white light package, 40 mil I-core™ chip can deliver 120 lm/W, a significant improvement over its previous version. ■

## New 3-Watt Titanbrite™ RGB LED from Lumex

Lumex has further expanded the company's extensive line of high-brightness LED technologies with the introduction of the 3-watt TitanBrite™ RGB, a square-shaped SMT LED technology that combines superior color performance with cost and real estate savings.

The square shape of the 10mm x 10mm TitanBrite RGB LED allows increased design efficiency with easier assembly and array formation opportunities. This feature is particularly useful for applications that require increased resolution for up-close viewing and for integration of dynamic, smaller images.

The innovative new technology is ideally suited for a wide variety of applications including electronic signage, safety/security lighting, general illumination, graphic backlighting, accent lighting and other applications that require bright, intense light and low power consumption.

"The TitanBrite RGB LED was developed in response to growing marketing demand for high- brightness LED RGB technology," explains Kay Fernandez, Manager of High Power Technology "Design engineers have become familiar with the superior color rendering of RGB LED technology, now they are looking for options that allow them to more efficiently take advantage of this superior performance."

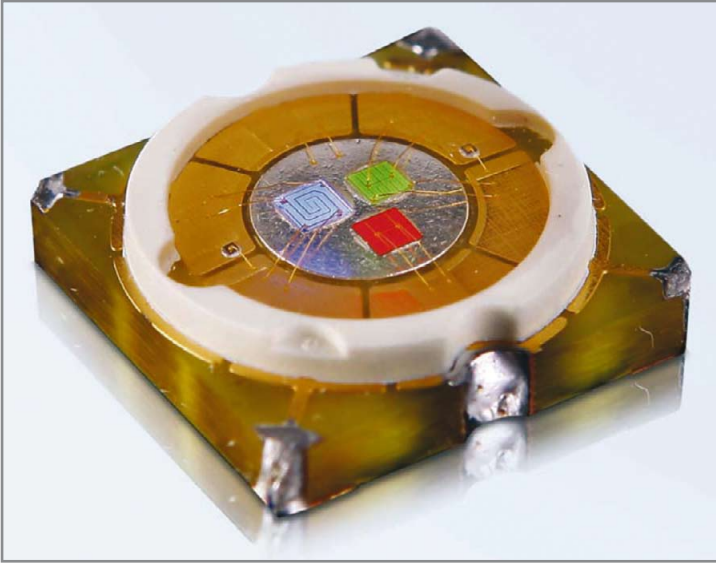

The square shape of the TitanBrite™ 3-Watt RGB LED allows increased design efficiency with easier assembly and array formation opportunities.

In addition to the design benefits made possible by the TitanBrite's square shape, RGB technologies provide several opportunities for enhanced efficiency. The use of a single TitanBrite RGB LED can result in up to a 30% cost savings as well as a 70% real estate savings compared to the use of individual red, green and blue packages.

RGB LEDs provide color rendering performance that is superior to traditional phosphor converted high-brightness white LED technologies. This enhanced color consistency is especially beneficial for lighting applications that require warm white light that closely matches incandescent lighting. RGB light allows for adjustable color tuning that not only can create shades of white, but almost every other color in the visible spectrum as well.

The RoHS compliant TitanBrite RGBs contain three individual 1-Watt dies in red (636nm), green (525nm) and blue (470nm). ■

## EPISTAR Achieves 110lm/W Warm White LED for 1W and 3W Operation

Epistar has developed a technology to reach high CRI and high efficacy for warm white LED to replace the low efficacy incandescent light bulbs. Efficacy and color rendering index (CRI) are the two major performance merits in the lighting industry using white light LED, nevertheless these two merits usually work against each other. Epistar's approach enables improvement of these two merits simultaneously.

Epistar has developed a technology to reach high CRI and high efficacy for warm white LED to replace the low efficacy incandescent light bulbs. Efficacy and color rendering index (CRI) are the two major performance

merits in the lighting industry using white light LED, nevertheless these two merits usually work against each other. Epistar's approach enables improvement of these two merits simultaneously.

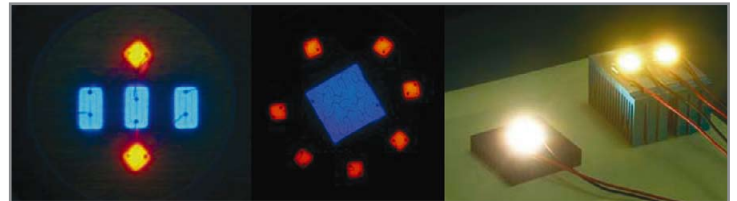

One and three watt packages without phosphors and the light-up packages with the yellow-green phosphor coating (from left to right).

The 1W package has the CRI of 90 and efficacy up to 110lm/W for lower voltage (15V) operation while the 3W package has the CRI of 90 and efficacy up to 105lm/W for higher voltage (50V) operation. Both these packages have the CCT of around 3000K. The 1W lamp combined several Epistar's blue and red LED chips in the same package, coated with yellow/green phosphor. The power consumption and total lumens can be adjusted by modifying the combinations of the LED chips. The 3W lamp used one high-voltage monolithically integrated DC multiple-chip array combined with several Epistar's red LED chips. Yellow-green phosphors were used in both 1 and 3 watt packages. A bridge structure can be used with the 3W lamp to achieve the AC drive. These packages can be used in the E12/E14 candle light, E26/E27/GU10 light bulbs, PAR light and other applications for high efficacy warm white. ■

## Cree XLamp® MX-6 LED: First Lighting-Class PLCC LED

Cree, Inc., a market leader in LED lighting, extends its lighting-class LED leadership into PLCC LEDs with the commercial availability of the new XLamp® MX-6 LED. The MX-6 LED offers the performance and reliability that customers expect from Cree XLamp LEDs with enhanced light uniformity and low power consumption.



Cree's XLamp MX-6 lighting-class PLCC LEDs.

"We are impressed with the Cree XLamp MX-6 LED," said Sunny Tsai, CEO of TESS, an innovative LED light bulb manufacturer. "The LED's performance is striking, and Cree's small bins make it easy for us to deliver a consistent product for our customers."

"With the addition of the XLamp MX-6 LED, we now have the most diverse family of lighting-class LEDs in the industry," said Paul Thieken, Cree marketing director, LED components. "The XLamp MX-6 LED can provide better design options for indoor applications, including under-cabinet, retail displays, LED light bulbs and fluorescent replacements."

The LED provides up to 130 lumens for cool white and 107 lumens for warm white at 350 mA. The XLamp MX-6 LED can also reduce luminaire and lamp manufacturing costs through an increased shelf life with reduced moisture sensitivity, and the smallest warm white bins in the industry, enhancing LED-to-LED color consistency. ■

## NXP SSL 2102: Integrated Dimmable Mains LED Driver IC

NXP Semiconductors announced three major developments in its portfolio of mains connected LED driver solutions: the success of its SSL2101 LED driver IC in matching LED lifetimes in an accelerated lifetime test; the introduction of the SSL 2102 integrated dimmable mains LED driver IC for SSL retrofit lamps and modules; and the launch of its online design tool for SSL applications, which makes it easy for engineers to test the behavior of LED lighting applications based on four NXP products.

"LED lighting has the potential to be ten times more efficient than incandescents, with manufacturers reporting lifetime figures exceeding 50,000 hours. The reliability of the electronic components – particularly the LED driver – is critical to the overall reliability of most LED systems," said Jacques le Berre, director of marketing and business development for lighting solutions, NXP Semiconductors. "Through our ongoing lifetime test, which has now surpassed 7,000 hours, we've set a new benchmark and proven that NXP's mains LED controller and driver ICs are up to the challenge of supporting extreme long-life lamps. Further, the addition of the SSL2102 and the launch of our new online design tool are making it even easier for innovative lighting companies to accelerate product development and speed the adoption of LEDs in the general lighting market."

NXP has been conducting the industry's longest-running test of LED driver. The ongoing lifetime test is focused on the SSL2101, the industry's first integrated dimmable mains LED driver IC announced earlier this year. NXP tested a random lot of SSL2101 IC drivers from standard production in high-stress conditions, all of which remain fully functional after running for over 7,000 hours with an IC junction temperature of 150°C. Multiple tests and set-ups were used to detect all possible failure modes in several use cases: continuous-on, on/off switching cycle and various combinations.

**The extrapolated lifetime of the SSL2101 in real lighting applications, based on a lifetime acceleration model, is estimated as follows:**

- Over 60,000 hours lifetime at 105°C
- Over 35,000 hours lifetime at 115°C
- Over 20,000 hours at 125°C
- Over 7,000 hours at 150°C

The test is part of an NXP project dedicated to assessing the actual lifetime of its latest LED drivers, running reliability tests until product end of life.

The SSL2102 is the latest addition to NXP's lighting portfolio, offering deep dimming down to one percent of full light intensity, as well as compatibility with a wide range of dimmers. The small, highly integrated and highly efficient driver is the next step in SSL retrofit LED lighting, and is ideal for small form-factor applications with closed casings.

The SSL2102 is suitable for high-efficiency and high-power factor SSL applications, including SSL retrofit lamps from 8W to 15W; LED modules such as LED spots and down-lights from 15W and 25W; and LED strings for retail display up to a maximum of 25W.

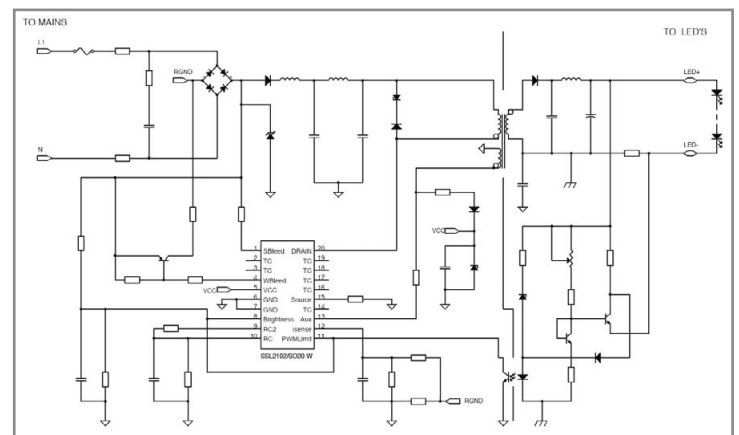

SSL2102 application example: 12W to 25W triac dimmable LED driver with a power factor of above 0.9 and accurate output current

**Key features of the SSL2102 include:**

- Natural dimming via a built-in logarithmic curve
- Support for the majority of available dimmers (e.g. TRIAC, transistor)
- Limited external components required due to high integration level
- Switched SMPS controller with buck and flyback configurations
- Thermally enhanced SO20 wide body package
- Valley switching detection for optimized efficiency
- Built-in demagnetization detection
- Built-in Over Temperature Protection (OTP)
- Supports start-up from rectified mains voltage

A fully integrated LED driver that includes both the controller and the switches, the SSL2102 offers the same functions as the SSL2101 but with higher power, enabling design engineers to use one design on several different end products for a wider range of power ratings. ■

## MeanWell: AC/DC Open Frame Power Supply Series

After introducing aluminum casing (CLG family) and fully enclosed plastic casing (PLN, PLC, ELN, LP family) LED power supplies, MEAN WELL launched another LED product category, AC/DC open frame type for the "low cost" and "built-in" installation of LED lighting related applications.

Main Features:

- 4"x2" miniature PCB design
- 90~264V universal AC input range
- Built-in active PFC function, comply with EN61000-3-2 Class C for 75% load or higher
- PF>0.9 for 75% load or higher
- High efficiency up to 89%
- Cooling by free air convection
- Protection: Short circuit / Overload / Over voltage
- Suitable for built-in LED lighting fixtures
- Low cost, high reliability
- Comply with EN61347-2-13, EN55015, EN61547 per lighting regulations
- 2 years warranty

The new PLP-45(45W) along with existing PLP-30(30W) and PLP-60(60W) series, MEAN WELL can currently offer LED system designers three different wattage options – 30W, 45W and 60W, which could fully satisfy the low power wattage requested by LED lighting designers. Featuring 90~264VAC full range input and built-in active PFC function, PLP-45 series can comply with EN61000-3-2 Class C (harmonic current) and PF>0.9 when output loading is higher than 75% to fulfill the general requirement of lighting fixtures. ■

## LBT Releases Triac Dimming Solution for LED Fixtures

Light-Based Technologies is pleased to announce the release of their first LB4™ LED Controller application, Triac Dimming for LED Fixtures. This application capitalizes on the capabilities of LBT's proprietary linear mixing system and the biggest need in the general Solid State Lighting (SSL) market, standard wall dimming control.

Triac dimming is crucial to the adoption of SSL for one simple reason: the retrofit market. There are 110 million households in North America and triac dimmers have been the most common light controller installed for over 25 years. In addition, the early compact fluorescent light bulb could not be controlled with a standard wall dimmer slowing the adoption of energy efficient lamps. To top it all off, in order to meet strict Energy Star requirements, LED fixtures must have dimming capabilities.

The LBT solution stands out as the highest quality and most flexible solution for LED fixture manufacturers available on the market. The solution is also simple and cost-effective to implement. Design LED fixtures with the LB4™ LED Controller inside, screw the fixtures into standard housings and control brightness to your liking using an existing dimmer. You can have control characterized to mimic traditional incandescent bulbs or customize to a linear or logarithmic function if desired.

Though the retrofit market makes triac dimming important, currently there is a lack of LED control standards going forward. What will home lighting control look like in 10 or 20 years? Triac dimmers require less wiring than other protocols and have lower hardware costs than wireless solutions. In addition, consumers know how to use dimmers, installers are familiar with their requirements, and companies have invested large amounts of capital around their manufacture. Triacs will be around for years to come. "The team at LBT is ecstatic to present their solution of triac dimming control for LED fixtures," says Jeanette Jackson, Chief Executive Officer of LBT. "The smooth, seamless control combined with LBT's unique control technology means that our triac dimming solution is very significant to the industry, our company and consumers." ■

## Powercast: Economical, Energy-Efficient and Adaptable

The demands placed on high-quality outdoor lighting have been constantly rising. The result is that economical considerations and the energy-efficiency of the lighting tools used are now just as important as the precise illumination of architectural details and optimum visual comfort. ERCO meets these specific requirements with its new luminaire range: Powercast. These all-purpose projectors and floodlights use current technologies such as LEDs and Spherulite reflectors to provide high visual comfort with exceptional economic efficiency.

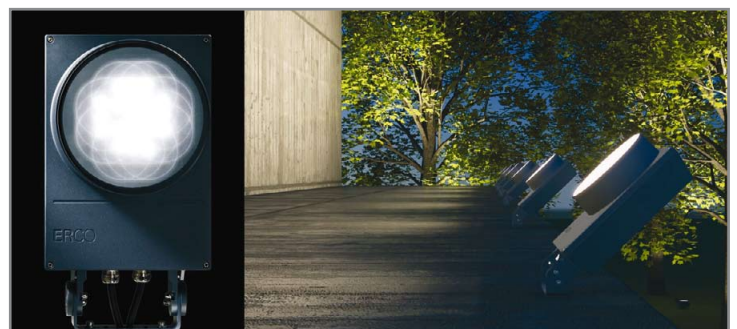

Powercast projectors with LEDs for extremely energy-efficient and maintenance-free operation.

Whether for the accent lighting of signs or vegetation or to floodlight entire facades or arcades, the various projectors and floodlights of the Powercast range cover a wide spectrum of applications. Their system design uses a uniformly styled housing, which has many practical

installation features and is extremely weatherproof. The multiply powder-coated cast-aluminium housing is rated to IP65 protection mode and is available in two sizes. It contains all the lighting components and control gear. It can be mounted on the wall, floor or ceiling with the robust mounting bracket or in combination with purpose made brackets by others. A ground socket is also available as an accessory for mounting on the ground. A lockable hinge inscribed with a scale allows the angle of inclination to be set accurately and makes precise alignment easier in outdoor areas. The housing features two cable entries to allow for through-wiring.

Powercast projectors can produce all the required light intensity distributions – from narrowly focused beams to wide flood patterns. The luminaires fitted with LEDs are particularly efficient and, thanks to their long life, virtually maintenance-free. The projectors are available, with LEDs up to 42 watts, in the warm white and daylight white colours. To control the light, ERCO has developed innovative lens systems consisting of a collimating lens to form parallel rays and Spherolite lenses to create various beam angles. With the LED projectors, a choice of light intensity distributions is offered: "spot" for precise accent lighting, "flood" for the efficient highlighting of larger objects and "wide flood" for wide flooding illumination of surfaces.

"Oval flood" and "washlight" Spherolit reflectors, which are also replaceable without tools, are available. With the oval flood version, the reflector can be freely rotated and clicked in position in 90° steps to allow the axes of the oval beam to be orientated to suit the requirement. The asymmetric light distribution of the washlight version is ideal for the illumination of vertical surfaces such as facades, walls or hedges. ■

## Cree Demonstrates Record-Breaking LED Light Bulb

At the annual Cree (Nasdaq: CREE) shareholder meeting, Cree Chairman and CEO Chuck Swoboda demonstrated an A-lamp LED light bulb with the highest lumen output and efficacy reported in the industry. The bulb produces 969 lumens at an impressive 102 lumens per watt, which is the light output equivalent to a 65-watt incandescent bulb, yet it uses only 9.5 watts.

The demonstration A-19-style bulb features the latest Cree production XLamp® XP-G LEDs and TrueWhite Technology, a patented method of delivering warm-white light with superior color rendering and efficiency. It delivers a 2800 K warm-white light with a 91 CRI. All data was verified by third-party testing under steady-state operating conditions.

"We are pushing the industry by demonstrating what's possible," said Swoboda. "With every improvement in LED components, new applications become achievable. We are excited to show the world not only what can be done, but what they should expect in an LED light bulb." ■

## LEDnovation Introduces Neutral White LED Light Bulbs

LEDnovation, Inc. introduced two new LED bulbs for the North American Market. The company claims that the LED bulbs are the industry's first and highest brightness 60W and 75W incandescent A19 equivalent replacement bulbs.



SPECIFICATION DATA	
Light Output (Lumens)	700 lm
Watts	9.8W
Lumens per Watt (Efficacy)	71 lm/W
Color Accuracy (CRI)	85
Light Color (CCT)	3500K - Neutral White
Voltage	90-135 VAC, 60Hz
Power Factor	> 0.9
Rated Life	> 35,000 hours
Form Factor / Base Type	A19 / E26 base (US)
Incandescent Equivalency	75 Watts
Warranty	3 year standard
Environment	Indoor Use Only
Intellectual Property	Multiple Patents Pending

75W equivalent LED bulb and key data.

The 60W equivalent delivers 600 Lumens with a typical efficiency of 79 Lumens/Watt and consumes 7.6 W. The bulb consumes 87% less power than a standard 60W incandescent bulb and 42% less than a standard 13W Compact Fluorescent. The 75W equivalent delivers 700 Lumens with a typical efficiency of 71 Lumens/Watt and consumes 9.8W. This lamp consumes 86% less power than a standard 75W incandescent bulb. Both LED bulbs have a CCT =3500K, typical CRI of 85 and power factor >0.9. The Lamps feature Recycled Reflectance™ optics technology, which reduces overall glare and delivers an extremely uniform and smooth light output in the A19 standard form factor.

The products are targeted at downlight and other indoor general lighting applications in the commercial and industrial markets. These next generation bulbs are part of the EnhanceLite™ series of LED bulbs. LEDnovation's 60W equivalent LED A19-60-1N-I and 75W equivalent LED A19-75-1N-I products are scheduled to be commercially available in November 2009 for the North American market. ■

## Research News

### OSRAM: Transparent Super Low-Profile OLED

The OLED prototypes that OSRAM Opto Semiconductors has developed as part of a research project are large transparent light sources only a few hundred micrometers thick. Thanks to new technology these organic light emitting diodes do not need separate encapsulation and can be made incredibly thin in any layout. The transparent test samples have a luminous area of 210 cm<sup>2</sup> and are already showing the enormous potential of OLED light sources. They offer a tantalizing glimpse of the extraordinary lighting applications that may one day become reality.



*When it is switched off the OLED light source is barely noticeable. When it is switched on it produces an even light with high luminance over its entire surface.*

Even the 17 x 17 cm OLED panels provide a clear indication of the direction that the OLED lighting market is taking. The test samples were developed as part of the TOPAS research project funded by the German Ministry for Education and Research (BMBF).

Even though the modules will have to be made larger they already have many of the properties that distinguish OLEDs from other light sources. These low-profile OLED modules will be even easier to use in all kinds of applications. They can be made in any shape, take up very little space and can be integrated so discreetly that they are only noticed when they are switched on.

The OLED panels can be made transparent without any detracting structures. This is thanks to new developments in electrode design, a special component architecture and a new approach to thin-film technology. Without any additional conductor path structures on the light-emitting surface, the current is distributed evenly over the active

surface, which in turn leads to uniform luminance. The new technology also simplifies the manufacturing process. Irrespective of the material of the active layers, the technology can be used for colored, warm white and cold white OLEDs. The next stage is to integrate the processes into a stable manufacturing operation. ■

### OSRAM Warm White LED with High Efficiency and True Colors

OSRAM Opto Semiconductors has developed an LED that offers high efficiency, excellent color rendering and a pleasant warm white light, namely a color temperature of 3000 K, a color rendering index of 82 and an efficiency of 104 lm/W.

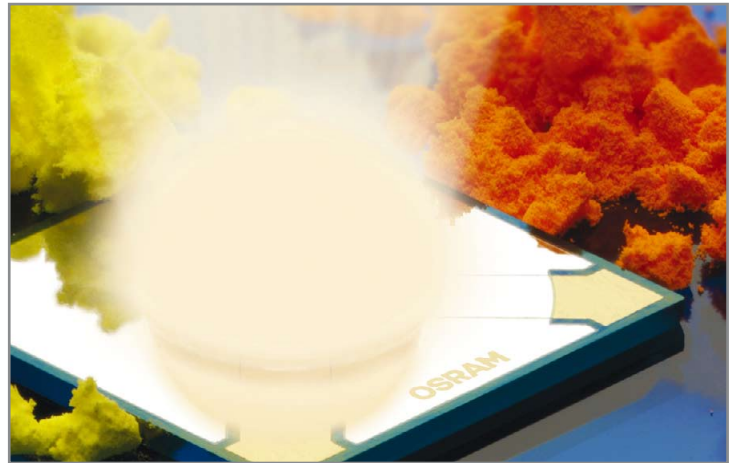

*A new converter mix that OSRAM is currently testing in its development laboratory provides a pleasant warm white light.*

The pleasant light from this warm white LED is the result of an advanced conversion process. Not only is the quality of light excellent, but the efficiency with which it is produced is also ground-breaking. The combination of these properties is essential for the widespread use of LEDs for general illumination as the warm white light color is targeted specifically at the residential sector. "The successful combination of high quality of light and excellent energy efficiency will bring the commercial breakthrough for LED technology even closer. Efficient, pleasant light is no longer just a vision."

At 3000 K, the light color of the LED is similar to that of a halogen lamp. Its color location is precisely on the Planckian curve, and the light is exactly white showing no shift to the green spectral region. With an operating current of 350 mA and a chip surface of 1 mm<sup>2</sup>, the prototype of the new single-chip LED achieves a brightness of 124 lm, which corresponds to an efficiency of 104 lm/W. These record results are based on in-depth OSRAM expertise in providing a new chip architecture in conjunction with improvements in silicon crystal growth technology, improvements in the converter mix, and a high-efficiency package. OSRAM will be gradually integrating the new technologies into production. ■

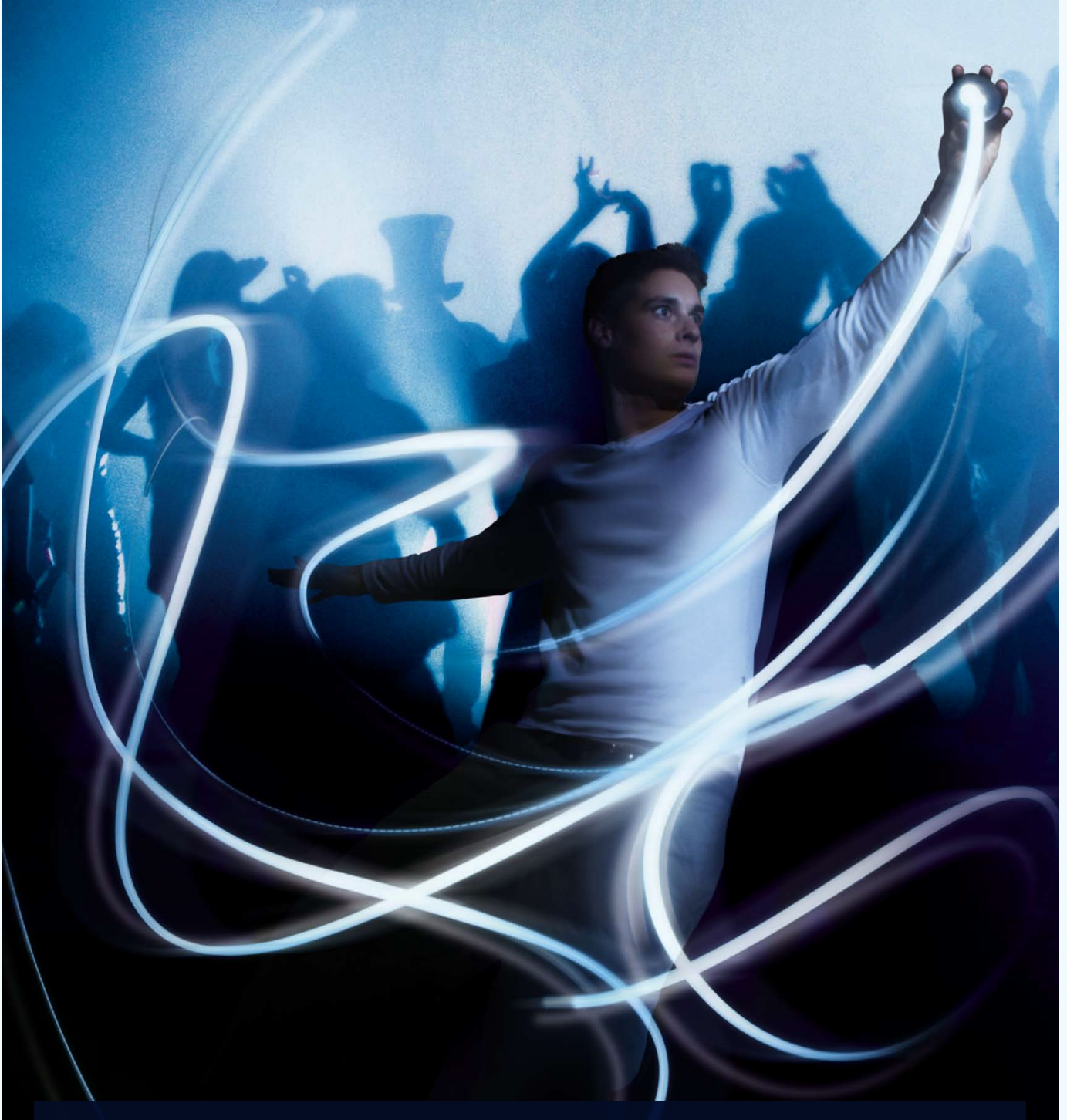

## LEDs for General Lighting Solutions

OSRAM Opto Semiconductors empowers lighting solutions for today and tomorrow

Opto Semiconductors

**OSRAM**

## Event Reports

### OLEDs 2009

> Alan R. Mills, LED professional

The 2009 Intertech-Pira OLED conference was held in San Francisco's Japan Town. With over 100 enthusiastic industry supporters in attendance, the meeting provided an update on the technology and markets and was well worth the time spent, although it deserved a larger number of exhibitors. The keynote address on the future opportunities for Active Matrix Organic Light Emitting Displays (AMOLEDs) was given by H.K. Chung from Samsung Mobile Display. He has been active in the field of AMOLEDs for about ten years and has received several related awards including one from the Society of Information Display in 2006. He believes that future products must be Eco-friendly and appeal to the consumer and will include small TVs and wearable and flexible display designs. Historically the first passive matrix OLEDs (PMOLEDs) were developed in 2002 and mass production peaked in 2006, but the active matrix displays (AMOLEDs) are now the preferred technology with KDDI using 2-3" AMOLED displays on some Japanese cell phones and small displays (<4") are now in use in Korea and the USA.



Figure 1: For mobile phone displays, OLEDs have several advantages over other solutions, but they are expensive and have - with about 10,000 hours - a shorter life time than their anorganic relatives.

Samsung announced a 2.8" AMOLED touch display in January 2009, which are currently being produced at the rate of 2.4 million units per month. Their display road map calls for an increase to 10 million units per month in 2010 and for small TV sets to be introduced in the second half of 2011. Several challenges remain for OLED technology and include, image sticking (or retention), cost reduction, expansion into larger display sizes, longer lived blue emitters (red emitters now exceed 25,000 hours), power consumption with a white background, a change from CMOS- to PMOS-TFTs (which should reduce processing costs by about 40%) and large area printing capabilities. OLEDs are recognised as the best candidates for flexible displays where R&D on plastic film has

currently achieved 20 micron thick 6.5" RGB displays with 480x272 pixel resolution. Future applications for flexible and transparent displays include such items as electronic passports and driver's licences and LG has just announced a transparent cell-phone use, but only for the keypads. Developments in AMOLED capacitive touch screen technology are moving from 2D to 3D, with 3D AMOLED displays forecast for 2011. An audience member reported some complaints about OLEDs being difficult to read in sunlight, however Samsung noted that they are working on automatic brightness increases and reflectance OLEDs (similar to those used for LCDs).



Figure 2: OLEDs are recognised as the best candidates for flexible displays.

OLEDs are a growing market, mostly for displays of less than 4 inches. Even with more than 20 AMOLED phone models currently being offered there is only a low level of market penetration. However, Jennifer Colegrove, Director of Display Technology at Display Search, reported that OLED revenues will break records for the third and fourth quarters of 2009 and LG will offer a 15" TV in December 2009, but only for Korean distribution. The OLED display industry is quite optimistic with about 20 million OLED phones being shipped in 2009 (out of a total of about 1.5 billion). AMOLEDs will be the key display technology through 2015 and Jennifer reported that 20 new fabs are planned for the next three years, with display yields that approach those of TFTs. There is also a lot of OLED production hype coming from China.

Recent technology advances in AMOLEDs include phosphorescent display development at Arizona State University and the development of conducting transparent mixed oxides (from indium, tin and/or zinc) to replace ITO. Small molecule organic materials are widely used today, but polymeric OLED technology may reverse this trend by 2011, depending on the specific technology costs and their field performance and reliabilities. For large supported OLED light emitters, large areas of flat glass will be required and Corning Holding Japan G.K. is already well advanced in this field. Kevin Glovins described their Jade® large substrate glass, which is heat treated to provide less thermal shrinkage, creep and sag, yet has a surface roughness of only 0.1-0.2nm.



The OLED display market is expected to grow from \$600 million in 2008 to \$6.2 billion in 2016, with OLED displays for notebook PCs being forecast for 2013 introduction and mini-notebooks for 2014 and by 2016 TVs should be the 2<sup>nd</sup> largest OLED application. Display search forecasts that for larger market penetration OLED display costs need to be reduced to less than \$1000 per square metre. Large scale use of OLEDs for lighting is a forward looking proposition with some products forecast for 2013, but with Q-4 2009 commercial LEDs already at 350 lumen outputs and 139 lm/W efficiencies other forecasts see little OLED penetration before 2020. Requirements for a 5x improvement in OLED brightness and presumed costs of less than \$100 per square metre for wall and ceiling light panels may be required. Thus, with AMOLEDs currently emitting in the 20 to 40 lumens per watt range and also being more expensive, LEDs are expected to be well entrenched in the general lighting market by this time and may provide significant competition except where OLEDs have distinct application advantages. According to the OLED association, a recently formed group of nine companies actively promoting the products and technology, the target lighting market, coveted by LED and OLED suppliers alike, is currently about \$90 billion with today's market shares being; fluorescent tubes 39%, incandescent bulbs 28%, halogen ~18%, high intensity discharge 13%, CFL 1% and the LED 0.5%. Contact for the OLED association can be obtained via [barry@oled-a.org](mailto:barry@oled-a.org).



Figure 3: One of the first OLED TVs on the market.

Flexible polymer displays (e.g. on PET), especially presenting low information level, is a market segment where OLEDs will dominate and Matthew Wilkinson, President and CEO of Add-Vision Inc., presented a working example of a 6" colour display, where only 5 layers were used (a printed air-stable cathode, a doped light emitting polymer, a barrier film, an ITO layer, and the flexible plastic substrate). Commendable operating properties have already been achieved with a shelf life of greater than 2 years, a bend radius of 5mm, display thicknesses of 150-300nm, and operating voltages of 9-36V for white and 8-15V for yellow. Additionally, the time to 50% light output has increased from an initial 300 hour period to over 11,000 hours of operation during a one-year product development period. The military are very interested in flexible displays and are now using an Add-Vision product that is shipping at

the rate of 30,000 square feet per month. With continuing development, Add-Vision hopes to lower these display prices from about \$1 to about the \$0.2 per square inch range. For some applications OLEDs will become the preferred technology, but for others they will face stiff competitive conditions from technologies with quite a head start.



Figure 4: Philips OLED Chandelier and OLED Tabletop are examples for OLED lighting applications.

The support for OLEDs as a lighting source is strong with over 100 companies and universities working in this field to develop surface, panel and other OLED luminaires on glass, plastic or metal surfaces. They will operate over wide temperature ranges, with low forward voltages and CRIs over 80, but they will need light output powers in the 30 to 140 lm/W range. Initial commercial products within this power range will be offered in the 2010-2015 time period. ■



[www.ledlightforyou.com](http://www.ledlightforyou.com)

**Our partners are looking forward to your ideas.**

More than 50 partners world-wide await you in the LED Light for you network. These OSRAM-certified providers will be pleased to assist you in finding the right optical, thermal and electronic solutions for your lighting application.

The network for LED lighting technology.



## Applications

# A Comparison of High Level European and U.S. Product Safety Requirements

> John Showell, MSc CEng MIET, Product Approvals Ltd.

LED lighting product manufacturers have many challenges to face in getting new product designs launched into the marketplace. Apart from the many technical challenges and problems that must be solved to arrive at a commercial quality product fit for release to customers, in an industry which is consistently making very rapid advances in technology, it can be easy to overlook perhaps what may be considered by some as the less glamorous area of meeting the mandatory regulatory requirements of the countries targeted for product launch. Larger established companies are likely to be well versed in regulatory requirements and may even employ specialist conformance engineering staff but the nature of the LED lighting industry and the opportunities arising is leading to many new start-up companies that may not be sufficiently aware of requirements and safety engineering practices. A challenge still exists for the larger companies for example with training new design engineers, entering new markets and addressing the expanding product liability risks and possible product recall probability which increase with product range and production volume. Some of the largest companies will employ a legal professional and develop strategies and contingency plans in the case of a voluntary or mandatory product recall.

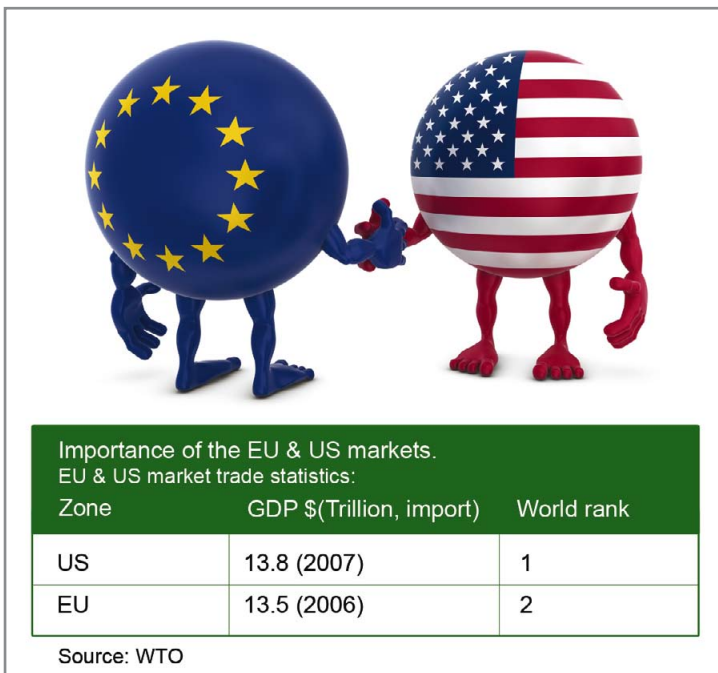

Figure1: EU/US handshake, istockphoto ref # with brief WTO data on the GDP of the EU & US.

It is the intention of this article to explain key regulatory requirements in the compliance engineering field of product safety, for the European and U.S. marketplace. Armed with a knowledge of these key requirements, manufacturers can decide how best to design their product safety compliance strategies and processes to ensure a smooth transition of the product from concept stage through to delivery to customers and volume production.

## High Level Safety Regulations

Design for product safety must encompass a firm understanding of higher level safety regulations for the target markets and once this is achieved, manufacturers can confidently manage and execute a safety design process which will ensure timely and cost-effective attainment of mandatory and desired safety approvals.

### European high level safety regulations

Most manufacturers will have some familiarity with the high level safety requirements for the European Union – namely CE marking to the Low Voltage Directive – LVD (2006/95/EC). The relevant content of the LVD should be reviewed for new product designs especially with regard to new or unusual applications. It is useful to keep in mind that application of the harmonised standards is the preferred way to achieve the goal of complying with the high level requirements of the LVD (see Table 1).

Techniques traditionally originating from safety-critical industries such as energy (e.g. oil and gas production) and transport (e.g. railway signalling) are increasingly being used in the consumer and related product industry sectors. Such techniques include fault tree analysis (FTA), event tree analysis (ETA) and failure mode effects and criticality analysis (FMECA). Also safety-critical functions are increasingly finding their way into products which did not originally provide this functionality. In the world of industrial automation for example, some electronic variable speed drives for motor control now feature a 'safe stop' ability complying with a recognized functional safety standard such as EN 61508-1 – Functional safety of electrical/electronic/programmable electronic safety-related systems - Part 1: General requirements. We are likely to see similar trends with LED lighting products increasingly being used in safety critical applications such as airport runway lighting systems. LED product designers for such applications will need to become aware of how to calculate Safety Integrity Levels (SILs) and add this as a new skill to the more traditional safety related knowledge such as calculating electrical spacings to withstand mains borne transient voltage surges (in the case of TVS, needing to be sufficient for the actual application demands but also to meet mandatory requirements for safety purposes). Certainly the application of the safety analysis techniques discussed above could be helpful to LED lighting manufacturers in performing initial and follow-up product hazard analyses to supplement the more rigid application of individual product safety standards and even identify hazards that are simply not envisaged or addressed by meeting the product safety standard requirements alone. A case comes to mind whereby the product in question fully met the relevant UL standard yet a subsequent safety hazard analysis

LVD article number	Key requirement	Comments
1	'Electrical equipment' operating at 50 – 1000Vac, 75 – 1500Vdc is in the LVD scope.	Although an LED light module rated for a supply voltage under 75Vdc would be exempt using this voltage criteria, the LVD may still offer relevant advice regarding other hazards to be considered. Clearly, complete end-products with e.g. 240Vac supply voltage rating will come within the scope. For instances where the LVD does not apply, consider also application of the General Product Safety Directive 2001/95/EC, though the CE mark cannot be applied with reference to the GPSD.
2	The equipment must not endanger humans, animals or property when used and installed as intended.	A high level hazard analysis to the LVD articles may reveal issues to be addressed that may be overlooked when using detailed product specific standards documents. This hazard analysis may be included in a Technical File to assist demonstrating conformity with the LVD.
5	Equipment complying with the safety requirements of harmonised standards satisfies article 2.	Identifying the correct harmonised standard or standards is crucial to creating a robust safety case. High level hazard analysis can help to determine standards or parts of standards that may be applicable.
6, 7	If a required harmonised standard is not yet available, alternative safety standards such as IEC may be applied, or use other suitable standards published by the member state to achieve equivalent safety levels.	Gives a route for developing a safety case e.g. for very new technology, aspects of which may not be envisioned or addressed by an existing harmonised standard.
8	The CE mark should be affixed to the product before it is placed on the market. It indicates all relevant directives have been complied with.	It would be acceptable to demonstrate a pre-production non CE marked unit for example at an exhibition, with adequate safety measures put in place.
10	The CE mark may be placed on packaging or product documentation if not able to be placed on the product.	This article also has a procedure to deal with discovery of CE marks placed on equipment when there should be no CE mark applied.
Annex II	Lists types of specialised equipment not inside the scope of the LVD.	Examples include products for use in explosive atmospheres, products for use on ships, aircraft and railways.
Annex III	Contains CE mark graphics requirements and what should be in the Declaration of Conformity (DoC)	DoC should include manufacturer or representative name and address, reference to harmonised and any other standards or specifications for which conformity is declared, signature of authorising person, last two digits of year of CE marking.
Annex IV	The manufacturer must create technical documentation to show the equipment conforms to the LVD, and put in place an adequate process to ensure ongoing conformity.	The Technical File must be available to authorities up to 10 years after cessation of production. It should contain details including description of equipment, product electrical and mechanical design data, operation instructions, list of standards applied, and how safety has been addressed if standards not used in any instance, results of calculations, examinations and tests assuring safety. An ISO 9000 manufacturing quality system can help to demonstrate ongoing LVD conformity.

Table 1: Summary of the key high level requirements paraphrased from the LVD. Refer to the full LVD text for complete guidance (Remark: A harmonised standard is one that has been adopted and agreed by EU member states and its title recorded in the Official Journal of the European Union).

revealed hazards in the product that were not covered by the UL standard and a design change was required. So simply complying with the relevant industry-recognized standard for a particular product category may not be enough to assure a safe product or defend successfully against a potential lawsuit.

Be sure to enquire whether your product liability insurer will give you discount from the insurance premium in recognition of having performed the analysis and documented any corrective measures. Prudent manufacturers will consider whether they should print specific legal disclaimers in their product manuals for example stating that the LED product is not suitable for use in a safety critical application - if it is not designed for that purpose (or unless designing safeguards into the system against failure). It is advisable to take the advice of a specialist Attorney when developing additional safety related warnings to ensure they are legally effective.

### U.S. high level safety regulations

We have seen that high level safety regulations for Europe are encompassed in the Low Voltage Directive. So what are the equivalent high level safety regulations in the U.S.A. and what are the key differences?

### Main high level regulations:

- The Occupational Safety and Health Association (OSHA) 29 CFR (Code of Federal Regulations) 1910 Subpart S (Electrical) regulations. OSHA is a section of the U.S. Government's Department of Labor.
- The National Fire Prevention Association (NFPA) standard number 70 – the "National Electrical Code (NEC)".
- The NFPA standard number 70 E – the "Standard for Electrical Safety in the Workplace".

These regulations address the health and safety aspects in U.S. law relating to the use of electricity and electrical equipment in the workplace. It is proposed in this article that the above regulations cover much of the safety goals the EU Low Voltage Directive is intended to. In fact the above U.S. regulations address general health and safety requirements and practices in much more detail than does the LVD, as there are separate regulations in the EU for workplace health and safety.

It can be seen that the LVD directly refers down to the lower level regulatory requirements – the harmonised standards themselves – and for example EN 61347-2-13:2006 Lamp control gear – Part 2-13: Particular [safety] requirements for d.c. or a.c. supplied electronic control gear for LED modules – is a harmonised standard listed in the Official Journal of the European Union.

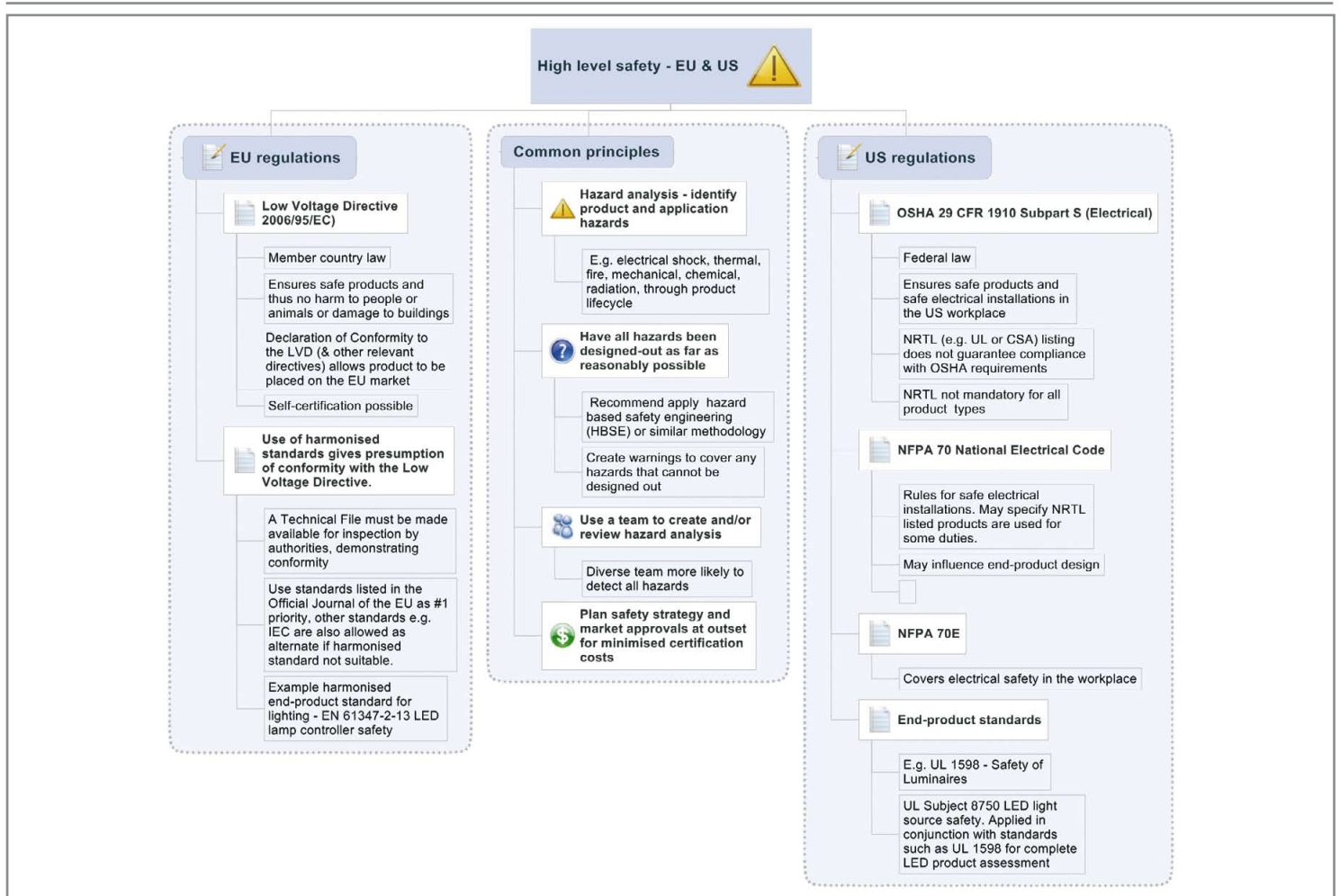

Figure 2: High-level safety regulations and principles.

And as a comparison with the U.S. system the lower level requirements – the standards themselves – are called up by the OSHA and NEC regulations, which require the use of the appropriate American National Standards (ANS). ANS are standards developed by Standards Development Organisations (SDOs) that work to American National Standards Institute (ANSI) guidelines to ensure the quality and consistency of the standard development process and that the standard has been developed by consensus of interested parties.

The ANS covering the electrical, fire and mechanical hazards for the lighting sector are those developed by Underwriters Laboratories (UL). UL has developed many lighting standards as of course this industry sector is one of the oldest in the electrical engineering field. There are currently approximately 27 lighting related product standards published by UL – from somewhat obscure examples such as UL 1230 for the Safety of Amateur Movie Luminaires – to the widely used UL 1598 Standard for the Safety of Luminaires, and of course through to the currently topical Subject 8750 – LED Light Sources for use in Lighting Products – which is under development (and as a side-note is used in conjunction with appropriate existing UL end-product lighting standard in order to fully evaluate the complete LED based end-product).

The OSHA regulations can be considered to be at the centre of the U.S. electrical safety requirements and constitute federal law. The outcome of a lawsuit may end up being decided over the interpretation by experts of a particular federal code requirement. One can locate expert witnesses that specialise in knowledge of a particular OSHA code regulation, and that publicise their expertise and court procedure experience to product liability Attorneys looking for this assistance.

The NFPA 70 (NEC) should be used for its advisory role on implementing safe electrical installations and using safe products (such as when certain products must be listed by a Nationally Recognized Testing Laboratory – NRTL), whilst the NFPA 70E standard will give employers guidance in safe working practices to be observed during equipment installation and ongoing once the installation goes into service and is then subject to normal maintenance and operation procedures.

NEC article 410 lays down many of the requirements for luminaires, lampholders and lamps including for example specific references to installation practices for LED luminaires installed in closets (article 410.16). Article 411 is also worthy of reference as it applies to lighting systems operating at 30Vac or less (30Vac / 42.4Vpk being the limit for a circuit considered not to present a risk of electric shock according to U.S. requirements). Article 411 has important definitions regarding listing requirements (such as UL or other NRTL listing) of low voltage lighting systems.

#### Nationally Recognized Testing Laboratories

Typically manufacturers may immediately think of obtaining UL (Underwriters Laboratories) 'approval' for their product in order to launch their new product design onto the U.S market – but this is not a sufficient approach on its own because the important higher level regulatory review would have been missed out. In many cases UL or an alternative NRTL evaluation may prove to be needed as established by the high level review

but do not assume that NRTL listing is mandatory until this aspect has been researched – other routes may be perfectly permissible. For example installation of a one-off custom designed system to be installed at a fixed end-customer site may not need listing, although it will be wise in such a case to liaise with the local Authority Having Jurisdiction (AHJ) to ensure a non-listing approach is acceptable.

It is an appropriate point to explain some terminology and requirements. Firstly UL 'approval' – a commonly used term but incorrect according to UL definitions – should be clarified as UL listing, recognition or classification. Generally, the UL listing mark (the letters 'UL' in a circle) applies to an end-product such as a complete luminaire ready for wiring to a building electrical circuit, whereas the UL recognition mark (the letters UR written backwards) applies to components that are to be used inside end-products (for example some LED light modules are now appearing with UL recognition). Classification is a less commonly seen UL marking and covers more specialised evaluations such as to a unique set of application requirements. It is much easier to gain UL listing for an end-product if safety related components used are UL recognized. Recognized components have undergone constructional assessment and testing within certain conditions – and provided they are used in an end-product within the recognized conditions (known as 'conditions of acceptability'), then further assessment at end-product level is minimised. Another point which should be made clear is that UL is one of several NRTLs and manufacturers should be aware that product safety listings can be carried out by any NRTL that is accredited by OSHA against the relevant product category and standard so there is choice in the marketplace.

NRTLs are appointed and administered by OSHA which is a section of the U.S. Government's Department of Labor.

Authorities Having Jurisdiction (AHJ) with regard to electrical product and installation safety, may be a number of different organisations at local level, e.g. part of an NRTL, or a staff member employed by a city or municipality department responsible for such duties. An AHJ inspector can 'red-tag' (prevent from use) an installation or equipment if the inspector find a problem – for example with non-compliance to the National Electrical Code, or a deviation from a manufacturer's installation manual or UL/NRTL listing or condition of acceptability violation.

As well as originally being located in the U.S., NRTLs can now be found in many other countries – which involves OSHA staff travelling to the NRTL location to carry out initial qualification of the NRTL and perform regular auditing. With regard to CE marking, for most product categories, including many types of lighting product, self-certification application of the CE mark can be done entirely by the manufacturer without third-party involvement equivalent to an NRTL. Some more specialised markets such as products designed for use in explosive atmospheres, will require mandatory third-party certification by EU accredited laboratories. The official term for such organisations is a 'Notified Body' and they are appointed by each EU member state.

## Summary

The high level European safety legislation in the form of CE marking to the requirements of the Low Voltage Directive may be considered as giving the manufacturer more flexibility in demonstrating mandatory conformity requirements compared with the higher level requirements of the U.S. system which in many more cases will involve the judgement of a third-party such as an NRTL and/or a local Authority Having Jurisdiction before the item is placed on the market or installed. This is because the European system allows self-certification by the manufacturer for most categories of products. This should not prompt conclusions as to whether products meeting European safety requirements are safer than those meeting U.S. requirements or vice-versa. Such generalisations cannot be easily or reliably made. The important point is to understand the requirements in detail for whichever market is targetted and devise methodologies of ensuring the design process results in a safe product at minimal conformance cost and in the least possible time. Design for safety should be planned at the outset of a development project and not left to the final stages of the project.

The highest level legal requirement with product safety is the expectation of the law that the manufacturer will place a safe product onto the market. This means that the manufacturer must design-out all product hazards as far as possible, and if there are any hazards that cannot be designed out, they must be brought to the attention of the relevant parties – user, installer, service person, repairer, re-cycler (different hazards may be present depending on the usage mode of the product and the lifecycle stage). This last area is usually addressed by appropriate warnings on the product labels, and in the supplied product documentation. Whilst the safety standards lay down certain requirements and give actual text to be used in some cases, these warnings may not be sufficient and the manufacturer may need to develop additional special warnings particular to the possible hazards presented by the use of the product. Many manufacturers, particularly in the U.S., now routinely engage the service of a specialist Attorney to define the exact wording. This can be crucial to building a robust litigation control scheme to help guard against 'nuisance' or 'speculative' lawsuits, or other potential legal actions that may arise once the product is on the market.

A particular safety hazard that should be considered from a high level regulatory perspective before undertaking detailed safety requirements research is that of possible injury to the eye through excessive light intensity that may be emitted by an LED; especially with a rapidly increasing luminous intensity performance being seen in the latest LED technology. Legislation and safety standards are being developed to address this but until guidelines are clear, manufacturers will have to do their own additional due diligence, ultimately to be able to show to authorities if required, that they have considered and addressed such hazards and that eye damage will not result through use of the product. From the hazard analysis point of view, one should consider single component faults (multiple component faults for safety critical applications) and whether for example the expected maximum light intensity could be exceeded e.g. due to a fault in the driver circuit.

Newer standards in development such as IEC 62368 in the consumer electronics field, which is intended to replace EN 60950 for Information Technology Equipment and EN 60065 for Audio/Visual product safety, bring in the concept of Hazard Based Safety Engineering (HBSE) and

place the emphasis on hazard assessment over technology specific standards. It will be interesting to see how this standard progresses. If it is successful, the HBSE methodology is likely to be adopted in other product safety standards. HBSE techniques can of course be applied now as a tool to analyze potential product safety hazards.

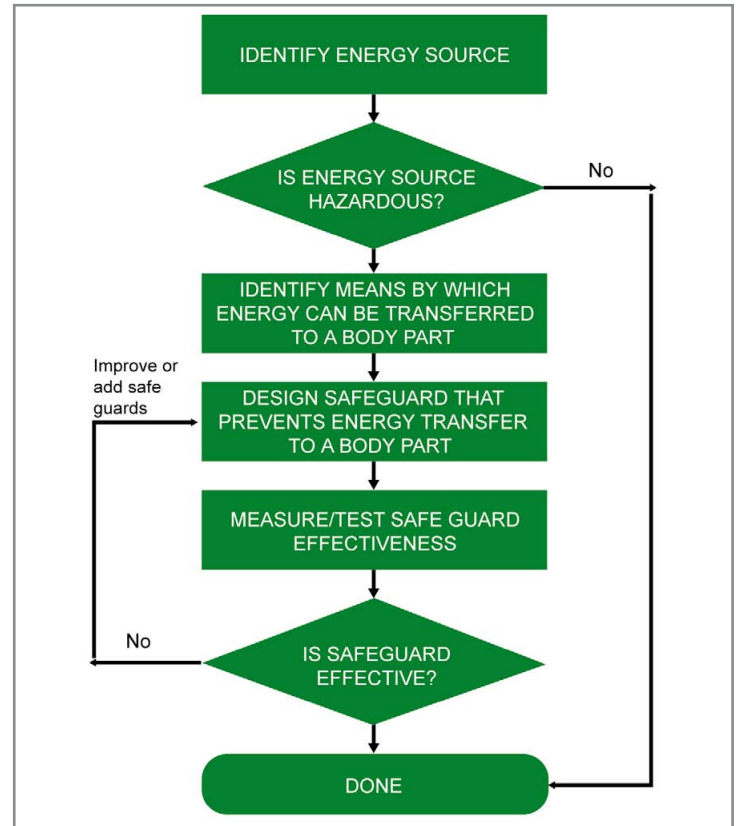

Figure 3: The hazard based safety engineering (HBSE) process.

This article has concentrated on the requirements of the European and U.S. marketplace, but meeting regulatory requirements for either, or both of these markets will allow sales to be made in many other counties which accept the CE mark and the U.S. NRTL safety marks. Many other certifications are possible such as the international CB scheme based on IEC standards, but whatever compliance route is taken, it is best to plan the approach early in the development cycle and start compiling the LVD Technical File, list of UL recognized components and other regulatory information early in the development phase. Key safety related tests should be identified and 'dry-run' before submitting the product design for final NRTL witnessed testing to avoid the risk of test failure, re-design and re-test and possible delayed product launch.

It is hoped this article has been thought provoking with regard to the importance of taking a high level view of how best to achieve a safe product design, and also possible ways to innovate in the compliance process just as with innovation in the design of the new LED lighting product itself. ■

#### References:

- EU Low Voltage Directive 2006/95/EC.
- Official Journal of the European Union.
- NFPA 70 - National Electrical Code 2008 edition.
- U.S. Department of Labor - OSHA 29 CFR 1910 Subpart S (Electrical) regulations.
- European Computer Manufacturers Association. IEC 62368 HBSE.



# LED CHINA 2010

— The Leading Global LED Event

Time : March 2 - 5, 2010

Venue : China Import and Export Fair Pazhou Complex, Area B (Guangzhou)



**LED CHINA**, the first global trading platform for LED chip, encapsulation, lighting, photoelectricity display, illuminant and equipment, etc. Owing to the great successes of previous editions, it has earned the reputation of an indicator of LED industrial development in the world.



**In year 2010**, LED CHINA, SIGN CHINA and NEON SHOW will be held under the same roof again. The total exhibition area will be up to 90,000 square meters with 1,000 exhibitors attending. LED CHINA 2010 anticipates gathering 400 exhibitors taking 30,000 sq. m. exhibition space.



 [www.LEDChina-gz.com](http://www.LEDChina-gz.com)

A perfect purchasing chain for global buyers gathers the leading LED enterprises with the most advanced products in China!

The online Visitor Registration is open. Act now to get the free show catalogue CD!

Trust Exhibition Co., Ltd.

Tel: +86-20-3810 6261, 3810 6263

Email: LED@TrustExhibition.com

Fax: +86-20-3810 6200

Website: [www.LEDChina-gz.com](http://www.LEDChina-gz.com)



## Technologies

# Low Cost of Ownership Lithography for High Brightness LED Manufacturing

> Douglas E. Anberg, VP, Advanced Stepper Technology, Andrew M. Hawryluk, Ph.D., CTO, Ultratech Inc.

The U.S. National Energy Policy calls for improvements in the energy efficiency of residential and commercial buildings and the U.S. Department of Energy (DOE) has identified more efficient, cost-effective artificial lighting as a key ingredient to meet this goal. If the DOE program reaches its goals, solid state lighting could result in a \$17B annual savings and a 4% reduction in U.S. annual energy consumption[1]. When considered on a global scale, energy savings are projected to be in the several hundreds of billions of dollars.

Manufacturing cost reductions are critical to the long-term success for large-scale implementation of Solid State Lighting (SSL). A key contributor to the more advanced HB LED processes for SSL applications is the cost impact of the lithography process steps. This paper discusses the economic and technical advantages of converting the HB LED lithography process from traditional low-capital cost contact and proximity aligners to modern projection lithography tools.

## Technology and Efficiency Improvements

In the past decade, LED efficiency has improved approximately 20-fold with a corresponding 10-fold decrease in cost per lumen (Haïtz's Law). Today, several commercial vendors report that they have produced white LEDs in excess of 100 lm/w in their labs. A typical target for the practical implementation of SSL by 2015 is to have commercial LED lighting products with ~160 lm/w [1]. Clearly, the technical progress in LED efficiency has been remarkable and the 2015 efficiency goals appear within reach.

To achieve high market penetration, a cost target below \$1-2/kilolumen will be necessary, which will require an additional 20-fold decrease from the cost of HB LEDs for lighting that are available commercially today. A 160 lm/w LED for SSL will therefore require an additional 20-fold decrease in costs while the theoretical maximum additional efficiency improvement is approximately 2x, and may be further limited by other device physics constraints such as current droop [2]. These additional cost reductions must therefore come from other sources.

## Learning from the Semiconductor Industry

Fortunately, the LED manufacturing process of today can take advantage of the lessons learned from the early process improvements developed for the semiconductor manufacturing industry, circa 1975. For both,

wafer sizes are 2-4 inches, process equipment for critical process steps tend to be highly customized (internally modified by LED manufacturers), deposition process control is a limiting factor in device performance and critical linewidths are a few microns. During the past 30 years, the semiconductor industry has implemented significant process improvements while decreasing overall device costs at an amazing pace, following Moore's law to become the flagship of manufacturing efficiency improvements.

Figure 1 illustrates the average selling price of a transistor between 1968 and 2008 as reported by Intel [3]. The average price of a transistor in 1975 (when minimum feature sizes were approximately 4 microns) was approximately \$0.02/transistor. In comparison, the average sales price of a transistor in 2008 (with minimum features sizes of approximately 45 nm) is \$5x10<sup>-9</sup> per transistor, or a cost reduction of 4,000,000x. The cost reductions from transistor size scaling were approximately 8,000-fold. The remaining 500-fold cost reductions came from manufacturing efficiencies.

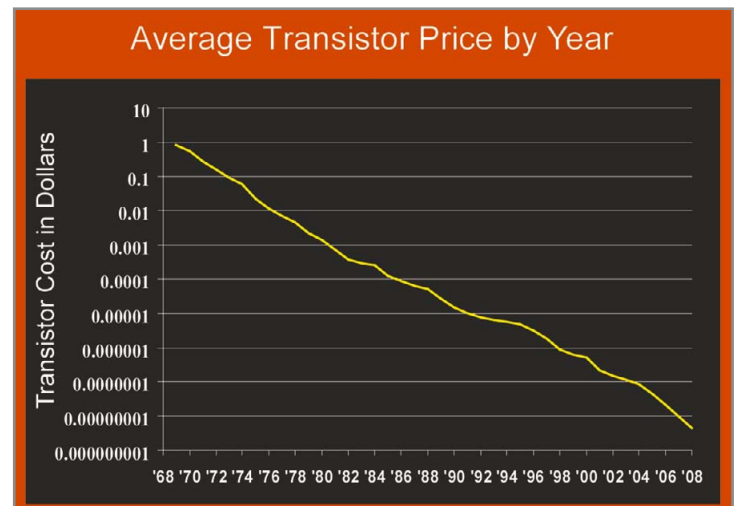

Figure 1: The historical trend for the average transistor price shows the continuous cost reductions achieved by the Semiconductor Industry [3]. Of the 4,000,000x cost reduction between 1975 and 2008, approximately 500x is due to manufacturing efficiency improvements.

Over the past 30 years, the semiconductor industry has achieved ~500x improvements in yielded silicon per unit time with corresponding cost reductions by driving improvements to capital equipment. Semiconductor capital equipment today is more efficient, more productive and less costly in terms of yielded silicon. The LED industry needs these types of cost savings to reach its cost targets and it cannot take 30 years to achieve them. Some of the cost-reductions for mature semiconductor manufacturing can be summarized in Table 1.

	Status in 1975	Status in 2008	Improvement
Wafer Size (mm)	50	300	36x
Throughput (wafer/hour)	~50	~200	~4x
Productivity (% uptime)	<50	>85	~2x
Yields (%)	<50	>80	~2x

Table 1: Estimated productivity improvements obtained by the semiconductor industry. Together, ~500x more silicon per unit time is yielded on today's capital equipment tools when compared to tools in 1975.



The final LED cost reductions are expected to come from a combination of improved LED efficiencies, higher driver current and lower manufacturing costs. Manufacturing cost reductions will come primarily from the factors shown in Table 1: Larger substrate sizes, improved tool productivity and improved process yields.

To meet the cost requirements for the SSL market, LED manufacturers and equipment suppliers must address the need for improved manufacturing tools for LEDs. Projection lithography tools for HB LED manufacturing will need to be implemented in process lines to improve yield and projection lithography tool manufacturers must implement improvements to material handling, automation and throughput while reducing capital equipment cost.

## HB LED Lithography Options

In the mid-1970's, contact and proximity printing was the primary form of lithography used to manufacture semiconductor devices. As the semi-conductor industry evolved to high-volume manufacturing on larger substrates with tighter device design rules, contact and proximity printing was replaced by projection lithography to address yield issues due to lithography process defects, as well as the linewidth control and layer-to-layer overlay limitations of contact and proximity aligners. Segal [4] reported:

"In the 1970s, defect-related yield losses were primarily a result of the cleanroom environment and the lithography process. Defects were caused by dust particles in the cleanroom, mask defects left over from the mask fabrication process, imperfections in the glass used as a mask substrate, and photoresist particles that were transferred from wafers to masks through direct physical contact [5]. By the mid-1980s, dust particles in the cleanroom were no longer the dominant source of defects. Meanwhile, contact printing had been replaced by projection printing, which is less vulnerable to defects."

At present, there are typically four to six lithography steps in a conventional LED manufacturing process and more may be added to increase the LED extraction efficiency. Many HB LED manufacturers currently use contact or proximity printers on 2 inch and 4 inch Sapphire wafers. As the HB LED design rules are tightened to improve light extraction efficiency, contact and proximity aligners can become the limiting factor in HB LED yields due to high defect densities, linewidth control and layer-to-layer overlay limitations.

With the yield improvements and wafer handling automation available on projection lithography tools, they quickly became the tool of choice for high-volume semiconductor manufacturing. A similar tool will be needed to support high-volume LED manufacturing. Fortunately, a projection lithography tool for LED manufacturing can be developed based on the tools designed for the early semiconductor applications.

The alternative use of projection lithography improves overlay, enables printing much smaller minimum feature sizes without introducing defects, and provides superior resist profiles for improved linewidth control. The effect of these process improvements is higher device yield, which directly impacts device cost.

## Contact and Proximity Printing Limitations

Contact and proximity printers place the mask in contact or close proximity to the wafer and use an extended source to illuminate the entire wafer; the shadow of the mask defines the structure on the exposed wafer, and the penumbra (shadow) limits the linewidth (Figure 2).

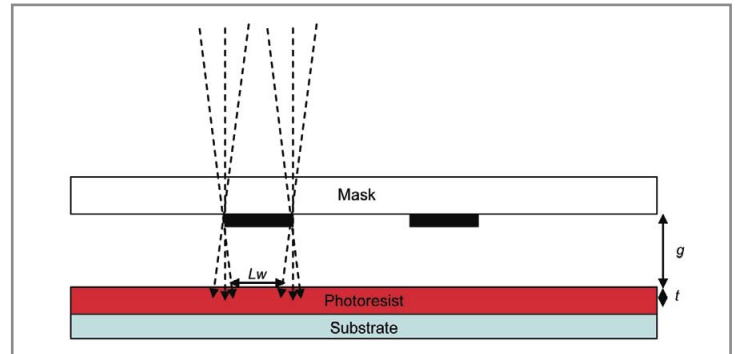

Figure 2: In proximity (contact) print lithography, the penumbra from the extended source and gap blur the image, limiting the linewidth and sidewall of the replicated structure.

The resolution of a proximity print process is given by [6]:

$$Lw = 1.5\sqrt{\lambda * (g + t)}$$

where  $Lw$  is the linewidth of the feature,  $\lambda$  is the exposure wavelength (approximately 400 nm),  $g$  is the mask to wafer gap and  $t$  is the photoresist thickness. In the case where the thickness of the photoresist is small compared to the gap, the equation can be simplified to:

$$Lw = 1.5\sqrt{\lambda * g}$$

For an aligner, the optimum exposure condition for the mask to wafer working gap setting is often a difficult compromise between near contact for best image quality and a large gap space to minimize mask and resist damage due to mask to wafer contact. Because the minimum resolution required for today's HB LED processes can be 5 microns or less, the aligner gap is typically set to approximately 10 microns or less.

2-inch sapphire substrates can have up to 50 microns or more of bow as a result of the MOCVD process used in HB LED manufacturing, while 4-inch substrates have been shown to exceed 100 microns of bow [7]. As a result, the mask will contact the substrate at various locations across the wafer, producing localized defects on the substrate being exposed. Additional defects are also generated on subsequent substrates when resist sticks to the mask and scatters light on subsequent exposures or transfers resist to the next substrate (Figure 3).

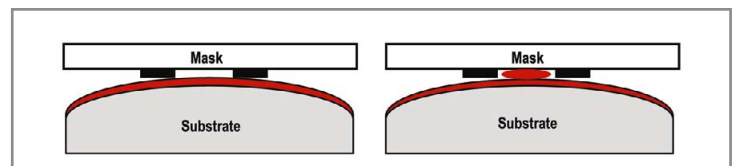

Figure 3: In proximity print lithography, the mask often comes into contact with the resist-coated substrate (left figure). The resist sticks to the mask and becomes a scattering (defect) site on subsequent exposures (right figure). The contaminated mask can also transfer resist to the next substrate, causing additional defects. Because each wafer may be uniquely warped, the mask may touch each substrate in a different location. After several exposures, the mask has accumulated many defects and must be cleaned or discarded.

The present solution used in LED manufacturing is to frequently clean the mask, and replace the mask after several lots have been processed. This procedure adds significant recurring mask cost and unpredictable yield loss due to mask generated defects.

The problem is exacerbated for larger diameter substrates as masks will be larger and more expensive, and the larger substrates may have more warpage, resulting in even greater yield losses.

## Projection Lithography and Yield Improvement

In projection lithography, a stepper uses projection optics to image a mask onto the substrate. The mask and wafer are separated by the projection optics and never come into contact. Figure 7 illustrates this concept.

The resolution of a stepper using projection optics is given by the Rayleigh criterion [8]:

$$Lw = \frac{K\lambda}{NA}$$

Values of K are resist dependent, but are typically 0.8 for standard illumination techniques. For a stepper with an NA (numerical aperture) of 0.3 and a wavelength of 436 nm, the resolution is 1.0 micron. 1X projection steppers (using a larger NA and shorter wavelength) are used in manufacturing with a resolution down to 0.8 microns. Notice that this is considerably smaller than linewidths that can be produced with contact or proximity printers with a fixed mask to wafer gap.

The depth of focus (DOF) of a projection optical system is given by the Rayleigh criterion for DOF:

$$DOF = \pm \frac{(Lw)^2}{2k^2\lambda}$$

where k is a constant, equal to approximately 0.7. Notice that the DOF scales with Lw, the minimum feature size. For 2 micron features, the theoretical DOF of the stepper is approximately +/-10 microns. The Rayleigh criterion are only strictly valid at the theoretical resolution limit of the projection optics, however they can be used as a general rule to estimate the DOF at larger geometries, where sidewall angle and resist process considerations eventually become the limiting process control factor. With this understanding, the DOF can be estimated to scale to approximately +/-62 microns for 5 micron features.

In a typical stepper, the projection system can re-focus from field to field, so the gap variations across the wafer are not relevant. Because the mask is never placed in proximity of the substrates, defects are not generated and the mask is never consumed. The elimination of defects from the lithography step with projection lithography provides higher yields than with contact or proximity print lithography.

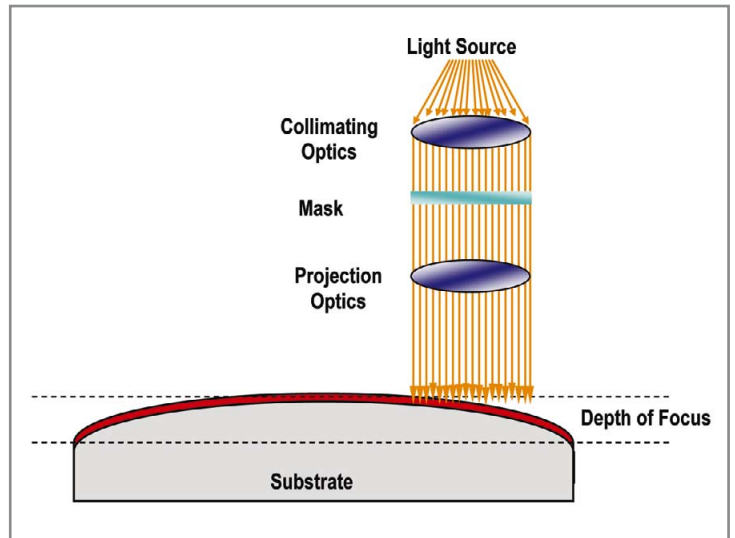

Figure 4: A stepper uses projection lithography to image the mask onto the substrate. Since the mask is separated from the substrate, defects from contact are eliminated. Resolution and depth-of-focus are determined by design parameters of the tool.

## Process Performance Improvements (Linewidth Control, Overlay and Resolution)

In addition to reducing defects, projection lithography is also known for improved linewidth uniformity and layer-to-layer overlay. Figure 5 [9] illustrates the CD uniformity (i.e., linewidth uniformity) for a pattern exposed by a stepper and an aligner on a silicon substrate. The stepper provides more uniform and reproducible linewidths which result in higher yields.

For LED substrates, wafer warpage can lead to variations in linewidth that are much greater when using contact or projection aligners than those shown in Figure 5 on silicon wafers because the LED substrates are rigid and typically highly warped. In the case of a stepper with a projection lens, the linewidth variation on the LED substrates will be minimal due to the ability to independently focus every exposure step.

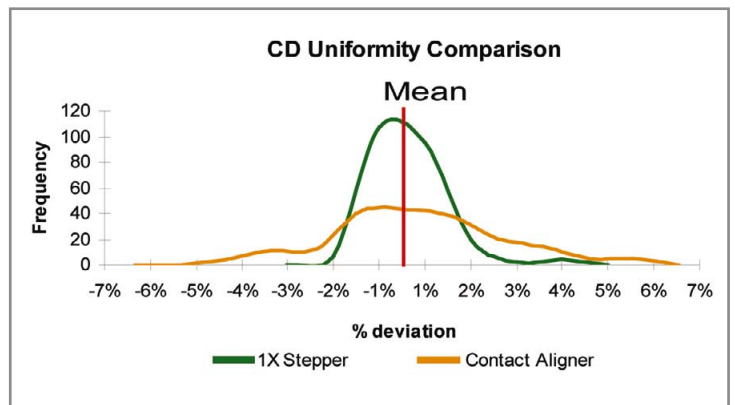

Figure 5: The CD uniformity from a 1X stepper is superior to a contact aligner. These results were from a 10 micron pattern on a silicon wafer [7].

Figure 6 [7] shows a comparison of overlay results on the same product exposed on a stepper and a contact aligner. Because each field is independently exposed and aligned, a stepper can correct for

many systematic wafer scale errors such as grid and orthogonality during the step and repeat exposure process [10]. As noted in the "Handbook of Semiconductor Manufacturing Technology" by Yoshio Nishi and Robert Doering [11]:

"One of the primary reasons for the introduction of wafer steppers as a replacement for full-wafer projection printers was to improve the overlay of pattern levels. The biggest source of errors in full-wafer tools were mask errors and wafer distortion errors due to processing", and "Steppers also allow local positioning in a small area on the wafer, thereby reducing the impact of process induced wafer distortions".

This unique stepper capability results in superior layer-to-layer overlay compared to the full-wafer exposures required with contact and proximity aligners. Overlay results on LED substrates can be degraded even further for contact and proximity aligners due to mask to wafer die position errors resulting from full-wafer exposures of warped substrates as shown in Figures 7 and 8.

1X projection steppers can provide production process resolution down to 0.8 microns with a large depth of focus while eliminating defects from the lithography process [12]. This represents a greater than 5x improvement in the practical production resolution limit of ~ 5 microns for aligners due to defect and linewidth control limitations.

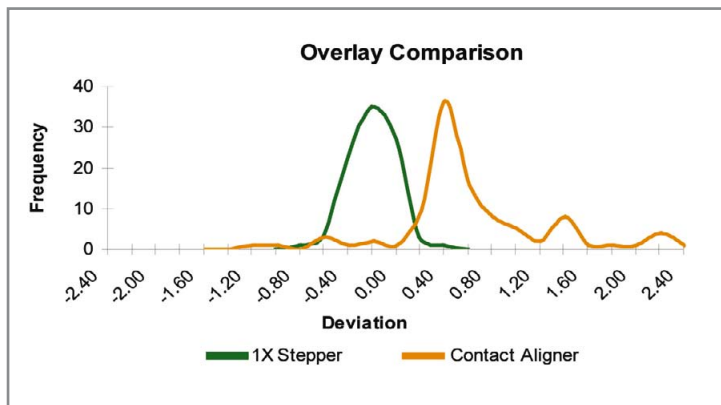

Figure 6: Comparative overlay results for a 1X projection stepper and a contact aligner. The overlay results from a stepper are superior to that of a contact printer[7].

## Warped Substrate Processing Considerations

One important key to advanced manufacturing is the ability to keep the substrate in proper focus throughout the exposure process. However, we are seeing increasingly larger warpage on LED substrates, and larger diameter substrates have even greater warpage. While 2-inch sapphire wafers can have warpage of 25-50 microns, 4-inch wafers often exceed 100 microns and 6-inch wafers can exceed 250 microns [6].

Schematically, the problem is illustrated in Figure 7 which shows a top and side view of the LED substrate. In the top view, we see the substrate populated with LED die (not to scale). In the side view, we illustrate the warped wafer and its impact on the location and orientation of three die across the warped substrate. Because of the warpage, the dies are tilted and are no longer located on a Cartesian grid.

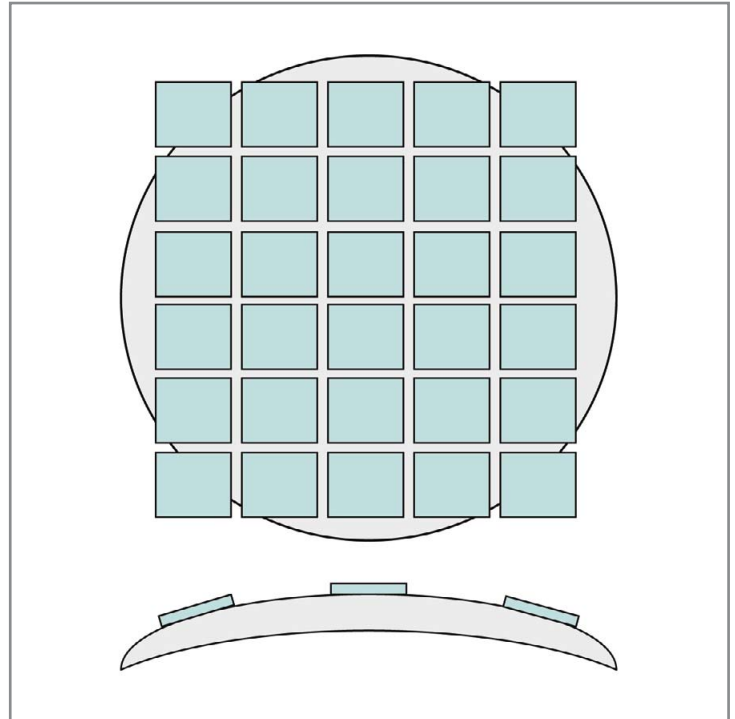

Figure 7: Top and side views of a LED substrate with die (not to scale) are illustrated here. Notice that the location and orientation of the die are effected by the wafer warpage.

Traditional lithography tools are not able to accommodate the substrate curvature illustrated in Figure 7. Nominal contact printers or steppers without topology correction capabilities will expose die as illustrated in Figure 8, where the red features illustrate the location and orientation of the exposure field. Notice that the exposure field may not be in focus and may be displaced relative to the die on the substrate.

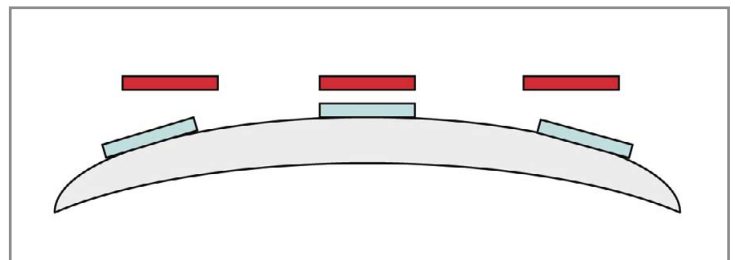

Figure 8: The orientation of nominal exposure fields (in red) relative to die on warped substrates in a conventional contact-print or in a stepper without topology compensation is illustrated. The exposures along the exterior of the wafer are misaligned, out of focus and are not parallel to the substrate.

It is possible for a stepper to compensate for topology which will allow the stepper to properly expose patterns onto warped substrates. Topology compensation can be accomplished by first mapping out the warpage profile of the wafer and locating the alignment features associated with each die. By adjusting the wafer tilt and the focus of the system, it is possible to align properly and to expose features as illustrated in Figure 9. As warpage increases with larger wafer sizes, the ability of the lithography tool to compensate for substrate warpage becomes even more critical. Mask to wafer contact using aligners can occur over a larger area on the larger substrate, resulting in greater yield loss due to mask contact induced defects.

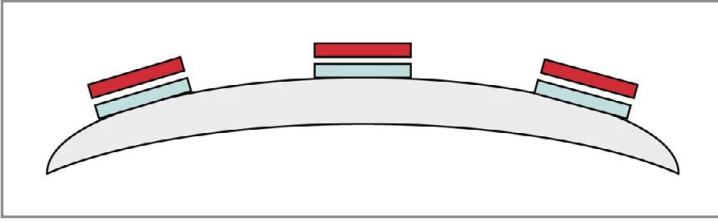

Figure 9: Exposures with topology compensation can place the exposed field in the proper location and orientation relative to the warped wafer.

## Total Cost-of-Ownership Reduction with 1X Projection Lithography

The concept of Total Cost-of-Ownership (CoO) has become a fundamental principle for determining the most cost effective solution for capital equipment purchases and process implementation in high volume semiconductor manufacturing fabs (see SEMI standard E35 'Cost of Ownership for Semiconductor Manufacturing Metrics'). As noted by SEMI in their announcement of the U.S. DOE's publication of a solid state lighting manufacturing roadmap focused on cost reduction, CoO is the total cost of producing a good part from a piece of equipment, which is obtained by dividing the full cost of the equipment and its operation by the total number of good parts produced over the commissioned lifetime of the equipment [13]. At present, the CoO for a projection tool vs. a contact or proximity print tool are comparable when mask costs are included, and superior when yield improvement on HB LED products is considered. Figure 10 shows the significant cost savings that can be achieved with only moderate die yield improvements using projection lithography to eliminate contact or proximity aligner induced defects.

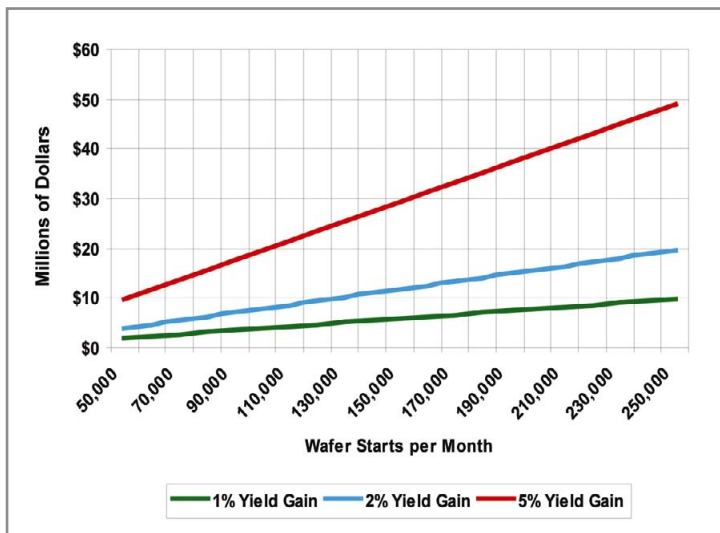

Figure 10: Potential cost impact for 1, 2 and 5% yield gain from converting a HB LED process to projection lithography for 4-inch Sapphire wafers. This analysis assumes a finished 4-inch wafer cost of \$300 and 7,500 gross die per wafer.

Further optimization of LED process equipment by customizing the HB LED tools to include only those features required for LED processing can further improve the total CoO. The productivity improvements to the tool (relative to an existing projection lithography tool) will be

measurable in terms of throughput and tool utilization and will drive the of CoO improvements. Table 2 shows the total CoO can be reduced by 2x for 4-inch wafers and 2.5x for 6-inch wafers over the existing semiconductor projection lithography tool by providing a tool customized for the HB LED market.

4 inch Wafers	Throughput (Wafers/hour)	5-Year Maintenance Costs	Capital Equipment Costs	Cost of Ownership
Semiconductor Stepper	63.9	\$26,020	\$1,600,000	72.6¢/wafer
HB LED Stepper	78.6	\$11,920	\$1,000,000	36.1¢/wafer

6 inch Wafers	Throughput (Wafers/hour)	5-Year Maintenance Costs	Capital Equipment Costs	Cost of Ownership
Semiconductor Stepper	37.5	\$26,020	\$1,600,000	124¢/wafer
HB LED Stepper	60.1	\$11,920	\$1,000,000	47.2¢/wafer

Table 2: Performance and cost improvements to a stepper designed specifically for the HB LED process. Throughput is calculated for 4 and 6-inch wafers with a resist sensitivity of 1500 mJ/cm<sup>2</sup>. For 4-inch wafers, the CoO is improved 2x over the standard projection tool. For 6-inch wafers, the CoO is improved 2.5x.

## Conclusions

To meet the SSL lighting market requirements, it will be necessary to reduce the cost of every aspect of LED manufacturing. Increasing LED efficiency alone will be insufficient to meet the >10x reduction in cost required per lumen. LED manufacturing costs themselves must be driven much lower. Lithography is used between 4-6 times during the fabrication of HB LEDs and when yield impact is considered, lithography is a significant cost center in LED manufacturing. Conversion of HB LED lithography processes to projection lithography, especially 1X lithography steppers designed specifically for the HB LED process, can contribute significantly to the overall device cost reduction for worldwide adoption of solid state lighting. These cost reductions will result from total cost-of-ownership improvements driven by improved yields, higher throughput and reduced mask costs that are achievable with 1X projection lithography equipment. ■

### References

- [1] Pitsor, Kyle (September, 2003) "Next Generation Lighting Industry Alliance Handout Sheet"
- [2] R. Stevenson "The LED's Dark Secret", IEEE Spectrum, August 2009
- [3] Intel/WSTS, 8/07
- [4] J. Segal, L. Milor and Y. Peng; "Reducing Baseline Defect Density Through Modeling Random Defect-Limited Yield" <http://www.micromagazine.com/archive/00/01/segal.html>
- [5] W. Maly; "Modeling of Lithography-Related Yield Losses for CAD of VLSI Circuits"; IEEE Transactions on Computer Aided Design, 4, no. 3, (1985)
- [6] C. Mack, Fundamental Principles of Optical Lithography, Wiley, 2007, p. 19
- [7] E. Armour, F. Lu, M. Belousov, D. Lee and W. Quinn; Semiconductor Today, Compounds and Advanced Silicon; Vol. 4, Issue 3, April/May 2009.
- [8] H. Levinson, Principles of Lithography, SPIE Press, 2001, p. 38
- [9] D. Anberg, M. Eguchi, T. Momobayashi, T. Wakabayashi, T. Miyamoto, "1X Broadband Wafer Stepper for Bump and Wafer Level Chip Scale Packaging (CSP) Applications", 2000 Pan Pacific Symposium, SMTA (Surface Mount Technology Association)
- [10] H. Levinson, Principles of Lithography, SPIE Press, 2001, p. 200
- [11] Y. Nishi, R. Doering, "Handbook of Semiconductor Manufacturing Technology", 2nd edition, 2007, p. 472.
- [12] G. Flores, L. Dwyer, W. Flack, "Lithographic Performance of a New Generation i-line Optical System," SPIE 1927, 1993 Proceedings
- [13] U.S. DOE Publishes Solid State Lighting Manufacturing Roadmap, [http://www.semi.org/en/CTR\\_032119](http://www.semi.org/en/CTR_032119)



## The best solutions for any LED measurement application!

Whether you are designing or using LED luminaires, arrays, or displays, an accurate characterization of visual performance is vital to assess design choices, to make device selections, and to improve system performance.

Radiant Imaging provides the most extensive set of luminance and color measurement solutions in the industry specifically designed for LED applications. Source Imaging Goniometers for measuring near-field models for optical design. ProMetric Imaging Colorimeters for measuring illumination distributions. Imaging Spheres for measuring luminous intensity distributions. And a broad array of ProMetric Application Software for laboratory, factory, and field applications - including LED video display correction.

These measurements solutions provide you with the best fit to your application - saving time and reducing cost. And with a shared technology base and world-class technical support, Radiant Imaging solutions are easily extended to new applications.

For more information on Radiant's suite of LED measurement solutions, contact us at +1.425.844.0152 or [sales@radiantimaging.com](mailto:sales@radiantimaging.com).

Ask for a copy of our White Paper on LED measurement applications!

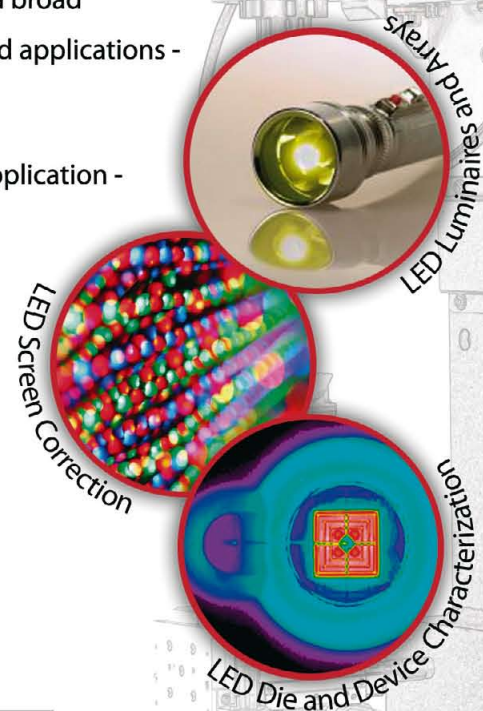

LED Luminaires and Arrays

LED Screen Correction

LED Die and Device Characterization

**RADIANT IMAGING**

## Optics

# Practical LED Light Measurement

> Wolfgang Dähn, General Manager, Bob Angelo, General Manager, Gigahertz-Optik

Solid state lighting employing Light-Emitting Diodes (LEDs) is evolving and transforming the entire world of lighting. Tremendous progress in the development of functional high efficiency high power white LEDs has made it possible to employ them in general lighting fixtures replacing traditional bulb and other type lamps. An LED luminaire or fixture is constructed by combining many single LEDs in a matrix configuration. Since the human eye is extremely sensitive to differences in color and intensity of lighting devices when placed side by side, tolerances in intensity and color temperature become critical. This article describes measurement technologies and quantities useful for LED qualification as well as the description of a LED lightmeter for industrial use.

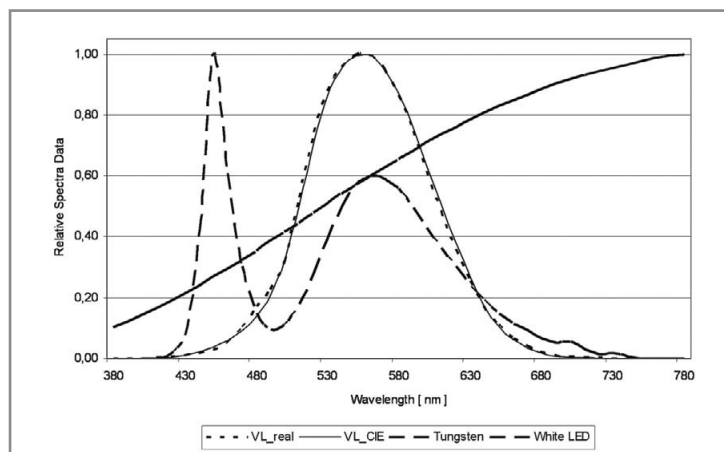

Figure 1: CIE and typical filtered detector  $V(\lambda)$  response with tungsten lamp and white LED emission spectrum.

The low tolerance variations required LED manufacturers to respond by improved processing technologies and compensation for any remaining differences caused by the sorting and binning of the LEDs. Due to the high volume production demands the measurement process had to be fast with the LED under test under operation for only a few milliseconds. As with any light source the LED light and color specifications are effected by operating temperature. That's why for best accuracy the light source under test is burned-in to a stable operating temperature before measurement. In the LED sorting measurement process which lasts only a few milliseconds per LED the junction and phosphor temperature of blue LED stimulated white LEDs will be much cooler as compared to the operation temperature in the actual application. This difference between sorting test and operation temperature seems to be the reason that upon visual inspection unacceptable variations in the finished assembled LED matrix are noticed. Since high volume LED sorting by the manufacturer cannot be done under real operation conditions the LED processing industry requires measurement technology that supports sorting and qualification at the implementation stage.

## LED Intensity and Color Measurement Devices

Traditional light and luminous color meters are built with photometric  $V(\lambda)$  and colorimetric RGB filtered detectors. The spectral response of these detectors are made to match the CIE and DIN standardized  $V(\lambda)$ ,  $Y(\lambda)$  and  $Z(\lambda)$  spectral functions as close as possible. For decades the filter photometer has been the basic tool for all kinds of light measurement applications in research and industry. Filter photometers and luminous color meters are typically calibrated with CIE Standard Illuminant A calibration lamps which are tungsten halogen lamps operated at 2856°K. Test light sources with a similar broadband, continuous with low blue spectral content emission spectra can be measured using the filter photometer with acceptable measurement uncertainties. However, measurement uncertainties increase significantly for light sources with a different spectral distribution than the calibration source like fluorescence tube lamps (FTL) and compact fluorescence lamps (CFL) which have higher blue spectral content. This is due to the filter photometer spectral mismatch error. Quasi-monochromatic LEDs and blue LED stimulated white LED emission spectra are totally different than that of the calibration source and may create further unknown increases in measurement uncertainty. Note that filter photometers are still widely used and do an excellent job when properly specified and applied. Plus their large linear dynamic range and fast response time makes them irreplaceable for several applications.

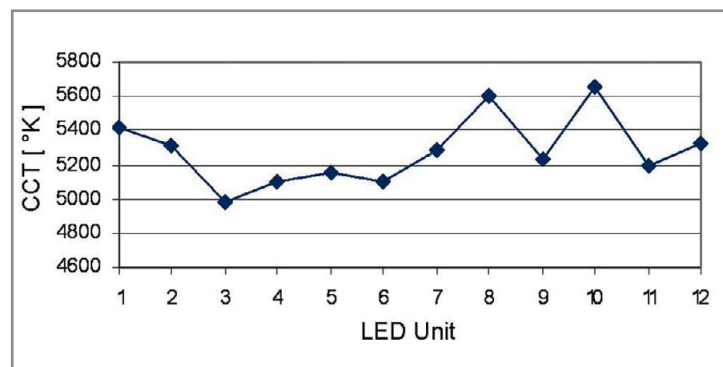

Figure 2: Measured color temperature uniformity of LED manufacturer sorted single white LEDs within a LED array.

Current state of the art LED intensity and color measurement devices employ spectral measurement technology. This type of instrumentation falls into the three categories: scanning grating monochromator spectroradiometer, diode array spectrometer and BiTec™ light analyzer.

Scanning grating monochromators represent the high end in light measurement instrumentation due to their excellent monochromatic light separation capability with low stray light ratio. The absolute intensity and color properties are calculated using the spectral data measured. This type of spectral radiometer is usually not portable, slow, expensive and complex and therefore not practical for regular everyday industrial applications. They are normally used as reference measurement devices in calibration laboratories and in research & development.

Diode array spectrometers, the alternative spectral measurement method offers fast one shot measurement of light source emission spectra. But they have limitations in absolute scale light measurements due to inherent pixel non-linearity effects and monochromatic separation is not as good as the grating monochromator due to stray light. These effects can be reduced to acceptable levels but only through extraordinary measures in the form of

active array cooling, dark signal compensation with electro-optical shutters and other methods. Beside the added cost aspect these add-ons increase the instrument footprint and power consumption which then restricts their use to stationary set-ups like the grating spectral radiometer.

The third and newest category is the BiTec™ sensor which combines a diode array spectrometer with a fast high precision filtered photometric detector. This method exploits each sensor technology's advantages and compensates for each technology's inherent shortcomings. Light intensity is measured with the photometric filter detector and the spectral data with the diode array spectrometer. Both sensors are mounted onto a small integrating sphere so no light guide is needed making it a hand-held and portable meter. The integration time dependent pixel offset signal of the diode array limits the signal to noise ratio and therefore the quality of spectral and color readings. A kinetic remote shutter for on-line offset compensation without the need for active array cooling helps compensate for this effect.

The applicable measurement type and associated units are just as important as the measurement technology in LED qualification.



Figure 3: BiTec sensor technology enables compact size portable LED measurement devices with compact integrating spheres to measure luminous flux and color data of assembled single LEDs.

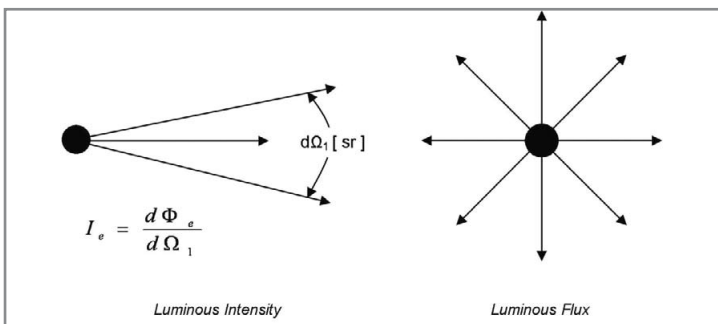

Figure 4: Luminous intensity and luminous flux.

## Luminous Intensity Measurement

Luminous intensity is a common measurement employed by LED manufacturers. Luminous intensity quantifies the luminous flux emitted by a source in a certain direction and is measured in lumens per solid angle or candela (cd). A uniform light distribution is assumed. To comply with photometric principles the measurement distance between source

and detector must be at least 10 times the maximum dimension of the source. In practice the measurement is complicated due to the need for precise distancing and axial alignment of the detector in front of the LED test sample. Be aware that the manufacturer luminous intensity specifications can only be reproduced if the measurement geometries are identical or if the LED exhibits a uniform spatial flux distribution. If the flux pattern is not uniform the total flux cannot be calculated using the luminous intensity data. Different solid angles during the measurement may also affect differences in the color data because of typical LED color variation in certain directions.

## Luminous Flux Measurement

Luminous flux measured in lumens is the basic photometric quantity and describes the total amount of light emitted by a source. It therefore precisely indicates the LED efficiency in electrical power to luminous flux ratio so it is used as the control parameter for color data under different operating conditions. Total flux measurement is a practical and repeatable type of measurement for the qualification of single unassembled LEDs, single mounted LEDs, LED arrays and lensed LEDs.

For well collimated parallel beam sources total flux can be measured using a flat planar photo detector with an active area larger than that of the beam diameter. But since most LED sources emit in a divergent beam or in a hemispherical pattern different measurement set-ups are required to capture the emitted light from all directions.

The most common device used to capture total flux for measurement is the integrating sphere. It is comprised of a hollow sphere that produces a uniform light density distribution on its internal spherical surface that is independent of the incoming light source spatial emission distribution. As a result a detector mounted on the sphere will detect the integral of the omnidirectional flux. This is only a simplification of the sphere operating principle. In practice integrating sphere and sphere system designs can become complex based on the individual application. One of the main design criteria of an integrating sphere is its size which depends mainly on the size of the source to be measured. The sphere should be large enough so that any error effects from internal baffles and test sample self-absorption errors are minimized. On the other hand since sphere size is directly related to attenuation level small size spheres are preferable when low flux light sources such as LEDs powered operated with low currents need to be measured. One other important design criteria is the self-absorption effect caused by the test sample itself placed at the sphere measurement port or inside the sphere. Light throughput and therefore the sensitivity of the measurement device can change up to several percent due to this effect adding more measurement uncertainty. Auxiliary lamps mounted on the sphere are essential for correction of any self-absorption effects.

For single LEDs the CIE recommends a minimum 200mm diameter integrating sphere detection system. By performing alternative calibrations of the sphere system much smaller sphere diameters down to 50mm can be used. The LED must be inserted into the measurement port of the integrating sphere so that all light emitted enters the sphere. For flux and color measurement of assembled LEDs a cone adapter which in effect stretches the sphere can be placed over the LED to isolate it for measurement and avoiding conflict with other components assembled around the test device. The measurement port size of the sphere should be small in relation to the sphere diameter to limit light loss and disruption of the light distribution within the hollow sphere.



Figure 5: Cone adapter to 'stretch' the integrating sphere isolates assembled LEDs for test.



Figure 6: Large diameter integrating sphere with large measurement port enables the measurement of the total flux and averaged color data of LED arrays.

## Illuminance Measurement

Illuminance measured in lux is a simple way to qualify a finished LED luminaire. Illuminance information is also useful for architects and lighting designers who need to know the level of available light incident on a surface at some distance away from the light source. If the luminaire can be considered a point source where the largest source dimension is ten times the source to detection distance then the illuminance readings can be used to calculate candlepower. Spectral measurement devices which can also deliver color information are being used more in illuminance applications for better accuracy when testing different types of light sources and LEDs.

## Spatial Light Distribution Measurement

Where the spatial light distribution characteristic is important goniometric measurement set-ups are used. Calibrated systems can measure in absolute units like angular luminous intensity distribution for example. The total flux can then be calculated by the summing the luminous intensity distribution values. The typical goniometric measurement set-up for LEDs is built with two rotary tables supporting the orientation of the test LED in Phi and Theta axes to the detector. The detector size and the distance between LED and detector form the solid angle in which the luminous intensity is measured. Because of the mechanical drive systems and the need to stop and take a measurement at each angle goniometric measurement devices are slow and expensive. Goniometers are typically used if spatial distribution data is an essential quality control factor, for example to qualify the light beam profile of luminaires that must direct light in a certain direction like street or parking lot lighting.

## Summary

Measuring LED color properties is a high priority in the production of LED fixtures. Most LED manufacturer datasheets will include color data like color coordinates, color temperature, color rendering index (CRI), color purity or color deviation. As stated earlier, color is most accurately measured with a spectral measurement instrument. The various color properties are calculated using the measured spectral data. But once assembled into the fixture the individual LED color specs could change causing a noticeable variation in color within the luminaire. For white LEDs the critical color parameters for matching are color temperature and CRI. Slight variations in color temperature will create an uneven lighting effect. In display or accent lighting the white LED is highly desirable for clean lighting but if the CRI is not optimal this type of lighting can detract from the subject appearance. Often at the implementation stage it is more beneficial and practical to qualify the LEDs relative to each other rather than in absolute terms.

## Conclusions

In LED implementation applications if only one type of measurement instrument could be chosen it would be a luminous flux and color meter with illuminance capability option. This type of meter can support LED qualification through all the different phases of production including measurement of:

- Single unassembled LEDs for incoming inspection and sorting purposes
- Single assembled LEDs to detect any changes due to the soldering process and the heat sink effect of the pc board
- LED arrays before assembly into the luminaire
- Single LEDs or LED arrays with front lens or optics to measure the influence and efficiency of the optic
- If illuminance data needs to be supplied with the final LED luminaire a qualified LED luxmeter would be needed

For increased flexibility modular light meters that enable accessories to be attached and interchanged such as different size integrating spheres and illuminance diffusers help to reduce instrumentation costs. ■



# The gateway to success in Asian market

Most promising exhibition in the lighting industry.  
500\* exhibitors and 25,000\* visitors gather.

(\* expected)



*Lighting Devices*

*Equipment*

*Components*

*Materials*

## 2nd **LED/OLED** Lighting Technology Expo

**LIGHTING JAPAN**

Dates : April 14 [Wed] - 16 [Fri], 2010

Venue : Tokyo Big Sight, Japan

Organised by : Reed Exhibitions Japan Ltd.

**More Information >>> [www.lightingjapan.jp/en/](http://www.lightingjapan.jp/en/)**

Organised by

 Reed Exhibitions

LIGHTING JAPAN Show Management, Reed Exhibitions Japan Ltd.

18F Shinjuku-Nomura Bldg., 1-26-2 Nishishinjuku, Shinjuku-ku, Tokyo 163-0570, JAPAN  
TEL: +81-3-3349-8568 FAX: +81-3-3349-0598 E-mail: light@reedexpo.co.jp

# Photometric Measurements in Modern LED Based Optical and Illumination Systems

> Juergen P. Weisshaar, General Manager, Uta Vocke, Marketing Manager, opsira GmbH

## Introduction

The use of LEDs for signalling applications started about 35 years ago. Over a period of 15 years only coloured LEDs were available. During the first years the LEDs were mainly used to indicate certain conditions of devices. Neither the total luminous flux nor the luminous intensity distribution was of great interest for the users of the LEDs. Even the colour or spectral distribution respectively was never of great importance for the first applications.

The first LEDs didn't even achieve the luminous efficiency of standard incandescent bulbs with only a few lumens total flux per Watt electrical power.

The availability of higher luminous efficiencies among the coloured LEDs as well as the launching of the first white coloured LEDs around 1990 made the LEDs more and more interesting for a very wide range of products in the sensor industry, display and signalling applications as well as illumination systems.

Nowadays LEDs, coloured or white, are surpassing the incandescent and halogen bulbs regarding their luminous efficiency and most probably they are on their way to beat even the fluorescent tubes soon.

However, price, thermal issues and the reliability of the high power LEDs lead to a tremendous amount of extra effort during the design and manufacturing of LED based signalling or illumination systems.

## Necessity of Photometric Measurements

Why are photometric measurements that important with respect to LED illumination systems?

There are three major needs for photometric measurements during the design and production phase of an LED-driven product.

- Measurements to qualify and quantify the LED's photometric performance to obtain all the photometric data needed to realize the optics development.

Based on the gathered data of the first measurements the optics designer is able to create the optics design for the specific requirements of the project. The optimization and the first verification of the design are typically done by computer simulation. The next step is the production of a prototype or some sample parts to verify the photometric performance in real terms. This leads to the second need of measurements:

- Measurements to qualify and quantify the photometric performance of the LED-driven optical system to verify its photometric properties against the specifications determined for the optics development of the product. In particular with LED based systems, not only the photometry but also the thermal management is of high importance.

If these measurements do not correspond to the desired performance and thus do not comply with the system specification, another development loop may be necessary. In the worst case the complete procedure starts again with the search for another appropriate LED type to achieve the specified results. In the majority of the cases, however, the system works properly or only minor modifications of the optics design have to be done.

LEDs require a much more sophisticated thermal management in comparison to the traditional light sources to ensure the photometric performance as well as the required life time. Total flux and colour of LEDs are changing as a function of their forward current and their temperature. This means that for high level applications, e.g. medical lighting or traffic lighting, the complete LED characteristic map as a function of the LED current and temperature has to be determined in order to run the later product in a reliable way. More and more the systems have to be calibrated regarding their current-temperature-flux-colour behaviour.

The next step after the prototype has passed all the tests is the mass production of the optical system. While the first prototypes of a new system typically are put together with high diligence, the situation changes in mass production.

Processes and materials or parts have to be optimized to achieve the best value creation possible with the product. The higher the mass production volume is the more optimization in terms of process or materials is tried to be established. It is not unusual that these actions taken lead to a loss in quality of the complete system and thus to a change of the photometric performance.

This leads to the third major need for photometric measurements:

- Measurements to ensure the photometric performance in mass production.

There is a noticeable trend during the last years towards a 100% photometric production control of optical or lighting products. While in former times only one sample-system or a random test from time to time was sufficient to ensure the product's quality, we nowadays see that the manufacturers and customers demand photometric tests on every single system produced.

While the measurements at the start of a development or the tests on the prototypes are not really critical in terms of time, they are now on production control applications. Sometimes only a few seconds are available for the complete test in order not to disturb the production

cycle of the product. Different measurement technologies must be used to perform the required measurements in a very short time frame. A quick and reliable documentation of the test conditions and results is needed to trace the reasons for any difficulties that may occur later in the product life.

To ensure the mass production quality, not only the complete product after production has to be tested. The unreliability of LED sources made the incoming goods inspection more important than it had been with classical light sources.

Dependant on the order volume LEDs can be bought from a number of LED bins; very seldom from sub-bins for much higher prices. The smaller the bin selection is the higher the costs for the LEDs are.

LEDs are typically binned in bins for their total luminous flux as well as for their spectral distribution. In most of the challenging LED projects nowadays it is indispensable to do a careful incoming goods inspection for the flux and spectral distribution or colour properties. For multi-LED systems it is very often necessary that the LEDs are sorted based on these tests and combined in a proper way during the assembly of the system. If the LEDs can be seen in very close neighbourhood in the final set-up, it is important to assemble only LEDs bearing the same properties together in one system to ensure colour and flux homogeneity. If the system uses the flux of all the LEDs inside to mix it and to illuminate something, LEDs from all the different categories are combined together to achieve the desired result.

Finally we have to consider another important fact with respect to the photometric performance of LEDs and the performance documented in their data sheets. In most of the LED based systems for illumination, signalling or sensing the LEDs are operated more or less continuously or continuously in PWM mode.

The manufacturer sorts the LEDs into their specific bins based on very short-time measurements far below one second operating time. These measurement values are transferred into the data sheets. Sometimes these photometric values gained in a very short operating time are just useless to rely on for the development process or for the product. User or LED customer performed measurements are once more indispensable.

## Appropriate Measurement Technologies

The major properties that are interesting from a photometric point of view are the total flux, the spatial luminous intensity distribution and the spectral distribution of the LEDs. As mentioned before, different approaches to measure these properties are needed or used during the development or during production control.

A reliable base for a professional development of an LED-based illumination system with optics simulation tools is a sophisticated near field ray set of the LED.

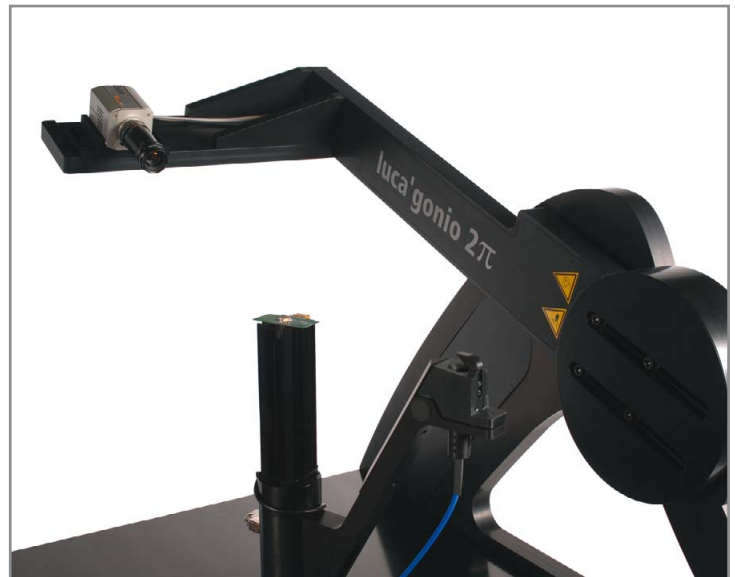

Figure 1: Near field source imaging goniometer.

Dependant on the tolerances acceptable maybe several LEDs of one type have to be measured to be able to perform an adequate tolerance analysis in the optics simulation later on. High-level ray sets of the LED sources are available for almost every optics simulation package in the world nowadays. The ray sets are derived from up to 10,000 luminance measurements taken automatically with a photometric measuring camera from all the different viewing directions around the source by using a near-field or source-imaging goniometer. To ensure a high ray set quality at the end the luminance measurements are taken with 12 to 18 bits and the setting of the camera's integration time is set to an optimum level for each single measurement. If necessary an LED cooling is done during the measurement to make sure that the LEDs operate in the same condition as in their later use. More and more multi-spectral measurements to gain multi-spectral ray-sets are performed.

However, the accurate measurement of all the luminance maps is only the start of the ray-set creation process. In a next step discrete rays are calculated based on the luminance measurements. A data reduction from approx. 40 GByte of luminance measurements down to approx. 600 MByte for a number of 20 million rays is done. However, the derivation of 50 or 100 million rays for very accurate optics simulations can be done easily with state-of-the-art computers.

LED systems are often very tiny systems. The LEDs are placed very close to secondary optics geometries or they even stick inside the optic, e.g. for a light pipe coupling optic. To make the ray sets useable for such applications it is inevitable to have all the rays starting from the boundary shape of the LEDs. Auxiliary ray starting geometries around the source like an imaginary sphere or a cylinder will fail.

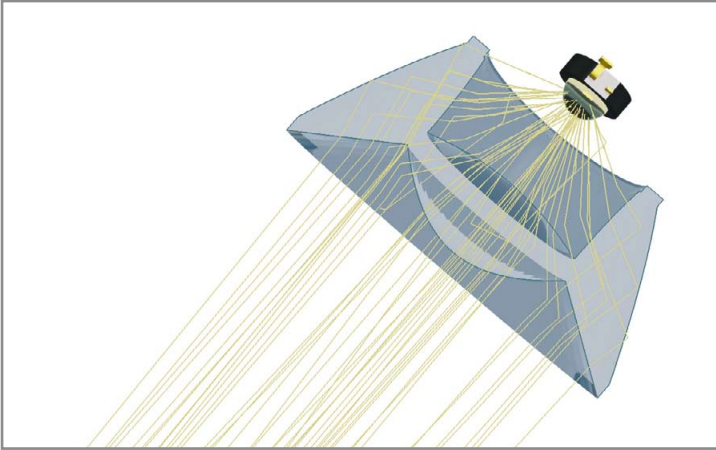

Figure 2: LED ray set model with secondary geometry.

Besides the near- and far-field luminous intensity distribution we have to focus on the total flux and colour issue also. For the total flux measurement integrating spheres or again goniometers are well suitable. If time doesn't matter, and typically time isn't the main issue while creating accurate data as a base for a professional optics development, the goniometer approach is the preferable way, since this approach suffers much less from spectral and spatial influences. To perform further measurements for example to obtain the temperature dependant change of the luminous flux, an integrating sphere or on-axis luminous intensity measurement can help to gain the required data in a reasonable time.

To qualify and quantify the spectral properties of the LEDs, state-of-the-art CCD-array based spectrometers are well qualified to do the job. Tristimulus weighted colour measurement devices are not able to deliver the information needed, since they can not deliver the spectral distribution of the LEDs. Details about peak wavelength or colour rendition indices can only be measured by using a spectrometer. The spectral resolution of the CCD-array spectrometers is good enough for the calculation of the colorimetric data needed. Due to their short measurement time they are also well suitable for a speedy incoming goods inspection of the LEDs.

Sometimes the application is critical against the spectral change of the LED's behaviour vs. the emission angle (e.g. for white coloured LEDs). In this case the CCD-array spectrometer can easily be mounted on the goniometer to collect this data.

This article focuses on source related measurements. At the end, however, the photometric performance of the LED based system is dependant not only on the source but also to a great extent on the material and surface properties of the system. The precise prediction of an optical system's behaviour is not possible without the knowledge of the surface and material parameters. The spectral information of the materials in reflection and transmission can be gathered again by using the described CCD-array spectrometers together with some add-ons. The BSDF (scatter information) of the surfaces is measured with a BSDF measurement goniometer. The basic goniometer can be the same as the one used for measuring the ray set information of the source. In the

need of high dynamic measurements a PMT detector is used instead of the CCD camera. For mainly specular surfaces quick and reliable camera based BSDF measurement methods are available without any need for moving parts. This method delivers the result in just a second with very high resolution close to the specular reflection. However, the total angular range of this method is rather limited.

Based on the described measurements on sources and materials a professional optics development can now be performed.

For the testing of the first prototypes to verify the development work the same measurement systems are used as for the measurement at the beginning of the project. Although time is always a matter very close to the start of mass production, there is still no real need to have a very fast method to measure. Besides the measurement of the pure photometric values the measurement of temperatures becomes more important because now the LEDs are mounted in their later environment and are driven with the planned current. Design changes due to temperature issues are necessary fairly often during this phase of the development process.

The main focus of the photometric measurements on the LEDs at the beginning of a project is total flux and luminous intensity, sometimes luminance and etendue issues also. Regarding the measurement of complete LED illumination systems the produced illuminance distribution or luminous intensity distribution is of great importance very often. Two main methods are available to measure and verify the illuminance distribution. The traditional way is to measure a grid of points on a far field photo-goniometer. Dependant on the time spent the measurement grid can be close-mesh or coarse-mesh. In any case the measurement is done on discrete points and the readings do not represent the complete illumination distribution densely. The measurement time is fairly long.

The second approach is camera related. The illumination system illuminates a screen and produces an illumination distribution on that screen. The measurement camera typically measures luminances. Due to the lambertian reflecting screen it is possible to do a calibration of the system from luminance to illuminance. Camera-based the system is now able to measure the illuminance distribution in less than a second with more than a million measurement points. The result is a picture of the illuminance distribution with all the measurement points lying densely. By knowledge of the geometry of the illumination system relative to the measurement screen, the system is able to calculate the luminous intensity distribution with the same density of values right away.

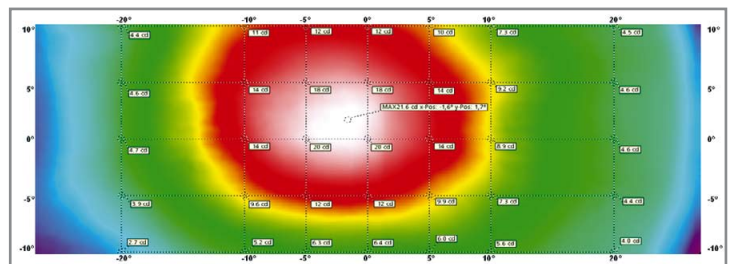

Figure 3: Camera based luminous intensity measurement of an automotive LED tail lamp.

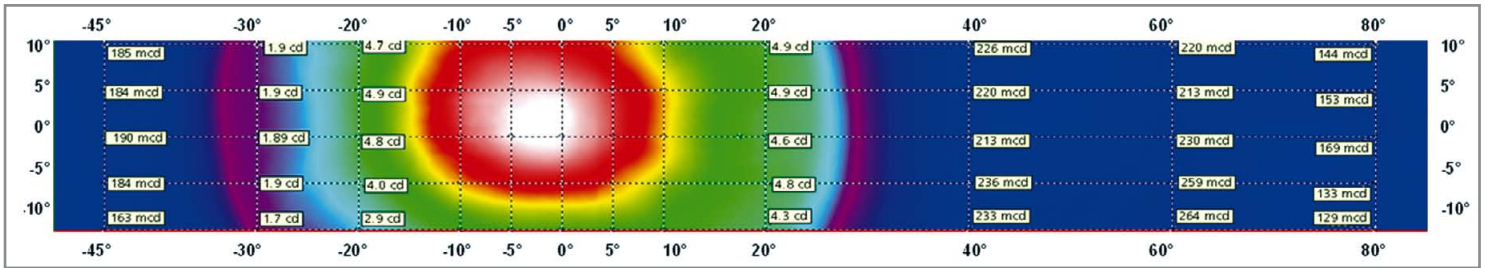

Figure 4: Wide angle measurement of an LED tail lamp.

The picture of the illuminance or luminous intensity distribution is of great value to receive quick and significant information of the distribution as well as to create professional measurement documentations. Even small dark- or hot-spots or little variations in the homogeneity of the distribution can be seen at once. A discrete point-based goniometer measurement is not able to deliver this information in a reasonable time.

Time is becoming more and more crucial for measurements in production environments. Long lasting goniometer measurements are no longer possible or only for sample parts from time to time. The trend in mass production during the last years is a demand in the photometric testing of 100% of the produced systems of the production line. In order to meet the production cycle requirements the measurements have to be done in a very short time, sometimes only a few seconds are available for the complete test.

The fast measuring systems like the described CCD array spectrometer and the CCD camera based measurement of luminances as well as illuminance or luminous intensity distributions are well approved to serve as fast measuring and reliable tools in production control.

In some signalling applications there is a need for the measurement of wide angle luminous intensity distributions. The camera approach combined with the screen would fail due to the limited size of the screen. In these cases the camera approach is combined with the goniometer principle again. The goniometer or turn unit is turning the signalling system to several but only a few different angular positions with respect to the screen. At each position the camera takes a high density measurement. When the measurement is finished the software combines all the measurements at the different emission angles to one final distribution. This enables a measurement of omni directional lights in only a few seconds.

In production control there is an even stronger demand for a quick and reliable documentation of the measurement results. With the described methods it is possible to produce a very quick measurement as well as a sophisticated documentation very easily.

## Conclusion

The described methods to produce precise measurement data for the design process of LED driven optics or illumination systems are well established in almost all industries dealing with light. Professional LED system developments are carried out based on high-level ray sets of the LEDs today.

Mass production testing of the photometric performance is becoming more and more standard in the markets. Examples of successful applications of the described technologies in serial testing are medical lighting, automotive lighting, aircraft cabin lighting, marine lighting or airfield lighting.

Almost every day new LEDs and new LED based systems are offered on the market.

Well approved and reliable testing devices and procedures help a lot to reduce the product to market period and to ensure a high quality of the LED based product in mass production. ■

## References:

- [1] „LED Technologie für die Allgemeinbeleuchtung“, TAE Esslingen, Germany, 2009 Steffen Block, OSRAM GmbH
- [2] „Lichtmesstechnik in der Beleuchtungsoptik“, Seminare Beleuchtungsoptik der PhotonicsBW, Weingarten, Germany, 2005, 2007, 2008, 2009, Juergen P. Weisshaar, opsira GmbH

# Imaging Colorimetry: LED Device, Luminaire and Display

> Hubert Kostal, Ph.D., Vice President of Sales and Marketing, Radiant Imaging, Inc., Christina Boehme, SphereOptics GmbH

With the excitement surrounding the emergence of LED lighting and displays because of LED lighting efficiency, environmental issues, and flexibility it is becoming increasingly important to be able to measure the performance of LEDs and LED-based systems in accurate and meaningful ways. This is even more important as LEDs are increasingly an alternative to more traditional technologies. The intended purpose of the measurement - to inform development, to characterize or evaluate finished products, for production quality control, or for in-use performance assessment - determines the photometric and colorimetric quantities that are important to measure. This, plus constraints on measurement time, accuracy, and cost, determine options for measurement methods. We survey a number of measurement methods that generate either near-field or far-field models of the LED or luminaire and evaluate their strengths and weaknesses to guide in selecting the right measurement method for the application. Of particular interest are not only the measurement of individual LEDs, but also the measurement of LED arrays and displays.

## Introduction

LEDs are an amazing technology - LED-based lighting and display systems are becoming increasingly popular due to their low cost, flexibility, and efficiency. Measuring the light and color output of LEDs and LED-based systems is therefore becoming more important as their performance is compared to and evaluated against traditional technologies. In addition, inherent performance variations from device to device must be understood and controlled.



Figure 1: Traditional light measurement with integrating spheres.

In measuring LED and LED-based systems, the selection of the measurement method and system will be a function of measurement objectives and, most likely, will be adapted to the specific nature of

LEDs. Measurement objectives span informing or assessing a LED or LED-based system design, characterizing a light source, evaluating the source for acceptance testing or quality control, or modifying and controlling performance.

Standards and recommendations on the measurement of LEDs are important guides for what measurement quantities are significant and how they might be measured. Especially when characterizing LEDs for use in lighting systems. For incoming or outgoing quality inspection, a set of indicator quantities will most likely suffice, simplifying the measurements needed. In all cases, it is important that the measurement relate to human perception of light and color.

When compared to other light sources, LEDs have several interesting characteristics. First, placement of the LED die in the package can significantly effect the direction that light is output in. Second, when LEDs are initially turned on they require some time - perhaps minutes - to stabilize. Third, they are inherently narrowband light sources so the creation of white light requires some form of color mixing. Fourth, the output of LEDs will vary, non-linearly, with current. And finally, LEDs become less efficient over time due to electron depletion, and so „age“ in use, diminishing in brightness over time. All of these factors should be taken into account when measuring LEDs.

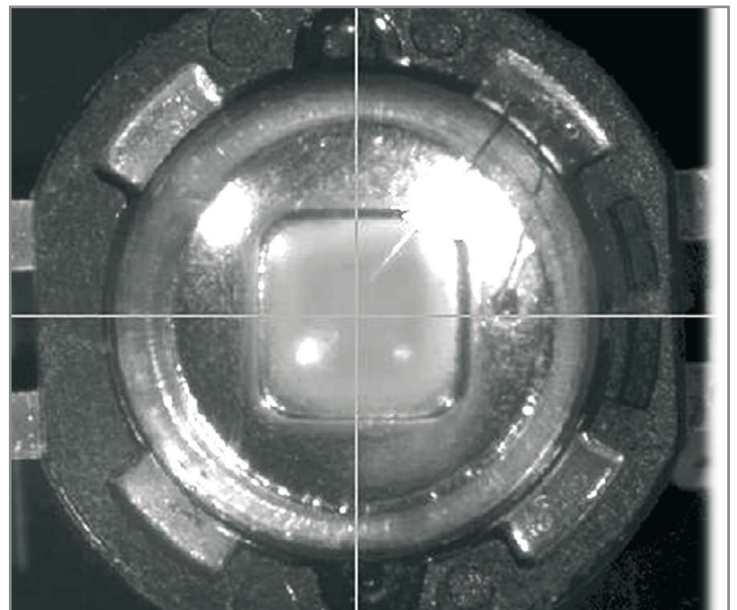

Figure 2: High resolution measurement of LED light and color output is needed for accurate optical design.

## Describing LED Brightness and Color

The performance of LEDs, and light sources in general, can be described in terms of the angular distribution of their output power as a function of wavelength. Direct description of output power as a function of wavelength is referred to as radiometric. To describe brightness and color as perceived by the human eye, this spectral power distribution is weighted according to how the human eye perceives different wavelengths and integrated to provide a photometric (brightness as perceived by the human eye) or colorimetric (perceived color) description.

## LED Brightness

Brightness is measured as luminous intensity, which is the weighted (according to human perception) power emitted by a light source in a given direction per unit solid angle. Luminous intensity is described in units of candela (cd). A related quantity is luminance, which is the luminous intensity per unit area emitted in a particular direction. The units of luminance are candela per square meter ( $\text{cd}/\text{m}^2$ ); this is often referred to as a „nit“.

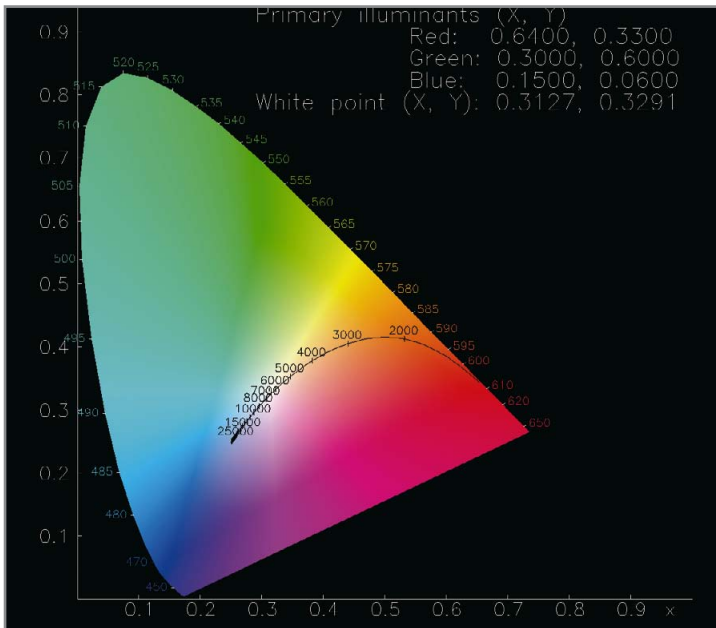

Figure 3: CIE color chart 1931.

## LED Color

The color of a source, again in a particular direction, is described in terms of a color space, the most common of which is the CIE 1931 color space. Here color is defined in terms of XYZ coordinates - or tristimulus values, X, Y, and Z - where the Y coordinate is brightness of the source and the chromaticity parameters are derived from X, Y, and Z.

Two other quantities describing the color of a source that are often useful. First, it's Correlated Color Temperature (CCT) which is technically the color temperature of a black body radiator that most closely matches the source. CCT is measured in Kelvin (K). Less technically, higher CCT ( $>5000^\circ\text{K}$ ) are "cooler" (more bluish) and lower CCT ( $<3000^\circ\text{K}$ ) are "warmer" (more yellowish). Second, the color-rendering index (CRI) of a light source is a measure of the accuracy of the color appearance of illuminated objects when compared to illumination by natural (ideal) light. CRI can be derived from the spectral measurements of a light source. Unfortunately, CRI as a descriptive quantity is problematic. It provides indicative information, but is known to be inaccurate in some cases; newer approaches to defining CRI are being actively researched.

For a complete description of an LED, LED lighting or display system, these radiometric, photometric, or colorimetric quantities need to be described as a function of angle relative to the source.

## Measurement Considerations

This creates three interesting measurement considerations: First, why measure at all; second, what angular granularity is required; and third, is the source measured as a point source or an extended source? The question of why to measure at all is more than a philosophical question. If the measurements are being done to characterize a source for modeling purposes, it can be argued that a theoretical model will suffice. In general though, the potential complexity of a light source as a system and the potential for error in theoretical understanding are sufficient to make a measurement preferred, as it is a real description of the source. Of course for evaluation, inspection, or control, having the real data specific to a device is necessary as the measurement is the point.

For some applications a point measurement from one viewing angle or a single integrated measurement will suffice. But for most applications, the variation of luminance and color with angle is an important attribute of the device, especially for LEDs given manufacturing variations on where the die is placed in the package - a slight variation can result in significant change in the distribution. There are two kinds of angular measurements: those in which all the desired output light is captured and measured, and those where the angular data is sampled on a grid. In the latter case, the spacing between angular measurements can be determined based on the anticipated continuity and rate of change of distribution. Usually good enough estimates of this can be made to define a measurement series or method that will produce good data.

## Near and Far Field Measurements

For some applications (such as evaluating the brightness of an LED indicator light), the source can be treated as a point source. For other applications, such as characterizing an LED or LED luminaire for optical design, the source should be treated as an extended source - meaning one that has physical extent and so has spatial variation in light output from point to point on the source. In this case, the source needs to be measured in a way that yields this more detailed distribution. Measuring the light as a point source yields a far-field measurement. Measuring the light source as an extended source yields a near-field model of the source.

In application the near-field model is expressed for optical design purposes as a ray set. The quality and usefulness of the ray set will be a function of both the number of rays in the set and how the rays are statistically sampled based on the near-field measurements of the source. Common statistical sampling methods range from simple Monte Carlo sampling to importance sampling. Importance sampling weights rays according to the brightness of the point on the source where they are emitted rather than just selecting starting points with equal weighting.

A near-field model can be extrapolated to a far-field model, but the reverse is not true. This is because the far-field model is a limiting case of the near-field model with a collapsed light source. A rule of thumb for the boundary between the near and far-field regions for optical

devices is about 10X the largest dimension of the source. So for an LED, this would be a few cm, but for a luminaire this might be tens of meters. Beyond the range the far-field model and the near-field model will give essentially the same results.

## Imaging Colorimetry as Applied to LEDs

A fourth measurement issue to consider is the need for spatial data as opposed to a single point or spot measurement. Spot colorimeters or spectroradiometers only measure a spot on or around the source - the "spot" is actually integration over some regular area. This may provide some useful information; it is not very efficient for measuring sources or displays when spatial information is required.

Imaging colorimeters - calibrated CCD-based cameras with CIE match photopic and color filters - overcome these issues, providing the equivalent of millions of simultaneous spotmeter readings on a spatial grid. A typical imaging colorimeter consists of a full-frame or interline CCD, photopic or colorimetric filters, and lenses. The choice of CCD will depend on the application, with the full-frame CCD preferred when there is to be no gap in the image capture and when higher dynamic range is required. The CCD may be cooled and temperature controlled to reduce noise levels. Careful electronic design and regulation of readout speed will also reduce system noise. The photopic or colorimetric filters are preferably specially designed to allow the system to match the CIE color curves for Red, Green, and Blue. The overall system, with the lens included, is usually extensively calibrated to remove the effects of any optical aberrations or CCD variations.

While not all of the measurements methods applied to LEDs and LED-based systems require the use of an imaging colorimeter, these measurements can often be made more extensively or faster by using one to capture multiple arrayed measurements simultaneously. This is particularly important when measuring an extended light source, an array of LEDs, or an LED display. In each of these cases the spatial relationships are a key component of the data required to describe and understand the system.

An imaging colorimeter that only measures photopic information is referred to as an imaging photometer. For easy of description of the various measurement methods we will refer to imaging colorimeters, but an imaging photometer could also be used, with obvious limitations.

## Measuring LED Devices

Measuring LED die or packaged LEDs is usually done in R&D to assess different design options or to exhaustively characterize the performance.

### With Source imaging goniometers

Source imaging goniometers (see Figure 4) are designed to very accurately measure the near-field luminance distribution of a light source. While there are a number of physical configurations possible, they all virtually move the imaging colorimeter around the light source and capture the output light distribution at the source from multiple - usually thousands - viewing angles. This information can be stored as

raw data or converted to ray sets on the fly. Either data representation is considered a near-field model.

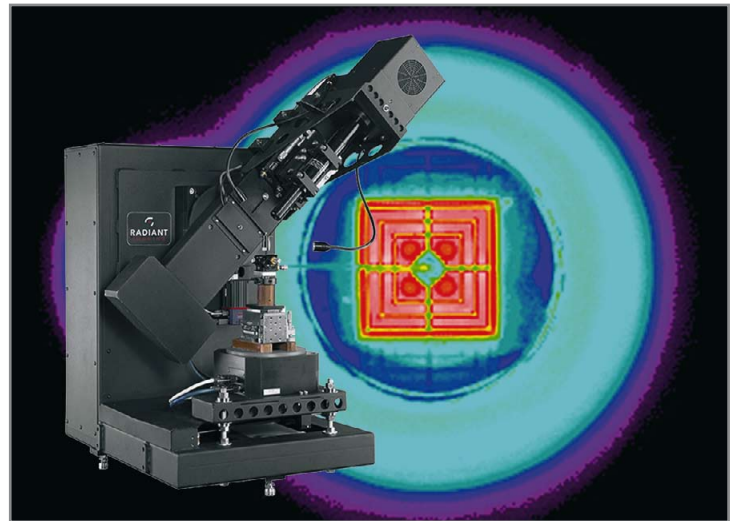

Figure 4: With two independent axes of rotation a source imaging maintains precise positioning between the DUT (device under test) and the imaging colorimeter.

Critical attributes describing the physical accuracy of the source imaging goniometer are captured in a parameter known as "wobble" - this is the maximum excursion of the focal point of the system from its origin as the system is moved to various measuring positions. For measuring an LED die, which can be about 0.5mm across, this wobble should be no more than a few tens of microns (i.e., only a few per cent of the dimension of the die). Similar accuracy requirements hold when measuring packaged LEDs and any other light source.

Another critical attribute is quality of the optical system used. The system should have a small enough field of view sufficient CCD pixels map to the surface of the light source to see any relevant fine scale detail on the LED die or device.

Source Imaging Goniometer near-field models are the most comprehensive representation the luminance and color output of LED die and devices as a function of angle. These measurements, since a scan consists of thousands of images, generally require several hours to complete for a single source. Faster measurement times are possible by compromising on angular resolution, imaging optics, or the allowed error, but this is really unacceptable for LED die and device characterization. Recent advances in Source Imaging Goniometer incorporate the simultaneous acquisition of spectral data.

### With integrating spheres

Integrating spheres provide a means of measuring total or integrated light output of an LED. Depending on the sensors used, radiometric, spectral, photometric, or colorimetric measurements can be obtained. An integrating sphere commonly does not capture angular information relative to any of these quantities. An integrating sphere operates quite simply by putting the LED into the sphere, reflecting the light around off of the sphere, and measuring the integrated light at a port on the sphere.



Integrating sphere measurements have the advantage of being very fast, and it is simple to change sensors to obtain radiometric, spectral, or colorimetric measurements. These measurements can be used to evaluate or bin LEDs. The major limitation is that no angular information is obtained, so LED packages with misaligned die (resulting in a skewed directional output of light from the LED) would not be detected.



Figure 5: High Power LEDs measured with two Integrating Spheres.

#### With imaging spheres

The Imaging Sphere is a logical combination of the concept of an integrating sphere with an imaging colorimeter. In an imaging sphere the light source is placed at the center of a hemisphere where the inner surface is partially reflective. An imaging colorimeter is then used to capture the light projected onto the surface of the hemisphere in a single measurement. The result is a far-field luminous intensity distribution covers  $2\pi$  steradians. The approximate angular resolution captured is as little as  $0.25^\circ$  and with a full-frame CCD there are no gaps between the measured points. The imaging sphere dome can be varied in size, with two common sizes being 250mm and 100mm radius; the later corresponds to a CIE Condition B measurement.

The advantage of the imaging sphere is the high volume of angular data gathered in a matter of seconds. The imaging sphere can therefore be used to characterize the angular output of an LED for general evaluation. The main disadvantage of the imaging sphere is that no spectral data is captured simultaneously and that the maximum source size is limited by the sphere size.

#### With a photogoniometer

A photogoniometer measures the far-field distribution of an LED by using a goniometer to move a colorimeter (or spectroradiometer) relative to the LED device. This has the advantage of allowing multiple measurement devices to be employed to vary the information obtained from the scan. The disadvantage of the photogoniometer is the length of time required to make the measurement and the complexity of achieving the required mechanical accuracy.

## Measuring LED Luminaires

There are several applications that require the measurement of LED luminaires: optical design requiring near-field models of LED lamps, quality control, and illumination measurement. The most significant challenge in measuring luminaires is to have sufficient space to measure large sources.

#### With a near-field imaging goniometer

Near-field imaging goniometers are designed to measure large light sources. When compared to source imaging goniometers, there is generally some design concession made to enable large source to be manipulated in the view of the imaging colorimeter. A typical configuration, shown in Figure 6, consists of a two-axis goniometer and an imaging colorimeter. The light source is rotated through an automated measurement sequence in the view of the imaging colorimeter and the associated software constructs a near-field model of the source. This system allows the spectrum of the LED luminaire to be measured simultaneously, and so a spectral distribution as a function of viewing angle can be produced as well.

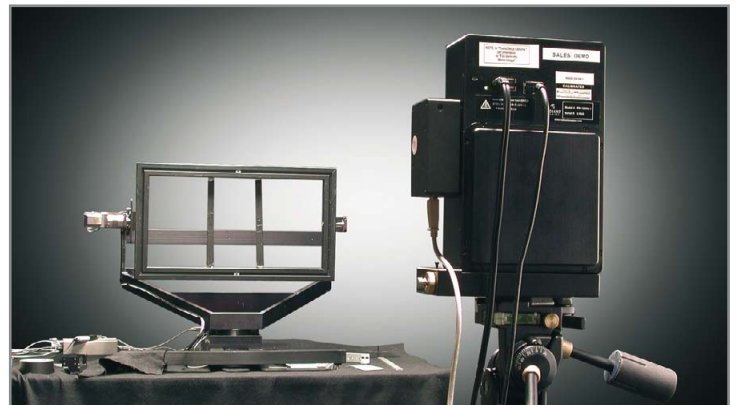

Figure 6: Measurement of large LED luminaires. By directly measuring large light sources from within the near-field, a combination of a two-axis goniometer and imaging colorimeter can obtain detailed performance measurement in a compact laboratory space.

Since the imaging colorimeter is able to measure the LED luminaire from within the near field of the light source, this method allows measurement in a very compact laboratory set-up. The resultant near-field model can be used for optical design using the LED luminaire. The model can also be extrapolated out to give an illumination distribution at any distance, on any surface. The main limitation of this measurement approach is the time that a scan takes, which can be several hours depending on the angular step size desired.

#### With a photogoniometer

A photogoniometer – generally larger than the type used to measure individual LEDs – can be used to measure LED luminaires. For the measurement to be accurate, the sensor must be in the far field relative to the light source, so either the system needs to be fairly large, so requiring a large lab, or a system of mirrors is required to fold the optical path. Again, the flexibility of using interchangeable sensors is positive, but a full measurement sequence does require an extended period of time as well as sufficient lab space.

## With an imaging colorimeter

An imaging colorimeter can be used to directly measure the illumination distribution of an LED luminaire. To do this, the light from the luminaire is projected on a surface (whose optical response has been baselined) and the imaging colorimeter is used to image the beam pattern on the surface. The result is an illumination distribution. This measurement is very fast – just a few seconds of imaging time – but requires sufficient space to set up as the distance from the LED luminaire to the surface (usually a wall) should be enough for a far field measurement. Because of the speed of measurement, this method is generally best for quality control if the full illumination distribution is desired for making pass/fail decisions.

## Measuring LED Arrays and Displays

LED arrays, which may be related as in LED clusters forming together a lamp or unrelated as in a grouping of indicator lights, can often be measured simultaneously to increase measurement efficiency and overall speed. These arrays can consist of a few LEDs together in the simplest case up to literally millions of LEDs in a high resolution LED video screen. The measurement of the array is made from one particular viewing angle – usually a direct view normal to the array – and luminance and color are measured for each individual LED. This provides comparison between LEDs under the same conditions and allows relevant spatial relationships – such as uniformity of luminance and color across an LED display – to be analyzed.

Once the relationship between LEDs has been measured this data can be used for characterization or evaluation or, in some interesting applications, for control. Because the luminance of LEDs can be adjusted using current or PWM (pulse width modulation) control, this admits the possibility of changing the performance of the LED array by making adjustments in the power to each individual LED. This measurement information can be used to balance output.

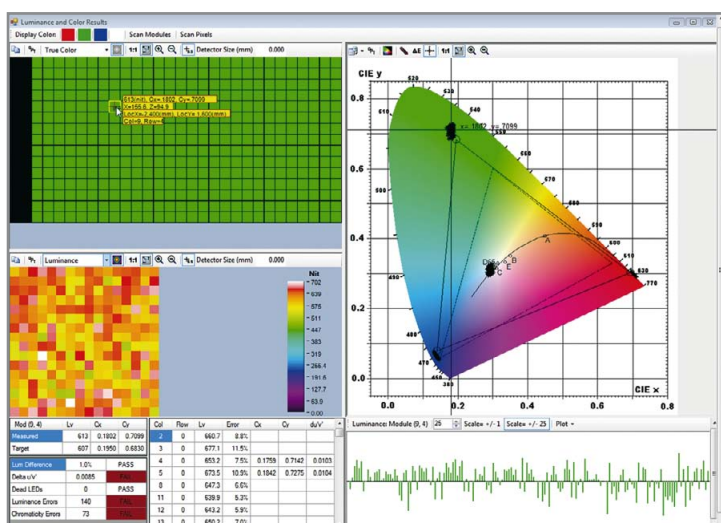

Figure 7: LED screen performance measurement. Using an imaging colorimeter allows the simultaneous measurement of the light and color output of 10's of thousands of LEDs and their spatial relationships. Application software allows their complex relationships to be readily analyzed.

For LED displays, this spatial information is critical as performance variations between LEDs and so LED pixels results in aberrations in the displayed image. A display – whether showing still images or video – has to be uniform in color and brightness, and has to match a prescribed color gamut. Indeed, the basic performance parameters that apply to any display technology apply to an LED display. There are several ways that LED displays are special however: first, the performance of individual pixels can be controlled (with appropriate electronic design); and, second, the displays are modular, making differences between modules very noticeable. Therefore the same imaging colorimeter measurements that capture the performance of the screen can also be used to prescribe how to correct the screen.

## With an imaging colorimeter

An imaging colorimeter is ideally suited for measuring LED arrays and LED (and other) displays as the measurements are taken on a spatial grid that generally matches the way that images and information are presented on a display. The image captured with the imaging colorimeter can be automatically segmented into regions of interest that capture the performance of individual LEDs or LED pixels or LED modules, and so provide performance information on local and global uniformity. For LED displays this data can be used to calculate pixel and module level correction coefficients to optimize luminance and color uniformity and to match a target color gamut. Imaging colorimeters have been used to measure and correct LED displays both in manufacturing and in field installations.

## Conclusions

Because of the breadth of applications that exist for LEDs as indicator lights, in backlights, in luminaires, and displays, there is a comparable breadth of radiometric, photopic and colorimetric measurement methods. These methods trade-off measurement time, resolution, information content, and logistics to address the needs of R&D, manufacturing, and field applications.

The most important choices to make in measuring LEDs or LED-based systems are: is near-field or far-field data needed? Is angular data needed? Is an array measurement required? The answers to these questions will indicate the measurement options. In many cases the use of an imaging colorimeter is optimal because it can capture a large number of simultaneous, spatially related, measurements. It is also flexible enough to be coupled with goniometric systems or other optics (e.g., the imaging sphere) to measure light and color distributions quickly and with high granularity.

As advances are being made in the design and application of LEDs and LED-based systems, so too, are advances being made in how imaging colorimeters can be used to measure them (e.g., by integrating spectral measurements) and improve their performance (e.g., through the correction of LED video displays). ■

# LED LIGHTING Taiwan 2010

## LED照明展 LED Lighting Taiwan

The 6th Int'l LED Lighting Exposition  
<http://www.optotaiwan.com>

**June 9-11, 2010**

Taipei World Trade Center



### Exhibits

- **LED Lighting Fixture**  
for Indoor, Outdoor, Specialty, Solar  
for Decorating, Landscape, Architecture, Garden  
Control System & Accessories
- **LED Applications**  
Automotive Lamps, Backlight,  
Display Board, Traffic Signal, IrDA, etc.
- **Package / Module**  
Lamp, Digital, Dot Matrix, Cluster, SMD, etc.
- **Epi Wafer, Chip**
- **Materials**  
Substrate, Ingot, Phosphor, Epoxy,  
Lead Frame, etc.
- **Processing Equipment**  
Wafer ( MOCVD, Mask, Etching )  
Assembly ( Dicing, Bonding, Packaging )  
Testing ( Prober, Aging )

### Organizer



#### Photonics Industry & Technology Development Association

5F, No.9, Roosevelt Road, Sec.2, Taipei 10093, Taiwan

<http://www.pida.org.tw>

Tel : +886-2-2351-4026 Fax : +886-2-2396-8513

【 Overseas contact 】 Pamela Hsiao (ext. 805) , Allen Lee (ext. 850) E-mail : [exhibit@mail.pida.org.tw](mailto:exhibit@mail.pida.org.tw)

【 台灣地區 】 張雪卿 小姐 (ext. 809) E-mail : [cathy@mail.pida.org.tw](mailto:cathy@mail.pida.org.tw)

## Thermal Management

# When Designing with Power LEDs, Consider Their Real Thermal Resistance

> Dr. András Poppe, Marketing Manager, MicReD Division, Mentor Graphics Corp.

It is a well-known fact that the light output characteristics of light emitting diodes (LEDs) depend heavily on the operating conditions. The forward current applied to the LED is the primary variable—the higher the supplied current, the more light that is generated by the device. Unfortunately, when an LED is driven by a constant current source, the light output drops when the LED's temperature increases. This common feature of all LEDs is best illustrated by the dependence of their light output spectra as shown in Figure 1. In addition to the efficiency loss, the color of the LEDs' light also changes as proven here by the shift in the peak wavelength.

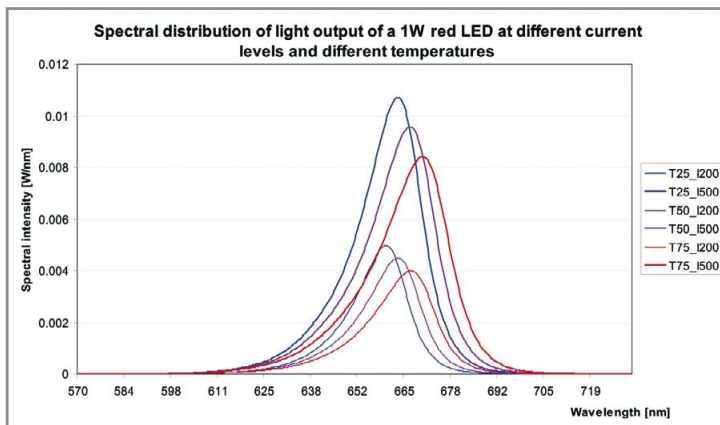

Figure 1: Current and temperature dependence of the spectral distribution of the light output of a red LED.

## The Importance of LED Thermal Properties

Since light output characteristics change with temperature, proper thermal management is a key issue in power LED-based lighting applications. By keeping LEDs cool, high efficiency can be maintained. A thermal management solution that delivers better cooling also delivers more useful lumens in a given application.

This means that the real junction-to-ambient thermal resistance of the LEDs in their application environment is key factor in lighting design. Unfortunately different LED vendors report their products' thermal resistance and other temperature-related characteristics in diverse ways. Therefore standardization activities related to thermal issues of power LEDs were started in various thermal standardization bodies. A new standard for the proper measurement of LEDs' thermal resistance

is currently being drafted by the JEDEC JC15 committee [1], [2]. In addition, the International Lighting Committee (CIE) set up new technical committees (TC-2-63 and TC-2-64) to deal with the thermal aspects of LEDs. Among these committees an agreement is emerging that vendors need to consider the actual  $P_{opt}$  emitted optical power (that is, the radiant flux denoted as  $\Phi_e$ ) of the LEDs when calculating thermal resistance per the following formula:

$$R_{th\_real} = \Delta T_j / (I_F \times V_F - P_{opt}) \quad (1)$$

Here the product of the LED's forward current and forward voltage ( $I_F \times V_F$ ) represents the electrical power supplied to the LED and  $\Delta T_j$  denotes the change the LED chip's operating temperature (the change of the junction temperature).

Neglecting the optical power when determining an LED's thermal resistance yields resistance values much lower than reality. If lighting designers use these numbers to calculate the expected light output of their LED-based lighting applications, the design will very likely fail to meet its light output specs. The real thermal resistance is higher, and therefore the junction temperatures will also be higher. As a result the actual luminous flux obtained from the luminaire will be below the required level. Clearly the real thermal data of the LEDs is essential to a successful LED design project.

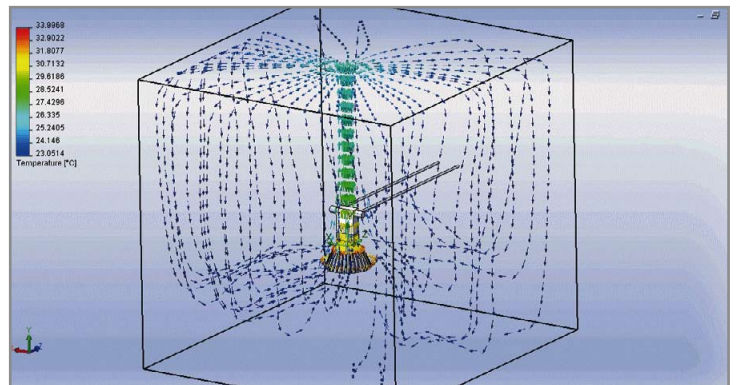

Figure 2: CFD simulation results of an MR16 retrofit LED lamp application obtained by the Mentor Graphics® FloEFD™ analysis tool which can be used within an MCAD environment.

## Thermal Characterization: Simulation and Physical Tests

Thermal simulation can help the designers understand the cooling properties of their LED lighting solutions. Since the heat from the LED luminaire is usually dissipated into the ambient environment by natural convection, a CFD analysis tool is needed to determine which design provides the best thermal performance.

Figure 2 shows the simulation results for a retrofit MR16 LED lamp application in a JEDEC-standard natural convection test environment.

To set up a flow simulation model properly, the thermal resistance of the LED must be determined by real physical measurements. These measurements are typically performed by thermal testers such as, e.g.

the T3Ster® system, a product within the MicReD® series from Mentor Graphics. Figure 3 shows the physical test setup of the LED lamp application depicted in Figure 2.



Figure 3: The T3Ster thermal tester was used to physically test the MR16 retrofit LED lamp application.

The junction temperature transients known as Zth curves shown in Figure 4 were measured by the T3Ster thermal transient tester. The results can be used to obtain structural details of the heat conduction path of LED devices, from the actual PN junction of the LED toward the luminaire and beyond to the ambient. These properties are represented by means of a thermal capacitance / thermal resistance map. Such maps are called structure functions. Structure functions help designers locate the discrete sections of the complete cooling solution starting with the LED chip, through the applied thermal interface materials, and ending at the heat sink or the LED luminaire itself.

As Figure 5 illustrates, about 50% of the total junction-to-ambient thermal resistance of the entire lighting application is represented by the LED itself. Structure functions provide help not only in structural analysis (such as die attach failure detection), but also in generating dynamic compact thermal models of power device packages. The resulting models are directly usable in CFD tools. (At this writing, some semiconductor vendors have begun to use transient models to report the thermal performance of their packaging solutions.)

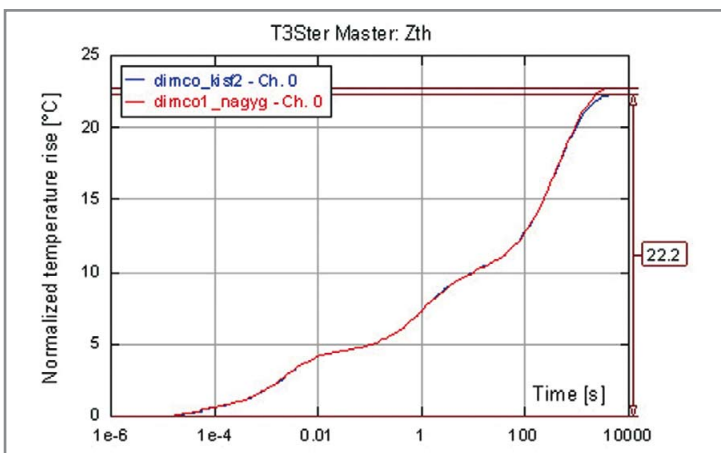

Figure 4: Thermal impedance diagrams of the MR16 retrofit LED lamp measured in a standard natural convection test environment using two different sockets.

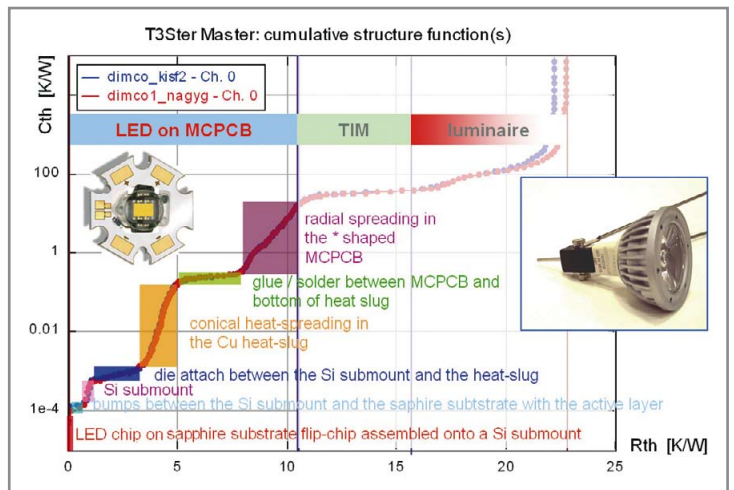

Figure 5: Contributions of different sections of the junction-to-ambient heat-flow path to the total thermal resistance and thermal capacitance of the MR16 retrofit LED lamp application shown by the structure function calculated in the T3Ster-Master™ tool.

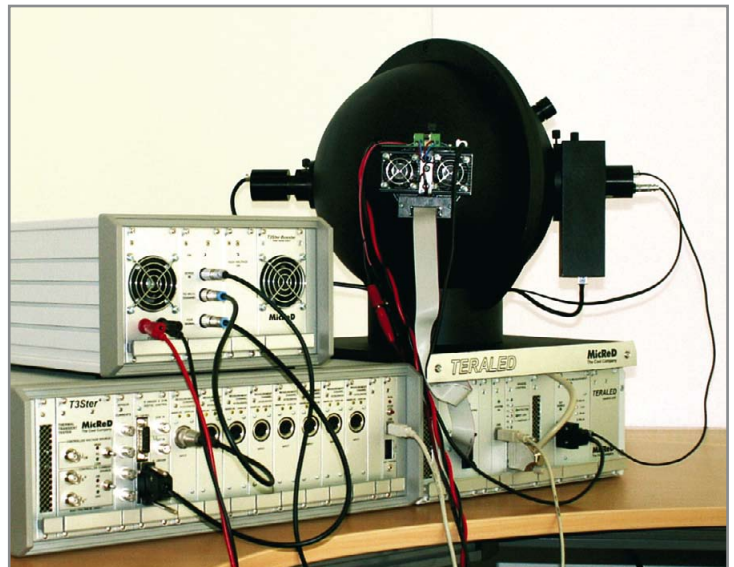

Figure 6: Combined test setup for an automated measurement of the thermal and photometric properties of power LEDs.

## Combined Thermal and Photometric Characterization

Figure 4 and 5 presented some useful comparative results for the sake of explanation, but for actual design work real thermal data is needed. So exact knowledge of the emitted optical power of the LED under test is essential when calculating the actual thermal resistance.

To acquire this information, a thermal test setup (complying with the applicable thermal measurement standards [3]) must be paired with a test setup that can measure the light output of LEDs. The latter tool must of course meet the relevant CIE recommendations [4]. Figure 6 depicts an example of such a combined system. The T3Ster thermal tester provides electrical power to the LED being tested (device under test, or DUT) within the TERALED® system, an automated photometric test setup consisting of an integrating sphere with a temperature-

controlled DUT holder and a detector with a range of filters. Control electronics and measurement software complete the system. The LED booster (the small box in the left of Figure 6) allows measurement of high forward voltage ( $V_f > 10V$ ) multi-chip LEDs.

Using this powerful pairing of tools, LED thermal resistance can be measured together along with light output characteristics including radiant flux, luminous flux, scotopic flux, and chromaticity values. These values can be measured consistently at various reference temperatures and forward current levels.

Adding the thermal transient measurement to the usual photometric measurements does not increase test time overhead significantly. Today's power LEDs, when attached to a cold plate (such as the DUT holder in the TERALED system), typically achieve a steady-state junction temperature value within 30 to 60 seconds. This is exactly the same time needed to measure the LEDs' thermal resistance when they are switched off after their light output properties have been measured.

## Effect of Reference Temperatures

Unfortunately the total junction-to-ambient thermal resistance of a complete thermal management solution might depend on the temperature of the environment. This means that when predicting thermal performance, the temperature of the test environment (also known as the reference temperature) needs to be reported. If combined thermal and photometric/radiometric measurements are performed the reference temperature is the cold-plate temperature.

LEDs' data sheets typically express data measured at 25°C while in environments where LED luminaires are being used, the temperature of the environment is typically much higher: about 50°C or even ~80°C. This results in junction temperatures ranging from 80°C to 110°C. These elevated operating temperatures can cause a significant drop in luminous flux.

In Figure 7 the Luminous Flux vs. Reference Temperature diagrams of the Cree MCE series of white LEDs is shown, measured for two different thermal management solutions. The samples were prepared with two different printed circuit boards (PCBs), one metal core and one FR4-based. In addition, different thermal interface (TIM) materials were used between the PCB and the heat-sink. As the heat-sink temperature (the DUT holder of the TERALED system) was increased, light output dropped.

Since the same type of LEDs were used in both samples, one would expect the two curves to run parallel, however this was not the case. The explanation here is that the total junction-to-ambient thermal resistance of the samples also varied as the reference temperature was increased. Structure functions presented in Figure 8 help identify which elements of the heat-flow path show temperature dependence. The first ~1.5 K/W section of the thermal resistance corresponds to heat-conduction inside the LED package. The subsequent section corresponds to the PCB and the thermal interface material between the LED package and the PCB. The last section corresponds to the TIM (thermal grease) used between the PCB and the heat sink. In the TG2500 sample, both TIM layers show

temperature dependence, resulting in a ~20% variance of the overall junction-to-ambient thermal resistance. The structure functions shown in Figure 8 are scaled to the real thermal resistance, that is, the emitted optical power measured by the TERALED system was subtracted from the electrical power measured by the thermal tester.

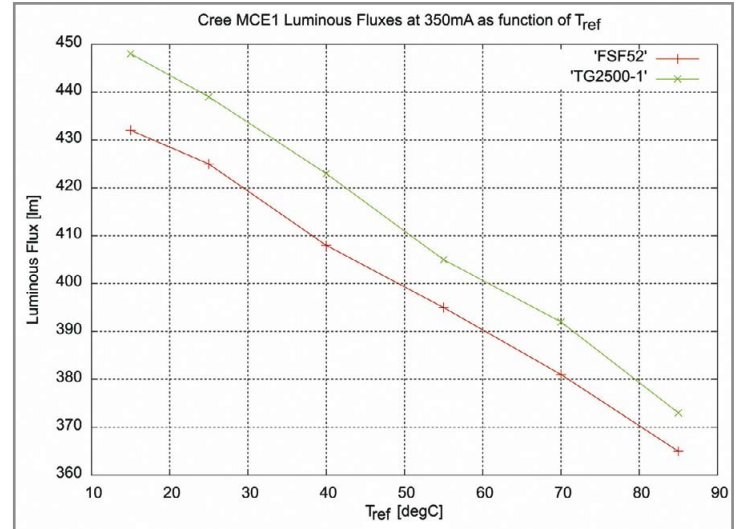

Figure 7: Measured Luminous Flux vs. Reference Temperature plots of 6W white LEDs, using two different thermal management solutions.

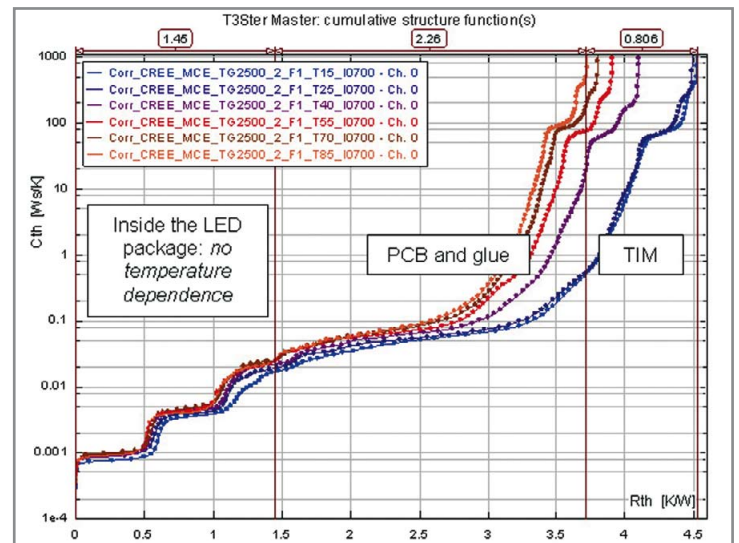

Figure 8: Structure functions of a 6W LED for different reference temperatures between 15°C and 85°C.

## Light Output as a Function of the Real Junction Temperature

Once the exact heating power and the exact thermal resistance value for every reference temperature value is known, with the formula below it is possible to calculate the exact junction temperature value of the LED under test:

$$T_j = T_{ref} + R_{thJA}(T_{ref}) \times P_{heat}(T_{ref}) \quad (2)$$

where  $P_{\text{heat}} = I_F \times V_F(T_{\text{ref}}) - P_{\text{opt}}(T_{\text{ref}})$  as used in equation (1) and  $R_{\text{thJA}}$  is the measured thermal resistance. If the measured data points shown in Figure 7 are re-plotted as functions of the calculated LED junction temperature, the effect of temperature dependence in the thermal resistance is eliminated and the luminous flux vs. (junction) temperature functions obtained for the two LED samples overlap (Figure 9). This perfect overlap of the two luminous flux vs. junction temperature diagrams indicates that in the case of our two samples, the LED chips and their packages were very much the same in terms of their light output characteristics.

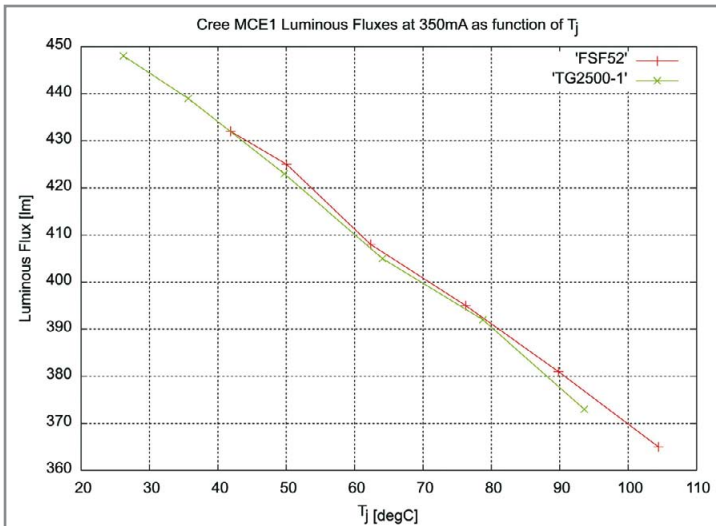



Figure 9: Measured luminous flux vs. junction temperature plots of 6W white LEDs, using two different thermal management solutions.

## Conclusion

Temperature is a key factor in the operation of LED-based lighting applications, not only in terms of life expectancy but also in terms of performance. Lower operating temperatures ensure more light output. Despite thermal standardization activities, today's LED data sheets still do not provide the real thermal resistance values of LEDs since most LED vendors do not yet combine thermal tests with the measurement of the light output characteristics (radiant flux, luminous flux). As a result they report thermal resistance values that are lower than the actual values. To allow effective prediction of overall thermal performance of LED based lighting systems using methods such as CFD simulation, one has to know the real thermal resistance of an LED package. If this information is not available, precise thermal transient testing combined with measurement of the emitted optical power and a subsequent analysis of the resulting structure functions may suffice.

As for light output characteristics, relevant temperature scaling details rarely appear in LED data sheets. By determining the thermal resistance of the LED and the heating power of the LED under test, light output characteristics can be presented as functions of the real junction temperature. This allows variations in the actual thermal resistance in the test environment (such as shrinking TIM resistance with increasing temperature) to be eliminated from the test results. When light output characteristics are scaled to the actual LED junction temperatures it is possible to make an accurate comparison among diverse LED devices. ■



# Gigahertz-Optik

## Measurement *of* Light Measurement *with* Light

### BTS256-LED Tester

Light Analyzer for Luminous Flux & Illuminance, Spectral Distribution & Color of Single LEDs, LED Modules, LED Luminaires and other Light Sources



**Gigahertz-Optik GmbH**  
D-82170 Puchheim Germany - Postfach 1445 • Tel: +49 (0) 89 / 890159-0  
Fax: +49 (0) 89 / 890159-50 • info@gigahertz-optik.de • www.gigahertz-optik.com

#### Acknowledgement:

Some of the test results reported in this paper were measured with the support of the KOZLED TECH\_08-A4/2-2008-0168 project of the Hungarian National Research and Technology Office and are reproduced here by courtesy of the Budapest University of Technology and Economics, Department of Electron Devices.

#### References:

- [1] Clemens J M Lasance and András Poppe, "LED Thermal Standardization: A Hot Topic", *Electronics Cooling Magazine* 15:(2) pp. 24-28. (2009) [http://electronics-cooling.com/html/2009\\_may\\_a3.php](http://electronics-cooling.com/html/2009_may_a3.php)
- [2] András Poppe and Clemens J M Lasance: „On the Standardization of Thermal Characterization of LEDs”, In: *Proceedings of the 25th IEEE Semiconductor Thermal Measurement and Management Symposium (SEMI-THERM'09)*. San Jose, USA, 15/Mar/2009–19/Mar/2009, pp. 151-158. Reprinted also in the June 2009 issue of *LED Professional Review*.
- [3] JEDEC JESD51-1 standard: [www.jedec.org/download/search/jesd51-1.pdf](http://www.jedec.org/download/search/jesd51-1.pdf)
- [4] CIE Technical Report 127:2007 „Measurement of LEDs”, ISBN 978 3 9 01 906 58 9

# Silicones in LEDs for Heat Dissipation and Improved Light Output

> Chris Dawson, Marketing Manager, ACC Silicones

Two critical pathways exist in any LED packages which are essential for maximum performance and optimal longevity. Both light and heat must have a direct pathway out and away from the LED; silicone can help improve these channels, thereby increasing performance and product life.

## The Challenges

### Maximise light output

The light produced by the diode has to pass through a number of different mediums or materials. Each material will have a different Refractive Index (RI). The RI is a measure of the degree that the speed of light changes as it passes between two materials. For example a vacuum has an RI of 1 and soda glass has a refractive index of 1.5 meaning that the light travels 2/3 (RI of a vacuum / RI of Soda Glass) of the speed it would in a vacuum. As light travels through two materials of different RI's the light is bent and some reflection takes place (see Figure 1). This reduces the amount of light being emitted from the diode. By using materials of similar RI values overall light output and efficiency can be increased.

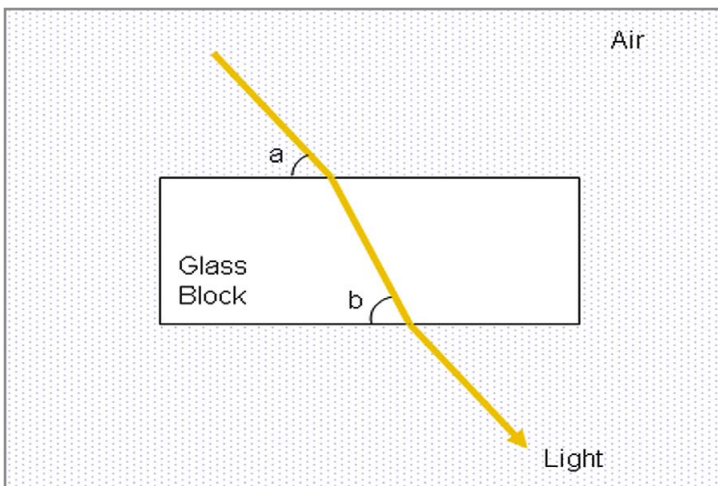

Figure 1: Light passing between two materials of different RI

### Using silicones to match RI values

Within LED production whether at the Micro or Macro level, silicones can be used to reduce or eliminate the detrimental effects of changes in RI values. Figure 2 shows a typical cross section of a HB LED. Optically clear silicone gel is injected between the lens and the diode to remove the air gap.

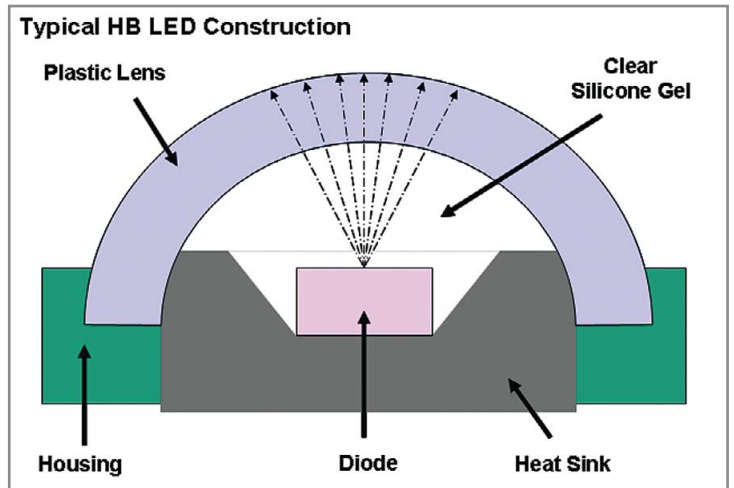

Figure 2: Cross-section of typical HB LED showing silicone gel.

Through the careful selection of polymers silicone gels can be formulated to produce a wide variation in RI. These silicones can then be selected to match the RI of the lens material as illustrated in Table 1.

Material	RI	ACC Silicone Gels	RI
Acrylate (PMMA)	1.49	QGel920	1.49
Glass	1.51	QGel92-14-1	1.519
Cyclic Olefin	1.53	QGel92-16-1	1.539
Polycarbonate	1.59	QGel92-18-1	1.549

When designing lighting packages the use of optically clear silicones to reduce the differential of the RI index is always beneficial. Standard optically clear silicone encapsulants and gels will have a RI value of 1.40, to achieve the higher values shown in the table specialist and more expensive polymer systems have to be used.

Silicones also offer additional benefits; they provide environmental protection against moisture, chemicals and vibration. They remain optically clear and flexible even when exposed to UV light and high temperatures. Many other chemical systems do not share this proven chemical stability and can cause product failure or reductions in performance over time.

### Remove the heat

Maintaining the correct temperature within the diode is fundamental if an LED is going to emit the correct type and amount of light. If this temperature is not maintained, the LED will also consume more power and suffer premature failure thereby removing all the reasons for using them.

In the quest for higher light output, LED's have increased in power and an increasing number of individual LED's are being packaged together to make affordable and technically acceptable replacements for conventional lighting sources. This trend increases the amount of heat produced and in turn the demand for more efficient forms of heat dissipation.



Designs will vary but in essence all involve some form of heat sink to dissipate the heat away from the diodes. It is the interface between the heat sink and diodes that calls for the use of thermal transfer compounds, without their use any air gaps regardless of how small will act as an insulator and prevent heat escaping. The benefits of using a heat transfer compound are shown in Figure 3 below:

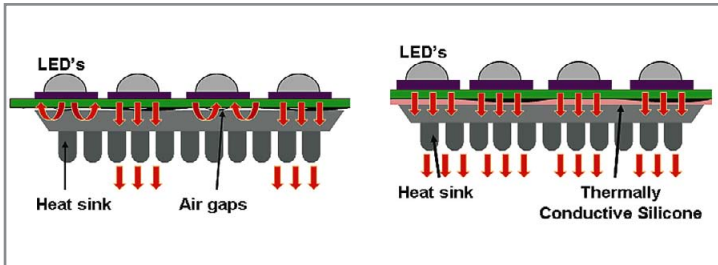

Figure 3: Insulating effect of air gaps (left). Improved thermal path to the heat sink (right).

Silicone heat transfer materials come in a wide variety of forms; liquid adhesives, sealants, pastes, gels and potting compounds. Choice of material will be driven by a combination of factors including:

- Thermal requirements
- Manufacturing processes
- Environmental operating conditions
- Need for additional functionality

## Why use Silicones

Silicone polymers and elastomers have particular inherent physical properties including:

- Wide operating temperature range -115 to 300°C (dependant upon material)
- Excellent electrical insulation properties
- Flexibility
- Hardness range, soft gels to moderately hard rubbers
- UV resistance
- Good chemical resistance
- Resistant to humidity and water
- No or low toxicity
- Easy to use

These natural properties can be further enhanced using fillers and chemical additives to provide additional features when needed, including flame retardancy, thermal conductivity, electrical conductivity and adhesion. Through the selection of polymers and fillers it is also possible to adjust viscosity and rheology and the final hardness and modulus of the cured rubber. Control of the curing regime and speed can be achieved using the silicone chemistry to produce both heat and room temperature cure (RTV) systems. Silicones can be supplied as 1- or 2-part systems. In short silicone compounds are very versatile and provide design engineers with a wide product choice.



# Minleon<sup>TM</sup>

**A Leading Manufacturer & Distributor of Quality Holiday, Decor & General Use LED replacement Bulbs and String lights**

LED professional

## LED Ceiling Panel



[www.minleon.com](http://www.minleon.com)

Minleon International is a leading manufacturer of high quality LED lighting products. Featured products include retrofit/replacement LED bulbs in the holiday, décor and general use markets. Minleon has an in-house professional design team for tooling, custom plastic molding, SMD and assembly. Minleon has a branch facility in the USA to warehouse product and provide hands-on customer service to its nationwide network of distributors and their customers.

## LED lamps



[www.minleon.com](http://www.minleon.com)

Minleon International Ltd.  
Dongken Town, Dongken City  
Guangdong Prov, China 523450  
website: [www.minleon.com](http://www.minleon.com)  
email: [info@minleon.com](mailto:info@minleon.com)

[www.minleon.com](http://www.minleon.com)

Minleon International USA Ltd.  
3920 Market Street  
Camp Hill, PA 17011  
Toll-free 866-670-0422  
email: [minleonusa@live.com](mailto:minleonusa@live.com)

## Silicone Thermal Transfer Materials – With Additional Functionality

In some engineers minds thermal interface materials are limited in use to provide a simple bridge between heat sink and the LED's but they can provide much, much more in terms of functionality and offer tangible benefits as an integral part of component design. These silicone thermal transfer materials can be formulated in a variety of ways in order to produce various types of material including adhesive sealants and encapsulation/potting compounds. Opportunities are opened up to use one material to achieve two three functions as shown in the following example:

The obvious benefits of having a thermally conductive adhesive enable you to permanently bond your component to some form of heat sink and eliminate the need for additional mechanical fixings. It will also prevent the possibility of movement and air gaps forming which will reduce performance. These products can also be used to form gaskets using FIPG (Formed in Place Gasket) techniques which will not only transfer heat but also form a seal against moisture and other environmental contaminants.

Using a flowable 1-part adhesive it is possible to apply a coating with thermal conductive properties. This approach has successfully been used to coat the back of LED lighting units and provide environmental protection and effectively remove heat from the diodes.

### Typical example demonstrating the benefits if using silicone materials

In the simple example shown in Figure 4, the array of LED's are housed in a metal unit. The PCB is held in position while a thermally conductive silicone encapsulant is applied. The flowable material is allowed to fill the void below the PCB providing an efficient pathway for heat to reach the metal housing and be effectively dissipated. The silicone will flow and completely fill all voids, thus removing insulating air gaps. It will remain flexible and provide a moisture proof seal around the cable entry point, in sum cases larger holes can be sealed using a silicone sealant prior to encapsulation.

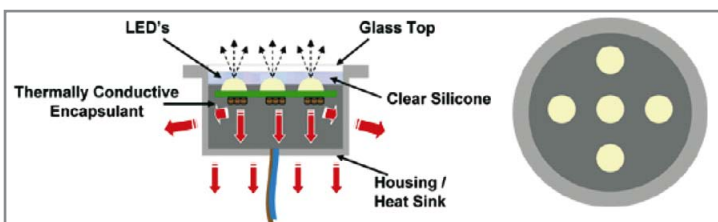

Figure 4: Cross section of LED light using silicone encapsulants (left) and top view of LED array (right)

The opaque encapsulant material is also allowed to fill above the PCB leaving the domed lens of the HB LED proud of the silicone; this can be very effective from a visual design perspective. After the encapsulant has cured a layer of clear silicone can be then applied above the LED lens to protect and improve light output. The glass cover can then be positioned while the silicone is still liquid or alternatively a harder silicone compound can be used to protect and seal above the LED's without the need of the glass cover. It is common to use a harder silicone compound in the manufacture of LED light bars (see Figure 5) to provide a clear protective cover over the length of the bar.

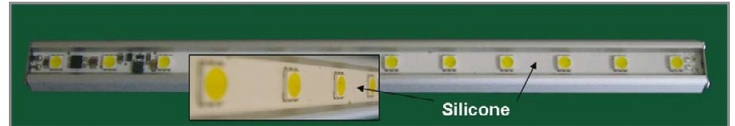

Figure 5: LED light bar sealed using a 40 Shore A optically clear silicone encapsulant.

## Silicone Chemistry

We will not go into too much detail regarding the chemistry but it is good to have a basic understanding when making the product selection.

### Two basic types of systems are used:

#### Condensation cure

2-part encapsulants use tin based catalyst systems which cure at room temperature and cannot be accelerated with heat, they are robust and generally unaffected by contaminants.

1-part RTV adhesives are moisture cure systems which use a variety of crosslinkers to produce the cured elastomer. Each type of crosslinker will produce a chemical by-product during the curing process. Acetoxy crosslinker systems are not recommended for use within electronics as the by-product is corrosive acetic acid.

#### Addition cure

Addition cure systems use platinum catalyst and can be formulated to cure at room temperature or with heat, additional heat can be used to reduce cure times.

The platinum catalyst is susceptible to attack from certain chemical compounds which in turn will lead to inhibition of cure, resulting in a partially cured product. Bringing the uncured material into contact with the following chemical compounds should be avoided during the manufacturing process; nitrogen, sulphur, phosphorus, arsenic, organotin catalysts, PVC stabilizers; epoxy resin catalysts, sulphur vulcanised rubbers, and condensation cure silicone rubbers.

In 1-part addition cure adhesive sealants, cure will only start when heat is applied and in most cases it requires temperatures above 80°C to cure the material, by elevating the temperature up to a maximum of 170°C, the cure speed will increase.

Adhesion is normally a little harder to achieve using these materials when compared with RTV's. Adhesion promoters are added to improve adhesion but these normally require the use of higher temperatures for slightly longer periods of time. For example, a typical adhesive may cure after 30 minutes at 100°C while elevating the temperature to 150°C for 30 minutes will ensure adequate adhesion to the substrate.

## Conclusion

Optimising light output and heat dispersion are essential for maximising LED performance. The versatility of silicone chemistry provides the LED design engineer with a variety of products that can be utilised improve performance and enhance production. Careful attention to the use of silicones throughout the design process will pay large dividends. ■



# Taiwan International Lighting Show

台灣國際照明科技展



## March 12-15, 2010

Taipei World Trade Center Exhibition Hall

[www.TILS.com.tw](http://www.TILS.com.tw)

Sponsor:



Bureau of Foreign Trade, MOEA

Organizers:



TAITRA

[www.taipeitradeshows.com.tw](http://www.taipeitradeshows.com.tw)



TLFEA

[www.lighting.org.tw](http://www.lighting.org.tw)

## Drivers

# Short Explanation of Critical Elements of a HB-LED Driver

> Rakesh Reddy, Application Engineer, Cypress Semiconductor Corp.

High Brightness LED (HBLED) technology is ushering a revolution fueled by increasing efficiency and reducing cost of operating luminaries. In comparison to alternate light sources, other attractive features such as longevity, ruggedness and capability of generating high CRI of tunable light, has secured a place for HBLEDs in almost all avenues of the lighting industry. The true potential of these silicon based devices can be unleashed by choosing a driver IC capable of meeting the flexibility and control required by today's applications. Since the quality of light output is intrinsically tied to the capability of the LED driver, it is important to choose a system that has the right specifications.

Today's HBLEDs typically have a nominal current rating of 300mA to 700mA. As the envelope of light output is pushed, devices requiring more than an Ampere are appearing in the market. In all LEDs, due to the voltage-current relationship and the binning approach used by manufacturers, a constant current source is used for accurate control of the light output. Choosing the right constant current regulator depends on the operating voltage of load and source, desired efficiency, and the cost and size of the system. A high-power resistor in series with LEDs would be the simplest form of current regulator. However, since it alone cannot adapt to changing source voltages or the non-linear VI characteristics of an LED, a closed loop system that changes the resistance based on output current may be used. In either case, the energy not used by the LED is dissipated as heat by the linear regulator leading to an inefficient system. In most HBLED applications, switching regulators offer better efficiency over a wide range of operating voltages.

HBLED lighting fixtures seeking to replace incandescent and fluorescent bulbs must provide better efficiency and quality of light while maintaining low costs. An integrated switching regulator used in lighting applications must require minimal external components and have good current regulation. While switching regulators can have diverse forms, they all operate using the same principle of moving small and controlled quantities of energy from the source to the load. The type of topology that is chosen depends on the type of conversion required. A boost topology is used when source voltage is lower than the required load voltage while a buck allows the source voltage to be greater than the load voltage and is typically used for driving LEDs.

The main control system in any buck regulator is the hysteretic controller. This block regulates the current through the inductor by turning on a switch when it is below the lower threshold and vice versa. A shunt resistor is a convenient method of sensing the current and by pairing it with a differential Current Sense Amplifier (CSA), a smaller resistance can be used minimizing power losses. The feedback from the CSA is used by the analog circuitry of the controller. These blocks can be arranged in various combinations and in Figure 1, different LED colors differentiate the topologies.

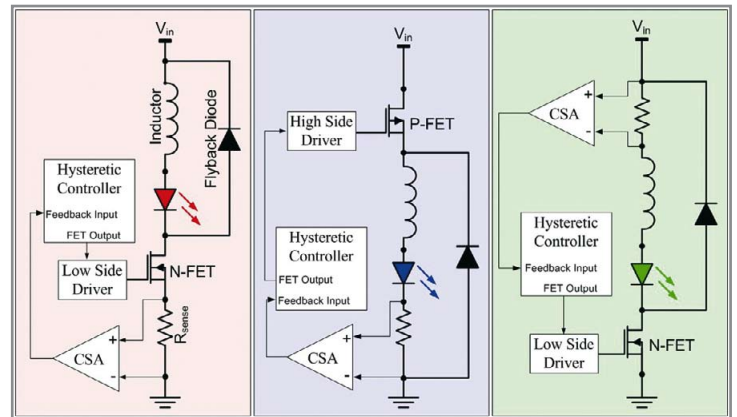

Figure 1: Three different flyback configurations and current sensing options.

In all three topologies, current flows through the inductor when the corresponding switch (Field-effect Transistor or FET) is turned on. When the current rises above a predetermined limit, the hysteretic controller on each topology turns off the FET. As the current in the inductor persists, it conducts through the flyback diode until it falls below the lower threshold and the FET is turned on again. A system capable of faster switching will require smaller inductors to store magnetic flux between alternate cycles. In Figure 1, the topology with the red LED is configured with a low side sense resistor located on the source pin of an N-FET. An inherent problem with this implementation is that current through the inductor can only be sensed when the switch is on. Once the current reaches the peak threshold and the switch is turned off, the hysteretic controller must use a timing circuit to turn the switch back on. If during the off cycle the falling current did not reach the lower threshold or overshoot it, the off-time must be adjusted until the loop is stable at required current ripple. As this technique has true hysteresis on only one side of the loop, it will not be able to quickly adjust to fast transients of source and load conditions.

A hysteretic control system that is capable of sensing both falling and rising edges requires the feedback loop to remain in the current path regardless of the state of the switch. In Figure 1, the topology used by the blue LED shows the sense element in the path of the inductor current in the charging as well as discharging phase. To achieve this, a high-side switch or P-FET is used. Because the  $R_{ds}$  (Resistance offered by the FET to current) is higher in P-FETs when compared to N-FETs, there is a loss in efficiency. Additionally, the high-side driver and the P-FET itself are typically costlier than a low side driver and N-FET rated for the same switching capability. Finally, in the topology used by the green LED, the position of the FET and sense resistor is swapped. This allows the use of an N-FET to increase efficiencies while the location of the sensing element allows inductor current to be sensed throughout the operation of the hysteretic controller.

Working as a system, the LED driver channel depends on five elements to create a topology that is efficient, robust and meets the demands of HBLED applications. Figure 2 shows the five building blocks supporting a Buck topology. The same blocks may be used for other topologies such as Boost, Buck-Boost, Single Ended Primary Inductor Converter (SEPIC) etc.

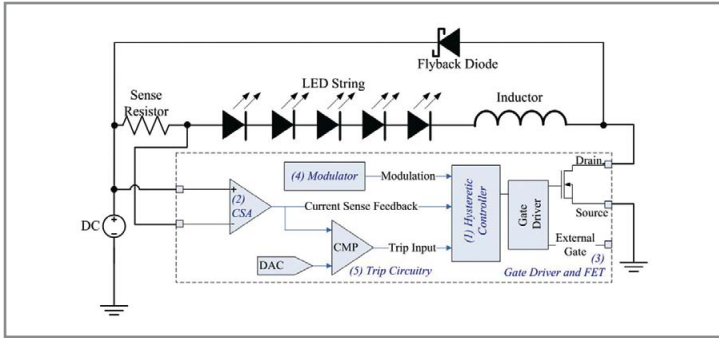

Figure 2: Buck topology example showing the five basic blocks of an LED driver.

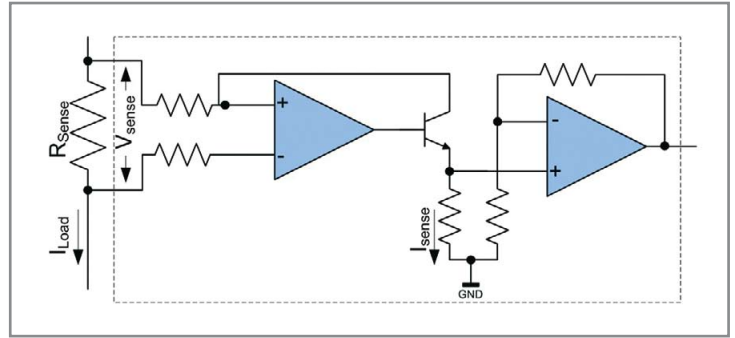

Figure 3: CSA example that allows differentially sensing of a voltage and level shifting to a reference voltage.

## Hysteretic Controller

As described above, the main function of the hysteretic controller is to regulate current through the LED. A reliable hysteretic controller may use a SR type flip flop where the 'Set' input is triggered when the current falls below the lower threshold and the 'Reset' input is triggered when the current rises above the upper threshold. By using Digital to Analog Convertors (DAC) to produce the reference voltages, a hysteretic controller can be made programmable. With resolution defined by the capability of the DACs, the higher and lower reference values can be controlled to change the position of the ripple current. Reducing the amount of ripple allowed in the channel decreases the ramp times thus increasing the switching frequency. Drivers capable of working at higher frequencies (ranging from 500kHz to 2MHz) can allow for significant reduction in cost and size of magnetics. In addition, the controller must be able to perform a logical AND of signals from the modulator and trip circuitry.

## Current Sense Amplifier

A high-side sense amplifier allows the hysteretic controller to sense both rising and falling current ramps of the inductor. Such a CSA needs to differentially sense the voltage and level shift it to the same reference voltage as the Hysteretic controller. Figure 3 shows a technique for such a CSA that cascades a differential amplifier, level shifter and a secondary amplifier stage. It operates by creating a current  $I_{sense}$  in the low voltage realm that is proportional to  $V_{sense}$  on the high side. An additional amplifier with adjustable gain can be used to obtain a signal whose voltage matches that obtained from the reference DACs in the Hysteretic Controller. A high gain setting in the CSA allows the use of low value sense resistors minimizing power losses. A choice between 20 and 100 should address the requirements of most HBLED designs. Since the CSA is sensing the rising and falling currents, it is important that sensor's bandwidth is greater than the switching frequency. When high bandwidth is not required, choosing a lower one will reduce the noise picked from the supply through the positive pin of the differential amplifier.

## Gate Driver and FET

As the choice of gate driver and FET are intrinsically tied to the maximum switching frequency possible and efficiency of the system, they have to be chosen carefully after a trade off between cost, size and performance of the design. A FET with lower  $R_{ds}$  will reduce conduction losses, and lesser gate capacitance will reduce switching losses. The gate driver must be able to drive the gate capacitance of the FET at the switching frequency desired. If the gate driver is not powerful enough, the ramps rate could be too slow causing the FET to operate in the inefficient linear region, and if it is too powerful, the FET could ring producing EMI emissions.

## Modulator

The modulator's output provides the dimming signal to the hysteretic controller. A high output from the modulator produces constant current at the LED while a low relates to zero current. The choice of modulation scheme should allow for a high degree of resolution to harness the potential of LEDs. As the human eye can perceive small gradients at lower intensity levels, an 8-bit modulation scheme will create undesirable and perceptible steps in an extended fade sequence. A higher resolution of 12 to 16-bit modulator requires a clocking frequency allows for a smoother gradient.

The modulator frequency must be high enough to allow for a refresh rate that is higher than the persistence of human vision. When using a 16-bit modulation at 700 Hz the modulator must be clocked at  $700\text{Hz} * 65536 \text{ cnts} \approx 45\text{MHz}$ . Today, different modulation schemes are available for driving LEDs. Pulse Width Modulation (PWM) involves representing the desired dimming quantity as a ratio of width of the pulse to the period of the pulse. Other modulation techniques like PrISM™ (Precise Illumination Signal Modulation) spread the dimming quantity in a pseudo-random fashion throughout the period of the pulse. Such a stochastic signal density modulation scheme spreads the energy throughout the spectrum reducing quasi peak emissions.

## Trip Circuitry

Various scenarios require the driver element to halt the constant current hysteretic control loop. Operating under sudden input voltage fluctuations and temperature gradients can affect the longevity and performance of the LED engine. A trip circuitry comprising of a programmable DAC and comparator can deliver the required logic signal to the hysteretic controller's AND function.

## Conclusion

The design of these five elements - hysteretic controller, current sense amplifier, gate driver and FET, modulator, and trip circuitry - has to be done very carefully. Dedicated and adjusted solutions can reduce the design-risks. Advancements in semiconductor technology are allowing for integration of these components into fast shrinking and inexpensive programmable controllers. For instance, the PowerPSoC™ family of parts contains hysteretic controller channels that can be setup to create various topologies to drive HB-LEDs. By coupling integrated drivers with an onboard microprocessor, the cost and form factor of a solution can be reduced with supplementary benefits associated with reduction in EMI emissions. ■

# LED professional – Patent Report

> Siegfried Luger and Arno Grabher-Meyer, Editors, LED professional

Intellectual properties play an important role in the still young and highly dynamic LED area. The number of patent applications and granted patents is continuously increasing and it's time-consuming to keep an overview. Therefore, LED professional publishes the bi-monthly "LED professional - Patent Report", which is released in conjunction with the LED professional Reviews. The report covers the US & EP granted patents in the field of LED lighting for the last two-month period. Every granted patent is highlighted with: a selected drawing (Derwent), the original patent title, a specifically re-written title (Derwent), the IPC class, the assignee/applicant, the publication number and date, and last but not least the original abstract.

With the "LED professional - Patent Report" it's easy to screen the IP-landscape, to check the "freedom-to-operate", to check if it is necessary to file an opposition, to monitor the competition or even to get inspired for making your own inventions.

## LED professional – Patent Report (LpR 16)

Period: Sept 1, 2009 – Oct 31, 2009

Regions: US & EU

Application: General Lighting

Granted Patents: 409

Pages: 186

The LED professional – Patent Report is only available for LED professional Review (LpR) digital subscribers. If you have a valid subscription, please download the report by following this link: "[LED professional – Patent Report \(LpR 16\)](#)".

To order or renew your digital subscription: Click [here](#) or see <http://www.led-professional-review.com>.

Inventors	Grtd. Patents
CURRAN, John W.	4
DENBAARS, Steven, P.	4
FAN, Ben	4
CHAKRABORTY, Arpan	3
CHUA, Soo Jin	3
DAILY, Christopher, George	3
LYS, Ihor A.	3
MORGAN, Frederick M.	3
RHOADS, Greg	3
SCHAUER, Udo	3
SIEMIET, Dennis	3
SIMON, David L.	3
TANAKA, Kenichiro	3
WAUMANS, Lars, R., C.	3
WEGH, Rene, T.	3
WELTEN, Petrus, Johannes, Maria	3
WENG, Joe	3

Table 1: Top Inventors.

Assignee	Grtd. Patents
PHILIPS	46
OSRAM	25
PANASONIC	10
CREE INC	9
IND TECH RES INST	6
DIALIGHT CORP	5
SAMSUNG ELECTRO MECH	5
ALTAIR ENGINEERING INC	4
FAN BEN	4
HE SHAN LIDE ELECTRONIC ENTPR	4
INSTA ELEKTRO GMBH	4
LEDON LIGHTING JENNERSDORF GMBH	4
NXP BV	4
SHARP KK	4
UNIV CALIFORNIA	4

Table 2: Top Assignees.

IPC	Grtd. Patents	IPC Description
H01L	161	Semiconductor Devices
F21V	113	Functional Features or Details of Lighting Devices
H05B	76	Electric Lighting
F21S	71	Not-Portable Lighting Devices
F21Y	38	Indexing Scheme Associated with Subclasses
F21K	23	Light Sources
G02B	20	Optical Elements
H01J	15	Electrica Discharge tubes
C09K	13	Materials für Applications
G02F	13	Devices or Arrangements

Table 3: Top Technologies based on IPC-R(4 digit) Codes.

Country	Grtd. Patent
US (Amerika)	161
DE (Germany)	53
JP (Japan)	52
EP (Europe)	42
KR (Korea)	36
CN China)	19
TW (Taiwan)	17
IT (Italy)	9
GB (Great Britain)	7
FR (France)	4
AT (Austria)	2
CA (Canada)	2
SG (Singapore)	2

Table 4: Top Priority Countries.

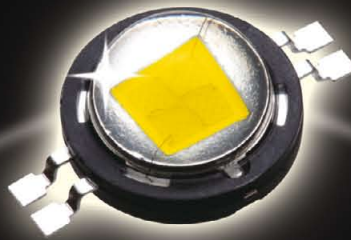

**Acriche**

World's First AC-Driven Solid State Light

Z-power LED



Lamp LED



"A Company of Good People"

Top View LED



High Flux LED



Chip LED

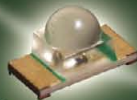

Side View LED



## Seoul Semiconductor...

is global leading LED maker.

is the center of global attention with cutting edge LED technology for the next generation lighting.

considers the value for customers as their top priority

designs sustainable future for the happiness of human beings.



**SEOUL SEMICONDUCTOR**

[www.acriche.com](http://www.acriche.com)

Headquarters +82-31-364-3787

China +86-755-8204-2307

Europe +49-69716-750111

Japan +81-3-5360-7620

North America +1-310-324-7151

# Lighting Quality & Energy Efficiency

March 14–17, 2010  
Vienna, Austria

## Highlights:

- Surveys of experimental projects
- Lighting techniques & scenarios
- Integrated approaches in Lighting Design
- Lighting quality criteria
- Future possible lighting schemes
- Methods to compare lighting installations
- Case studies of energy-efficient lighting
- Review of energy-efficient lighting control systems
- Energy efficiency & environmental compatibility

<http://vienna2010.cie.co.at>

For further information please contact:  
CIE Central Bureau, Kegelgasse 27/3, 1030 Vienna, Austria  
Phone: +43-(0)-1-714 31 87, Fax: +43-(0)-1-714 31 87-18  
Email: [vienna2010@cie.co.at](mailto:vienna2010@cie.co.at)