

**OLED Technology & Market Trends**  
**Digital LED Systems - Interview**  
**Tunable White Light**  
**TRIAC Dimming**



★ CREE XLAMP® LEDS ARE SIMPLY THE

# BRIGHTEST

MOST ENERGY-EFFICIENT LEDS AVAILABLE.\*



"AVAILABLE" MEANS—YOU ORDER THEM, WE SHIP THEM.  
THAT PART IS SIMPLE TOO.

Find a Cree Solutions Provider or authorized distributor at  
[www.cree.com/xlamp](http://www.cree.com/xlamp) or call 800-533-2583.



up to **1500** lm  
@ 20W  
XLamp®  
MP-L LEDs



up to **855** lm  
@ 10W  
XLamp®  
MC-E LEDs



up to **493** lm  
@ 5W  
XLamp®  
XP-G LEDs



Photo depicts an actual installation using Cree XLamp LEDs. Cree, XLamp and the Cree logo are registered trademarks, and Lighting The LED Revolution is a trademark of Cree, Inc.





# Improved LED Drivers

During the last couple of years LED performance has shown rapid improvements and this has been the trigger for so many lighting innovations. But what are the requirements for LED driver and controller improvements?

Technically, lighting applications LED drive circuits have to keep up with those higher requirements. Fairchild PCIA lighting director Lee Peng said: "LED lighting driver circuits are focusing more and more on the stability of brightness, power conversion efficiency, the pursuit of higher efficiency, higher integration and smaller form factors". Besides driver performance improvements, this key component is targeted with system requirements coming from the applications. One big topic is the interconnection with standard TRIAC phase cutting dimmers. For this reason, this issue contains a number of solutions. When it comes to advanced lighting systems, linking to interfaces such as DMX, DALI, Ethernet or other building management bus-systems seems to be important for modern controlling schemes. Physically, drivers should be able to work either wired or wireless with system controllers, sensors and other actors.

When looking inside an LED driver, many additional questions arise, like: What about the galvanic isolation? Which topology is the best approach for a specific application? What about the component stress and live time requirements? What about the off-line drivers in regards to mains regulations such as EMI and harmonic distortions? And also, should a driver be digital or analogue?

To answer the latter questions we have interviewed leading experts and companies in this field.

LED drivers are becoming more and more a key component in LED lighting systems. The quality, the flexibility and innovative solutions will depend strongly on sophisticated LED driving schemes. Software and software upgrading options may play an important role in the future. These developments are all made in a "standard-free" area – which makes it difficult to build up universal platforms and guarantee interchangeability.

Again, I would like to invite you to come and meet us personally at the "LED professional Symposium + Exhibition 2011" on Sept. 27-29 in the Festspielhaus (Festival House) in Bregenz, Austria. The symposium will be focusing on LED lighting technologies.

Technology is a key driver for innovation – that is the reason why we are bringing technology experts from the fields of LEDs, optics, drivers, ICs and thermal management together to present and discuss their "Winning Technologies". The LpS 2011 will be the ideal platform for you to gather information, get key contacts and meet the leaders.

**Don't forget: "Call-for-Papers" ends on February 1<sup>st</sup>, 2011.**

Exhibitors and sponsors are welcome to reserve their packages. For detailed information please visit our symposium website: [www.led-professional-symposium.com](http://www.led-professional-symposium.com)

We would very much appreciate your feedback about *LpR*. Let us know what you like or tell us how we can improve our services. Please keep in mind that you are also welcome to contribute your own editorials.

Yours Sincerely,

A handwritten signature in blue ink, appearing to read 'S. Luger', with a long horizontal stroke extending to the right.

Siegfried Luger  
Publisher

# Content

■	Editorial	p 1	News - PROJECTS	p 4
	Imprint	p 64	News - PRODUCTS	p 5
			News - RESEARCH	p 21

■	<b>EVENTS</b>	p 24		
	The Display Industry Drives OLED Technology	p 24		
	by Alan R. Mills, LED professional			

■	<b>INTERVIEW</b>	p 28		
	"The Future of LED Systems is Digital"	p 28		
	Interview with Peter Deixler, Philips Eindhoven			
	by Arno Grabher-Meyer, LED professional			

■	<b>APPLICATION</b>	p 32		
	Intelligent Lighting (Part II): From Definition to Implementation	p 32		
	by Osama Mannan, Future Lighting Solutions			

■	<b>TECHNOLOGY</b>	p 38		
	Understanding the Pitfalls of Tunable White Light LED Systems	p 38		
	by Madhan Kumar, Sachin Gupta, Cypress Semiconductors			

■	<b>ELECTRONICS</b>	p 42		
	Triac Dimmable Primary Side Regulated Flyback	p 42		
	by Michael Weirich, Fairchild Global Power Resource <sup>SM</sup> Center EP			
	Facts about Dimming	p 48		
	by Gregg Sheehan, Light-Based Technologies			
	Charge Controlled LED Drivers	p 56		
	by Jens Göhring, diltronics			
	Needed Accuracy of an LED Power Supply	p 60		
	by Christopher Richardson, National Semiconductors			

## Advertising Index

Cree	p C2
LED professional Symposium	p 3
Recom	p 11
Signcomplex	p 17
Infineon	p 22
Instrument Systems	p 23
Kingbright Electronic Europe	p 31
LED China	p 37
LED Lighting Taiwan	p 41
Signcomplex	p 46
Guangzhou Int. Lighting Exhibition	p 47
LEDLink	p 51
OLED Insider	p 55
Curamik	p 58
Lighting Japan	p 59
Green Lighting Shanghai	p C3
Tridonic	p C4

**LED**  
professional

[www.led-professional-symposium.com](http://www.led-professional-symposium.com)

 **symposium** + Expo

**2011** LpS

# LED Lighting Technologies

**27-29 September 2011**  
**Festspielhaus Bregenz / AUSTRIA**

**DON'T MISS THE  
DEADLINE!**  
Call for Papers  
ends Feb. 1, 2011

LEDs & OLEDs

Optics

Drivers

Thermal Management

Testing

Contact Luger Research e.U. / LED professional Austria +43 5572 394489 [symposium@led-professional.com](mailto:symposium@led-professional.com)

## Energy Gateway Project at the Field Museum of Natural History in Chicago, Illinois

The U.S. Department of Energy (DoE) has published a report from a demonstration conducted at the Field Museum of Natural History in Chicago, Illinois, to evaluate the feasibility of replacing halogen lamps with LED lamps. It forms part of the DoE's GATEWAY project series which demonstrate real world experience of LEDs.

This GATEWAY study, carried out in late 2009, compares lighting performance, economic performance, and energy consumption of halogen and LED accent lighting solutions. Xicato Spot Modules in LX2024 series luminaires from Lighting Services Inc. were used in the study, carried out as a collaboration between the The Field Museum of Chicago and the United States DoE represented by Pacific Northwest National Laboratory (PNNL) in late 2009.

In this project, 32 halogen track luminaires used to light an enclosed gallery exhibit were replaced with an LED system using 26 track fixtures.

Key findings include:

The LED system resulted in 63 percent energy savings compared to the halogen system and produced comparable illuminance on the lighted artifacts.

The simple payback for the overall LED system compared to the halogen system was roughly 3.3 years and was further reduced to only 2.4 years when considering the lower heat output from the LED luminaires and associated HVAC energy savings. The payback calculation considers the longer life of LEDs, lower maintenance costs and that fewer LED luminaires are needed to generate an equivalent amount of light compared to the halogen fixtures.

Because the LED luminaires used do not emit energy in the infrared or ultraviolet regions of the electromagnetic spectrum, they are expected to be less detrimental to some museum artifacts. ■



**Xicato Spot Modules are used in the LX2024 series luminaires from Lighting Services that light up the T. Kimball and Nancy N. Brooker Gallery at the Field Museum, Chicago**

## Bridge's All-White Light Show with Luxeon-Based LED Fixtures

An all-white interactive LED light show that plays nightly on the curvy sunroof of a pedestrian bridge in the former Soviet Union is powered by 1,208 custom LED fixtures containing 6,040 high-power LUXEON Rebel LEDs from Philips Lumileds. The fixtures were designed and built by Netherlands-based Primo Exposures and RENA Electronica, with all LEDs supplied by Future Lighting Solutions in the required 4200 K color temperature range in just two weeks to ensure color uniformity.

The Bridge of Peace in Tbilisi, Georgia – a city of 1.5 million – was designed by Italian architect Michele De Lucchi with a lighting design created by France's Philippe Martinaud. The bridge structure was built in Italy and shipped to Tbilisi in 200 trucks. The lighting was installed on site in Georgia as the bridge was being assembled.

The luminaires in the roof were built to order by RENA – based on that company's configurable Vincent Ledline fixture design – with five cool white LUXEON Rebel LEDs per module, a Carclo elliptical beam optic, and a patent-pending louver system designed by Primo to direct the beam as well as conceal the point source.

RENA's customizable off-the-shelf design offered rapid delivery that met Tbilisi's tight timeline, a small footprint enabled by the compact LUXEON Rebel package, and proprietary two-wire power/data connectivity that expedited installation by eliminating three additional wires typically required for power and communication.

Each of the 1,208 fixtures in the sunroof represents its own dimmable DMX channel and is programmed through a control interface designed by RENA. The finished fixtures play four different lighting programs every hour from 90 minutes before sunset until 90 minutes after sunrise, illuminating the Mtkvari River in a dance of 21<sup>st</sup> century light that serves a striking counterpoint to the historic buildings on either bank. ■



**The modern bridge with its dancing white lights forms a striking contrast with the historic buildings in this capital city of 1.5 million**

## New Bridgelux Pre-Wired LED Arrays Further Simplify Design Integration

Bridgelux Inc., a leading developer and manufacturer of LED lighting technologies and solutions, is further simplifying the LED light source integration process for luminaire manufacturers with the introduction of new wiring options for its rectangular ES and RS Array Series solid state light sources. This option further enhances the plug and play simplicity delivered by these arrays, helping to facilitate quick design cycles and ease system-level integration challenges for Bridgelux customers.



**All ES and RS Array Series products out of the Bridgelux portfolio are now available with the pre-wired option**

The new wiring option provides two wires soldered to the electrical contact pads on the LED arrays. This wiring option may be ordered with all Bridgelux rectangular ES and RS Array Series, which deliver between 800 to 4,500 operational lumens in all available color temperatures. Providing pre-wired arrays simplifies the electrical integration of the light source into the lamp or luminaire, enabling Bridgelux customers to use interconnection methods common to the lighting industry and avoid introducing soldering processes in their factories.

“Our primary focus at Bridgelux is to make LED technology easy to use for our general lighting customers,” said Mick Wilcox, Bridgelux product manager. “Providing this wiring option eliminates manufacturing process steps and reduces product development risks and overall system costs. Our customers can bring new energy-efficient, high quality lighting products to market faster to meet the rapidly increasing market demand for solid state lighting.” ■

## Cree Introduces Lighting-Class LED Arrays to Accelerate Indoor LED Lighting

Cree, Inc., a market leader in LED lighting, announces the industry’s first lighting-class LED array. The XLamp® CXA20 LED array is the first lighting-class array aimed at accelerating the LED lighting revolution and can enable a 60-watt A-lamp equivalent while consuming just 11 watts.



**With a compact 22 mm x 22 mm footprint, the new CXA20 LED array delivers up to 2,000 lm at 27 watts, with a 3000-K warm-white CCT**

“We are impressed with Cree’s new XLamp LED array,” said PK Li, OPTILED Lighting International, Ltd., Director of Product Development. “They combined lighting-class performance, unequaled in the market, with an ease-of-use that will enable us to quickly develop both our new A19 lamp and down light products.”

With a single, uniform optical source, compact 22 mm x 22 mm footprint, and simple two-screw attachment, the CXA20 array can simplify the manufacturing process for customers who require a single component in their light-engine design. When used in a traditional down light application, luminaires based on the CXA20 are delivering 38-percent more illumination than a 26-Watt CFL or a 100-Watt incandescent bulb, while consuming a mere 14 Watts.

“Cree continues to bring the broadest family of lighting-class LEDs to market, ensuring that lighting applications have optimized LED light sources,” said Norbert Hiller, Cree vice president and general manager, LED Components. “For lighting manufacturers seeking Cree lighting-class performance and also looking to simplify the design and manufacturing of their indoor LED lighting, the CXA series of LED arrays can be an ideal solution.”

The CXA20 LED array delivers 1050 lumens at 11 watts, or 2000 lumens at 27 watts, with a 3000-K warm-white color temperature. Samples are available now with standard lead times with production volumes targeted for late Q1 calendar 2011. ■

## New Citizen LEDs for Lighting

Citizen Electronics Co., Ltd. (Head Office: Fujiyoshida City, Yamanashi Prefecture. President: Yoshihiro Gohta) has developed the CL-L330 series (26W type) and CL-L340 series (41W type) of white LEDs for lighting, of which the luminous flux per LED lamp is more than twice that of the conventional model.



**Citizen’s new and powerful CL-L330 series (26W type) and CL-L340 series (41W type) of white LEDs for lighting**

LED lighting has been in the spotlight as LED bulbs are commercially available. However, in most cases it is difficult to provide enough luminous flux for applications with only one LED. Therefore, it is necessary to place two or more LEDs in lights. In such cases, the area in which LEDs are to be placed becomes larger and accordingly the size of the light also tends to become larger. In addition, there is another negative effect. When there are two or more light sources, design to control light such as that of the reflection plate becomes complex.

The newly developed products resolve these problems by dramatically increasing luminous flux per LED and contribute to miniaturized lights and simplified optical design. It is also possible to expand lighting applications substantially where only one LED is used.

### High luminous efficacy:

In general, for LEDs, the more power supplied to a product, the lower luminous efficacy is likely to become. In response to this problem, we can combine high luminous flux and high luminous efficacy by mounting a number of compact light-emitting dice, of which luminous efficacy is relatively high, in one LED package through utilization of “Citizen



Electronics" specialized high-density mounting technology. The new products, both 26W and 41W types, provide the same high luminous efficacy as that of our conventional model (13W type) which has the highest luminous efficacy of our products.

5000K color temperature type:  
26W type: 104 lm/W, 41W type: 105 lm/W  
3000K color temperature type:  
26W type: 73 lm/W, 41W type: 73 lm/W

#### Thermal resistance:

The highest level of heat dissipation has been improved by 30% over that of the conventional model. As a measure against heat generation that has significant effects on the service life of LEDs, we have achieved the lowest level of thermal resistance of our LED products, and effective heat dissipation processes are provided, such as transferring heat to a heat sink, etc. In addition, since the whole rear face of the LED package can be used as a heat dissipation route, it is possible to diffuse heat promptly.

26W type: 1.7°C/W  
41W type: 1.0°C/W

#### Color rendering:

For white LEDs, there is a trade-off between color rendering and luminous efficacy. Color rendering indices are set for the new products by color temperature, based on main applications.

5000K color temperature type:  
Ra67 (priority placed on luminous efficacy)  
3000K color temperature type:  
Ra83 (priority placed on color rendering)

#### Applications:

The 5000K-color temperature (cool color) type is intended mainly for exterior illumination where priority is placed on luminous efficacy. For example, this type is suitable for streetlights, projectors and advertising lights. The 41W type provides, with one LED lamp, the same high luminous flux as that of a general 100W mercury lamp. Therefore, it is expected to reduce power consumption by about 60%. The 3000K-color temperature (warm color) type is intended mainly for interior illumination where priority is placed on color rendering. For example, this type is suitable for down lights for base lighting or spotlights for product rendition. The 41W type provides, with one LED lamp, the same high luminous flux as that of a general 150W halogen lamp. Therefore, it is expected to reduce power consumption by about 70%. ■

## Achieve Efficient Driving Circuit Design in LED Lighting with Custom EdiPower®II Series

Edison Opto offers custom design options to its EdiPower®II series. Based on various application requirements, the multi-chips EdiPower®II package can be adjusted in total power, operating current and driving voltage of choice.



**Edison Opto offers custom design options to its EdiPower®II series for total power, operating current and driving voltage**

Standard EdiPower®II includes four types of models: 4-6W, 8-15W, 16-24W and 30-50W. The custom EdiPower®II package can be designed to allow flexibility in adaption to different power source driven parameters such that the package can enable operation in high voltage. This kind of specific package not only simplifies the power circuit needed to drive the package, but also enhances the power circuit efficiencies.

Power circuit design for the custom high voltage EdiPower®II series is especially easy and cost-effective. Through proprietary LED package process and experiences, the efficiency of the package can reach up to 120lm/W; while the power circuit solution can also yield higher efficiency because less heat is being generated by the difference in power loss associated with voltage drop from the input source to the LED package. Custom high voltage designed EdiPower®II is ideal for application together with integrated circuit design within luminaries or light bulbs. For the generated heat from the circuit to be reduced, the integrated heat-sink would result in higher heat capacity and dissipation. Heat from LEDs would sustain a longer lifetime for reduced temperature generated from the power circuit. The number of applications for EdiPower®II include down-light and retrofit light bulbs. ■

## LedEngin Launches its Highest Performance LED Emitter Platform

LedEngin, Inc., a leader in high performance LED lighting solutions, announces its latest and highest performance platform yet - the LZP-series. The multi-chip emitter generates up to 5500 lumen (CCT of 5500K) and 3000lm (CCT of 3100K) in an unprecedented compact 12mm x 12mm package. LZP-Series systems replace 35W metal halide (MH) bulbs or 50W high pressure sodium (HID) bulbs achieving the high flux required in applications such as High Bay lighting, architectural lighting, street/area lighting and Stage & Studio moving heads.



**The LZP series emitter, copper Star PCB and TIR lenses are available for sampling and volume production**

#### Key features of LedEngin LZP series:

- 24 LED dies configured in four strings of six dies in one series
- Maximum current of 1A per die totaling up to 90W power
- High luminous efficacy at 350mA per die of 95lm/W (5500K) and 70lm/W (3100K)
- Compact 12mm x 12mm form factor for high luminous density
- L70 lifetime > 50,000 hours
- Available in CCT 2700K, 2900K, 3100K, 4100K and 5500K
- Typical CRI of 85 and R9 of 30 for true color rendering
- Color point stability 7x better than the requirement of Energy Star
- Emitter junction to case thermal resistance of 0.35K/W
- Offered with or without glass dome
- LedEngin designed high efficiency TIR lens products with 15°, 23° and 35° beam angles
- LedEngin-designed, extremely low thermal resistance, copper core PCB (0.1K/W) mounting option to minimize design time



LedEngin high lumen density products are complemented with proprietary TIR high-efficiency optics to produce maximum lumens in beam for superior Lux on Target™ performance. LedEngin LZP-series when coupled with LedEngin TIR optics exceeds the luminance of competing LED solutions by 6-10 times. The compact optical system overcomes a major challenge in flood and spot lighting applications that cannot be achieved with larger LED sources or current technologies such as MH or HID. Equally important, the single high lumen density emitter in combination with a single high efficiency TIR optic produces a superior light quality, homogeneous beam pattern and crisper image for a more natural perception of the light.

“With the introduction of our new LZP-series, LedEngin pushes the lumen density performance to record high levels. With brightness performance equivalent to MH and HID levels, our customers can take advantage of our robust packaging and long lifetimes to improve the overall cost of ownership for a new class of lighting applications”, said Xiantao Yan, Founder and CTO of LedEngin. “Our LZP-series emitters have the same known robustness, lumen maintenance performance, color quality and color point stability that customers have come to value with LedEngin products.” ■

## ASELight STAR to Replace Discontinued OSRAM OSTAR

At Electronica 2010 in Munich Asetronics introduced the ASELight STAR, a replacement product for OSRAM OSTAR Lighting. The successor product has been developed in collaboration with OSRAM Opto Semiconductors on the proven basis of the previous LED and will be produced and sold exclusively by Asetronics.

The new OSRAM OSTAR Lighting Plus LED light source is the basis for the ASELight Star. It is equipped with the latest OSRAM chip generation and guarantees well-known reliability. The module is based on the identical platform (Hexagonal) as the previous product, OSTAR Lighting. This makes it possible to use the new product as a 1:1 replacement in an existing system. The new four-chip version achieves a brightness of 700lm at 700mA. The proven hexagonal

design allows a high packing density, making it possible to combine several ASELight STAR modules at the same time, like a mosaic, in order to achieve large lighting surfaces with a wide variety of contours.

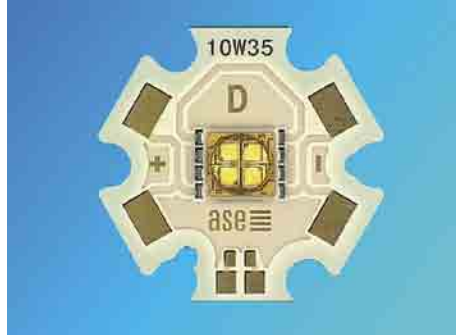

**Asetronics manufactures a successor for Osram's obsolete OSTAR, the ASELight STAR**

The ASELight STAR can be easily fitted with screws or clips. The power cable can be soldered or connected using clips.

With color temperatures of 3000K (warm white) and 6500K (cold white) it can be used for a wide range of applications. Additional color temperatures will be added at a later date. ■

## New High-Efficiency Cree XLamp® LED Can Reduce Initial Fixture Cost

Cree, Inc. announces the commercial availability of XLamp® XP-E High Efficiency White (HEW) LEDs. The new high-efficiency components extend the light output and efficacy of the award-winning XLamp XP-E LED family, enabling fixture designs that can use up to 50 percent fewer LEDs, which can help drive down costs for fixture and bulb manufacturers while delivering the same system performance.



**Cree's updated XLamp XP-E not only provides higher efficiency and luminous flux but also lower thermal resistance to improve thermal management**

XP-E HEW LEDs are optimized to lower initial costs for diffuse lighting applications, such as LED replacement lamps and down-lights. For example, an A-19 lamp that uses XP-E LEDs could be re-designed to use half as many XP-E LEDs while maintaining the same efficacy.

“One of the major barriers to LED lighting adoption and design remains upfront cost,” said Paul Thieken, Cree director of marketing, LED components. “By enabling designers to use brighter, precisely-optimized LEDs for each particular application, Cree is helping lower costs and further simplifying and shortening the LED fixture design cycle.”

XLamp XP-E High Efficiency White LEDs are the first high-power LEDs featuring Cree's new Direct Attach™ LED technology. Direct Attach technology is Cree's unique, next-generation LED chip technology that delivers higher flux, lower forward voltage, and lower thermal resistance.

“With 500 percent more die-attach area and an order-of-magnitude less die under-fill, Direct Attach technology is far more robust than any other LED flip chip technology in the market today,” said John Edmond, Cree director of advanced optoelectronics. “For our customers, these attributes, combined with the performance advantages of Direct Attach technology, can translate to brighter, more reliable lamps and fixtures, developed at a lower cost.”

XLamp XP-E High Efficiency White LEDs deliver up to 148 lumens in cool white (6500K) and 114 lumens in warm white (3000K) at 350 mA. In addition to light output and efficacy improvements, XP-E HEW LEDs feature a reduced thermal resistance of 6 °C/W. XP-E HEW LEDs are available in the same white variations as XP-E LEDs, including Standard White, Outdoor White and 80-CRI White.

XLamp XP-E High Efficiency White LEDs are available now in sample and production quantities with standard lead times. IES LM-80 data for measuring lumen maintenance of LED light sources, for XP-E HEW LEDs, is targeted for availability in February 2011. ■

## New LED Vega Series from GlacialLight

GlacialLight, a sub-division of the experienced technology manufacturer GlacialTech Inc., is excited to release an all-new, environmentally-friendly product – the LED Vega Series, a direct replacement for halogen AR111 lamps. With GlacialLight's specially-designed LED driver on board, the brand-new GL-AR111 LED Vega Series is compatible with all electronic transformers and can be placed in any halogen AR111 lamp socket immediately.

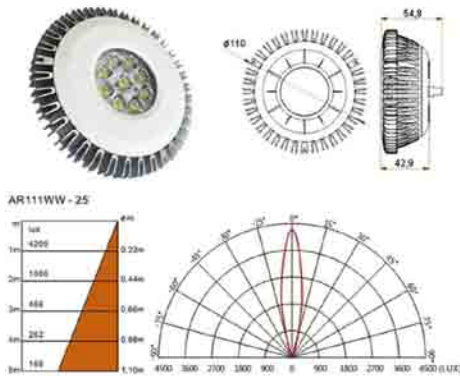

### The LED Vega Series is a direct replacement for halogen AR111 lamps

The halogen AR111 lamps generally require more energy and have significantly shorter life-spans than GlacialLight's brand-new LED Vega Series. In fact, GlacialLight's GL-AR111 LED Vega Series lamp has extremely low-level of heat radiation so users can actually see a reduction, not only in their lighting energy bill but their cooling bill as well. Rated at over 50,000 hours of life, once a GL-AR111 LED Vega Series lamp is placed, it is going to be a long-enough time before the question of replacing even crosses your mind. Able to accommodate an input voltage of 12V±10% provided by either an AC source or a DC source to power the inbuilt LED driver, the GL-AR111 LED Vega Series are more convenient and flexible than the halogen AR111 lamps confined to an AC source.

Thinking of the environment, GlacialTech designed the GL-AR111 LED Vega Series to contain no hazardous chemicals, such as mercury, or harmful radiation emissions such as UV or IR, making these more eco-friendly than the traditional incandescent lighting fixtures. With a power conversion efficiency of greater than 80%, GlacialLight is extremely excited to give consumers the LED Vega Series – an economically and environmentally-friendly lighting solution.

The differences between the two models are: GL-MR1605WH-WW has a Correlated Color Temperature (CCT) of 3000K while GL-MR1605WH-CW offers 5000K; the Luminous Flux of GL-MR1605WH-WW and GL-MR1605WH-CW are 250 lm and 360 lm, respectively; and finally, the warm white displays an illumination of 250 lux at 1m while the cool white bulbs are brighter with 360 lux at 1 m.

### Specifications:

- Power Consumption: 12W
- CCT: 3000K/6000K
- Luminous Flux (Lm): 520/650
- Luminance(lm/W) : 43/54
- Beam Angle: 25°
- Input Voltage: 12V AC/DC
- CRI > 75
- Base: G53

### Features:

- Direct replacement for any halogen AR111 lamp
- Compatible with electronic transformers without LED drivers
- Low power consumption – energy-saving green product
- Power conversion efficiency > 80%
- Long lifetime > 50,000 hrs
- Eco-friendly: RoHS Compliant, No UV, no IR, & no mercury
- For indoor use only

Design of LED lighting products is based on three core technologies including electrical design (LED drivers), mechanical design (cooling devices), and optical design (lamp holders), respectively performed by the GlacialTech family. With the three core technologies in hand, GlacialTech manufactures excellent LED lighting products you can trust. ■

## NeoPac Unveiled 8 inch Wafer Level Packaging Technology for LEDs Illumination

NeoPac Opto, Inc. a Taiwan based technology-driven LEDs lighting company recently announced its newly developed technology on 8 inch silicon-based wafer level package (WLP) for LEDs illumination, which is derived from its patented NeoPac Universal Platform and LEDs Standard Light Sources.

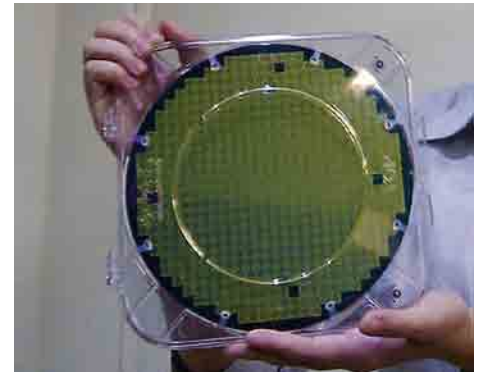

### NeoPac 8 inch silicon-based wafer level package (WLP) for LEDs delivers 500,000 maintained lumens on a single wafer

This 8 inch semiconductor manufacturing process is for NeoPac's unique ultra-high-power, multi-chip-module, single-packaged and point-like-source LEDs, or the so-called NeoPac Emitter. By coupling the NeoPac Emitter together with its patented, highly effective micro heat pipe based heat-dissipation mechanism, a sustainable LED standard light source, so-called NeoPac Light Engine is available for LED general lighting. The integrated ultra high brightness NeoPac Light Engine is actually made by a system-in-package (SIP) approach.

LEDs WLP (Wafer-Level-Package) is a semiconductor process that LED chips can be directly mounted along with a phosphor coating, wire bonding, and packaging processes on a whole silicon wafer. More than 480 pcs multi-chips-module (MCM) consisting of 3,840 pcs LED power chips can be automatically mounted for the NeoPac Emitter on a single 8 inch silicon wafer.

NeoPac plans to bring this advanced LED packaging technology into mass production in 2011. "The 8 inch WLP approach will drive the advancement of NeoPac's currently far-beyond-leading technology for LED illumination far ahead into a new era", emphasized Jeffrey Chen, Chairman and CEO of NeoPac Opto.

Each NeoPac Emitter can emit maintained lumen at 1,000 lm. Most importantly, the standard light source will suitably fit any secondary optics design for a variety of LED illumination applications owing to the intrinsic merits of the lighting characteristic of point-like-source. Furthermore, the effective "useful life" (L70) of such a light engine can sustain much longer than 60,000 hours. By this new WLP manufacturing technology, it's possible to deliver an amount of higher than 500,000 maintained lumen on a single 8 inch

silicon wafer. According to NeoPac's sustainable technology roadmap and LED chips' lumen efficacy improvement, it is estimated that the package on the same 8 inch silicon wafer can deliver a total maintained lumen output of up to one million (1 M) lumen 2 years later. This technology is about to enable the mass-production of LED lighting, which can substantially reduce the manufacturing cost in quantity. ■

## BetaLED's Essentia™ Downlights Offer Largest LED Selection and Highest Lumen Package

BetaLED is producing a new line of interior architectural downlights for commercial and high-end residential use. Essentia interior LED downlights offer a variety of warm interior correlated color temperatures (CCT), a wide range of LED counts, an unbeatable lumen package and wide, medium and narrow optics including adjustable and wall-wash. The versatile product selection allows Essentia lighting to be tailored for each unique application.

"We merged our best practices in renowned BetaLED product benefits with years of innovation from our Kramer interior luminaires to develop the best and most complete line of interior LED luminaires," said Christopher Ruud, president of Ruud Lighting. "The Essentia product brings to market what customers want out of an ideal interior LED light source. Essentia delivers advantages that we haven't seen offered in the commercial industry."



**One-for-one replacement of 500 Watt T4 Quartz luminaires with 15 Essentia medium distribution downlights (42 LEDs each) at St. Catherine's High School Auditorium**

Essentia luminaires earned acceptance in the Illuminating Engineering Society (IES) 2010 Progress Report. Inclusion in the notable report recognizes the product as a unique and significant advancement to the art and science of lighting. Essentia was presented at the annual IES conference held November 8 in Toronto, Canada.

The series of luminaires can be easily upgraded as LED technology advances with a replaceable light engine and optics. The complete line includes an unbeatable LED performance package and is designed with exceptional features:

- Standard 0-10V dimming control
- 4-, 6- and 8-inch square and round apertures
- 1,200 to 5,000 lumens delivered
- Multiple color temperatures available
- Narrow, medium and wide distribution patterns
- 45 degree cut-off
- L70 of greater than 50,000 hours

The new Essentia interior luminaire series joins the successful BetaLED product family of well-known exterior brands THE EDGE® area luminaires, LEDway® streetlights, and 304 Series™ luminaires for interior and exterior use. Essentia luminaires are currently available for distribution in North America. Since 2007, BetaLED has ushered in LED development and set industry milestones with a commitment to reduce energy use and improve lighting performance through the advancement of LED luminaires. BetaLED continues to raise the bar for design and performance excellence as technology and product lines grow and expand. ■

## Qnuru Unveils the Lighting Industry's Highest Performance Consumer-Ready LED Bulbs

Qnuru™, the premier provider of energy efficient digital lighting solutions, today launched the Qnuru Prism™ product family of 44 LED bulbs for residential, office and light commercial buildings. Designed to fit the 4.7 billion U.S. light sockets, Prism LED bulbs consume one-fifth the energy of incandescent lamps, generate up to 1,080 lumens and, with normal use, have a service life of 50,000 hours, compared to 2,500 hours for incandescent bulbs and 15,000 hours for compact fluorescent lamps (CFLs). Stylishly designed to resemble traditional light bulbs and fit standard sockets, the Prism product family includes A, B, MR, PAR, R, and T8 Series LED bulbs. Prism LED bulbs are available in warm white, cool white and dimmable variants.



**Qnuru's Prism LED bulbs series covers all relevant form factors from the small MR11 to A19 globe and PAR lamps**

Based on Cree XR-E LEDs, Qnuru's Prism LED bulbs generate negligible heat, turn on instantly, are flicker free, and emit no UV radiation. All Prism bulbs are rigorously tested, UL Listed, RoHS Compliant, approved by CE and come with Qnuru's 3-year replacement guarantee. Because they contain no mercury, they can be responsibly recycled with other metals and glass. The complete Prism product line can be purchased from Authorized Qnuru Dealers or online through the Qnuru website. Qnuru is part of the Noribachi Group, a clean technology private equity firm.

Lights Out for the 60W Incandescent Bulb: Qnuru's Prism LED bulbs are designed to address the demand for energy efficient, non-toxic alternatives to today's incandescent



bulbs, which are only 10% efficient, wasting 90% of their energy to heat dissipation. Incandescent bulbs in the U.S. will be phased out beginning in 2012 because of a government mandate that all general-purpose light bulbs become 30% more energy efficient than current incandescent bulbs.

The centerpieces of Qnuru's Prism product line are its A Series 60W replacement LED bulbs that come in two models: Opal A19 and Topaz A19. The highest performance 60W equivalent screw-in LED bulb available, Qnuru's Opal A19 provides an output ranging from 590-630 lumens while using only 9 watts of energy. The Qnuru Topaz A19 LED bulb provides an output range of 420-520 lumens while consuming only 6 watts of energy. Both products come in a variety of color ranges and with dimming capabilities.

"Over the last three years we have developed the lighting industry's highest performance LED solutions with our Vector 75-1500 watt retrofit product line," commented Rhonda Dibachi, President and CEO of Qnuru. "It was a logical step to migrate our industrial-strength LED know-how to our Prism line of low wattage, consumer-ready LED bulbs. No other lighting company offers LED lighting solutions that span from 6 to 1,500 watts and 100 to 30,000 lumens. Whether you are a car dealership with 1,000 watt metal halide lights or a homeowner looking to replace a 60 watt bulb, we have the right size LED solution." ■

## LEDnovation Sets Landmark with 100lm/W Warm White LED A19 Replacement Lamp

LEDnovation, a leading innovator in LED lighting and replacement lamp technology, announced the introduction of the industry's highest efficiency and first high-quality 100 lumen/watt, warm white, dimmable A19-type replacement lamp. The first in the series of EnhanceLite® A19 Generation-2 LED lamps, the LEDH-A19-60-1-27D-I offers a 615-lumen output at a warm 2700K color temperature, delivering "on-the-target" light levels equivalent to a 60-watt standard incandescent or 13-watt compact fluorescent in standard downlight applications.



**LEDnovation's EnhanceLite® A19 Generation-2 LED lamps, the LEDH-A19-60-1-27D-I, offers a 615-lumen output at a warm 2700K color temperature**

### Main Features:

- 615 lumen output with only 6.15 W power consumption
- Efficacy exceeding 100 lumens/watt verified at NIST accredited third party lab
- 90% energy savings compared to a 60-watt Incandescent
- 53% energy savings compared to a 13-watt CFL, without harmful mercury
- 2700K dimmable warm white with CRI greater than 90
- Designed for downlight and recessed fixtures

According to Israel J. Morejon, CEO of LEDnovation, "Our milestone achievement of 100 lumens/watt represents the promise of LED lighting as the highest efficiency lamp-level light source. We continue to invent, commercialize and deliver LED lighting innovations that aim to make energy-inefficient light bulbs obsolete. LEDnovation has conscientiously applied LED technology, power management expertise, and our proprietary color mixing technology, including deeper red saturation, to achieve this precedent-setting level of quality and performance.

This EnhanceLite® A19 Generation-2 lamp further expands the Tampa, Florida based company's full portfolio of LED-based replacement lamps, including the recently introduced line of industry-leading PAR and MR16 replacement lamps. LED lighting continues to gain acceptance for a growing number of applications by providing superior performance, higher efficiency and longer

lifetimes. Directional applications, such as those currently served by incandescent, PAR, and reflector lamps and which have seen relatively little acceptance of CFL solutions, are providing the newest solid business case for LEDbased replacement lamps.

All LEDnovation lamp models are tested for photometric performance in accredited third-party labs according to IES LM-79 requirements, with reports available online. All lamps meet UL 1993, UL 8750 and CSA 84 safety standards. These commercial grade models are rated for a 50,000-hour lifetime and carry an industry-leading 5-year warranty. The EnhanceLite® LEDH-A19-60-1-27D-I was starting production and shipping in mid December 2010. ■

## Edison Opto Unveiled New Light Source at the LED EXPO 2010 in New Delhi

Edison Opto showed a whole new lighting source which focuses on bulbs and commercial application. For a long time Edison has been making efforts to develop T.E.M.O. (Thermal management, Electrical scheme, Mechanical refinement, and Optical optimization) as its R&D capacity. LDMS (Lighting Design Manufacturing Service) is an integrated program derived from the T.E.M.O. in providing customers various LED components and modules to meet their needs.

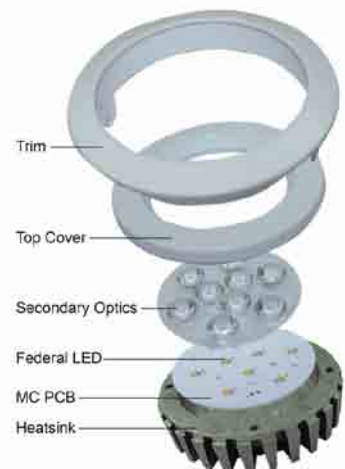

**Edison Opto's new lighting source focuses on bulbs and commercial application**

The new lighting source (as shown) includes the latest EdiPower II ® which can reach up to 120lm/W, Edixeon® series with light

# Powering the lighting revolution

**LightLine.** The next generation of constant current AC input and DC input LED drivers

## ✓ High Power AC input LED Driver

The RACD60 series - a high power AC input LED driver module. Designed to meet the requirements of the newest and brightest LEDs on the market. Output current from 700mA up to 4.2A, this series can drive almost any LED in the market. One of the smallest 60Watt AC LED driver in the industry.

## ✓ Low Power AC input LED Driver

Introducing the RACD series low power AC input LED driver. A low cost solution to the low power Solid State Lighting. This family includes of 3W, 6W, 12W and 20W modules with different configurations capable of driving up to 15 high brightness LEDs.

## ✓ DC input LED Driver

The RCD-24 family offers DC input LED driver modules with constant current output from 300mA up to 1.2A, high efficiency (up to 97%), wide input voltage range (5~36Vin), very low output dropout voltage, 2 independent dimming options (PWM and 0-10 analog) and a long lifetime up to 600,000 hrs.



**RECOM**

[www.recom-electronic.com](http://www.recom-electronic.com)

efficiency of 130lm/W, and Federal series of 100lm/w. Edison Opto stresses the core integrated technology. The high-efficiency components with secondary lens, heat sinks, and power circuits can be used widely in commercial lighting, indoor lighting and outdoor lighting with the result of satisfying the demand of the growing market in India.

With India's rapid urbanization and industrialization, a large number surges in the requirement for electricity and lighting loads 12%. That is why energy-saving LED lighting, the replacement of traditional lighting, is needed urgently. The Grameen Surya Bijli Foundation indicates that the 2009 output value in lighting is only 4,900 million USD that increased 3.1% compared to the previous year. The annual growth rate in 2015 will reach 41.5%. In addition, a survey shows Indian import demand for lighting products at more than 5,000 million U.S. dollars and it is continually increasing. Accelerating the development and distribution for the huge business opportunities in the Indian market, Edison unveils a series of new active lighting sources. According to different areas Edison responds to customer applications by showing comprehensive product capabilities and strengthening international awareness in the high-power LED market. ■

## Fairchild Semiconductor's PFC/PWM Controller for Dual-Switch Flyback Topologies

Power engineers, especially those involved in All-In-One (AIO) PC power, Slim Pack PC adapters, LCD TV and LED lighting designs, require a dual switch flyback topology that provides the higher efficiency and increased energy savings required by government regulations – something that LLC or single flyback solutions cannot provide. Developed to answer this need, Fairchild Semiconductor's (NYSE: FCS) FAN6920MR, an integrated critical mode PFC and quasi-resonant current mode PWM controller, meets regulatory requirements by providing >90 percent efficiency and <300mW at no load for increased power savings.

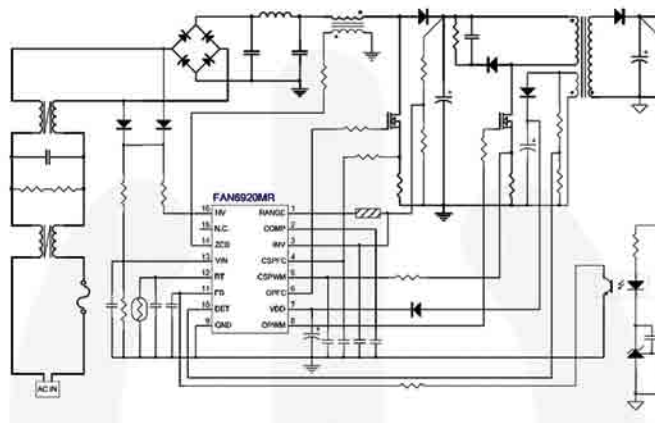

**Application diagram of the FAN6920MR that offers integrated critical-mode and quasi-resonant current-mode flyback PWM controller design**

### Key Specifications:

- Integrated PFC and Flyback Controller
- Critical-Mode PFC Controller
- Zero-Current Detection for PFC Stage
- Quasi-Resonant Operation for PWM Stage
- Int. Minimum  $t_{OFF}$  5 $\mu$ s for QR PWM Stage
- Internal 5ms Soft-Start for PWM
- Brownout Protection
- High /Low Line Over-Power Compensation
- Auto-Recovery Over-Current Protection
- Auto-Recovery Open-Loop Protection
- Externally Auto-Recovery Triggering
- Adjustable Over-Temperature Latched
- VDD Pin and Output Voltage OVP (Auto-Recovery)
- Internal Temperature Shutdown (140°C)

The FAN6920MR combines a power factor correction (PFC) controller and a quasi-resonant PWM controller for a cost effective design that uses fewer external components. For PFC, the device uses a controlled on-time technique to provide a regulated DC output voltage and to perform natural power factor correction. With an innovative total harmonic distortion (THD) optimizer, the FAN6920MR can reduce input current distortion at zero-crossing duration to improve THD performance.

For PWM control, the FAN6920MR provides several functions to enhance the power system performance including extended valley detect up to the 12th valley cycle for reduced switching frequency, improved light load efficiency, green-mode operation, an internal 10ms soft start and high/low line over-power compensation.

Additionally, the device provides many protection functions including brownout, secondary-side open-loop and over-current with auto-recovery, external auto-recovery protection triggering and internal over-temperature shutdown.

Fairchild enables engineers to drive innovation in their designs by developing solutions like the FAN6920MR, which is part of a family of integrated critical mode PFC and quasi-resonant current mode PWM controllers. These devices integrate functionality, increase performance and provide full protection while lowering component counts, simplifying design and reducing bill of material costs. ■

## DC/DC LED Driver with Wide Input Range

With the release of AMLD-Z, Aimtec launches the third series in its line of DC/DC LED Drivers. Offered in a DIP24 package, the AMLD-Z are feature rich LED drivers that meet the rigorous demands for environment friendly LED lighting solutions.



**Aimtec's AMLD-Z series DC/DC LED driver deliver up to 1000mA output current, an input range of 8:1, while providing 97% efficiency**

From a wide (8:1) input range of 7-60VDC, the AMLD-Z series of LED drivers provide constant output currents ranging from 150mA to 1000mA, generating from 6 watts to 48watts of power to maintain the constant color and brightness that is required by today's most demanding LED applications.

Feature rich, the AMLD-Z series provides remote ON/OFF control function in addition to both PWM and analog voltage dimming



control (0 – 100%). Open and short circuit protection works continuously until the short circuit condition is resolved, protecting the converter, the LED lights, and the converter's input circuit from extremely high currents a short to ground causes.

Boasting efficiencies as high as 97%, Aimtec's LED drivers are designed to be as reliable as the LEDs they drive, allowing them to be used at an operating temperature of -40°C to +85°C at full load for compatible with a wide range of LEDs applications from a variety of manufacturers without the need for any external components.

RoHS compliant, the AMLD-Z series of LED drivers is competitively priced starting at \$14.26/1000+pcs with samples available from stock and can be ordered through one of Aimtec's franchised distributors. ■

## Diodes Linear Constant Current Driver Provides Versatile Control for LED Applications

Diodes Incorporated, a leading global manufacturer and supplier of high-quality application specific standard products within the broad discrete, logic and analog semiconductor markets, introduced the AL8400 linear LED driver controller. The AL8400 is designed to tightly regulate LED current via an external transistor across wide variations of high brightness LEDs. Suiting a broad range of LED chains in illumination, indication or signage systems, the controller can directly operate from 2.2V to 18V and will drive either N-channel MOSFET or NPN Bipolar transistors.

### Features:

- Low reference voltage (VFB = 0.2V)
- -40 to 125°C temperature range
- 3% Reference voltage tolerance at 25°C
- Low temperature drift
- 0.2V to 18V open-collector output
- High power supply rejection (> 45dB at 300kHz)

### Applications:

- Isolated offline LED converter
- Linear LED driver
- LED signs
- Instrumentation illumination

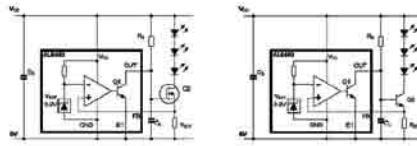

**Diodes' AL8400 LED driver application circuits using MOSFET (left) and Bipolar transistors (right)**

The AL8400 has a very low 200mV current sense voltage which reduces operating voltage overhead and increases efficiency compared with traditional solutions. Its open collector output drives the external pass transistor allowing it to regulate LED current from tens of mA to above an A.

Using an external pass transistor allows power dissipation and maximum drive capability to be optimized. Longer LED chains needing significantly more than 18V can be driven with minimal additional external components.

The LED driver's low temperature drift and 3% reference voltage at 25°C outperforms most existing linear solutions while keeping system costs down at the same time. The AL8400 linear controller in its small footprint, low profile SOT353 package, delivers power density that is superior to many common package alternatives and provides a low EMI solution. ■

## Renesas Electronics Introduces R2A20134 LED Driver IC for LED Lighting

Renesas Electronics, a premier provider of advanced semiconductor solutions, announced the availability of its R2A20134 LED driver IC that supports LED lighting applications with high efficiency and a high power factor at low cost.

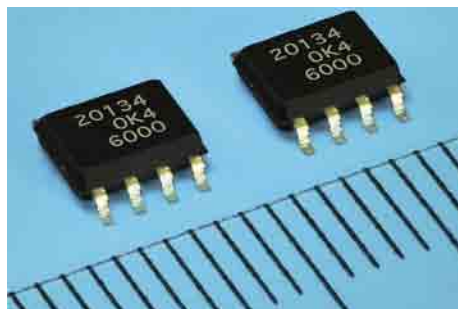

**Renesas' R2A20134 LED driver IC provides high efficiency and high power factor**

The market scale of the LED lighting field is expected to grow substantially, spurred mainly by the adoption of LED lighting as a replacement for incandescent light bulbs. Since LEDs use direct current drive, it is necessary to convert the commercial alternating current (AC) power supply to direct current (DC). This requirement to add AC-DC conversion circuits has brought to the fore, a demand for elements designed to address issues such as cost, conversion efficiency, and power factor. In response, a variety of control methods for LED lighting drivers have been announced. Using exclusive voltage step-down control technology, Renesas Electronics has succeeded in developing an LED driver IC that delivers high efficiency and a high power factor at low cost.

### Main Features:

- Reduced system cost  
Renesas Electronics' exclusive voltage step-down control technology (single-stage) provides a high line-to-ground voltage. In addition, the ability to select low-voltage MOSFETs (voltage tolerance of only 500 volts (V) to 300 V, rather than the typical 700 V) further contributes to lower system cost.
- High efficiency and a high power factor  
The use of Renesas Electronics' exclusive high-voltage control and critical-conduction mode enable zero-current switching at turn-on and switching in a low drain-source voltage state. As a result, the new LED driver IC enables reduction of power loss during switching and achieves the industry-leading power factor of 92 percent by reducing the power loss during switching. In addition, critical-conduction mode allows PFC (power factor correction) control using few external components and realizes a power factor of 0.9 or higher.
- Support for various LED control modes  
A variety of control modes can be achieved by changing the configuration of the externally connected elements. Examples include buck-boost control, average-current control, peak-current control, and constant-input-power control. Renesas Electronics' R2A20134 LED driver IC also can be employed in TRIAC dimmer applications by applying a voltage matched to the TRIAC phase to the FB (feedback) pin for constant-current control. The company additionally supplies drive MOSFETs meeting a variety of power and performance requirements. ■

## National Semiconductor Introduces LED Driver with Extraordinary Phase-Based Dimming Capabilities

National Semiconductor Corp. introduced a new LED driver with the industry's best phase-based dimming performance for high-brightness light-emitting diode (LED) applications. The LM3450 LED driver integrates active power factor correction (PFC) and phase dimming decoding to provide uniform, flicker-free illumination across a wide, programmable dimming range. This member of National's PowerWise energy-efficient product family is well-suited for use in high-performance, phase dimmable, 10 Watt to 100 Watt LED fixtures.

Residential and commercial lighting applications that interface with phase-based dimmers require circuitry that can correctly decode a phase-chopped waveform to provide proper dimming of the LEDs. Dimmable LED drivers available today do not always meet the minimum current requirement for forward phase or TRIAC-based dimmers, causing the dimmer to shut off or "misfire" during operation. This causes inaccurate decoding of the phase angle resulting in flicker, particularly at very low dimming levels. To compensate, today's drivers reduce the LED dimming range or continuously burn power to keep the dimmer from misfiring.

National Semiconductor has taken a unique approach to solving this issue with its new LM3450 LED driver that integrates hold circuitry to dynamically adjust the current through the phase dimmer. The dynamic hold circuitry, coupled with a programmable,

intelligent dimming decoder, ensures smooth, consistent illumination across the full dimming range. This combination of features provides the most efficient and uniform dimming performance in the industry. The LM3450 LED driver also provides active power factor correction, ensuring a high power factor that complies with residential and commercial Energy Star standards.

The LM3450 LED driver regulates an accurate output while maintaining excellent power factor at the input. The integrated phase dimming decoder interprets the phase angle and remaps it to a 500 Hz PWM output to dim the LEDs. This combination of features is ideal for implementing a phase dimmable off-line LED driver for 10 Watt to 100 Watt loads.

### Technical Features:

- Critical conduction mode PFC
- Over-voltage protection
- Feedback short circuit protection
- 70:1 PWM decoded from phase dimmer
- Analog dimming
- Programmable dimming range
- Digital angle and dimmer detection
- Dynamic holding current
- Smooth dimming transitions
- Low power operation
- Start-up pre-regulator bias
- Precision voltage reference

### Applications:

- Dimmable downlights, troffers, and lowbay
- Indoor and outdoor area SSL
- Power supply PFC

Other benefits include an analog adjust input to allow for differentiation such as thermal foldback, interface to sensors or dimmer range adjustability. The LM3450 can be implemented in either single stage or two stage configurations. ■

## Sharp Controller for Indoor Lighting- Adjusts Brightness and Color

Sharp Corporation has developed and will introduce the LR56001 LED controller for LED ceiling lights, allowing users to adjust the brightness and color of three types of LEDs: cool white, warm white and night light.

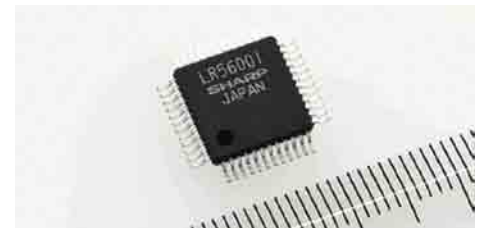

Sharp's LR56001 IC is a three channel LED controller for indoor lighting

### Major Features:

- A three-channel independent control allows brightness and color adjustments to be made for three types of LED ceiling lights (cool white, warm white, and night lights).
- Built-in chopper circuit contributes to greater energy efficiency for LED lights.

The demand of long-life, energy-saving LED lighting is growing and its use is expected to expand for indoor lighting fixtures, such as ceiling lights and light bulbs.

### Specifications:

Product	LED controller for indoor lighting
Model name	LR56001
Output channels	3
Operating voltage	Core: 5.0 V ± 0.5 I/O: 3.3 V ± 0.3 / 5.0 V ± 0.5
Consumption current	TYP. 12 mA
Operating temperature	-40 °C to 85 °C

The LR56001 LED controller can independently control up to three types of LED lights. This allows the user to choose among three types of ceiling lights—cool white, warm white and night light—with each at the desired level of brightness. That allows the user to change the color emitted, from a warm red color to a cool light blue color. Further, the built-in chopper circuit prevents power loss even when the forward voltage of the three types of LED differs. ■

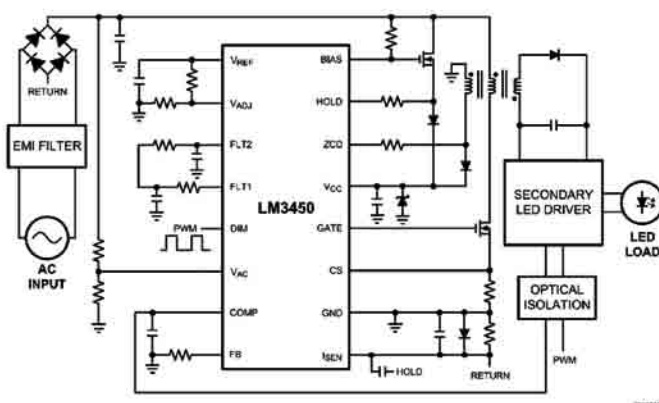

A typical application circuit using the LM3450

## TI Introduces New LED Lighting Controller with Power Factor Correction

Texas Instruments Incorporated introduced a new single-stage LED lighting pulse width modulation (PWM) controller. The TRIAC-dimmable solution regulates LED current and also achieves near unity power factor. The reference design can achieve 85 percent efficiency, which enables high-density, small form factor designs. The TPS92210 is designed for general lighting applications, such as commercial and residential recessed, troffer, light bulb replacement, architectural and display lighting.

### Key features and benefits of the TPS92210:

- TPS92210 features flexible operation modes such as peak primary current, constant on-time and frequency modulation. The constant on-time mode provides single-stage power factor correction for improved efficiency.
- TPS92210's cascoded MOSFET configuration results in 10 percent lower switching losses with fast and easy high-voltage start-up compared to competitive devices.
- Continuous linear TRIAC dimming provides flicker-free, uniform control.
- Multiple protection features, such as over voltage protection without optocouplers, thermal shutdown and advanced over current, safely shut down the system if fault conditions exist.
- Programmable fault response, full shutdown and shutdown restart provide added flexibility for fault response.

### Availability and pricing:

The TPS92210 is available now in an 8-pin SOIC package and is priced at \$0.70 in quantities of 1,000. ■

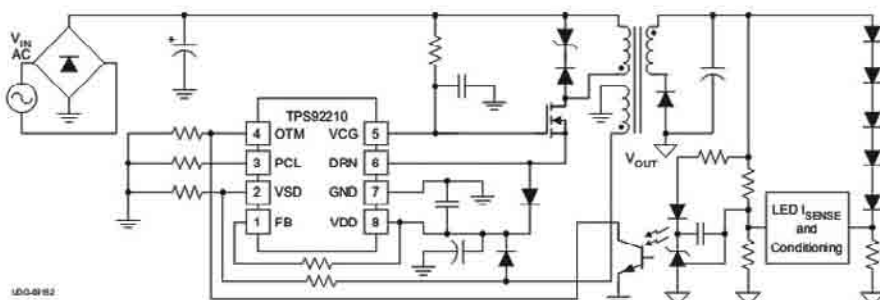

Functional diagram using TI's new TPS92210 LED driver

## Allegro MicroSystems Introduces High Performance Fault Tolerant LED Driver

Allegro MicroSystems, Inc. introduces a new multi-output white LED driver for LCD backlighting in consumer and industrial displays. Allegro's new A8515 device has advanced protection features to provide optimized viewing. It integrates a current-mode boost converter with internal power switch and two current sinks.



The new Allegro A8515GLPTR-T is ideal for driving long LED strings

The boost converter can drive up to 24 LEDs at 120 mA. The two LED current sinks can also be paralleled together to achieve LED currents up to 240 mA. This new device can operate from a single power supply from 5 V to 40 V. The low 720 mV regulation voltage on LED current sources reduces power loss and improves efficiency. A comprehensive fault table is included in the datasheet to describe the leading-edge performance and protection features of the A8515. It also integrates a driver for an (optional) external input disconnect switch.

The A8515GLPTR-T is available in an eTSSOP-16 (LP) exposed pad package for advanced thermal performance. ■

## LED Driver from Supertex Delivers Superior Current Accuracy with Integrated MOSFET

Supertex, a recognized leader in high voltage analog and mixed signal integrated circuits (ICs), introduced HV9967, an open loop, average-mode current control LED driver IC that operates in a constant off-time mode. The IC includes a 60V, 0.8 ohm MOSFET that can be used as a stand-alone buck converter, or connected as a source driver output for driving an external MOSFET, such as Supertex DN2450, to operate at offline AC line voltages.

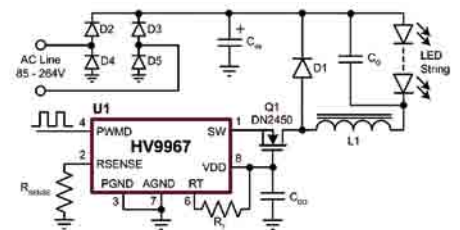

Typical application circuit using the Supertex HV9967 driver IC

### Features:

- 3% accurate LED current
- Integrated 60V 0.8Ω MOSFET
- Small outline MSOP-8 package
- Low sensitivity to external component variation
- Cascode connection with a 500V depletion-mode MOSFET
- Single resistor LED current setting
- Fixed off-time control
- PWM dimming input
- Output short circuit protection with skip mode
- Over-temperature protection

### Applications:

- DC/DC or AC/DC LED driver applications
- RGB backlighting of flat panel displays
- General purpose constant current source
- Signage and decorative LED lighting
- Chargers

The HV9967 features a proprietary control method that achieves fast, accurate LED current control through sensing only the switch current. The IC delivers LED current



accuracy of +/-3% without sensitivity to external component variation. It utilizes average-mode current control, which doesn't produce a peak-to-average error, and therefore greatly improves LED current accuracy and line and load regulation without requiring loop compensation or direct current sensing. The HV9967 also includes internal over-temperature and short circuit protection, and a PWM dimming input.

"With its unique current control method, HV9967 offers solid-state lighting designers the benefits of high current accuracy and consistency for extended LED lifetimes," states Hernan DeGuzman, Vice President of Marketing for Supertex. "This IC is quite simple to use, and its accuracy is virtually insensitive to the tolerances of external passive components in the application circuit."

The HV9967 is available in an 8-lead MSOP package. The part is Green and RoHS compliant. Samples are available from stock. Lead-time for production quantities is 4-6 weeks ARO. Pricing is US\$.80 each for the HV9967MG-G in 1K quantities. ■

## 100W Low Profile PCB-mountable Power Supplies from TDK-Lambda

Power supply expert TDK-Lambda UK has upped the output power of its ZPSA series of compact PCB-mountable AC-DC power supplies with the introduction of a 100W model. The new single-output ZPSA100 accepts a wide input voltage range, has a very low profile (26.6mm) and industry standard footprint (127 x 76.2mm), making it an ideal choice for applications such as LED signage and lighting, point-of-sale equipment, datacom, video/audio routers and test & measurement equipment.

Accepting a wide input voltage range of 90-264Vac (47-440Hz) or 120-370Vdc, the ZPSA100 series is ready for use globally with no further configuration or input selection. Its industry standard footprint makes it an ideal choice as a drop-in replacement for existing supplies, while its low profile means that it can be installed in the most compact of applications.



**TDK-Lambda's ZPSA100 series power supplies are compact with up to 90% efficiency**

TDK-Lambda's ZPSA100 series is approved to national and international safety approvals, including IEC/EN/UL/CSA60950-1 (edition 2) meets conducted and radiated EMC requirements of EN55022-B and FCC Class B (without additional filtering or components) and meets EN61000-4 immunity specifications for greater reliability. All models in the ZPSA100 series carry the CE mark, according to the LV Directive, and come with a two-year warranty. ■

## IST Launches iDrive® Force™ - World's First DSP Enabled, 24-Channel LED Driver

The latest addition to IST's portfolio of world-wide patented LED driver technology is the iDrive® Force 24™, the world's first DSP enabled, 24-channel LED driver, which is a multiple channel solution for 19" rack-mounted server cabinets. Designed specifically with the entertainment and architectural lighting industries in mind, the Force 24™ is currently proving just as popular for white light dimming applications, due to its ability to mimic tungsten dimming on DMX.

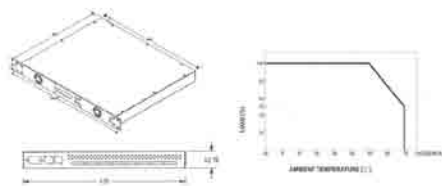

**IST's iDrive® Force 24™ packs a punch with a 672W output across 24 channels in a small 19",1U package**

### Features:

- 19 inch rack mounted driver system – 1U
- Up to 672W output power
- 384 LEDs across 24 Independent Channels
- Patented Dynamic Power Control and Pulse Amplitude Modulation
- Backlit 16x2 LCD display menu system
- 100mA to 1A LED forward current per Channel in 50mA steps
- 8-bit master channel current resolution to prove up to 4 billion colors in 3 Channels
- Wide output DC voltage range (1V to 48V)
- DMX or RDM protocol support
- Multiple channel bonding to create high current outputs >6A
- 8 individual temperature measurement sensor inputs for dynamic lighting fixture protection
- Configures as 8 outputs of 3 channels or 6 outputs of 4 channels
- 672W solution can drive up to 1000mA per channel; either 12 channels @ 48VDC or 24 channels @ 24VDC.
- Real Time LED current & voltage monitoring
- Over 81,000 internal program scene options
- DMX Master/Slave options
- Linear & Gamma corrected dimming selected on each channel

The iDrive® Force 24™ packs a punch with a 672W output across 24 channels in a small 19",1U package. It was surprising to find that alternative products available today are twice the size, or offer only half the output power. The channels are bondable, allowing multiple channels to be wired together to deliver a higher amp output. The Force 24™ offers 8 bit resolution as standard but provides up to 16 bits with a further 256 step master dimming channel and is fully DMX512A and ANSI E1.20-2006 RDM compliant.

The exclusion of electrolytic capacitors on the LED output stages serves to prolong the life of the driver, avoiding one of the major reasons behind LED driver failures. In addition, the multiple channels enable faster programming of the rack-mounted drivers, which in turn reduces installation times.

At the core of the Force 24™ is the latest Texas Instruments 32-bit Digital Signal Processor with high performance integrated peripherals designed for real-time control applications. The eco-DSP™ platform enables the installer to program each channel for LED currents from 100mA up to 1A per channel in 50mA steps and Vf voltages from 1V up to 48V.

Matt Fitzpatrick at IST enthused: "The iDrive® Force 24™ is the first LED driver to utilize our new eco-DSP™ platform so users will be able to benefit from a highly robust and energy efficient driver. The eco-DSP™ platform enables common anode connected LED fixtures to be used as well as allowing more than one channel to be bonded together to get forward currents up to 8A. It is the most flexible LED driver platform I have seen since I joined the LED industry 10 years ago".

The next highly anticipated addition to the Force 24™ family will be an incandescent light bulb dimming version, UltraDim, which is capable of removing visible DMX steps dynamically in real-time. ■

## Introduction DecaLED Touch Panel DMX 4

The DecaLED® Touch Panel DMX 4 is a compact LED controller with DMX512 and PWM outputs. The stylish design in glossy black polycarbonate can easily be built into a wall socket. The panel has no buttons but it is pressure sensitive. The device has a user friendly design.



**The DecaLED® Touch Panel DMX 4 LED controller offers both DMX512 and PWM outputs**

**This panel includes the following features:**

- Static color, configured by means of a handy swivel function. 4 color settings can be stored in memory.
- Choose from 10 preset color loops, for which the transition speed and intensity can be adjusted. 4 preferences can be stored.
- Usable as DMX controller.
- When using an external 12V or 24V DC power supply, for example, led strips directly connected to the PWM output.
- Dimming of your choice (0 ~ 4 seconds) for on and off.
- Use up to 2A per channel, in total suited for a maximum of 6A.
- Visible indication of the current RGB color on the front of the panel.

The DecaLED® Touch Panel DMX 4 is ideal for small stand-alone installations where 12V or 24V DC LED products are used, such as DecaLED® Flex RGB, DecaLED® Flex RGB HD and DecaLED® Cove Flex RGB. It is therefore an interesting product for i.e. interior designers, stand builders and restaurants, bars and hotel businesses. ■

## Kathod Showcased Series of Improved and New Optics for LED Lighting at electronica 2010

At electronica, Kathod showed up with an extended portfolio of LED optics: ZETALENS, realized in round and square shapes; STRIPLENS, specific for a new LED mounting concept; TRIPLE and QUAD MINI LENS; ROUND REFLECTORS; and the DARK LENS, a first-of-its-kind anti-glare reflector.

**ZETALENS** - The continuous evolution of LED technology has resulted in a reduction of LED dimensions and size, and an increase in luminous output. Zetalens, realized in NJC technology, allows for the housing of 7 LEDs and is available in narrow, medium and wide Beams. Its shape and dimensions, available in 4 different configurations, offers designers as well as the final user the freedom to choose among 12 models. The result is a very diverse lens family that can be used in a variety of applications.

**ROUND REFLECTORS** - The request of high efficiency in Lighting along with the utmost necessity of energy conservation, have made the Power LED applications an ever-increasing requirement in the lighting Industry. Many of these new applications require

placement of LEDs in narrow or recessed spaces, as well as in diverse LED configurations never considered before. This evolution is not without difficulties because it requires the employment of new technologies while guaranteeing high efficiency and superior performances.

**Round Reflector Products:**

- KCLP17CR (Metallized Version), 17.55 mm Diam; 10.71 mm Height, Narrow Beam
- KCLP20CR (Metallized Version), 20.45 mm Diam; 10.71 mm Height, Narrow Beam
- KCLP17ST (Embossed Version), 17.55 mm Diam; 10.71 mm Height, Medium Beam
- KCLP20ST (Embossed Version), 20.45 mm Diam; 10.71 mm Height, Medium Beam

**Common Features:**

- High efficiency
- Available in 2 different beams
- Ø 17mm and Ø 20mm Standard
- Typical applications: Portable lighting, Lamps, Architectural lighting
- Most applications where a compact light source is required

**NEW MULTI LENSES** - Kathod unveils the most comprehensive range of MULTI LENSES specific for multichip MINI POWER LEDs. Dedicated to the most demanding applications in Lighting Design, the Series include one of the most expected lenses on the market PL350ANK TRIPLE LENS, a 50.02mm Diameter Triple Lens, specific for Mini LED applications requiring this size.

**MINI LENSES** is dedicated to the new generation of MINI POWER LEDs. The MINI LENSES, created with the proven NJC technology, are superior, technologically advanced products that meet and exceed the most demanding requirements of the market. Mini Single Lenses are the new generation of optics for superior lensing for your projects. ■



**Kathod's well established and new products at electronica 2010 (from top/left to bottom/right): Round Reflector - metallized versions, Round Reflectors - embossed versions, the Dark Lens, Triple Minilens, Zetalens - round, Zetalens - square, and Colour Mixing Lenses**

## MAZeT New Products Highlighting MMCS6 Multiple-Color-Sensor

With the principle of a multiple color sensor, MAZeT is pursuing a strategy that bridges the gap between the three-range sensors and spectral measurement devices for sensor applications. The integrated TIAM4 multiple color sensors module, contains the entire sensor electronics on-chip, in addition to the spectral operating detector. The new MDDC 4-channel sensor signal amplifier for sensors with current output is suitable for fast applications in conjunction with detectors and arrays, such as In-Line (Color) Measurement and control in automated processes. Finally, MAZeT also offers a tool for simulating compact spectrally-selective semiconductor sensors for accurate in-line measurements.

**JENCOLOR - Multiple Color Sensors for Accurate and Fast In-Line Color Measurement**  
The multiple color sensor bridges the gap between the three-range sensors and spectral measurement devices for sensor applications.

The new **MMCS6** product family is based on the proven technologies of the compact and price-to-performance ratio-optimized semiconductor sensors with integrated interference filters. With the MMCS6, a color measurement with seven spectral characteristics in the range of 380 to 780 nm can be taken on the basis of spectral estimation.

The evaluation of a color in this sensor is based not on the colorimetric but on the radiometric level. The initial result is not the chromaticity coordinate but the spectrum of a color, which can be then used to calculate the chromaticity coordinate. The advantages of such measurements lie in the much higher information density in terms of color measurement.

The MMCS6 sensor confers the advantage that the recognition and measurement of metamerism effects can be filtered out, which cannot be done with RGB or XYZ sensors. Metamerism in the optical sense means various spectra that for a defined type of light produce the same impression on the human eye.

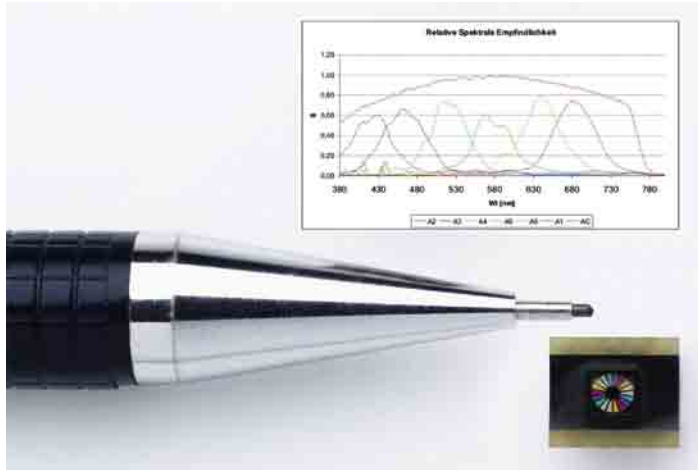

The **MMCS6** product family offers accurate measurement options with seven spectral characteristics in the range of 380-780 nm

The spectral characteristics of the MMCS sensors are arranged in such a way that their border areas overlap. It follows that only as few gaps as possible exist in the visible spectrum. Misleading interpretation of the colors is thus minimized and the measurement accuracy increased. The sensor operates largely independent of the quality of the light sources. Through the spectral approximation of the measured color using MMCS sensors, color differences to which the human eye does not respond can be determined even there.

**TIAM4 Multiple Color Sensors On-Chip** - A new member of the multiple color sensors is the so-called integrated TIAM4 module. In addition to the spectral operating detector, it contains the entire sensor electronics on-chip. The photocurrents of the detector are converted into voltages and are available via S & H on a MUX on the output side as an analog voltage signal for digital conversion. The TIA-based amplifier is individually programmable in transimpedance over eight levels and is characterized by a very good linearity in the amplifier stages and by low noise.

The new Multi-Channel Amplifier IC, **MDDC** 4-channel sensor signal amplifier, for sensors with current output converts small input currents quickly and across a high bandwidth and dynamic range and digitizes them on chip via a transimpedance amplifier. Transimpedance amplifiers are preferred in industrial measurement technology for their rapid and cyclic conversion and amplification of the very small currents used in optoelectronic sensors. The ASIC is suitable for fast applications in conjunction with detectors and arrays, such as In-Line (Color) Measurement and control in automated processes, such as printing and analysis.

**Simulation Tool** for Color Measurement Tasks and Regulation of RGBxx LEDs - MAZeT offers a tool for simulating compact spectrally-selective semiconductor sensors for accurate in-line measurements. The system is simulated with the tool starting with the feasibility study and is optimized according to the requirements. Both the selection of the correct sensor and the optimum composition of filters and lighting are achieved in advance with the simulation software to enable the best possible quality for the actual measurement. ■

## Industry's First Multidirectional Mini Blower

Providing a unique solution for customized air-flow applications, JARO's new JRB2235 series rotates at 8500 RPM's and produces a powerful 1.2 CFM of super-cooled air (with a static pressure of 0.122" of H<sub>2</sub>O). Operating voltage is 4.0 V to 5.5 VDC. The availability of single or dual unit configurations provides customers with the unique ability to select the precise direction(s) of airflow, making this the first multidirectional mini blower in the Thermal Cooling Industry.



JARO's new JRB2235 series mini blowers are one of the most compact blowers on the market



These new subminiature blowers are conveniently designed for small applications (22x26x35 mm). Applications include: LEDs, pocket projectors, MID/UMPC/Smartbooks, CCTV, GPS, fuel cells, portable gas/particulate detectors, portable plasma generators, ventilation and defrosting. According to Jaro Thermal's VP, Dennis Eisen, "The new blowers lead the industry in customizable, aimable air-flow products, while providing compact design, long life & high quality." ■

## New Products for Coating LED Assembled PCBs

To a growing extent, PCBs are assembled with LEDs and are thus partially visible when used in illuminants. In choosing your solder resist or conformal coating, you will therefore have to consider optical requirements, too.



**An optical adaptation to aluminum reflectors can be implemented by coating with the silver-grey 2-pack screen printing lacquer FP 2410-1020**

For optimizing the radiation characteristics of LEDs, white solder resists are particularly well-suited, such as the temperature-stable solder resist ELPEMER® SD 2491 SM-TSW-R2. This product stands for the new generation of purely white, opaque photoimageable solder resists which have maintained the high remission values as well as the outstanding thermal stability of their predecessor ELPEMER® SD 2491 SM-TSW-R1 and which, on top of this, can be processed more securely within immersion tin (Sn) and immersion gold (ENIG) methods.

An optical adaptation to aluminum reflectors can be implemented by coating with the silver-grey 2-pack screen printing lacquer FP 2410-1020. This product with the typical aluminum look is recommended for LED assembled boards in illuminants provided with

aluminum reflectors. The thermal-curing solder bath resistant screen printing lacquer FP 2410-1020 can be used on top of either white or green photoimageable solder resists.

A maximum light yield plus a reliable protection is ensured when selective-coating with white-opaque conformal coatings such as ELPEGUARD® SL 1397: All LEDs are spared during coating while dark components are covered, thus increasing the light yield (remission) distinctively. The ELPEGUARD® SL 1397 is characterized by extremely high remission values along with a high light and heat stability.

A striking contrast with the base material plus reliable protection can be achieved by the black-opaque, mat conformal coating ELPEGUARD® SL 1347. With this product, it is possible to selective-coat your assembled PCBs in black which are usually coated with green solder resist, in a way that a striking contrast of the LEDs with the non-reflecting base material is produced. This is of particular advantage in display applications such as panels, signaling lights etc. ■

## Labsphere Launches High Speed LED Characterization Spectrometers

Designed for a full range of LED characterization measurements, Labsphere (www.labsphere.com) has introduced the CDS-5400 and CDS-9800 High Speed LED Spectrometers. Both models offer reliability, speed and accuracy with a choice of spectral range to suit specification application needs.



**Labsphere's CDS-5400 and -9800 deliver spectroradiometric and photometric measurement for solid state lighting.**

The CDS spectrometers, when integrated into Labsphere's systems, measure critical spectral characteristics of LEDs including flux; intensity; chromaticity coordinates; dominant

peak, and centroid wavelengths; color temperature and rendering properties; and purity. To capture and organize data, DLL drivers are available to connect the spectrometers to proprietary QA, calibration and production software.

With a spectral range of 305-930 nm, the CDS-5400 is well suited for production line testing of high brightness LEDs. With a 2ms integration time, the CDS-5400 delivers the high speed required by these environments. For more high precision applications including fixed quantity UV and quantum efficiency measurement, the CDS-9800 has a wide dynamic range and four models covering the spectral range of 240-1100 nm. With low stray light, the highly accurate CDS-9800 is intended for demanding R&D environments where precision is critical and a wide variety of devices need to be tested. ■

## Essemtec Introduces New LED Manufacturing and Assembly Technologies Product

Essemtec announced that it highlighted Pantera-XV at the LED EXPO, that took place in New Delhi, India, from December 17-19, 2010. Pantera-XV is a highly versatile, Swiss-quality pick-and-place, suitable for LED, standard SMD placement and dispensing. High-quality dispensing valves from Vermes were also featured.



**Pantera-XV from Essemtec is a new affordable assembly and dispensing system**

Pantera-XV from Essemtec is an affordable, Swiss-quality assembly and dispensing system, designed for small and medium size series production. It can accurately pick and place SMD components and LEDs. It features fast optical component alignment systems for components from 0201 up to 50x50 mm. Pantera-XV and also can dispense glue, conductive glue or solder paste.

Pantera-XV is a highly flexible system that can be changed from one production to another without standstill. Feeders can be exchanged while the machine is producing and are recognized automatically. Furthermore, programming for placement and dispensing can be done on an external PC. Pantera-XV also features "Virtual View," which ensures the quality from the first PCB of a series.

Other highlights on Essemtec's booth include the micro jet dispensing valves from Vermes. Known for their accuracy, speed and flexibility, these valves can be cleaned easily and, therefore, are suited for different dispensing tasks. The repeatability and reliability makes Vermes dispensing valves the first choice for dispensing of the LED lens. ■

## Advanced LED C-Plane Sapphire Polishing Slurry Enable 50% reduced Polishing Time

PETER WOLTERS is introducing to the LED market a new polishing slurry that has demonstrated a 50% reduction in the time required to complete final polishing for flip chip or through substrate LED's. This development utilizes a combination of chemical and abrasive technologies to decrease the cost of ownership or the manufacturing cost of the LED when manufactured on C-plane sapphire. "As demonstrated by our testing, the time required to achieve a comparable final surface finish has been reduced by half in substrates of identical incoming quality", said David Suica, President of Peter Wolters of America, the PETER WOLTERS Competence Center for Sapphire Polishing.

The quality and clarity of the final polished surface is comparable with the utilization of colloidal silica, which is commonly utilized in the final polishing step.



**The new Peter Wolters slurry reaches the surface roughness endpoint in half the time compared to the standard colloidal silica slurry**

This quality slurry product is completely mixed and tested by the PETER WOLTERS in-house professional team of scientists and engineers to maintain the highest levels of consistency and quality. The premixed slurry is shipped in a concentrated form, which can be easily thinned to the proper point of use consistency by adding DI water. Handling and storage of this custom slurry does not require any exceptional processes or procedures beyond what is typical to common colloidal silica.

This new polishing slurry demonstrates again that PETER WOLTERS has become well established as a market-leader for spares and accessory products which have undergone years of laboratory and field testing to ensure they meet the most exacting standards, with proven consistent and dependable results. ■

## Monocrystal Introduces 10-inch Sapphire Substrate to Expand LED Industry Prospects

Monocrystal, a leading manufacturer of electronic materials for LED and solar industries, announced the availability of the company's innovative ultra-large 10-inch C-plane epi-ready sapphire substrate.

The LED industry continues shifting to larger diameter substrates as it strives to achieve higher cost savings and to increase production throughput of quality LED chips to bring LED lighting closer to its widespread use.

Driven by its strong commitment to technology innovation for sustainability, Monocrystal continues developing next generation large-diameter sapphire wafer technology.



**An ultra-large 10-inch C-plane epi-ready sapphire substrate from Monocrystal is now available**

"We were ahead of competition with our best in class 8-inch sapphire substrates for LED and RFIC applications. Now, the introduction of innovative 10-inch LED sapphire substrates clearly demonstrates that Monocrystal is well positioned to support the growing market demands and expands LED industry prospects. This further strengthens Monocrystal position of technology and industry leader," said Oleg Kachalov, CEO of the company.

Today, sapphire substrates are used for more than 90% of GaN LED chips produced by the industry, including high-brightness devices used for LED lighting products. Compared with conventional incandescent lamps, LED consumes up to 90% less energy, and its life spans 50 times longer. Due to their unique features, LEDs also have become increasingly adopted in other applications, such as mobile devices, displays, traffic lights, car lighting and interiors. ■

## Breault Research Releases New Version of ASAP®

Breault Research Organization (BRO) has released a new version of the company's Advanced Systems Analysis Program (ASAP®). The ASAP 2010 V1R1 release includes new features and enhancements to the most sophisticated program for virtual prototyping of optical systems and devices. New features and enhancements in ASAP 2010 V1R1 include additional library resources, enhancements to the BRO Digitizer and REMOTE features, biaxial birefringence modeling, support for the import and export of new photometric data formats, updated CAD interoperability, as well as other software repairs and enhancements.

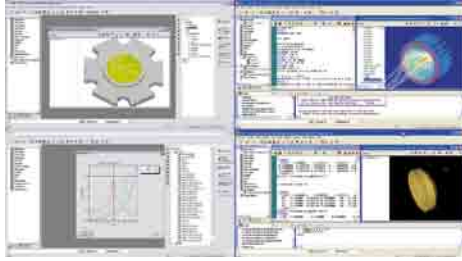

**Screenshots of the enhanced opportunities; Light Source Library Additions, Photometric Data Transfer, Scatter Model Library Additions, and ASAP/CATIA Interoperability**

#### ASAP 2010 V1R1 Highlights:

- Light Source Library Additions - Over 40 new models, including Luxeon, OSRAM, Philips, and Bridgelux sources.
- Scatter Model Library Additions - New Alanod MIRO, MoldTech, Tenibac, and other material models.
- Enhanced BRO Digitizer - Automatically find the data curve(s) on a graph using the enhanced BRO Digitizer.
- Enhanced REMOTE - Better file handling, access from scripting, and new tools for summing and averaging results.
- Photometric Data Transfer - Import and export files in the EULUMDAT and IES LM-63-02 photometric data formats.
- ASAP / CATIA Interoperability - Open native files from the CATIA® V5 r13 through r20 releases (optional add-on).
- Biaxial Birefringence - Model materials with biaxial birefringent properties such as thin-film coatings.
- Other Enhancements - Dozens of other command enhancements and customer-requested changes.

According to BRO's VP of Software Development, Dr. Kyle Ferrio, "The latest release of ASAP delivers customer-requested tools to enhance productivity and reach applications beyond any previously available commercial software. These are exciting times for optical engineers and scientists at the forefront of product design and innovation, and we are excited to support their success with this new release." ■

## Quantum Dots are not Dots

Researchers from the Quantum Photonics Group at DTU Fotonik in collaboration with the Niels Bohr Institute, University of Copenhagen surprise the scientific world with the discovery that light emission from solid-state photon emitters, the so-called quantum dots, is fundamentally different than hitherto believed. The new insight may find important applications as a way to improve efficiency of quantum information devices. Their findings were published on December 19<sup>th</sup> 2010 in the prestigious journal **Nature Physics**.

Today it is possible to fabricate and tailor highly efficient light sources that emit a single photon at a time, which constitutes the fundamental unit of light. Such emitters are referred to as quantum dots and consist of thousands of atoms. Despite the expectations reflected in this terminology, quantum dots cannot be described as point sources of light, which leads to the surprising conclusion: quantum dots are not dots!

This new insight was realized by experimentally recording photon emission from quantum dots positioned close to a metallic mirror. Point sources of light have the same properties whether or not they are flipped upside down, and this was expected to be the case for quantum dots as well. However, this fundamental symmetry was found to be violated in the experiments at DTU where a very pronounced dependence of the photon emission on the orientation of the quantum dots was observed.

The experimental findings are in excellent agreement with a new theory of light-matter interaction developed by DTU-researchers in collaboration with Anders S. Sørensen from the Niels Bohr Institute. The theory takes the spatial extent of quantum dots into account.

At the metal mirror surface, highly confined optical surface modes exist; the so-called plasmons. Plasmonics is a very active and promising research field, and the strong confinement of photons, available in plasmonics, may have applications for quantum information science or solar energy harvesting. The strong confinement of plasmons also implies that photon emission from quantum dots can be strongly altered, and that quantum dots can excite plasmons with very large probability. The present work

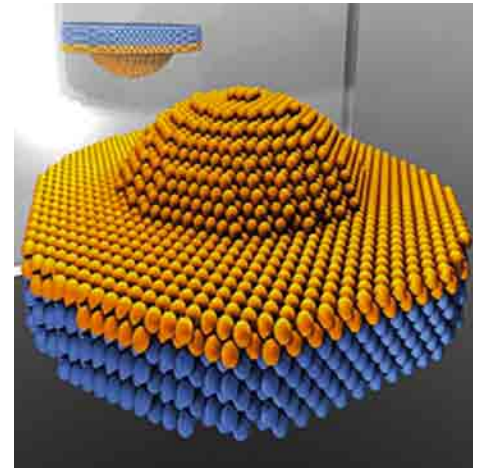

**Quantum dots are solid-state "artificial atoms" that are made up of thousands of atoms (yellow spheres) embedded in a semiconductor (blue spheres). Despite this complexity, the photon emission properties of quantum dots were hitherto believed to be like traditional atoms, where a point-emitter description is sufficient. Due to their mesoscopic dimensions, however, the point-emitter description is revealed to break down by comparing photon emission from quantum dots with opposite orientations relative to a metallic mirror**

demonstrates that the excitation of plasmons can be even more efficient than previously thought. Thus the fact that quantum dots are extended over areas much larger than atomic dimensions implies that they can interact more efficiently with plasmons.

The work may pave the way for new nanophotonic devices that exploit the spatial extent of quantum dots as a novel resource. The new effect is expected to be important also in other research areas than plasmonics, including photonic crystals, cavity quantum electrodynamics, and light harvesting.

#### The research group behind the discovery:

The research was conducted in the Quantum Photonics Group at DTU Fotonik, Technical University of Denmark by a research team consisting of postdocs Mads Lykke Andersen and Søren Stobbe and associate professor and group leader Peter Lodahl in collaboration with associate professor Anders S. Sørensen from the Niels Bohr Institute at the University of Copenhagen. ■





## ILD 4035 and ILD 4001 Step-down LED drivers for 1W and 3W+ LEDs



The new ILD 4035 and ILD 4001 from Infineon Technologies are part of a new LED driver family dedicated to general lighting applications.

- 40V input voltage
- 350mA LED current (ILD 4035)
- Up to 5A LED current with external MOSFET (ILD 4001)
- Overvoltage, overcurrent and thermal protection
- Small SC-74 package

To learn more about the LED driver portfolio for General Lighting, please visit [www.infineon.com/lowcostledrivers](http://www.infineon.com/lowcostledrivers)

The tiny controllers not only measure the intensity of the light falling on the workspace from the LEDs, but also identify how much light can come from different fixtures while separately measuring any ambient light coming in from the windows or spillover light from neighboring work areas. So if the sunlight from the window is sufficient to meet the user's needs for lighting, the overhead lights can dim or switch off altogether, and then are immediately reactivated if the sunlight decreases because clouds roll in. The color balance of the light can also be adjusted by varying the intensity of individual LED lamps of different colors installed in the overhead fixtures.

In tests of the system so far, the researchers found that it reduced the energy used for lighting by 65 to 90 percent — and that's on top of the already-high energy efficiency of LEDs compared to incandescent lights and compact fluorescents. And while LED lights are the most efficient, the control system could be used with other light sources as well, including incandescent or dimmable fluorescents.

Preliminary results of the ongoing research, which is funded by the Media Lab, were published this summer in the Proceedings of the SPIE, in a paper co-authored by Aldrich, Paradiso and visiting student Nan Zhao.

## MIT Study: Energy Savings through User-Controlled Lighting Systems

These days, in newer buildings it's often hard to even find a plain old-fashioned light switch. Often, the only controls are automatic motion-detector switches that turn off lights when people have left a room — or when they sit too still — or else daunting control panels with arrays of sliders and buttons. But some researchers at the MIT Media Lab are aiming to put the controls back in people's hands, in a way that provides sophisticated and continuous control and could slash lighting bills by more than half.



Visiting student Nan Zhao works in the test setup at the Media Lab. The currently used device that incorporates sensors and controls is not much bigger than a credit card (photo courtesy of Matt Aldrich).

The experimental control devices being tested by research associate Matthew Aldrich are about the size of a business card, and thin enough to slip in a pocket. They monitor the light actually falling on the user's work space, and contain light sensors as well as controls to adjust both the intensity and the color balance of the light. In the test setup, this information is used to control an array of LED light fixtures, the most energy-efficient kind of lighting now available that can be easily adjusted to any level of intensity.

While the system works in its present form, it needs to ramp the lighting up and down to calibrate the sensor whenever it is moved, and this can produce a distracting but brief sequence of light and dark. Aldrich is now working on a system that incorporates invisible infrared (IR) LEDs in the light fixtures and IR sensors in the controllers. In this way, when the relationship between the IR and visible light is properly calibrated, the adjustment of light levels and the system calibration can be done invisibly and without unnecessary distractions. The group is also using cameras to measure reflected light across illuminated areas and is studying ways of using gestures for lighting control.

In addition, Aldrich plans to do further testing on user reactions to the system in order to optimize the control systems to match user preferences. For example, would it be more effective to let each user control the lighting for his or her own space, or to allow a single control for an area or a work group? And is it better to have the controls in fixed locations, or have portable devices that control lights as a user moves around in the building? "We want to see how users will interact with it, to see if we can really realize these energy savings," Aldrich says.

Jeffrey Cassis, the CEO of Philips Color Kinetics says that the team doing this work "is world-class — they are working on a hard problem and a quality, cost-effective solution has great potential." He says that it is important to use a systems approach, as this team is doing, looking at the whole lighting system rather than just individual components. But he adds that the cost of the finished system, as well as how easily it can be used to retrofit existing lighting systems, will be crucial factors in determining its adoption.

And Bob Karlicek, director of the Smart Lighting Engineering Research Center at Rensselaer Polytechnic Institute, says such systems offer the "possibility of much higher energy saving than can be obtained through LED lighting without intelligent control systems." "But," he adds, "there are still significant technical barriers that need to be overcome on at least three fronts: higher efficiency color adjustable LED lighting, new types of lighting sensors that can be used to control lighting systems, and new ways for people to interface with adaptive lighting control systems for maximum productivity and comfort." ■

We bring quality to light.

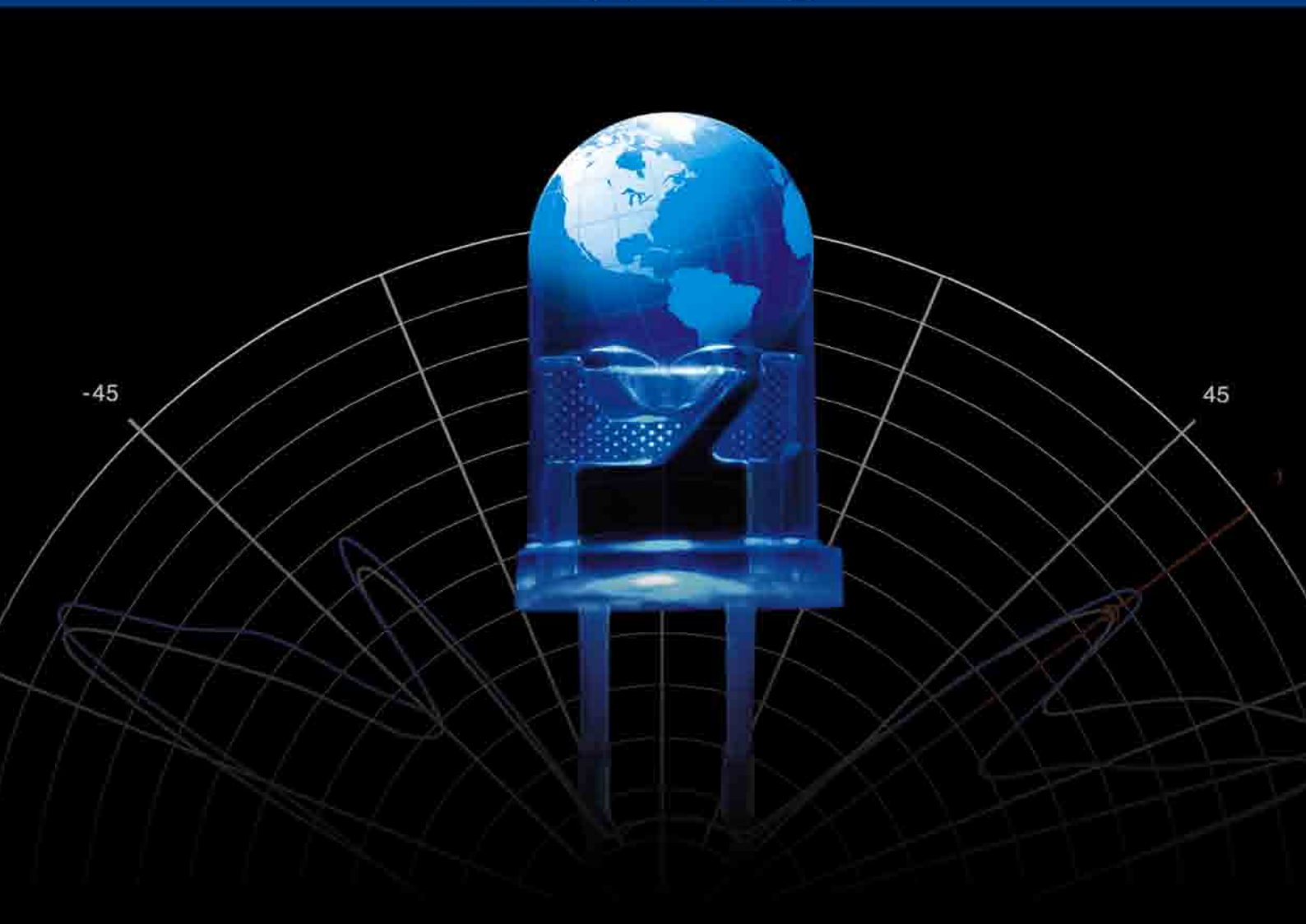

## LED test & measurement solutions from the world leader

Instrument Systems continues to set the benchmark in LED metrology. Whether testing individual LEDs (standard or high-power), LED modules, or OLEDs - the global LED industry relies on us to engineer superior measurement equipment for high-speed production testing and high-performance R&D and QC applications.



### Our instruments provide accurate and reliable results as per CIE recommendations and methods:

- Luminous flux [lm], luminous intensity [cd], and luminance [cd/m<sup>2</sup>]
- Chromaticity coordinates x,y,z and u'v'
- Color temperature and color rendering index
- Dominant wavelength and spectral data
- Spatial radiation pattern

 **Instrument  
Systems**  
light measurement

# The Display Industry Drives OLED Technology

Alan Mills reports from the Intertech-Pira OLED-Summit meeting, where remarkable progress in OLED display technology was seen and shows how it influences the OLED market for general lighting.

Today's annual worldwide lighting market is about \$100 billion with the US share being about 20%, and the European share close to 40%. Light Emitting Diodes (LEDs) account for less than 1% of the lighting market with organic light emitting diode or OLED display sales being in the same value range. However, most OLED devices are small displays with the estimate for world sales being about \$650 million in 2010. This value represents a 30% growth over the previous year, and a continuing rapid growth for organic light emitting diode (OLED) technology for the foreseeable future. The US Department of Energy actively supports both OLED and LED technology development, with allocations in 2010 of about \$60 and \$90 million respectively. This OLED investment is equivalent to almost 10% of annual worldwide sales, where the vast majority of these sales are for portable small display applications including cell phones, MR3s, or cameras.

Although small OLED displays are increasing their market penetration, progress in the OLED TV market will be slower. Prototype OLED TVs, such as the LG 31-inch AMOLED and Mitsubishi 155-inch PMOLED models, have recently been demonstrated, but high volume manufacturing lines are still only in the planning stages. Several performance factors such as the electron mobility of the TFT backplanes and their voltage stability, plus image sticking, blue emitter lifetimes, scalability, preferred threshold voltages of less than 3.5V, comparative cost, and sagging shadow mask alignment issues for large displays and TVs will have to be solved for Gen-6 production lines before widespread market acceptance of OLED TVs becomes more realistic.

Jueng-Gil Lee from LG Display and others have reported that typical blue emitter materials only have lifetimes in the 5,000-10,000 hour range, whereas the green and red emitter lives to 70% brightness are at least in the 70,000 to 100,000 hour range. In 2009 OLED TV costs were about 10x

those of LCD models with roadmap forecasts indicating a reduction to 3x in 2013, 1.5x in 2015 and a crossover or 1.0x in 2017. Most of these cost improvements are anticipated from lower material costs and higher manufacturing yields. However, the achievement of these goals may be difficult; since the ideal process materials and process technologies have yet to be defined for the production of low cost large panel TFT based OLEDs. Additionally, today's OLED TV panels use two layers of glass for support and encapsulation. Therefore, the development of lower cost designs with one glass sheet and plastic encapsulation is a must achieve factor.

## Small OLED Displays

Companies such as LG, Motorola, Nokia and Samsung have previously marketed cellphones with OLED displays, but Samsung Mobile Displays Division had allocated significant funding for OLED displays in order to target increased penetration of the cellphone market. This resulted in Samsung OLEDs accounting for about 95% of the 2010 small display market value. A majority of Samsung sales have been used internally for cellphones, even though OLED displays are believed to be double the cost of LED illuminated equivalents. Jennifer Colegrove, from Display Search stated at the Intertech-Pira OLED-Summit meeting that the Samsung Galaxy Series (see Figure 1) displays have a 2x VGA resolution with 235dpi and 800x400 pixels. For comparison, the Apple iPhone-4 offers 326dpi with 960x720 pixels. However, OLED displays could

**Figure 1:**  
The Samsung Galaxy Series is just one example where small OLED displays are used





not be considered at this time for the Apple phones because there is not enough capacity worldwide to supply their present shipment levels. This situation could change in the future because up to 10 new OLED-fabs may be built in the next two years.

The benefits claimed for mobile active matrix (AM) OLED displays are thinner displays (compared to AM LCDs), less weight, lower power use, improved definition or visibility, good touch screen capability, no back lighting units required and eventually lower manufacturing costs. However, barring rapid process technology breakthroughs, significant challenges still exist including; display cost, a lack of high volume manufacturing lines (excepting Samsung), the lifetimes of blue emitters (organic small-molecule or polymer) and power requirements. Today, there is a reduced demand for the more mature passive matrix PMOLEDs. Hence, AMOLEDs with amorphous silicon thin film transistor (a-Si TFT) backplanes have become the preferred technology. However, the relative cost of the silicon TFT backplanes may be a near term impediment to a successful competition with AM LEDs and LCDs, therefore oxide TFTs are being evaluated for lower manufactured cost AMOLED alternatives. Additionally, low temperature processed TFT backplanes for future large, flexible OLED displays are one of the challenges to low cost manufacture.

At the Intertech-Pira OLED meeting, a report from the Samsung Mobile Display Division indicated that it is currently focusing on small to medium sized AMOLED displays for the 2010 to 2012 near term and noted the advantage of not requiring a back lighting unit. Ho Kyoon Chang mentioned that the company plans to expand into OLED TV markets and 'some unique applications' by 2013, followed by the 'next big thing after TVs', large displays. Presuming the technical issues are solved, a 50% penetration of some markets is forecast by 2015, including an expanded use of OLED touch screen technology. Display power-use efficiencies are continuing to improve

for two-inch displays, from a low 15 candela per A (cd/A) performance in 2007 to 20 cd/A in 2009, 24 cd/A in 2010, and are forecast to achieve 30 cd/A in 2011. Consequently, the respective power draw for a 2-inch display should drop from about 400 mW per display in 2009 to 252 mW in 2012, thus allowing a better competitive position for OLEDs against LED backlit displays. However, this is a moving target since the luminous flux, lm/W and lm/\$ outputs of LEDs are also still improving, with 150-180 lm/W outputs from one Amp LEDs being expected by 2014.

Comparative display resolution has been reported as 350 ppi for LEDs, 330 ppi for OLEDs, and 240 ppi and higher for the iPad, but pixel densities continue to improve. Increased current densities are desirable for brighter OLED displays, but they increase the operating temperatures and increases as small as 5°C can lead to shorter OLED material and display lifetimes. For future displays, Jong Huyk Lee from Samsung's OLED Technology team has stated that the company is focusing on their LITI (Laser induced thermal imaging) process, which needs additional process development, but it will have no ppi limits. Paper-thin displays of under 0.5 mm are another goal and could open up new OLED markets such as credit card, driver's license, ID card and e-passport uses.

As OLED technology continues to advance, the outlook for touch screen OLED displays appears to be very promising and market forecasts for these displays range between \$6 and \$12 billion for 2018, with Samsung promoting the more aggressive forecast. The \$6 billion estimate by Display Search is based on sales of 60 million square metres of small displays at an average price of \$100/M<sup>2</sup>. However, with an estimated cellphone market of 2 billion units in 2015, and if one third of these are fitted with OLED displays, it would represent an even larger OLED display market of about \$14 billion at \$20 per display (without any contribution from OLED TVs and large displays). This plausible scenario even exceeds the above 2018 forecasts and would

represent significant penetration into the well-established worldwide LCD panel display market that passed the \$100 billion mark in 2008. However, it presumes that sufficient display manufacturing capacity would be available. With estimates of 3 million square kilometers of OLED devices being sold in 2012, an annual market for about 300,000 tons of OLED related materials would be created.

In addition to their small display production and R&D at Samsung Displays, Ho Kyoon Chung, reported to the Intertech meeting that their near term large-format work is focused on TVs and large flexible displays. After TVs, their R&D will lead the company into large flexible screen displays and OLED wallpaper for room or space lighting. It is interesting to note that in a parallel situation to the LED of about 15 years ago, commercial small display applications technology is supporting much of the developing lighting technology for OLEDs.

**Figure 2:**  
The "Tree Lamp", designed by Ingo Maurer 2008, and made by Osram is an early example for OLED lighting, expressing more of an art form than a solution to a lighting need



### OLEDs for Lighting and Large Displays

Today, only a few OLED lighting prototypes are being manufactured in small quantities and promoted by such companies as Acuity, GE, Osram and Philips. They are more of an art form than a solution to a lighting need, with the first example being the "Tree Lamp" made by Osram in 2008 (see Figure 2). This Ingo Maurer

**Figure 3:**  
A more recent  
ceiling luminaire  
from 2010

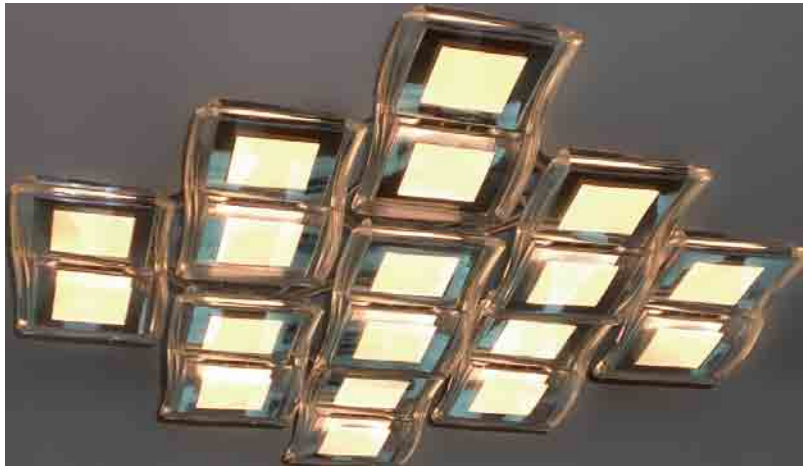

**Figure 4:**  
New improved  
OLED structures  
allow higher  
luminosity,  
recently up to  
3,000 cd/m<sup>2</sup>



designed lamp, with only about 2000 hours to 50% luminance, produced low intensity lighting from small oblong panels with claimed benefits of no glare, decorative, form factor and art values. A prototype OLED ceiling-panel luminaire has also been reported (see Figure 3). Such OLED luminaires are expensive, but their sales presently have insignificant value when compared to the general lighting market and face tough competition from the latest fluorescent lamps and light emitting diodes (LEDs), with respective 80 and 110 lumen per watt (lm/W) efficiencies and much lower costs. The 150 lm/W efficiencies and lower costs expected from LEDs in 2012 will provide even more competition. However, the goals for OLED lighting are to convert walls, windows and ceilings into no-glare light sources and to provide thin, flexible and transparent large displays.

The best lumen per watt outputs for OLED devices vary widely with existing luminaires producing about 25 lm/W and rising to 40 lm/W in 2011 versions, although R&D OLEDs have been reported at 102 lm/W. Higher values in the 60 to 100 lm/W range are usually

from small pixel OLEDs that have little correlation with lm/W outputs for OLED lighting panels. For this reason the US DoE no longer accepts OLED pixel performance values as a measure of OLED performance. A roadmap milestone of 60 lm/W for an OLED panel was the goal for 2010 rising to 100 lm/W in 2015 at a 10,000 lumens per m<sup>2</sup> luminosity rating. Triplet spin-state OLED emitters, utilizing phosphorescence, are the answer to the higher performance since they allow almost 100% internal quantum efficiencies (IQEs) and also waste less power as heat.

According to Janice Mahon from Universal Display Corp. (UDC), their company now offers under their PHOLED™ trademark, emitters with long-lived estimates to 50% output (95 to 500k hours), reds that produce 15-28 lm/W and greens with 60-75 lm/W. UDC also recently demonstrated an 8x8-inch white OLED panel with about 3000 cd/m<sup>2</sup> luminosity, see Figure 4, that uses a 2-blue, 4-pixel (Red, Green, Blue1 Blue2) arrangement for their P2OLEDs. However, even fairly new blue OLED emitters are not as durable, with one of the most recent UDC

blues being rated at 9000 hours with an output efficiency of 46 lm/W. As noted earlier, short-lived blue emitters could slow the acceptance of OLED luminaires for lighting applications.

In furtherance of the flexible-sheet OLED technology, both Samsung and Sony demonstrated prototypes in 2010. Presuming success, Samsung expects this market to achieve \$100 million in sales by 2012, \$2.4 billion in 2015 and \$30 billion by 2020. Samsung plans to focus on large ultra thin rollable displays and OLED wallpaper for lighting after it has established an OLED TV market. Successful flexible display production will depend on technology solutions to several challenges (low cost film, flexible electrodes, low temperature TFT processes and display bending radii of about 1cm), but the most important challenge is the development of substrates and multi layer barriers that exclude air and water. Samsung has reported recent progress toward these goals with the development of a flexible 2.8 inch AMOLED display using a low temperature poly silicon TFT process and multi layer ALD/MLD barrier films. MLD (molecular layer deposition) is a recently developed process that alternately delivers trimethyl aluminium and ethylene glycol (EG) to form Alucones, inorganic/organic hybrid polymers. This AMOLED can boast a bending radius of < 1cm, 0.24mm thickness, 240x400xRGB (166ppi) resolution, 250 cd/m<sup>2</sup> luminosity and weighed only 0.29 grams (see Figure 5).



**Figure 5:** New AMOLED displays have a narrow bending radius

Several large-OLED manufacturing techniques and organic materials systems are under testing, including:

- Small organic molecule (SM) OLED devices by deposition in an OVPD (organic vapor phase deposition) process (see Figure 6)
- Organic polymer OLED devices (POLEDs) either using polymers in solution that are spin-coated or use inkjet deposition and roll to roll transfers that combine pre-formed OLED layers and
- Mixed-material layered OLEDs that use both material types in solution. To date, the final selection of a manufacturing process has not been reported.

Fortunately, worldwide R&D continues to improve OLED luminaire luminous flux levels, lifetime performance and dollar per lumen cost. As large-OLED manufacturing technology continues to mature, the OLED industry goals of large display and luminaire OLED production becomes ever closer. ■



Figure 6: AIXTRONs advanced OVPD® furnace for small OLED production

INNOVATIVE HEAT MANAGEMENT AND OPTICS TECHNOLOGY

## WATERPROOF LED WALL LIGHT

IP66, Can Be Used For Outdoor Lighting



### WL-030-AW-01

Life Span: 50,000 Hours  
 Standard Warranty: 3 Years  
 IP Rating: IP66  
 Power Consumption: 30W  
 Input Voltage: 100~240V AC  
 LED Type: Edison or Cree  
 Color Temperature:  
 Cool White: 6000-7000K  
 Warm White: 2800-3200K  
 Lighting Both Two Sides  
 Excellent Thermal Diffusivity



warranty 3 years



SIGNCOMPLEX LTD

Vijia Industrial Park, Fuzhan Road, Guanlan Town, Baoan, Shenzhen  
 Tel: +86 755 2780 8650 Fax: +86 755 2780 8651  
 www.signcomplex.com info@signcomplex.com



# The Future of LED Systems is Digital

At the VDI conference, Peter Deixler, Global Senior System Architect, LED Lamps & LED Systems from Philips Eindhoven gave a comprehensive overview on „Trends in SSL Driver Electronics & Luminaire-based Controls.“ Arno Grabher-Meyer from LED professional got the chance to discuss that exciting topic with him.

**LED professional:** One key issue of your speech was the change from an analogue world to a digital world for driving LEDs. That approach does not sound very new, because in industry, the term “digital power” is often loosely defined with respect to power supplies. Sometimes the term refers merely to a switching power supply.

Could you please give us a short and clear definition of what a real digital driver or power supply is?

**Peter Deixler:** In a “Full-Digital” LED Driver, the control of power converter is realized by means of a microcontroller with digital control loops. Tuning of the power conversion is done via change of algorithms or parameters. By adjusting the software, the same micro controller can be tailored to control a wide range of advanced power converter topologies. Digital features like DALI interfacing or advanced features are directly done by the same power-conversion microcontroller, rather than having the cost-adder of an extra microcontroller.

This is quite different to the “classic Analogue” Driver Approach, where the control loops of power converter are realized either with analogue electronics components or analogue ASICs, which are optimized only for a limited number of power topologies.

**LED professional:** Is this approach especially favorable for SSL lighting? Why or Why not?

**Peter Deixler:** In a full-digital driver, the software has direct control of everything within the lamp. This enables rather straightforward digital feature integration. Additionally, the microcontroller enabling these digital features is already “paid for” by the power conversion. Digital light-sources will offer many new possibilities for customers, such as smart office buildings with distributed daylight and presence sensing. For the consumer space, smart energy saving and ambience creation in homes will be a hot topic.

**LED professional:** What are the advantages of these types of digital solutions in general?

**Peter Deixler:** We believe that digital/programmable solutions will create a competitive edge for lighting fixture manufacturers. In our digital LED drivers we use software for customization and diversity management, such as flexibly setting the LED driver output current in factory or in field.

In the SSL lighting, keeping the edge against completion will mandate a fast innovation heartbeat, which points towards frequent software updates rather than keep changing the hardware. If we look further into the future, the “Design for Recurring

Revenue” lighting solution business models will ask for secure feature upgradability in field.

**LED professional:** At VDI you also demonstrated how a digital approach allows the reduction of driver size, especially due to higher operation frequencies, resulting in miniaturized magnetic. What is your opinion regarding the integration of passive components in silicone?

**Peter Deixler:** Indeed, Full-Digital-Control of the power conversion enabled the use for our product innovative high-frequency power electronics topologies, for which no analogue ICs are yet available. This translated in considerable miniaturization and power conversion efficiency gain, as illustrated by the market leading 2x size reduction for our 50W indoor digital driver product.

**Figure 1:** The full-digital approach of the Philips Xitanium 50W DALI driver (foreground) yields a 2x size reduction compared to its analogue predecessor (background)



This digital driver already has a very high degree of silicon integration. All control of the power conversion and

DALI networking is integrated in one single piece of silicon, which features both the digital logic, flash memory, and optimized analogue “peripheral” functionalities controlling the power MOSFETs directly.

When it comes to passive components integration into silicon, we have been following it for quite a while. While recent technological progress on integrated high-density capacitors is impressive, as soon as you also embed passive elements such as capacitors and inductors into silicon, your integrated semiconductor module pretty quickly becomes inflexible. This is fine, as long as you have a very mature electronics design and high levels of manufacturing volume to economically justify the peak design.

**LED professional: In your presentation you differentiate between light sources and consumer luminaires used primarily for home applications, and more sophisticated solutions like the systems for commercial applications. Are both applications equally well suitable for applying the digital approach? Where do you see the main differences?**

**Peter Deixler:** For consumer lighting products, right now the critical success factor is compatibility with the existing legacy infrastructure, such as wall dimmers and low-voltage transformers.

Regarding future lighting control applications for homes, they need to be in line with the consumer market boundary conditions on commissioning, security, ease of use, network scale and cost. Therefore Philips is active within the Smartlight consortium to create a simple and sensible industry specification for RF control of over-the-counter lamps and Luminaires in the consumer market space.

For commercial building applications, the lighting solutions are typically larger scale and often require PC-based commissioning by an expert. Typical

examples for new digital opportunities include multisite tele-management solutions in shops and energy-saving audit and services driving accelerated renovation of the installed base.

**LED professional: Before we go into more depth and discuss the advantages for the commercial applications, let's have a look at consumer products. Today, the mainstream for low-cost dimmable solutions is based on phase cut or Triac dimming. Is this really the right solution, or doesn't that just make sense for replacement lamps for the time being?**

**Peter Deixler:** In Europe alone, more than 120 million wall dimmers are installed in homes. The US has another 150 million phase-cut dimmers. Having all these consumers call their electricians to replace their wall dimmers would hinder the adoption of energy efficient LED lighting. Hence for us, a true “Retrofit” will require LED lamps, which have a performance similar to incandescent dimming with the existing legacy wall dimmers.

Making a 6W LED lamp function flawlessly on a dimmer requiring a minimum load of 60W is a technical challenge. There are also several different dimmer types. The good news is that first LED lamps are becoming available, which are compatible with both leading-edge (Triac) and trailing-edge (MOSFET) dimmers. For instance, in the recently announced Philips 60W-replacement LED lamp, we have cracked this nut by pulling the highly non-linear dimmer interaction problem into the digital domain.

For serving simple group-dimming applications, we believe that a fine-tuned interface between phase-cut dimmer & LED lamp will still be the most affordable group dimming control in the future, both at a lamp and system level. We see that first dimmer manufacturers are releasing new phase-cut dimmer products, which are especially suited to SSL, but still offer

the backwards compatibility to conventional lamps such as halogen or GLS to the end-user.

**LED professional: On a long term run, are there perhaps better concepts for home applications, for example, solutions like switch-dimming (Consumer SSL 2.0)?**

**Peter Deixler:** For applications requiring individual control of lamps (rather than the traditional group-control), digital interfaces beyond phase-cut will be used. For the long-run, we in Philips believe that for homes RF is the most promising candidate for SSL 2.0. RF offers full flexibility for new “green-field” lighting applications way beyond what can be done with wall dimmers or wired connectivity such as DALI. Especially for residential renovation and DIY, having lighting controls requiring “no-new-wires” is a key enabler. We expect that in a few years the cost per RF control node will be significantly lower compared to schemes communicating via the existing electricity wiring. This is because the RF bill-of-material is dominated by high-price-erosion digital and low-voltage components shared with the IT and telecom industry

**LED professional: One definite challenge for the SSL industry is the MR16 replacement, due to the compact size (thermal management) and the requirement to work flawlessly with any Halogen 12V transformer. What is your opinion about that?**

We in Philips have just introduced 50W-and 35W low-voltage halogen replacement lamps. These MR16 retrofit lamps, work flawlessly on any Halogen 12V transformer while saving up to 80% energy. The transformer compatibility is enabled by a patent-pending LED lamp electronics breakthrough.

We also have first dimmable MR16 products, which are compatible with existing 12V transformers and some of the installed-base legacy phase-cut dimmers

**LED professional:** Regarding the commercial market, up until now, a system has often consisted of a control, a supply, and an LED driver. Every single stage has its specific losses.

**Can the digital approach join these components without sacrificing the quality and at the same time possibly help to save additional energy?**

**Peter Deixler:** Indeed we have achieved with integrated electronics very high efficiencies compared to a stand-alone driver, especially for the low to medium driver wattages. As the driver wiring to the LEDs cannot be touched, fully integrated solutions can omit the electrical safety isolation required for stand-alone drivers. This opens the door to innovative electronics topologies with lower component count and reduced electronics waste, which is an important aspect for cradle 2 cradle. Above all, for the customers, the integrated driver electronics enables easy-to-use modules, which can be connected directly to mains (230V AC). However, the high-temperature environment within integrated light-sources places requires careful driver electronics design.

**LED professional:**The integration of the controls part seems to be one of the biggest advantages.

**What are the advantages of adding intelligence to the ballast, for example, new functionality?**

**Peter Deixler:** For example, our outdoor digital driver is recording the times when the municipality is switching the power of their streetlights on and off. Based on the information of the last three days, the driver determines the month and then applies an optimized timing profile of the light output over the night. In June in Holland, we use a light-output profile with lower peak intensity than in January.

**LED professional:** The digital driver concept can also enhance other technological trends in SSL lighting. One trend is the implementation of

**LED modules, and a further step is the integration of the electronics in the LED module. Philips supports both approaches with different versions of Fortimo modules.**

**Do you see application-specific distinctions in the degree of advantages?**

**Are there additional advantages (for instance costs)?**

**Peter Deixler:** When compared to LED systems with external driver, the integrated electronics will certainly lower the required initial investment for certain LED applications. For example, we expect that the integrated-electronics Philips LED modules in the 300 to 800lm range will enable faster market penetration of LED systems in the price sensitive hospitality and consumer segments. The integrated driver electronics is also leading to breakthroughs in system compactness and flatness. For high lumen applications, such as street-lighting and offices, I still consider stand-alone drivers as the best approach due to thermal considerations.



**LED professional:** All these aspects have a big influence on the lighting industry.

**Will there be classic luminaire manufacturers or ballast manufacturers in the future, or will SSL change the industrial landscape?**

**Peter Deixler:** For the lighting industry, LED is a rather disruptive new technology. LED lamps and LED modules for mainstream applications will be a high-volume-electronics environment, where economy of scale and fast innovation are ruling. Hence we believe that the luminaire manufacturers will leverage LED

light-source modules, rather than getting their own soldering iron out and continuously upgrading to the latest LEDs.

When it comes to the lamps and gear manufactures, I believe that vertically integrated players, such as Philips, spanning from LED components, ballasts to LED lamps/modules are placed well in the world of digital lighting; they can determine their overall LED system architecture solely on what integrally gives the highest value & simplicity to the customer.

**LED professional:** Finally, I'd like to ask you a question apart from the digital approach. There are many other trends in LED lighting. Which is/are the most important one/s for you personally?

**Peter Deixler:** I personally find the high-speed inroad of TLED (tubular LED) very exciting. We have just globally launched a TLED lamp product, with T8 form factor. First Philips TLED applications examples include hypermarkets in Indonesia and Singapore (Figure 3), where sustainability plays an important role. We also see commercial traction whenever TLED successfully addresses TL limitations, such as in vending machines, 24/7 covered car parks or extremely dusty industries, where TLs often have maintenance factors of 0.5.

To decide for which applications TLED or conventional TL makes sense now, it is important to assess the lux level on the task area rather than following overly simplistic lm/W comparisons at lamp level. The directional nature of the TLED has an intrinsic advantage over TL light, which for instance encounters up to 35% optical losses in bare batten fixtures.

Many people are concerned about seemingly exaggerated lifetime claims and the spotty appearance of tubular LEDs:

I recognize that many TLED products with questionable records are entering the market. We have just tested a product, where an installer inserting

**Figure 2:** The Philips Intuos LED disk replaces 60W halogen and incandescent lamps for hospitality and home applications. The integrated electronics enables a cost-effective and small module



**Figure 3:**  
Giant  
supermarket,  
Jakarta,  
Indonesia. Project  
with a total of  
4000 Philips  
MASTER LEDtube

this specific TLED tube without switching off the electricity, is directly exposed to a mains-voltage shock at the end-cap. In the Philips TLED product we have put great emphasis on system safety under foreseeable misuse, next to fulfilling the lighting regulatory requirements on glare & uniformity and meeting the user preferences regarding the tube's uniform visual appearance. We base our 30k-hours lifetime predictions for TLED onto calibrated models based upon many years of fluorescent and LED expertise in Philips.

**LED professional:** Thank you for discussing the most recent SSL trends and digital drivers, with LED professional. ■



#### Peter Deixler:

Peter Deixler has been working as Global Senior System Architect at LED Lamps & LED Systems Philips, Eindhoven, Netherlands since 2006.

From 1998 to 2006 he was Lead Architect for RF Process Technology & SSL Emerging Business at Philips Semiconductors/Research, New York, Eindhoven & New Mexico.

Peter Deixler studied Technical Physics at the Kepler University in Linz, Austria, and Microelectronics at the University of Manchester, Institute of Science & Technology, U.K.

During his leisure time, he enjoys mountaineering and skiing, or visits and listens to operas.

# Kingbright

[www.kingbright-europe.de](http://www.kingbright-europe.de)

+49 2835 - 44 46-0

## Kingbright's most popular Through-hole and SMD-LEDs in super-bright pure-orange

Dominant wavelength: 605 nm  
Peak wavelength: 611 nm  
Forward voltage: typ. 2,2V – max. 2,8V  
Luminous intensity up to  
typ. 18.000 mcd @ IF 20mA

100%  
ORANGE



Quality — Efficiency — Innovation — First-class service

# Intelligent Lighting (Part II): From Definition to Implementation

While Osama Mannan, Technical Marketing Engineer of Future Lighting Solutions presented the different technologies used in an intelligent lighting system and the benefits that can be achieved using different approaches in Part I, in Part II he explains how the features presented previously can be implemented with different levels of complexity, depending on the location and the requirements of the application.

**Figure 1:**  
A simple intelligent controller and sensor system

Looking closely at an intelligent lighting system, the implementation of the system comprises of a combination of a wide range of products depending on the application and its requirements. This article will focus on three implementation approaches and the products that can be leveraged to develop the intelligent lighting system.

## Basic and Direct Control

A key feature that intelligent lighting control brings to LED lighting systems is dimming. In indoor applications, the most basic form of dimming can be achieved by using wall dimmers at a fixed location in the room. Standard wall dimmers send different types of signals for controlling the brightness of the LEDs, namely TRIAC, 0-10V, and DALI, and 12V Pulse Width Modulation (PWM). The dimmer has to be interfaced with an LED driver that supports any of these signals in order to ultimately control the light levels of LED luminaires. There are several dimmable LED drivers available on the market from a number of vendors, offering various output voltage ranges and drive currents to support several LED configurations.

Additionally, a simple sensor system can be added to trigger dimming or ON/OFF switching. For instance, a motion detector can be placed in the room to sense presence and send a 0-10V signal to the driver to change the state of the LED fixture from OFF to

ON, or vice versa. Alternatively, a DALI-based sensor can be used to broadcast the signal to all the fixtures in the room and trigger the same action. Although communication using DALI can address each fixture and control them individually, a simple implementation of DALI would only require one signal to be broadcasted and initiate control to all the fixtures collectively. The sensors can work with a controller, which can be installed either stand-alone or integrated inside the LED driver. An example of such a system is Philips ActiLume. Combined with a pre-programmed controller, these systems consist of miniature ambient light and motion sensors that can be set for different modes of operation giving the system more versatility based on the requirements. The controller also includes a power relay, which enables ON/OFF switching of the light fixtures. Figure 1 demonstrates the functions of such a system when installed in the luminaire.

In Figure 1.a, the motion sensor detects the absence of movement in the room and sends the command to the controller to turn OFF the lights. Similarly, Figure 1.b shows the ambient light sensor sending the signal to dim the LED luminaire due to the appropriate level of illumination provided by the sunlight. This operation will ultimately lead to energy savings by reducing the power consumption of the luminaires when not required.

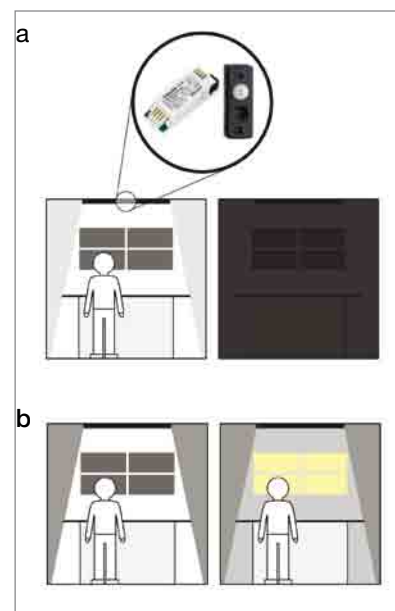

As for a simple implementation of an outdoor application, the use of sensors can be eliminated and a programmable dimming controller can be used to schedule actions. For example, Philips LumiStep dimming controller, which is a standalone controller, but has also been integrated inside some LED drivers, provides pre-set dimming modes based on the need of the application. The controller will set the driver to dim for a certain period of time depending on ON/OFF switch points. The dimming options include 6 hour and 8 hour dimming periods depending on the requirements and product selected. A dynamic timer changes the dimming mid point as time passes. Figure 2 shows an outline of the controller concept implemented in street light poles. For instance,

**Figure 2 (left):**  
Dynamic dimming control for street lighting

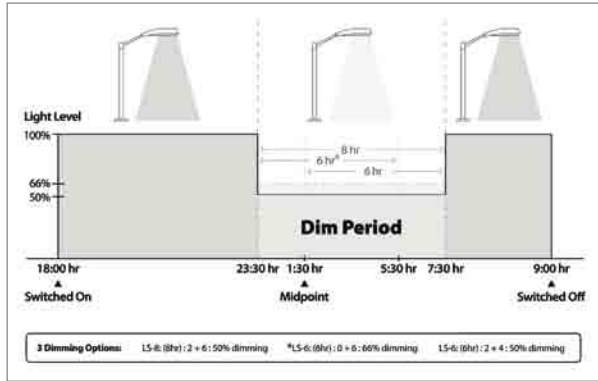

**Figure 3 (right):**  
Programmable dimmer control for street lighting offer additional options

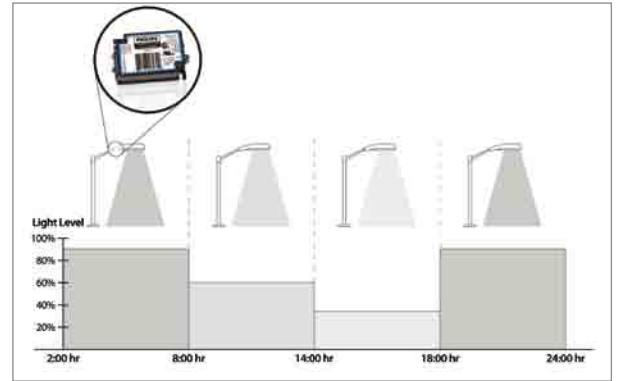

considering the 8 hour dimming option, the controller will dim the lights by 50% two hours before the midpoint and then go back to full intensity six hours after. This implementation option is commonly known as “2+6”. Depending on when the lights are switched ON and OFF, based on season for example, the dimmer will adjust the midpoint and dim the lights accordingly.

A more feature rich dimming control can also be achieved, for instance by using Philips Dynadimmer. This controller, which can also be either inside or outside the driver, sends a 1-10V signal to LED drivers and initiates dimming time and levels based on configurable schedules. The dimming schedule in the dimmer is set via a programming kit or computer software. Figure 3 shows a dimmer schedule implemented for street lights to follow a specific dimming schedule to ultimately achieve energy savings.

In summary, the most basic form of control is to send the control commands directly from one component to the other, such as sensor signals to the LED drivers, without feedback or monitoring capabilities. In this case, there is no need for wireless communication RF modules or metering devices in the system.

**Figure 4:**  
Wireless control using Synapse RF Engines

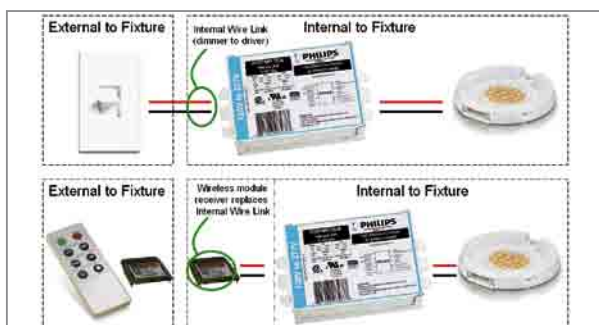

**Local Wireless Control**

The basic intelligent lighting implementation can be enhanced in a local network that includes communication between fixtures and controlling them wirelessly.

For wireless communication, whether it's an indoor office using a 2.4GHz band or an outdoor parking lot leveraging sub-2.4Ghz frequencies, RF engines integrated into the controllers and LED drivers can enable intelligent lighting features within the local boundary of the application, such as a room, a building, or a parking lot. As a result, there is no wide area network or a need to send data over the Internet. For lighting manufacturers who want to design and develop their own controller, the RF engines or IC's can be incorporated to the controllers or drivers. Such RF modules are available from Synapse Wireless. By adding some additional circuitry to the system, these RF engines can be configured to provide a digital or analog signal and can interface with many LED drivers to enable wireless control. The use of such RF engines enables more convenient control of light fixtures as well as eliminating the need for additional cable connections between the controller and luminaires. Figure 4 illustrates how a Synapse RF engine can replace the physical link between the dimmer and the LED driver. The extra circuitry required to send the appropriate signal to the LED driver is not shown in Figure 4.

For a lighting system to communicate and interoperate seamlessly, the communication modules must share the same protocol or network operating system (NOS). An example

of a unified protocol that can be installed in the wireless modules is Synapse's operating system SNAP®. Since SNAP is a network operating system, it can be installed on multiple microprocessor based platforms such as communication modules from various vendors or 8 to 32-bit microcontrollers and radios from multiple IC manufacturers. It enables a robust mesh network that provides embedded intelligence and secure communication for connecting devices with each other, requiring no setup and minimal application development. It's also a multi-hopping and self-healing system that supports software update over-the-air.

Although developing intelligent lighting systems that directly leverage communication modules provides a high level of flexibility, many lighting manufacturers may not have the required competencies to design custom controller solutions. As a result, these lighting manufacturers require a plug-and-play solution that would seamlessly connect to their existing system and achieve the same wireless control capability. One example of a finished system component that already integrates a communication module is the SNAP DIM-10.

As illustrated in Figure 5, the SNAP DIM-10 can be connected to multiple LED drivers, which enables a simple approach to group and control up to 10 luminaires. Furthermore, most dimmable LED drivers do not dim down to 0%, which means that the user cannot directly “switch OFF” the lights. Therefore, the module also includes a power relay that turns off



**Figure 5:**  
An RF controller module connected to multiple drivers and fixtures

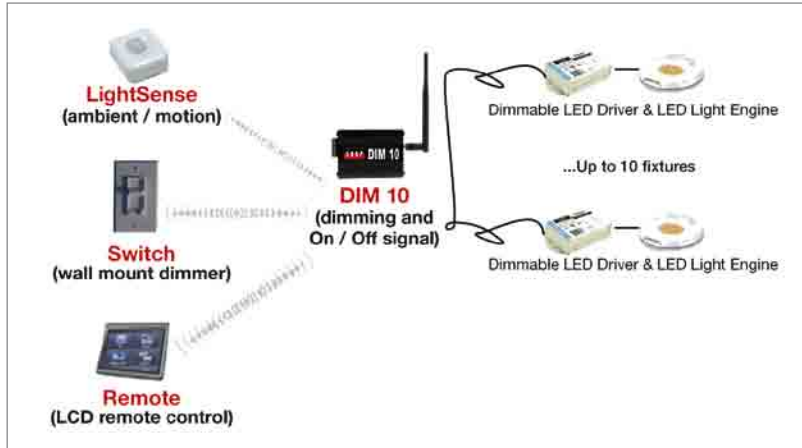

**Figure 6:**  
DMX implementations

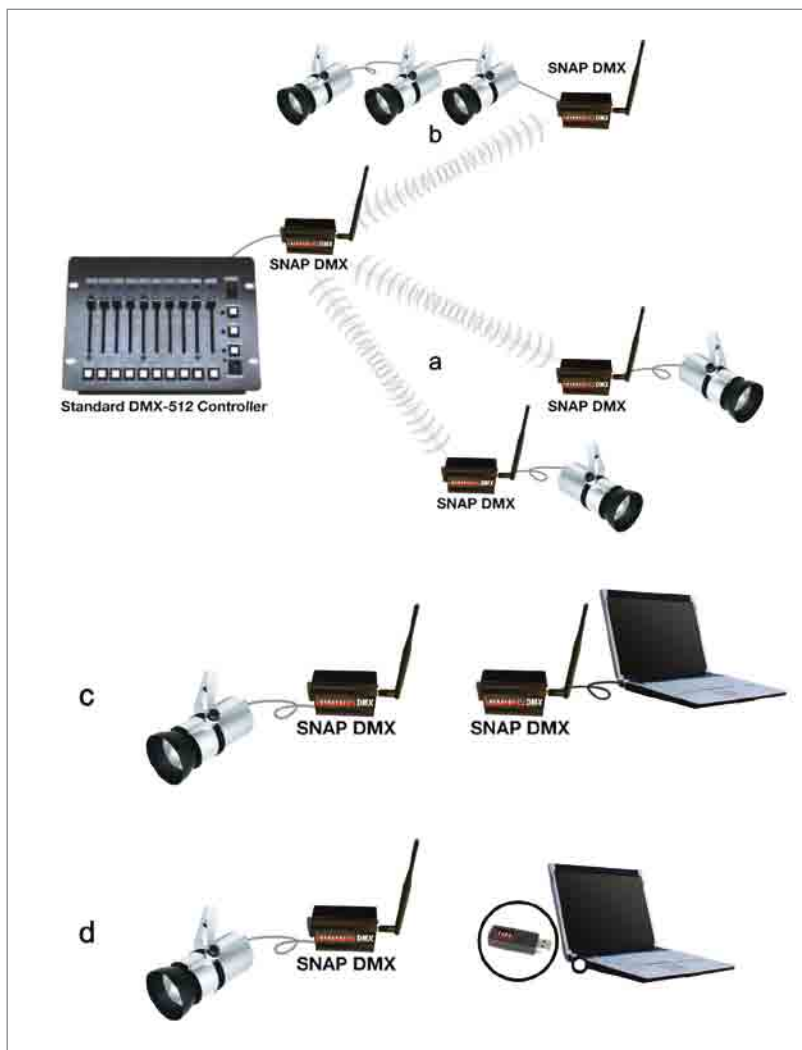

the power to the LED driver at low dimming levels. There are two primary versions available, one that supports 0-10V and PWM dimming signals and the other that supports digital lighting protocols such as DALI. It can receive the control commands from various sources. As shown in Figure 5, a wireless wall-mounted dimmer can be used to control the lights from a fixed location. Also, an ambient sensor and

motion detector would send signals to the SNAP DIM-10 to trigger actions. Additionally, an LCD remote control can be employed to control all the lights connected to the module within the area of coverage.

Besides the standard dimming control signals, such as 0-10V, DALI, and 12V PWM, intelligent lighting can be achieved via the DMX 512 protocol.

One drawback of a DMX system is that it requires a great deal of cabling to control several light fixtures spread apart at different locations.

Consequently, implementing DMX control wirelessly could significantly simplify the installation of the lighting system. Wireless DMX control can, for instance, be accomplished using a SNAP DMX controller, which enables wireless communication between a standard DMX console to existing DMX 512 installations without the need to modify the original equipment.

This DMX controller can be leveraged in various ways. As shown in Figure 6, the module can provide a completely cable-free implementation by connecting a module to each fixture and communicating wirelessly, as in Figure 6a. Another method is implementing a hybrid system which connects the DMX console to one DMX controller that communicates wirelessly to another controller connected to the first DMX lighting fixture. Other DMX fixtures are then physically wired together from the first fixture as they would for a traditional DMX installation, as shown in Figure 6b. Finally, if the DMX console is replaced by a computer, the DMX controller includes a USB port with the appropriate USB-to-DMX conversion capabilities. As a result, third party PC-based DMX software in combination with the DMX controller can be leveraged to send wireless DMX signals to the other DMX controllers, as shown in Figure 6c. For control from a computer, SNAP Stick, which is a compact wireless device with a USB interface, the same size as a standard USB memory stick can be leveraged. It enables plug-and-play wireless control of the SNAP DMX controller, since both communicate using the same operating system (see Figure 6d).

All the components mentioned serve a local network of control that does not go beyond the application boundaries. That is, no wide area communication is established via the Internet, a cell phone network, or remotely via a monitoring base.

**Figure 7:**  
Communication using a gateway

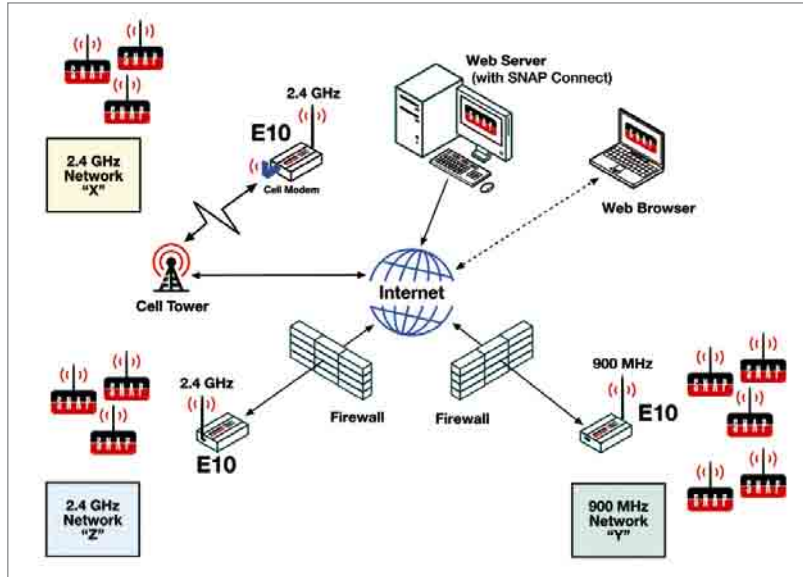

These, in turn, are connected to energy metering modules that measure current and voltage. This entire local network connects through the Internet to remotely monitor the system performance and send out actions accordingly.

This type of arrangement enables control and monitoring of fixtures in groups. That is, the SNAP GridSense will take measurements from all the modules connected to it as a whole, and not for individual light fixtures. Similarly, all the light fixtures connected to one DIM-10 module can be controlled collectively and not separately. This approach allows for the amortization of the cost of the intelligent lighting components across multiple luminaires in order to accelerate payback.

### Wide Area Control

Implementing intelligent lighting on a larger scale allows for full control over the lighting system from multiple locations and enables comprehensive monitoring capabilities. These systems are designed to be scalable with the ability to add locations and metering functionalities with feedback for corrective actions.

Communication via the Internet makes it possible to control fixtures without the need to be near the physical location of the lighting installation. This gives more flexibility to the lighting system and the convenience of controlling the lights from anywhere. For example the SNAP Connect E10 interfaces with other modules that use the SNAP network operating system connects them to the Internet. As shown in Figure 7, the E10 gathers data from all SNAP-enabled modules, where a user can monitor single or multiple lighting installations via a standard web browser. The web-interface can also send commands

from the Internet to multiple wireless modules, to enable dimming, luminaire grouping, and scheduling for the lighting system.

Furthermore, taking measurements of parameters such as current, voltage, and power factor adds monitoring and energy metering capabilities to the system, which enhances energy management options. This information can be relayed to the Internet and stored to a database where reports can be generated or immediate actions can be triggered if necessary. There are several energy metering products that facilitate this task, such as SNAP GridSense that captures and sends energy metering data to the Internet.

A complete hardware system solution is presented in Figure 8. The system makes use of all the components needed for a comprehensive intelligent lighting system. In the figure, sensors send signals to DIM-10 modules that trigger actions in the LED drivers to initiate actions in the light fixtures.

However, if there is a requirement to control and monitor each and every luminaire, intelligent LED drivers that incorporate the energy metering and control capabilities is the most cost effective and flexible approach. Not only does this approach enable better control, it also minimizes the number of components, which greatly improves the system from an efficiency and cost perspective.

Some companies are developing a family of intelligent LED drivers that incorporate the energy metering and control functionalities provided by the components as seen in Figure 8. These fully programmable LED drivers support dimming control using 0-10V and DALI and accept universal input voltages. They also have an integrated control for timed dimming schedules.

**Figure 8:**  
Complete hardware system solution

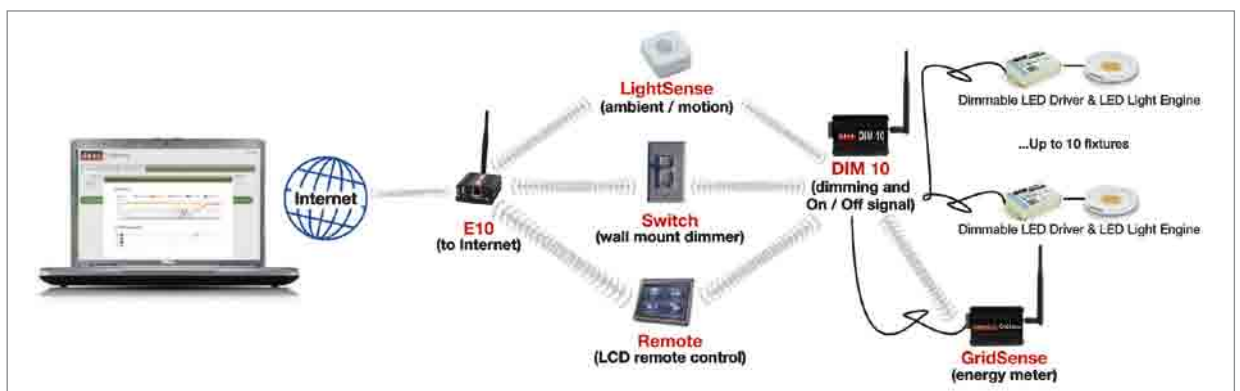

**Figure 9.**  
Complete system  
solution with  
programmable  
driver

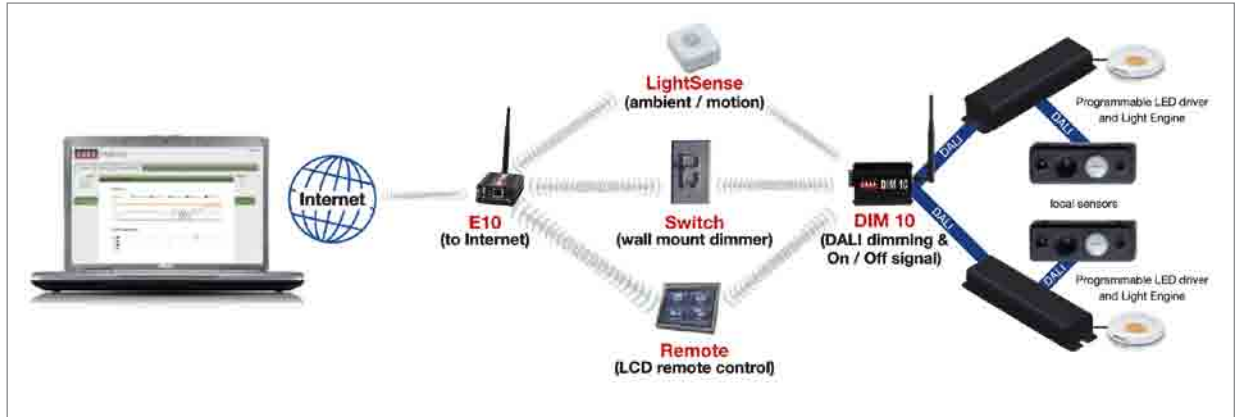

**Figure 10.**  
Complete  
wire-free  
communication  
and control  
system

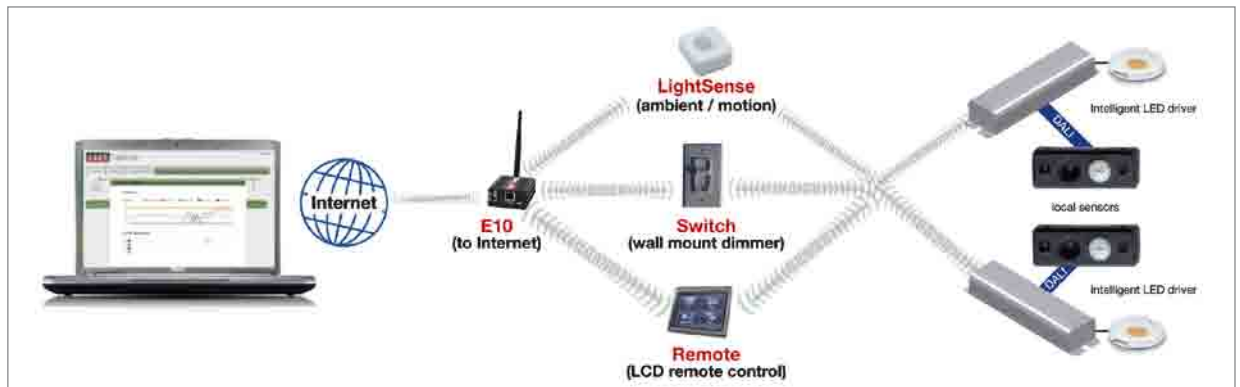

**Figure 11. Web-  
based software  
for commissioning  
and control via the  
Internet**

For luminaire manufacturers that want to provide constant light output over time, these drivers also allow the luminaire manufacturer to program a curve that will automatically increase current over the lifetime of the luminaire to offset the LED lumen depreciation. The driver also collects diagnostic data such as voltage, current, and temperature.

All these control and monitoring capabilities in the driver can be accessed via the DALI protocol. As a result, the DALI version of the DIM-10 can set the drive current and driver dimming level as well as read all the diagnostic data in the driver in order to send the data over the Internet via the gateway. Figure 9 shows how the programmable driver can connect to fixture-based DALI-compatible sensors and replace multiple components, thus simplifying yet enhancing the system.

However, the ultimate goal is to have a completely wireless system that involves a minimum amount of wiring yet provides complete control over the system. Figure 10 shows an intelligent LED driver that incorporates wireless

communication with sensors, controllers, and switches allowing for complete wire-free communication and control with a link that runs all the way from the light fixture to the Internet.

The lighting system monitoring and control from the Internet is achieved by using a standard web-based software that provides the user with full control over the system regardless of the location or control device used. Figure 11 shows an example of an application layout from which the user can set different control criteria to each section and assign different actions accordingly. The lights can be individually controlled or as groups of luminaires, where sophisticated schedules and scenes based on seasons or holidays can be incorporated.

The software can also be used for commissioning the lighting system and allocate functions and rules to the light fixtures based on their role and location. Alternatively, basic commissioning can be achieved by using the remote control at the lighting installation location.



## Conclusion

The implementation of intelligent lighting can include different components with different levels of complexity depending on the application and required features. The solutions presented in this article are either already available or will soon be accessible in the coming months. Whether the system is implemented with the most basic components for simple dimming and sensing, or incorporating more functionality such as energy metering and wireless sensor interaction, an intelligent control system takes lighting design a step further and allows for the development of lighting products that enhance the energy saving and performance value proposition of solid state lighting. ■





The World's Largest LED Event

# LED CHINA 2011

1 - 4 March | China Import and Export Fair Pazhou Complex, Area B, Guangzhou

• 50,000 sqm of exhibition area • 800 exhibiting companies

• 60,000 domestic and overseas visitors

2011  
Highlight

One-stop  
sourcing

- LED Lighting
- LED Displays
- LED Illuminant
- LED Chips
- LED Packaging
- LED Backlight
- OLED, LD, EL, and others
- LED Manufacturing Equipments & Testing Instruments

The Green ideology, led by LED

Organiser : UBM Trust Co Ltd

Add : Rm 1306, Tian He Fu Li Business Mansion, No.4, Hua Ting Rd, Lin He Dong Rd, Tian He Bei District, Guangzhou, 510610, China

Tel : 86 20 3810 6261, 3810 6263 | Fax : 86 20 3810 6200 | Email : led-trust@ubm.com | Website: www.LEDChina-gz.com

Japan | Tel : 81 3 5296 1020 | Fax : 81 3 5296 1018 | Email : christopher.eve@ubm.com

Korea | Tel : 82 2 6715 5400 | Fax : 82 2 432 5885 | Email : sekyoo.oh@ubm.com

Taiwan | Tel : 886 2 2738 3898 / 2738 5598 | Fax : 886 2 2738 4886 | Email : info-tw@ubm.com

USA | Tel : 1 516 562 7855 | Fax : 1 516 562 7854 | Email : cecilia.wun@ubm.com



# Understanding the Pitfalls of Tunable White Light LED Systems

Madhan Kumar and Sachin Gupta from Cypress Semiconductors uncover the secrets of color space and offer solutions that allow fine tuning a white light LED source. This is becoming more of a requirement rather than a sophisticated value-added feature.

**Figure 1:**  
An object illuminated with light sources of different CRI values

Undoubtedly, color plays a significant part in our perception of the world around us. We have often experienced situations where the same object appears differently when illuminated with different light sources, giving the impression that the color of an object is also tied to the light source used. This property of the illuminating light source can be quantized as CRI [Color Rendering Index]. The CRI defines how accurately a sample light source reproduces an illuminated object's color in comparison to a reference light source of comparable color temperature. Figure 1 shows an example where the same object appears differently when illuminated with light sources of different CRI.

White light is the most common light source used, be it in home, industrial, or architectural lighting. As each object is rendered best under a specific light source, it would be a privilege if the user had an option to finely tune the white light source until the object under observation appears at its best. The tuning of the light source may be critical in some applications, like medical lighting. Here, we shall analyze the characteristics of white light and the ways and means to tune it.



Before we jump into the topic of tunable white light, let's briefly understand the concept of color. Interestingly, color cannot be quantized as easily as other attributes like temperature or density. This is because the color of an object depends on the physics of the object, the environment, and the characteristics of the perceiving eye, among other factors.

What humans perceive as color is actually electromagnetic spectrum in the wavelength range of 390-750 nm. The human eye, in general, observes each element of the image on the retina with three different 'cone' types which serve as photo detectors. What makes things interesting is that the spectral response of each of these cones is different. This means that when a portion of retina is exposed to a visible spectrum, the response of each of the cones will be different. Actually, each 'Cone' multiplies the

whole spectrum with its own spectral response. This means that at each wavelength of the incident spectrum, the spectrum strength at that wavelength is multiplied by the spectral response of the cone at the same wavelength and all the products are added to give the resultant response of the cone. In the end, what the brain perceives is a combination of the results of the three cone types. The three cones are generally termed L, M, and S for Large, Medium, and Small, referring to the fact that the peaks of their spectral responses are at different wavelengths.

White light is a combination of various wavelengths. If we pass white light through a prism, we can see the various component wavelengths (see Figure 2). The component wavelengths range can be given by VIBGYOR (Roy G. Biv backwards), with V-violet having the lowest wavelength and R-red having the highest.

**Figure 2:**  
Prism splitting white light into its component wavelengths

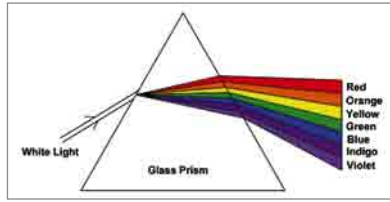

In general, white light can be produced using the three basic colors of Red, Green, and Blue. The question for developers is how to determine the right proportion of the basic colors to achieve white. Even if we arrive at the right proportion, in what units are we going to express it, so it is widely understandable and acceptable? The CIE (International Commission on Illumination, derived from its original French name) xyY color space is the most common answer for this. The xyY color space is built on the concept that any color can be represented fully by its hue, saturation and brightness/luminance in a three-dimensional color space. Though brightness and luminance are slightly different, we will ignore this difference for the time being. In the xyY color space, x represents hue, y represents saturation, and Y signifies brightness.

**Figure 3:**  
CIE chart

'Y' represents both the luminance and one of the coordinates.

To make things easier, these three coordinates (X, Y, Z) were further reduced to a two-dimensional space, with the definition of chromaticity co-ordinates (x,y) as

$$x = X / X+Y+Z \tag{2}$$

$$y = Y / X+Y+Z \tag{3}$$

So, the complete visible spectrum was represented in a two-dimensional space, named the CIE chart.

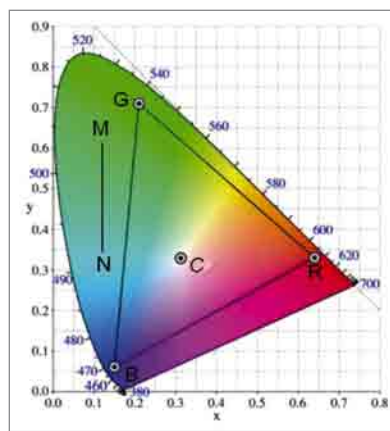

'Y', which is equivalent to luminance, can be imagined as being vertical to the (x,y) graph. Any color can be described by the (x,y) chromaticity coordinates and luminance 'Y'.

Before we further analyze the CIE xyY color space, let's briefly look at how it was arrived at. In the 1920s, extensive experiments were done on quantifying color. One such approach was to quantify and express color with three coordinates – R, G and B. Here, each value referred to the proportion of the 3 primary colors [R, G, and B] required for generating the specific color 'C':

$$C = R.R+G.G+B.B \tag{1}$$

R, G and B represent the primary colors and R, G and B signify the required mixing proportion of the primary colors to get color 'C'. However, this format had an issue where the coordinate 'R' was negative for a few colors. To overcome this, a new color space XYZ was defined, where X, Y and Z are imaginary primaries such that for all the possible colors, none of the co-ordinates are negative. In this new representation, color 'C' is X.X+Y.Y+Z.Z, where X,Y,Z and X,Y,Z are similar to R,G,B and R,G,B as defined earlier. In this system,

One critical property of the CIE chart is that any color on a straight line joining two colors can be produced by appropriately mixing the two colors at the endpoints of the straight line. For example, any color on line MN can be produced by mixing M and N in the right proportion. Extending the same logic to triangle RGB [with vertices as Red, Green and Blue color sources], any color within the triangle can be produced by mixing R, G and B in the right proportions. Considering this, let's treat the R, G and B color sources as LED light sources. Let the chromaticity coordinates of these LEDs be (x<sub>red</sub>,y<sub>red</sub>), (x<sub>green</sub>,y<sub>green</sub>) and (x<sub>blue</sub>,y<sub>blue</sub>).

If we wish to get color 'C' with co-ordinates (x<sub>mix</sub>,y<sub>mix</sub>) and with luminance 'Y<sub>mix</sub>', then the first task is to check if this (x<sub>mix</sub>, y<sub>mix</sub>) falls in the

triangle covered by R,G and B. Once we determine this, we need to calculate the mixing proportions of R, G, and B to achieve the desired color. By mixing proportion, we mean the dimming level required for the R, G, and B LEDs. There are many algorithms for these calculations. One such algorithm is the matrix approach, with the steps below:

1. Calculate matrix A as:

$$A = \begin{bmatrix} x_{red} - x_{mix} & x_{green} - x_{mix} & x_{blue} - x_{mix} \\ y_{red} & y_{green} & y_{blue} \\ y_{red} - y_{mix} & y_{green} - y_{mix} & y_{blue} - y_{mix} \\ 1 & 1 & 1 \end{bmatrix}$$

2. Make the inverse of matrix A:

$$A' = A^{-1}$$

3. Calculate the required lumen level for each of the R,G, and B LEDs as:

$$\begin{bmatrix} Y_{red} \\ Y_{green} \\ Y_{blue} \end{bmatrix} = A' * \begin{bmatrix} 0 \\ 0 \\ Y_{mix} \end{bmatrix}$$

Here, Y<sub>red</sub>, Y<sub>green</sub>, and Y<sub>blue</sub> give the required lumen output for each of the basic R, G, and B LEDs to achieve the desired color. This method has two advantages. If any of the Y<sub>red</sub>, Y<sub>green</sub>, or Y<sub>blue</sub> is negative, then it means that the requested color is outside of the gamut of the RGB triangle. Second, if any of Y<sub>red</sub>, Y<sub>green</sub>, and Y<sub>blue</sub> is greater than the maximum lumens of the respective LEDs, then the lumens of the final color, Y<sub>mix</sub>, is too large and needs to be scaled down.

Assume that we are using a PWM of resolution 'N' for dimming, then the signal density for the PWM driving the Red LED can be expressed as below, where Y<sub>max,red</sub> is the maximum lumens of the Red LED:

$$DimValue_{red} = (Y_{red} / Y_{max,red}) * ((2^N) - 1)$$

In summary, the requirement for generating any color within the triangle RGB is basic Red, Green, and Blue



LEDs with known (x,y) chromaticity coordinates and maximum lumens. Using suitable algorithms, we would have to calculate the dimming values for the R, G, and B LEDs to achieve the desired color. One such algorithm is the matrix approach we discussed earlier.

Logically, white light used for general illumination also falls within the triangle RGB and any shade of white light can be obtained by mixing R, G, and B sources in the right proportion. It is time to introduce another important parameter which is used to measure the chromaticity of white light, the CCT parameter. CCT [Correlated Color Temperature] is based on the concept on Color Temperature [CT]. Planck's law gives the intensity of the energy radiated by a black body as a function of wavelength and temperature. Therefore, every CT has a unique color associated with it, defined by its chromaticity coordinates (x, y). CCT is defined as the temperature of a black body radiator whose chromaticity is closest to that of the light source on a perceptually uniform color space. Figure 4 gives the black body locus on the CIE chart.

**Figure 4:**  
Black Body Locus on CIE 1931

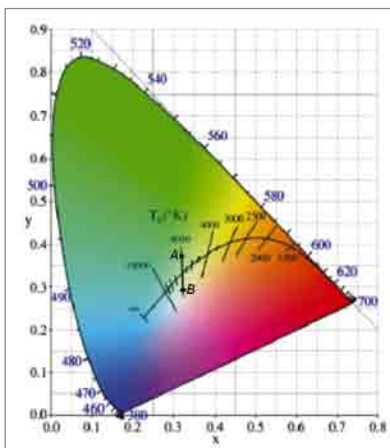

Note that a particular CCT refers to a line of chromaticity on the color space instead of a single color. For example, points A and B have the same CCT but different (x,y) coordinates. White lighting for general illumination usually falls in the range of 2,000 to 10,000K. So, the input parameters to a tunable LED white light system can be either

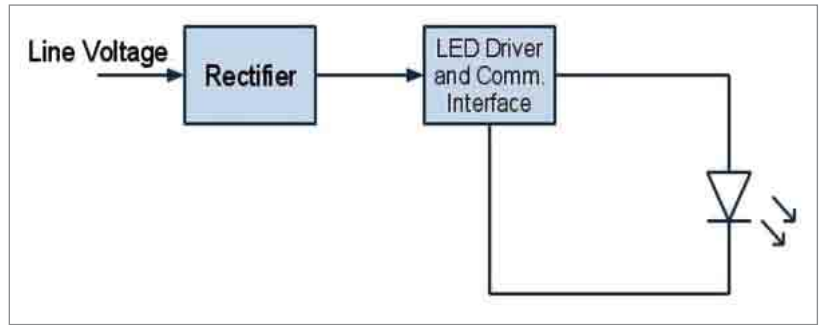

**Figure 5 :** Typical LED electrical system

the  $(x_{white}, y_{white}, Y_{white})$  coordinates or the expected CCT of the output white light. Based on this, the system has to calculate the required dimming levels for the component R, G, and B LEDs.

Figure 5 shows a typical electrical system for driving LEDs.

A rectifier is used to convert line voltage (AC) into DC. In general, the LED fixtures in home lighting/ architectural lighting are controlled from a common master and the fixtures are slaves. The common communication interfaces used in lighting networks are the DMX and DALI interfaces. In a tunable white light system, the master can communicate the expected  $(x_{white}, y_{white}, Y_{white})$  output to each of the slave fixtures through these communication protocols. Another option for the master is to communicate the desired CCT of the white light. It is then the job of the LED driver to calculate the  $Y_{red}, Y_{blue},$  and  $Y_{green}$  values and drive the LEDs with the calculated dimming values.

LEDs show variation in spectral properties with temperature. Effectively, this means that their (x,y) coordinates change with temperature. This can be critical in tunable white light applications, where the user would have set the dimming level for the R, G, and B LEDs to get a desired white color at a specific temperature. But, with variation in temperature, as the (x,y) coordinates of the basic LEDs changes, the output deviates from the desired color. As such, temperature compensation techniques have to be implemented in firmware with a real-time temperature feedback system, along with efficient heat sinks.

With LEDs, another design challenge is that they come in various bins, where LEDs falling under one specific bin exhibit similar spectral properties. When we procure a number of a specific color of LEDs from a vendor, they may not belong to the same bin and therefore produce slightly different outputs. The option for designers is to either procure LEDs under the same bin, which can be quite expensive, or compensate for this difference in firmware. This means the load on the LED driver in terms of firmware includes the actual color mixing algorithm, with the additional temperature compensation and binning compensation techniques. In addition, it can be an added advantage for many applications if the LED drivers support the DMX/DALI interfaces, as this enables a single-chip, cost-effective implementation.

There are many controllers well-suited for driving LEDs, with integrated MOSFETs, CSAs [Current Sense Amplifiers], hysteretic controllers, and other peripherals. Mixed-signal controllers also offer multiple modulation blocks like PWM, SSDM, and PrISM for controlling the dimming level of LEDs. A hysteretic controller, for example, takes the feedback from the CSA, Modulator block, and the Trip input. The trip input can be used to shut off the LED channel in case of any extreme current or voltage conditions. The calculated Y-red, Y-blue and Y-green dimming values can be fed as the signal density values for the modulation blocks controlling the Red, Green, and Blue LED channels. The CSA is used to monitor the current through the LED. The hysteretic controller output goes to the gate of

the FET, which acts as the controlling switch in a standard Buck or Boost converter. These controllers can support multiple 4 LED channels. Figure 6 shows the top-level set up for driving a single LED channel in buck configuration

The firmware for the mixing algorithm, as well the firmware for temperature compensation and binning compensation can be run directly on the controller. Furthermore, it can support the DMX/DALI interfaces.

In conclusion, giving the user an option to finely tune the white light source is becoming more of a requirement rather than a sophisticated value-added feature. Considering that in lighting fixtures, space is a major constraint, it is imperative that designers choose an LED driver which can implement a system using a single chip solution while also having the computational capacity to support complex mixing algorithms and seamlessly integrate them into existing lighting networks. ■

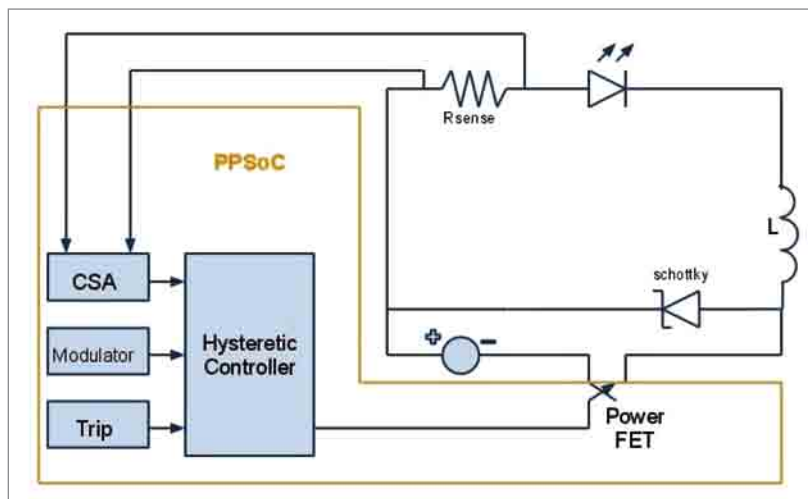

Figure 6: LED drive circuit using the PowerPSoC

PHOTONICS FESTIVAL in TAIWAN

**LED 2011**  
LIGHTING  
Taiwan

# LED Lighting Taiwan

The 7th Int'l LED Lighting Exposition  
[www.optotaiwan.com](http://www.optotaiwan.com)

June 14-16, 2011

TWTC Nangang Exhibition Hall

## Exhibits

- LED Lighting Fixture
- LED Applications
- Package / Module
- Epi Wafer / Chip
- Materials
- Processing Equipment

NEW!

Overseas VIP Buyer Scheme  
( Flight Ticket / Hotel Subsidies )

Organizer



Photonics Industry & Technology  
Development Association  
5F, No.9, Sec.2, Roosevelt Road, Taipei 10093, Taiwan

[ Overseas Contact ]

Tel : +886-2-2351-4026 (ext. 805)

Fax : +886-2-2396-8513

Pamela Hsiao E-mail : [exhibit@mail.pida.org.tw](mailto:exhibit@mail.pida.org.tw)

# Triac Dimmable Primary Side Regulated Flyback

Dr. Michael Weirich from the Fairchild Global Power Resource<sup>SM</sup> Center Europe explains that in lighting applications, high overall efficiency and power factor correction (PFC) are very important features not only at higher power levels, and also why a ballast design should have good EMI behavior and low cost. Furthermore, he describes a high power factor Flyback converter for LED lighting that implements all these features and can be dimmed with a standard TRIAC based dimmer.

Today's power LEDs are extremely efficient light sources. Manufacturers claim to achieve 200 lm/W and more in their labs and devices with about 100 lm/W, similar to the best linear fluorescent lamps, are available on the market. In parallel, the power handling capability of the LEDs has increased, and at the time of writing, multi-chip modules with a power of up to 100 W can be found on the market.

In lighting electronics international standards as EN 61000-3-2 make power factor correction mandatory for an input power above 25 W. The new Energy-Star directive for solid state lighting (SSL) even asks for a power factor (PF) of more than 0.9 for power levels above 3 W. While it's possible to achieve the latter value with passive PFC, it is desirable to have a cost effective solution that can achieve even better performance with low weight and small form factor. A Flyback converter controlled in such a way that input current is almost perfectly sinusoidal can be the most cost effective solution, if isolation between input and output is mandatory.

Besides high power factor there are more indispensable features of an LED ballast: high efficiency in order to get an overall efficiency comparable to CFL and long lifetime, that has to be as long as that of the LED itself. Finally, users would like to have the easy

dimability of incandescent lamps, using the already installed wall dimmers, a feature that is missing with standard CFL.

## Importance of Power Factor Correction (PFC)

An incandescent lamp behaves electrically like a resistor: its current is proportional and in phase with line voltage.

Switched mode power supplies on the other hand always have a rectifier at the input, followed by a reasonable valued capacitor, that filters and smoothes the rectified line voltage. Since current flow through a rectifier diode is possible only if the input voltage is higher than the voltage across this capacitor, there is only a short time frame where input current can flow. As a result, these short peaks must have high amplitude in order to transfer the energy. If the RMS value of this peaky input current is measured or calculated, it will be three to four times higher than it would be expected from the actual power consumption of the device. PF can now simply be defined as the quotient of real power to apparent power:

$$PF = \frac{\text{Real Input Power}}{\text{Apparent Input Power}}$$

Hence, the PF of the incandescent lamp is one while that of the example above can now be determined to be in the range of 0.25 to 0.33, far below that of the classic bulb.

At first glance the increased input current seems not to be too big of a problem, especially since energy meters measure the real power and not the apparent one. But closer analysis shows a lot of disadvantages of poor PF devices. Most important are the power losses caused by the additional reactive current in the distribution network. Since about 10% to 12% of electricity is used for lighting, it is obvious that increasing reactive current by a factor of 3 to 4 will considerably decrease efficiency of such efficient sources like CFL or LED.

Besides that, harmonic analysis of the non-sinusoidal input current shows a high harmonic content that worsens EMI behavior of the application. Since line harmonics cover the complete audible range, influence on audio equipment and generation of noise in inductors is very likely.

## Flyback Basics

For isolated power supplies up to about 100 W the Flyback topology is well accepted due to its relative simple, low component count construction, cost effectiveness and at the same time reasonable performance. The basic operation is simple and easy to explain with the help of Fairchild Semiconductor application note AN-4137 (<http://www.fairchildsemi.com/an/AN/AN-4137.pdf>). While the MOSFET Q1 is conducting, the current in the primary side of transformer T1 ramps up linearly and builds up a



magnetic field that stores energy. The polarity dots of the transformer indicate that polarity is such that the secondary side rectifier  $D_{Rect}$  is off during this time. As soon as the MOSFET is turned off, the polarities of all voltages across the transformer reverse, due to Lenz's law.  $D_{Rect}$  now starts to conduct and the energy stored in T1 is transferred into the capacitor  $C_{Filt}$ . Duty cycle of the PWM controller together with the winding ratio of the transformer determine the output voltage that is stabilized with the help of an isolated feedback network. The network  $D_{CL}$ ,  $C_{CL}$  and  $R_{CL}$  clamp voltage spikes due to the imperfect coupling between primary and secondary, the leakage inductance. This is important to reduce the voltage stress of Q1 but at the same time a source of power loss since the energy is dissipated in RCL.

**Figure 1:**  
Simplified schematic of a Flyback based SMPS

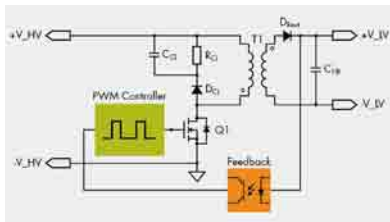
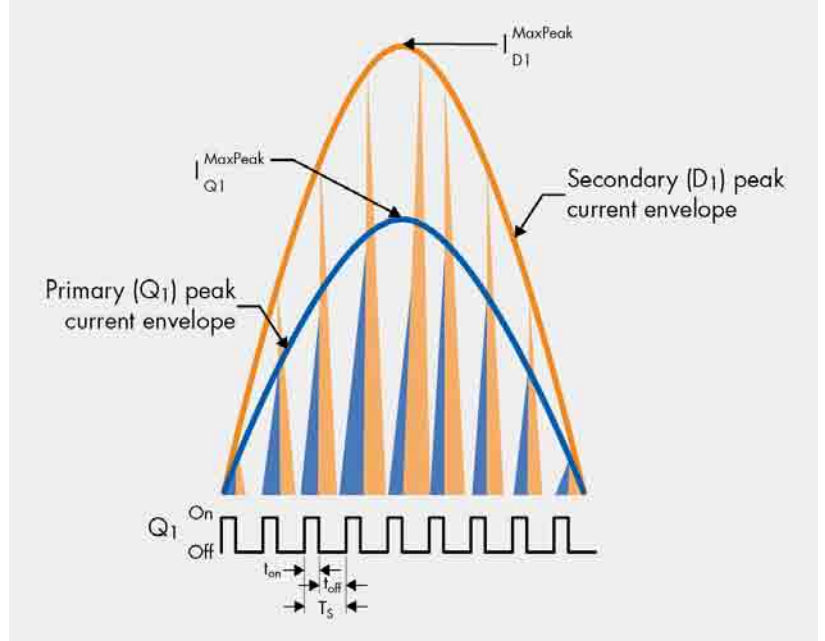

**Figure 3:**  
Converting a current mode PWM controller into a voltage mode one

In general, switched mode power supplies can work in two different modes: discontinuous conduction mode (DCM) where the MOSFET is turned on only after the current in the diode  $D_{Rect}$  has dropped to zero and continuous conduction mode (CCM) where it is turned on while there is still current flow in  $D_{Rect}$ . A third mode is sometimes mentioned: transition or boundary conduction mode (BCM) where the MOSFET is always switched on instantly after diode current becomes zero. As the name implies this mode is on the boundary between DCM and CCM.

**High Power Factor Flyback**

With the right control method and some changes in the input circuitry, the input current of a Flyback can follow the input voltage almost perfectly. Two different control methods are mainly used to implement such a high power factor (PF) Flyback. The first one is well known from literature and uses a BCM PFC



**Figure 2:** Timing and currents in DCM Flyback PFC

controller like the FAN7527. This approach needs a high VDS in order to achieve a PF close to 1 and suffers from the poor low load behavior of these controllers since they are not designed for this purpose.

The second, less well known approach is to operate the PSU in DCM with constant switching frequency  $f_s$  and a duty-cycle that is constant (at least) over one line half-cycle. With this approach, the power factor can, at least in theory, achieve unity without increasing  $V_{DS}$ .

Figure 2 shows the timing relationship during one line voltage half-cycle. Since the on-time of the MOSFET is kept constant, the peak value of the drain current perfectly follows the shape of the input voltage. Due to the constant  $f_s$  averaging of the pulsed input current (this is done by the EMI filter of the PSU) yields a shape that is proportional to the input voltage. Figure 2 also shows that the PSU almost works in boundary mode at the maximum of the line voltage while it goes deeper and deeper into DCM as the line voltage drops to zero. This method to achieve high PF can be implemented ideally with a voltage mode (VM) PWM controller and assuring DCM operation by choice of the transformer inductance. If a voltage

mode controller is used, input voltage as a reference for the MOSFET peak drain current is not needed. Since, on the other hand, current mode (CM) controller have so many advantages for standard off-line applications, it is difficult to find a state of the art VM controller for off-line applications on the market.

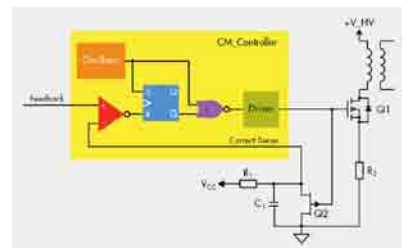

A solution could be to use one of the readily available CM controllers with constant switching frequency (e.g. the FAN6862) and use the input voltage as a reference for the peak current of the switch, exactly as is done in the PFC controller FAN7527. Like in the FAN7527, a multiplier would then be needed, since the sinusoidal reference has to be modulated with the feedback signal in order to regulate output voltage or current.

Fortunately there is a simple and easy implementation trick to make a VM controller from a CM controller. In both types of control the output of the error

amplifier is compared to a ramp signal in order to generate the PWM signal of the switch. In CM mode this ramp is generated directly from the switch current itself, while in voltage mode the ramp is generated by a built-in oscillator with a saw-tooth output. If the ramp signal applied to the current sense input of a CM controller now comes from a ramp generator instead of a shunt, the controller works exactly like a VM. Of course the ramp signal needs to be synchronized with the internal oscillator of the chip.

This can be achieved as shown in Figure 3 by removing the connection from R2, the current sense shunt, to the current sense input and adding R1, C1 and Q2. The latter is a self conducting p-channel JFET that ties current sense to ground as long as its gate and that of Q1 are drawn low. When the internal oscillator initiates a switching cycle the output of the controller rises to about 15 V, turning on Q1 and turning off Q2. Now C1 is charged via R1 from the supply voltage of the chip, applying an almost linear ramp to the current sense input. As soon as the ramp voltage hits the level set by the feedback loop, the PWM comparator switches and turns the gate driver. Now Q1 is off and Q2 on again, discharging C1. Obviously, the duty-cycle of each switching cycle depends only on the feedback voltage and not on the current through Q1: the controller works as voltage mode PWM.

## Quasi-Resonant Operation

The Flyback converter mentioned so far is a so-called "hard switching" one. That means that the MOSFET is turned off while the drain current is high and turned on while drain voltage is high. Since the falling / rising current and the rising / falling voltage overlap in each switching cycle their product is not negligible and there is considerable power dissipation called switching loss at each transition. In a DCM Flyback there is no current flow when the MOSFET is turned on, but the inherent capacitance  $C_{DS}$  of the MOSFET has to be discharged and the energy stored in this cap has to be dissipated. If one keeps in mind that the stored energy is  $0.5 \times C_{DS} \times V_{DS}^2$  it becomes clear that it is advantageous to turn on the MOSFET with as low VDS as possible.

In a hard switching Flyback operating in DCM it can be noticed that the drain voltage shows oscillations right after the energy has been transferred completely to the secondary and the transformer is de-magnetized. This oscillation is caused by the primary side inductance of the transformer  $L_p$  and the drain to source capacitance of the MOSFET  $C_{DS}$ . The Quasi-Resonant topology monitors the drain waveform and detects the minimum of this oscillation to switch the MOSFET on. With this method switching loss is reduced and can be reduced further at the cost of increased VDS when turned off.

Without going into much detail it can be said that traditional QR switching has the disadvantage of increasing switching frequency with decreasing load since the switching is synchronized too, with the de-magnetization of the transformer. The latter occurs the faster the lower the (load) current level is. Even if switching loss itself is reduced by QR switching, the high frequency operation at low load spoils loss balance under these conditions.

Consequently, state of the art QR controllers use an improved mechanism for the detection of minimum drain voltage. The FAN6300A, for example, has a certain minimum time of 8  $\mu$ s while the synchronization circuitry is disabled. Only after this time has elapsed, can the next drain voltage minimum be detected. The result is the detection of the umpteenth minimum drain voltage oscillation instead of the first one. If this minimum off-time is increased with decreasing the feedback level, i.e. decreasing load, it is even possible to decrease switching frequency with decreasing load current, resulting in excellent low load current efficiency.

## Primary Side Regulation

Due to their relatively constant temperature parameter and production parameter, dependant forward voltage LEDs should be driven with a constant current. This is usually achieved by some circuitry that senses and amplifies the output current driving an optically isolated feedback network as indicated in the simplified schematic of Figure 1. A standard way to implement this circuit is with operational amplifiers that need an additional stabilized supply voltage complicating the secondary side significantly. Irrespective of that, the opto-coupler is a component with reduced lifetime at elevated temperatures as they are observed in typical ballast applications.

This is a mechanism that omits the complex secondary side circuit and improves lifetime since an opto-coupler is not needed in the so-called primary side regulation. The latter uses

**Figure 4:**  
Quasi Resonant  
Switching

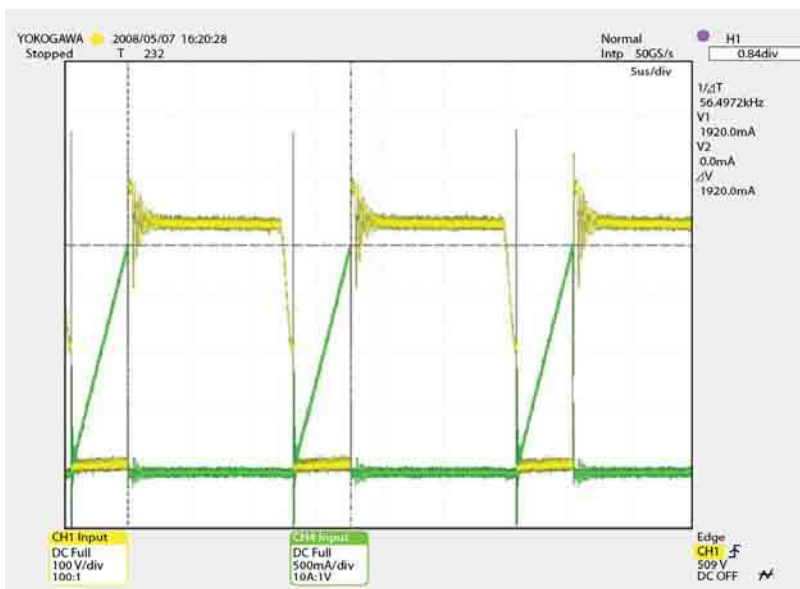

the fact that the ratio of two different output voltages of a Flyback is dominantly determined by the winding ratio of their respective transformer windings. If one of outputs, say the one that generates the  $V_{CC}$  for the PWM controller, is stabilized, the others will be relatively stable, as well.

If it comes to regulation of the output current, the situation becomes a bit more complex. Basic calculations show that the on-time of the MOSFET should vary with the square root of the load voltage, which is not easy to achieve. If the variation of the load voltage is limited to a smaller range, as it is in the case of an LED, a linear approximation to the square root is acceptable. How this is implemented becomes clear from the complete schematic.

### Putting Bits Together

The operation of the actual circuit can now be explained with the help of the complete schematic of Figure 5. On the left hand side the EMI filter and rectification are visible. The MOV at the input limits line surge voltage.

The capacitor after the rectifier (C102) has a relatively small value in order to guarantee the intended high PF.

Hence, the input of the actual Flyback is no DC voltage, but consists of positive half-waves with the shape of the line voltage.

The controller FAN6300A has an internal start-up circuit that can be directly connected to the rectified mains voltage. At startup C105 is charged to about 15 V and the controller starts to operate, while at the same time, the internal start circuit is disabled in order to limit power dissipation. When the controller is active and drives the MOSFET Q101, supply voltage is generated from the corresponding winding of the transformer via D103 and filtered by C111. Since the voltage across the latter winding is proportional to the drain voltage, the synchronization signal for QR switching can be generated from this voltage. As mentioned before, the input voltage varies from zero to the maximum line voltage, and the sync signal does, as well. The network R105 & D107 generates a stable signal over the complete half-wave.

The output voltage is stabilized with the network D104, R101 and Q103, while C107 is for frequency compensation of the feedback loop.

When the ballast operates in constant current mode the voltage at the feedback pin is limited by R109.

The circuitry that puts the controller into voltage mode is visible on the lower right. Other than shown in Figure 3, the capacitor is charged by a current source that increases charge current when the output voltage, and in turn,  $V_{CC}$  drops. That gives the linear drop of on-time with output voltage, approximating a constant current output very well. The switching frequency is 100 KHz, allowing the power to be transferred with an EF20 type transformer.

Network R111A, R110, C108 and D106 implements an over-current limit for Q101 and is inactive during normal operation.

There are two outputs on the secondary side: one for driving the LED module having 14 V / 1.4 A and the second with 5 V / 0.2 A for a fan integrated to the LED's heatsink, giving a total output power of 21 W.

It has already been mentioned that duty-cycle has to be virtually constant over the line half-cycle, i.e. the feedback loop must have a slow

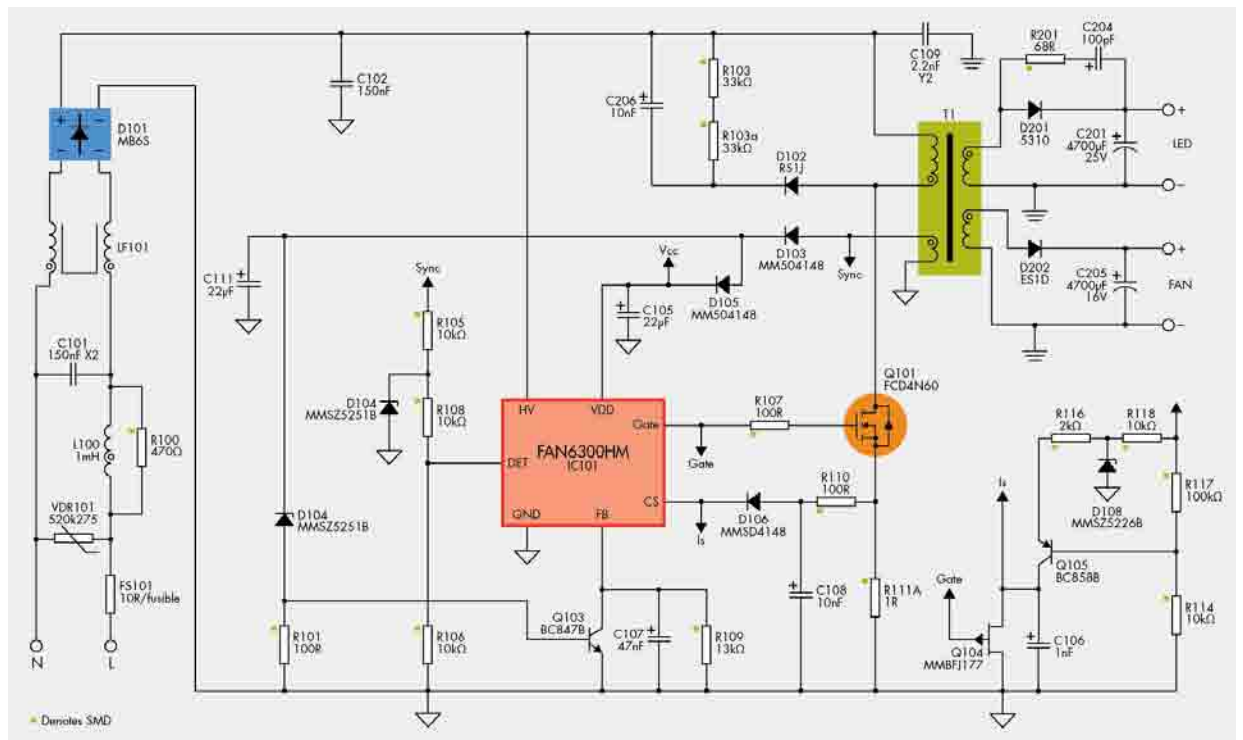

Figure 5: Complete schematic of high power factor dimmable LED ballast



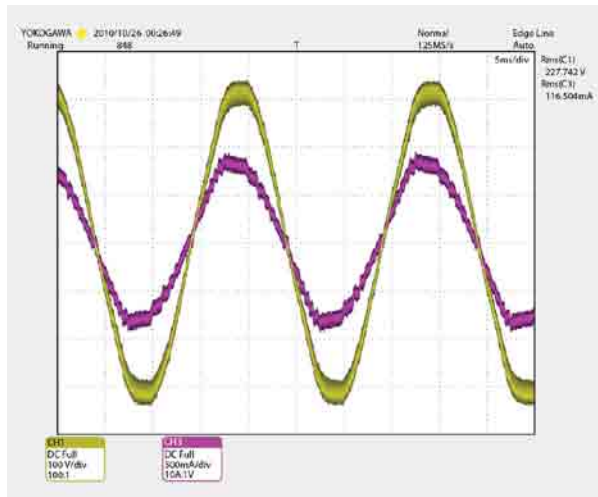

Figure 6: Input voltage (CH1) and current (CH3) of the ballast

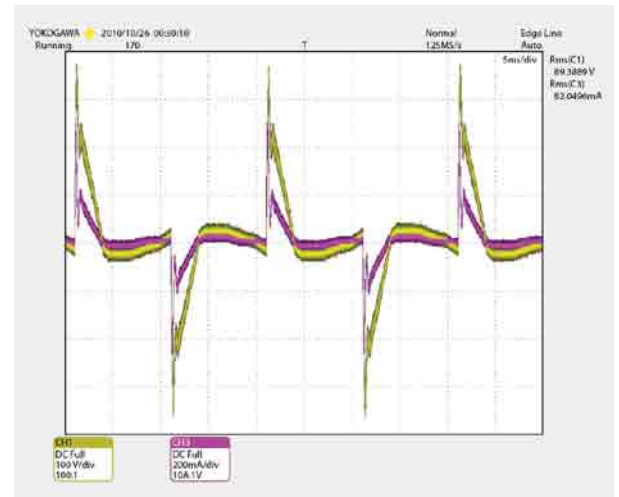

Figure 7: Input current and voltage with TRIAC based dimmer

response with a corner frequency below about 25 Hz. This is achieved by relatively high values of C105 and C111. The slow loop response is not an issue at all since the LED is not a very dynamic load.

The ballast has been assembled on two PCBs that fit into a cylinder measuring 48 mm in diameter and 42 mm in height. This PCB was designed to be fitted directly to a Nuventix MR16 heatsink.

With 230 V<sub>RMS</sub> input and 21 W output power an efficiency of 85% has been measured. Due to the relatively high output current the secondary side rectification is one of biggest sources of power loss. If the ballast is re-designed to work with higher output voltage and lower current, efficiency will increase somewhat.

The power factor was measured to be 0.98 and a THD of the input current of 7% was measured. A scope shot of input voltage and current is shown in Figure 6.

## Dimming

Since the ballast is running in voltage and having a specific feedback loop, output power is proportional to the RMS input voltage. If the latter is reduced then output power, or rather, the brightness of the LED, is reduced as well.

The ballast has been tested with many different electronic dimmers so far. So called 'Tronic' or 'Phase-Cut-Off' dimmers that are intended for use with electronic transformers for halogen lamps work excellently, since the switching element in these dimmers is not a TRIAC and doesn't rely on a certain hold current.

Many of the standard TRIAC based phase cut dimmers also work well although the situation is more complex. Since TRIACs need a certain hold current that is related to the minimum controllable power, those dimmers that have a low minimum power of, for example, 20 W are better suited than ones with a high value. This is not really different from the use

of incandescent lamps with TRIAC based dimmers. But since a 20 W LED may replace a 75 W incandescent, trouble with the built in dimmer that is rated at a 50 W minimum load may arise.

A second problem that may arise with some dimmers is due to the ringing of the input filter together with C102 that may cause faulty turn-off and re-triggering of the TRIAC. In this case a damping network consisting of a resistor of about 470 Ω / 2 W in series with a 100 nF / 400 V film capacitor will help. This network should only be added if necessary since it dissipates some power and worsens efficiency.



## LED Waterproof Wall Light WL-030-AW-01

As the global leading manufacturer of flexible LED strips, Signcomplex has developed a new Waterproof Wall Light for solid state LED lighting. WL-030-AW-01 features IP66 waterproof, lighting both two sides. Its power consumption is 30W, input voltage is 100-240V, lumen output is 1108lm for warm white and 1342 for cool white. Both sides have 6 LED and its lens is 45 degrees.

It has a bracket to be mounted onto walls, and can be widely used in hotels, homes, landscapes, parks, to highlight the architecture outline and texture, and render a magnificent appearance.

For more detailed technical and sales information, please contact SignComplex sales team.



www.signcomplex.com

# guangzhou international lighting exhibition

广州国际照明展览会

The biggest lighting industry forum in Asia

16<sup>th</sup>

9 – 12 June 2011

China Import and Export Fair Complex  
Guangzhou, China

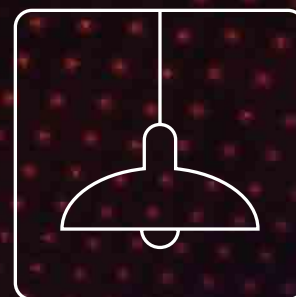
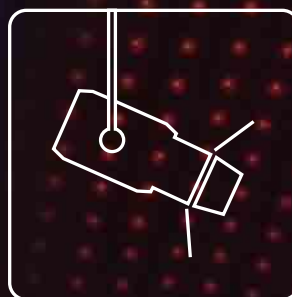
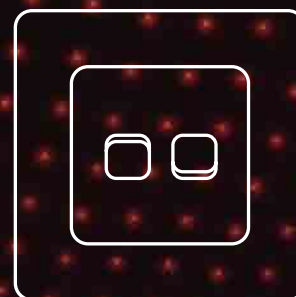
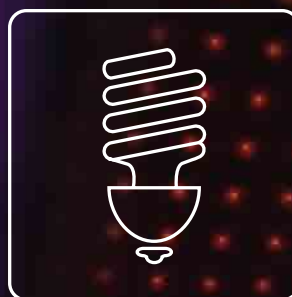
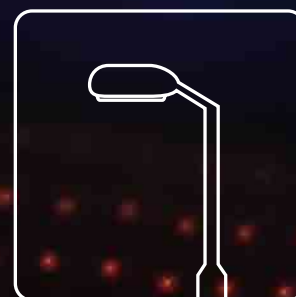

#### Contact

Messe Frankfurt (HK) Ltd

Tel: (852) 2802 7728

Fax: (852) 2598 8771

[LBguangzhou@hongkong.messefrankfurt.com](mailto:LBguangzhou@hongkong.messefrankfurt.com)

[www.light.messefrankfurt.com.cn](http://www.light.messefrankfurt.com.cn)

# Facts about Dimming

Over 95% of the existing residential and commercial electrical dimming infrastructure are single channel wall dimmers. Gregg Sheehan, IP / R&D Engineer at Light-Based Technologies explains why it is crucial to serve the market with high quality solutions and how to solve the upcoming challenges.

This article is intended to address “direct” phase-cut dimming of LED fixtures and does not include the wide range of network type dimming systems such as DMX, DALI, 0-10 or 1-10VDC style control networks or theatrical methods. This is primarily because there has, to date, been much written discussion on the use of LED fixtures in network control, yet less that addresses the larger part of the dimmed lighting environment – namely the use of the ubiquitous single channel wall dimmer that makes over 95% of the existing residential and commercial electrical dimming infrastructure. Those acquainted with the subject matter are familiar with the need to maintain power factor, efficiency and stable operation but the challenges to achieve these goals are less well understood.

**Figure 1:**  
Phase cut dimming types  
Achieving “Good Dimming” with LEDs

In short, single channel phase-cut dimmers are a significant part of the existing lighting landscape and show no signs of going away. In fact, sales of these dimmers continue to increase. According to studies done almost 9 years ago there were 4-billion incandescent lamps in the US alone with estimates of over 150 million traditional dimmers installed. The forecast is for these to continue to increase in numbers well into the future and be installed into buildings and homes world-wide. The impetus behind this continued adoption is two-fold – a desire for increased illumination aesthetics in increasingly upscale residential/commercial environments and the possibility for “energy savings” via dimming. As the

various “green-mandated” world governments move towards legislating traditional incandescent/ fluorescent fixtures out of existence, these same sockets will ultimately be populated with LED lamps as replacements. This latter point needs to be underscored as the lamp fixture most likely replaced first in a given installation is the one that creates the most value, and of these, many will likely also be connected to some form of single channel dimming solution or controller. The existing wall dimmer with an incandescent lamp works quite smoothly and looks very appealing. It is aesthetically pleasing and economical in its implementation. This is the benchmark LED dimming needs to hit and then surpass, to be fully embraced by the end user. Unfortunately, dimmed LEDs often do not fare so well. Substantial power savings alone can’t make these facts invisible to the end user who is looking to re-create the effect and response of their existing lighting infrastructure. The fact that the US Energy Star criteria offer as a solution a request that LED lamp suppliers provide a list of suitable dimmers for their lamps is sufficient evidence that the compatibility of LED with existing dimming technology is far from perfect.

The two major types of phase-cut dimmers used today (so-called because they remove or cut, selected portions from each AC half-cycle wave) are leading-edge dimmers (LEDIM) and trailing-edge dimmers (TEDIM). See Figure 1a, b and c. LEDIM seems to be prevalent mostly in North America. TEDIM is very popular in the EU/ and the rest of the world, supposedly working better with low- voltage halogen lamps using electronic

transformers. LEDIM usually employs a simple Triac or Triac/DIAC as the active element, while TEDIM has generally more complex circuitry and utilizes MOSFETS or IGBTs as the active device(s). LEDIM could be said to be Active State ON and TEDIM to be Active State OFF, relative to a zero degree starting point, per 180 Deg or half-wave. It is fair to say that there is slightly less inherent noise produced by TEDIM, as RF and EMI from TEDIM’s active state, as it is switching off, rather than on, with less overshoot and resultant high frequency noise.

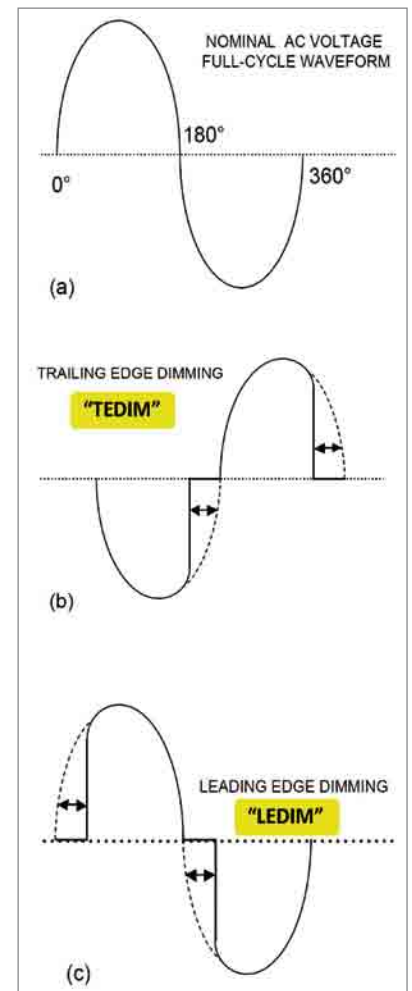



**Figure 2:**  
PWM resolution  
at low dimmer  
settings

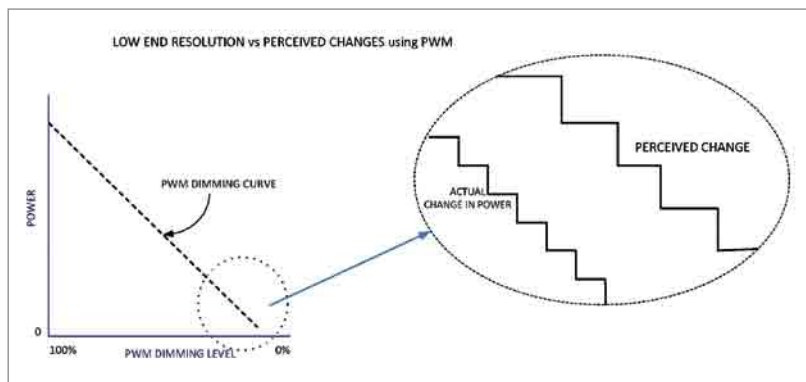

The lighting industry, inclusive of LED fixtures and lamps, generally has clearly defined electrical standards, properties, life expectancy, temperature and light distribution standards, which are defined and endorsed by the third-party certification industry, (including the IES LM-79 and LM-80 (now referenced by DOE as Energy Star™)). It does not, however, have the same definitions and standards for actual dimming performance over the dimming range.

The practical benchmark in the industry is still the behavior of a typical dimmer with an incandescent load. This response just appears to be “right” to the average user’s eye/brain-response (psycho-visual perception) to be fairly linear and smooth in performance. This smooth flicker-free dimming response is beneficially assisted by thermal inertia of the filament in the lamp and visual persistence in our vision system. The relationship between lamp output optical power and our visual response is in fact a log curve for an incandescent lamp running from a 100% light level down to a 0% light level. However, when many LED fixtures are dimmed they can shut off completely at around 10% to 20% light level on the dimming scale due to practical limits imposed by their power supply minimum-voltage requirements. Furthermore, at low power levels there can be a transition region in the dimming process/range which causes flickering or visible transitions, as the LED goes through increasingly larger steps such as in a standard Pulse Width Modulation (PWM)-type system. The PWM steps are the same size but our visual perception makes them

larger (shown in Figure 12) as a comparison between perceived light levels vs. absolute power/light levels. Compared with the ideal, this is visually distracting and unacceptable.

Consider restaurants: They are the quintessential dimmer users, with the business norm being that lighting is in some dimmed mode, usually within the bottom 20% of the full-light level, to create the traditional intimate dining experience. They use a nearly theatrical approach, to create areas of high luminance contrast ratios by having a low level background between tables with often a highlight lamp or central candle placed on the table to create pools of lighting. After closing and during the day they may also require 100% lighting levels for cleaning, and next day preparations. Also consider movie theatres. They have a clearly defined need for safety- mandated, minimums and maximums, as well as building code requirements. This low level “norm” area, is where PWM-style dimming starts to show it’s warts, as it starts running out of bits and acts in a large “step” transition mode, resulting in flicker and unsmooth light changes (see Figure 2).

The most elegant solution for dimming is the use of intelligent linear control. This method offers compatibility with virtually all dimmer types and manufacturers, and greatly simplifies the compliance under Energy Star™ with the ability to dim smoothly throughout the full range. Energy Star™ currently has no specific requirements other than listing which specific equipment makes and models that will work together successfully.

A further refinement and advantage of one such proprietary approach offered by Light Based Technologies is the ability to scale a lamp’s response in a programmable way that enables finer, repeatable control over a specific area of the entire dimming range. This ability to change modes, while using a standard third-party dimmer is made possible by detecting changes in the dimmer control when doing short, repeated or specific motions. For example, a quick up/down, done in under a second, flips the mode to a different preset mode, such as Mode “B” or 40% maximum light level at full fader or full clockwise and counter-clockwise rotation of a control. Figure 3 shows how the actuation of this proprietary “Deep Dimming” feature creates a magnified dimming resolution at the bottom of the dimming range such that the bottom 20-50% of full range is spread out over the entire electro-mechanical adjustment range. This is irrespective of the user input device or dimmer and allows for much finer control of settings that operate normally in a low dimmed setting. The control interface may be a rotary potentiometer, linear fader, capacitive sensor or “touch” type user- interface.

Another set of solutions in this application of intelligent linear control, is the ability to have multiple actual-performance curves available, including logarithmic, linear and custom variants. They are selectable by a similar method, shown above. Figure 3 shows three sets of “S”-type or incandescent-style performance curves for example, with a different maximum level on each. Mode “C” for example would be ideal for restaurant use during business hours and Mode “A” would then be enabled for both after-hours cleanup and the morning prep. Mode “C” would allow the management to really fine-tune the exact atmosphere they desire for their business, by manipulating the light levels throughout a room.

Another aspect of linear control is that the current is generally fixed at a lower level than with PWM, which operates by varying duty cycle and thus average current, over the same  $\Delta V$  as linear

**Figure 3:**  
Magnified dimming range

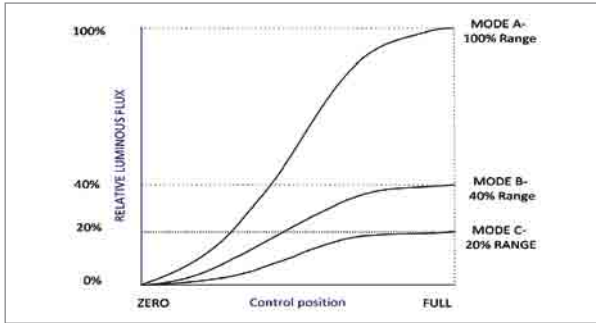

**Figure 4:**  
Current versus voltage

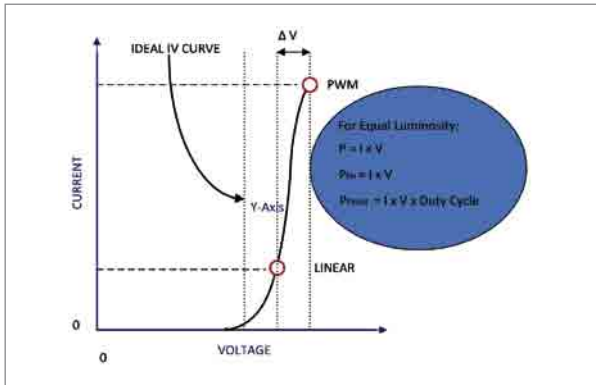

**Figure 5:**  
Typical “Droop” in output for LEDs as a function of forward current. (Source: Candlepower forums)

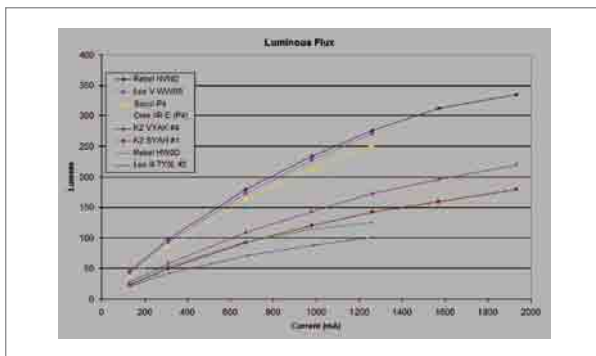

**Figure 6:**  
Comparison in output efficacy at low dimmed levels for dimmed PWM versus linear (Luxeon Rebel Data)

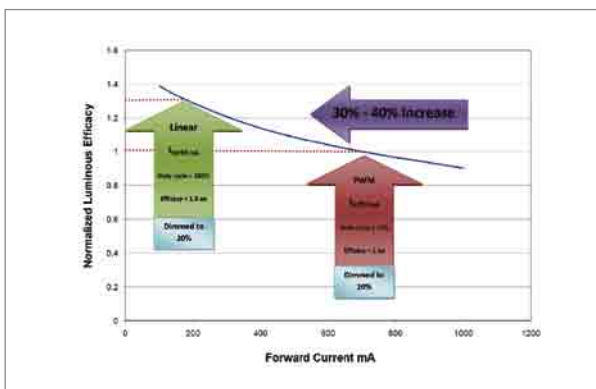

**Figure 7:**  
Advantage of linear secondary side control

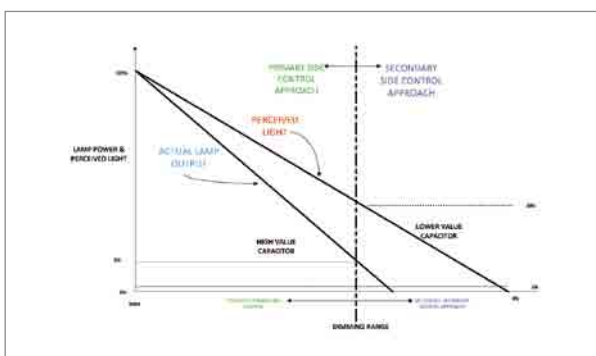

operates. The net result is less power consumed and greater efficiency with linear controls characteristic reduced forward voltage (see Figure 4).

The use of intelligent linear control as an overall control technique shows further advantages, particularly when applied to low level light-dimming applications. The well-known LED output “droop”, inherent at higher currents is not present by virtue of the true reduction of instantaneous junction current. This effect is significant in that it represents up to a 30 to 40% improvement in overall efficacy as the lamp is dimmed (see Figure 6). This mode of operation also delivers optimized energy efficiency through most dimmed light levels when compared to traditional PWM approaches. Figure 5 shows the “droop” (departure from linearity) for a wide variety of popular LED manufacturers for luminous flux versus forward current, at constant junction temperature.

Figure 6 offers a more focused analysis on efficiency. It clearly illustrates the change in overall efficacy of a typical Luxeon™ Rebel LED operated between PWM and linear operation at a typical 20% electrical power dimmed level. Here the effect of current droop is significantly more apparent in the overall LED efficacy (assuming constant junction temperature). Both systems are dimmed to an effective 20% electrical power level while the efficacy of the linear dimmed system (100% duty cycle, 150mA) is 30% higher than that of the PWM dimmed system (20% duty cycle, 750mA).

### Linear Control

Most switching-type power supply (SMPS) or LED driver topologies involve designs with separate primary and secondary “side”, or sides as in the case of multiple output supplies, and these are usually electrically/ physically separated by a transformer or fly-back inductor.

Nearly all major semiconductor companies making power supply or LED driver control IC’s, espouse the very same technique of primary-side control. However, the direct secondary-side control of power supply or LED drivers has many practical advantages, as shown with the LB4 technology from LBT.

As visible in Figure 7, it can be seen that with PWM control topology, the perceived light output is still at 20% when the actual power is dimmed to 5%. The linear approach goes very near to zero perceived light output, when the actual power is reduced to zero. This would substantiate the common PWM product specifications claims of dimming from 100 to only 10%.

As can be seen, the relationship between measured light output power and the perceived amount of light is quite linear, with an exponent of 0.5, from Stevens’ Power law.

LBT also uses a patent pending method to send time-relevant control info from the primary to secondary sides, which enables low delay or real-time control. Having the



## Ledlink Optics, Inc.

With integration of optical design, mould tooling, and mass production in house, Ledlink offers professional optical solution and various types of semi-module products.

Our mission is to provide just in time services along with cost effective and optimised performance secondary lens for innovating LED lamps.

Please contact us for further information or visit our website for our latest products.

Street light in China Shandong



Asian Olympic Games in China Guanzhou



Trade center in China Sichuan



Stage lighting & acoustic exhibition in UK



Bridge lighting in Poland



[www.ledlink-optics.com](http://www.ledlink-optics.com)  
[service@ledlink-optics.com](mailto:service@ledlink-optics.com)  
 T: +886-2-8227-6126  
 F: +886-2-8227-6127

Single Lens



Multi Lens



Street Lighting Lens



Asymmetry Lens



Convex Lens



COB Lens



**Certification :** ISO 9001 ISO 14001 UL:E335300 RoHS



**Figure 8:**  
Linear dimming  
comparison chart

direct load controller on the secondary side, also allows accurate delivery of load current and minimum voltage, and only when required. The differences, shown in Figure 7, include low-end resolution, less capacitance required from improved regulation, etc. Two well-known controller IC manufacturers have successfully reached 0.1%, as in one case, with the inclusion of large value capacitors, with their low MTBF, higher cost and size issues. Another manufacturer achieves this by ignoring electrical isolation requirements.

### Dimmer Holding Current

Another factor to consider for proper dimmer interoperability is that all leading edge-type Triac-based dimmers (LEDIM) require a holding current due to their internal electronic component's internal architecture and behavior. In short, they will shut off completely when current stops going through them, causing the light to flicker or even turn off during this time, depending on the driver's ability to restart. This of course, occurs periodically, every time the AC waveform approaches or leaves the zero-voltage region.

In many designs, a holding current can be simply created by a small, simple resistor load, but this is a fixed value active throughout the entire waveform duty cycle, which unnecessarily wastes energy. A truly efficient holding current circuit is a solution, which is only turned on when there is insufficient load current and in an appropriate minimum amount and at the particular time for the load and dimmer current requirements. This requires a design which is both dynamic and periodic, to perform the function efficiently, such as the proprietary LBT Holding Current design. This is a practical solution as Triac holding current requirements do vary substantially, according to the Triac component wattage, semiconductor materials variations and the OEM manufacturers' internal component construction.

Figure 9 shows a Spice simulation illustrating both the dynamic and periodic response of Light Based

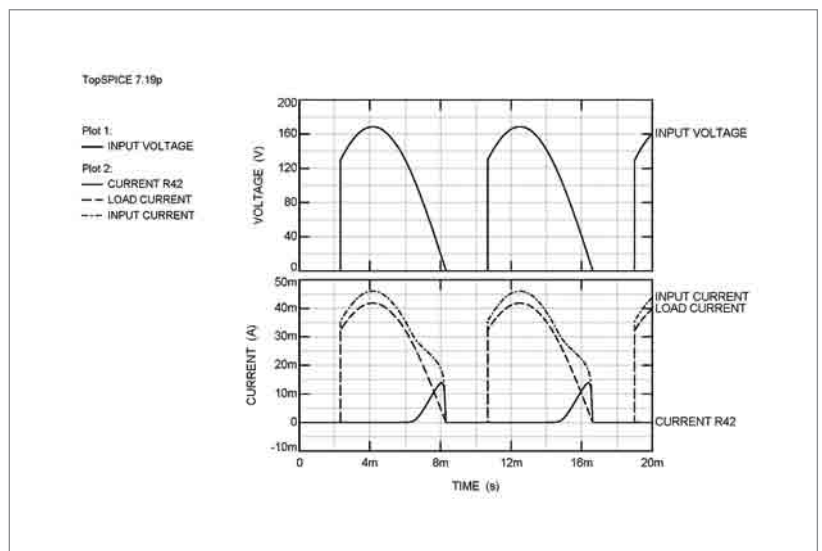
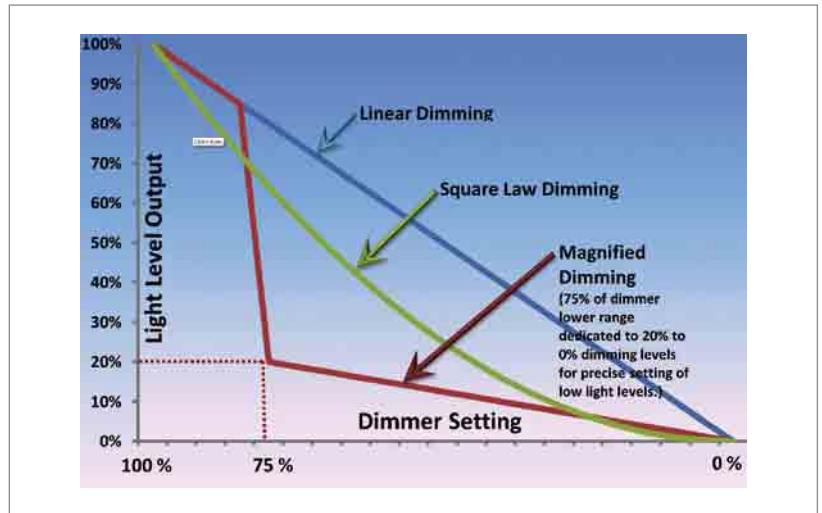

Technology's approach. The actual amount of dynamic holding current (Current R42) is actively determined by both the load requirements and the requirement of the individual Triac or semiconductor dimming device. The portion of duty cycle from approximately 8 to 11 ms has a suitably low impedance and very small current, in order to suit the Triac minimum requirement. A LEDIM-type dimmer AC half-wave waveform is shown at top for reference at approximately 25% dimming from full, measured post bridge-rectification, but pre-filtering.

Trailing edge dimmers or TEDIM also require holding currents but for different reasons. The active devices are usually MOSFETS or IGBTs. The devices will also stop working properly when there is no voltage drop across them, which also happens periodically

during the waveform. The off-transition will have a slightly gradual slope rather than a near instantaneous slope. The result is that all dimming behaves poorly without a suitable holding current, leading again to the need for a dynamic holding current to deliver smooth operation and maximum power efficiency.

### Power Efficiency

Every element of an LED lighting system has its own efficiency figure and to date there is no such thing as 100% efficiency. Every component in the system has an energy loss including the driver/ power supply, the LED itself, the optics (lenses or diffusers), and reflectors (where used) and of course, poor thermal management, which can cause a gradual change, usually downward, in luminous output produced at the LED gap itself, over time.

As a consequence, when any of these specific components enjoys an increase in efficiency, even in the range of single-digit percentages, the contribution to overall efficiency is significant. Due to the relative cost differences in technology and the relative immaturity of LED fixture development and productization, engineers are more motivated than ever, to make as many improvements as possible; more so than the humble, and soon-to-be-obsolete, incandescent/ CFL fixtures enjoyed during their own development cycle.

In general terms, power supply/driver units may be characterized for efficiency, by:

$$W = P_{out} / P_{in} \text{ or } W = V * I_{out} / V * I_{in}$$

In simple terms, the driver efficiency is:

$$\text{Efficiency [\%]} = P_{out} * 100 / P_{in}$$

The LED efficacy: lumen/W

The lens refractive index or general transparency percentage (t[%]):

$$n = \frac{\text{velocity of light in vacuum}}{\text{velocity of light in medium}}$$

or

$$t[\%] = I_{m \text{ out}} \times 100 / I_{m \text{ in}},$$

respectively, and the reflector efficiency from

$$\frac{I_{m \text{ out}} (\text{incidental}) \times 100}{I_{m \text{ in}} (\text{incidental})}$$

Considering system efficiency throughout the dimming range is a necessary consideration. Does a modern Triac-type dimmer, used for LED and drivers, have an efficiency specification? Good question! Old-fashioned dimmers used loss resistive elements while modern dimmers are more like triggered switches, particularly the MOSFET-type. Still, nothing is perfect and everything has some ESR (electrical series resistance) which wastes power by producing heat. During normal operation, dimmers do get warm to the touch. Phase-cut dimmer electrical efficiency is typically around 99%. The other 1% is dissipated in the dimmer as heat. So a dimmer on a 600W load

would produce around 6 watts of heat, and a 1kW load producing 10 watts. UL/CSA -specified temperature limits on surfaces dissipating this waste heat is typically 140F (60C) degrees.

### The Importance of Power Factor

Power Factor refers simply and in a perfect world, to the degree to which the voltage potential and current draw required by the load, are in-phase or co-incident, for each half-cycle of the sinusoidal AC waveform. Both should happen at the same time, much like in a purely-resistive load does. It is defined as real power over apparent power. The “type” of load can cause the current to lead or lag in time, relative to the voltage waveform time-base (see Figure 10).

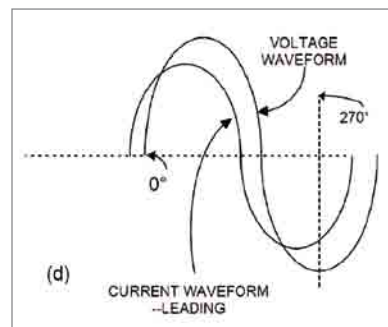

Dimmers of both styles have a major effect on Power Factor, for all types of loads (capacitive, inductive, resistive, Linear, non-linear and combinational/or complex). This is because it is typical to cut voltage phase over the current peak in the same area as required by the load causing imbalance and harmonic distortion on the AC line (see Figure 11).

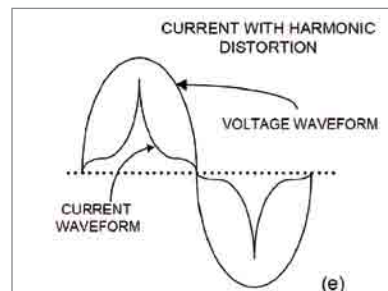

“Distortion power factor” describes how the harmonic distortion of a load current decreases the average power transferred to the load.

Distortion power factor (DPF):

$$\text{DPF} = \frac{1}{\sqrt{(1+\text{THD}_i^2)}} = \frac{I_{1\text{rms}}}{I_{\text{rms}}}$$

THD<sub>i</sub> is the total harmonic distortion of the load current. This definition assumes that the voltage stays undistorted (sinusoidal, no harmonics). This simplification is often a good approximation in practice. I<sub>1rms</sub> is the fundamental component of the current and I<sub>rms</sub> is the total current; where both are root mean-square values.

$$\text{PF} = \text{DPF} \times \frac{I_{1\text{rms}}}{I_{\text{rms}}}$$

The result when multiplied with the distortion power factor (DPF) is the overall, true power factor or just power factor (PF).

Poor power factor is rarely evident to the residential end-user however the commercial/ industrial-level user may pay additional surcharges. If their load is highly inductive, for example, they may have to install capacitor switch banks to compensate for this power loss. At the residential level, the utility company must spend money on hardware and additional power to correct for this imbalance throughout their distribution system.

LED drivers and switch-mode power supplies (SMPS) are considered to be non-linear or complex loads and require power factor correction (PFC) to reduce the non-sinusoidal current distortion they create, from having excess energy at harmonics of the line frequency of the voltage (see Figure 11).

The EU standard EN61000-3-2 regulates harmonic content and basic PFC criteria for all SMPS. Passive PFC in LED drivers/power supplies usually involves adding capacitors, resistors and steering diodes, such as “valley-fill” circuits. Active PFC also involves redistributing the current over the voltage half-cycle waveform. The problem to solve is how to improve load regulation without adversely affecting PFC or make the load look like a linear resistor. The typical technique is to utilize a 2-stage supply/driver topology such as boost, buck or buck-boost.

**Figure 10:**  
Example of current waveform leading the voltage waveform

**Figure 11:**  
Distortion Power Factor waveforms caused by non-linear/complex loads

LBT's new proprietary power-supply/ LED driver currently under development utilizes a radical new topology to improve Power Factor performance and efficiency.

### Power versus Perceived Light

The relationship between actual dimming (light reduction) and perceived dimming (human perception of light reduction) is logarithmic by nature (see Figure 12). Dimming to say, 25% of the original full light output is perceived as approximately 50% dimming and so forth. That being said, a typical dimming amount of 3 to 5 % dimming shows up on the last little bit of fader or rotary control adjustment is hardly ideal. A narrow dimming range is barely perceived. Human perception of audio behaves in a similarly logarithmic way, where larger amounts of power and change proportional to

that power are required, in order to be perceived. Modern LED technology in retrofit lamps can just barely achieve the high level of brightness and quality that is acceptable for the mainstream market. Much work remains to push the envelope of brightness, power, efficiency and thermal management for commercially acceptable products.

The good news is that strides continue to be made in this direction and LBT is happy to be on the cutting edge of innovation, in this truly exciting field.

On the most pragmatic level, dimming LED lighting saves money, in several ways. This happens from reduced direct electrical consumption and reduced maintenance or replacement costs, through to increased lifespan of the light fixture, itself. Every dimmer automatically saves 4-9% in electricity-even at the highest lighting levels-over a standard on-off switch. And when

users choose to dim their lights, even more electricity is saved. Due to Triac triggering characteristics, they do not turn on exactly at the zero crossing of the AC waveform and there is a small amount of phase cut occurring, until that voltage threshold is reached, even at the fully-on setting.

A summary of aesthetic performance attributes for high performance LED dimming would be: Controllable dimming range, programmable dimming curve, smooth transitions, good starting and warm-up, stable light level throughout the adjustment range, stable color or programmable color shift during dimming, low acoustic and EMI noise, control/ user input flexibility, good Power Factor and pleasing, comprehensive color control.

Good technical performance attributes for high performance LED dimming are: wide-range AC input operating voltage, wide input waveform acceptability, highest efficiency possible, flicker-free and step free low range performance, no cut-out, smooth full-range operation from 0 to 100%, low harmonic distortion (THD), good Power Factor, low-EMI and RF generation, minimum voltage operation, current regulation and low inrush current.

Dimming LEDs, like the less-efficient CFL, is difficult. Through careful explicit design, they can be made to perform identically, to what the end-user is familiar with, using traditional incandescent phase-cut dimmer controls. ■

**Figure 12:**  
Perceived light level versus absolute power/light levels

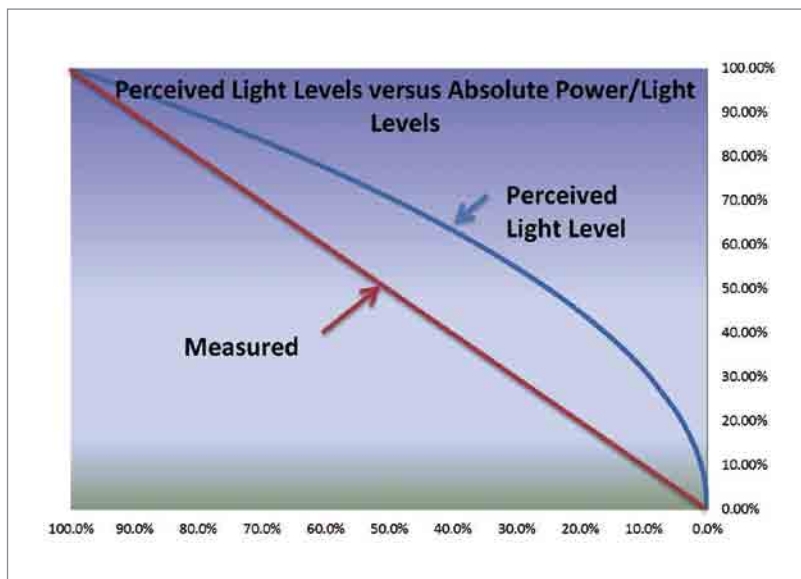



# LED LIGHTING SUMMIT EUROPE 2011

MAY 4-5, 2011, NHOW HOTEL, BERLIN, GERMANY



**Increase the diversity, efficiency and profit from your lighting products with the full commercialisation of LED technology**

**Expert insight**



Paolo Bertoldi  
Principal  
Administrator  
European  
Commission



Geert Van Der Meer  
Global Product  
Marketing  
Manager  
Philips



Albert Studerus  
Global Head  
of SSL  
OSRAM



Tom Van Den  
Bussche  
Marketing  
Director EMEA  
Bridgelux



James Marsh  
Electrical  
Engineering  
Manager  
Tesco

- **EVALUATE LED LIGHTING SPECIFICATIONS:** Including Performance, Lumens/Watt, Heat-sync developments, Availability, CRI and Colour temperature and understand how developments will revolutionise your lighting portfolio
- **HEAR FROM END-USERS FROM ALL SECTORS:** Including retail, public/outdoor, commercial and industrial. Understand what you need to be supplying and what brings the highest revenue
- **CONTROLS, SYSTEMS AND OPTICS:** Ensure you are using the most compatible equipment to get the best efficiency, brightness, colour, angle and temperature performance from your LED modules
- **UNDERSTAND THE NEED FOR STANDARDISATION:** Explore regulatory guidelines, policies and incentives, ensuring you stay ahead of the game when it comes to ultra-efficient lighting
- **GLOBAL LED OUTLOOK:** Understand how international LED manufacturers are adapting, where the biggest markets are and where the future looks brightest

THE BEST QUALIFIED  
SPEAKERS SHARING  
THEIR KNOWLEDGE AND  
EXPERIENCE WITH YOU!



**Expert speakers and incredible networking opportunities**

**Six excellent reasons why you must attend this event!**

- ★ Over 150 lighting industry experts set to attend
- ★ Over 12 hours of networking and business building opportunities
- ★ Top case studies from the most experienced lighting professionals in the world
- ★ Industry networking drinks party
- ★ Focused LED exhibition
- ★ Panel sessions, discussion groups, key note speakers

*The latest technology, developments, regulation, markets and case-studies helping you make the right decisions*

SUPPORTED BY:



**Visit [www.ledlightingsummit.com/LED](http://www.ledlightingsummit.com/LED)**

"The event attracted the right people and it was a good mixture of technology drivers and lighting professionals. I had many interesting and fruitful discussions."

**Verbatim**

# Charge Controlled LED Drivers

Jens Göhring, Head of Technical Development at diltronics explains why it is necessary to improve LED driver efficiency, precision and intelligence to keep pace with the progress of LEDs, and introduces a new driver technology to achieve these goals.

**The starting point for the development of a new technology is frequently a bewilderingly easy question. In the case of the diltronics, this reads as: Why is the development of efficient LEDs progressing constantly while driver technology stagnates?**

In the last 20 years, LED technology has taken a massive jump in its development. Meanwhile, in the areas of visualisation and illumination, the light emitting diode has made its way to replace the common light bulb or halogen lamp. In order to fully exploit the potential of LED technology, it is not sufficient to simply increase the performance of LEDs and to produce them more economically. To open up other applicative fields, it is also important to enhance the precision and intelligence of the drivers. A newly developed technology keeps up with the rapid evolution of the LED.

But, and this has become a recognition beyond LED-insiders, the obstacles for applying LEDs are as numerous as the advantages. The production distribution in colour, luminous flux and forward voltage, the shift of these parameters over current and temperature, and of course the interaction of current and temperature seem to make using LEDs a game of chance regarding their system performance (not even speaking about commercial constraints). Assistance is required to overcome, or at least minimize these complications, and LED-drivers provide this assistance with a huge variety of specific functions and features.

Basically the available drivers, no matter whether discrete or integrated, can be categorized in three groups: constant current, constant voltage and pulse width modulation (PWM). Each of these basic principles offers unique advantages and are - to some extent - easy to use in their application. With a constant current driver one might have the best control over a LED system, but it will lead to complex designs when many LED channels need to be driven individually. Constant voltage is an easy way of driving when there is only one LED-string to be lit, but less predictable when uniformity of multiple strings is demanded. Pulse width modulation became a standard in dimming LED and colour mixing, but still needs compensation for the  $V_f$ -spread of the LED which finally means a waste of energy. Considering a dynamic mode, such as change in temperature or active dimming of the LED and a multi-channel application, the control of a LED-system becomes more complex and will sooner or later hit economical boundaries. The question of electronic and optical designers will always go back to the question: How much current at what temperature does the single LED require to light up sufficiently and is it homogeneous with others? The new approach, controLED, answers this question in an astonishingly simple way: No matter at what temperature, let the LED take as much current as it wants, but take control of the time the LED has to light up.

## The Key is Charge-Control

Imagine a parallel arrangement of LEDs, where each connection is comprised of the same number of LEDs (one or more). Applying a constant voltage to this circuit would make currents flow with different power through each channel, caused by the differences in forward voltage of the LED. The controller now compares these different currents to each other, and then calculates and dedicates a specific pulse time to every single channel. A channel with LEDs with a higher forward voltage would take a lower current; the driver will apply a relatively long pulse time. Another channel, the LEDs have a lower forward voltage here, would take a higher current, so the applied pulse time will be short. In the end, each channel will most probably draw a different current compared to the others and each channel will be given a specific pulse time which equalizes the charge in all channels.

Mathematically this principle is very simple. The charge is defined as current by time (1). And we know that the electrical charge is in proportion to the luminous flux of the LED. (2)

$$Q = I \cdot t \quad (1)$$

$$Q_e \sim \pi v \quad (2)$$

For a multiple number of LED-channels this control results in identical charges per each channel and by this in a uniform appearance of all channels.

$$Q_1 = Q_2 = \dots = Q_n \quad [A \cdot s] \quad (3)$$

$$\pi_1 = \pi_2 = \dots = \pi_n \quad [lm] \quad (4)$$



**Figure 1:**  
Working principle  
of controlled  
technology

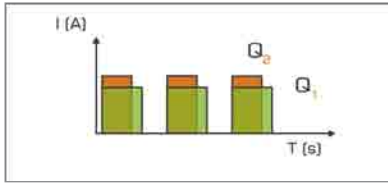

The process of this equalization is part of the technology in form of a calibration procedure when the LEDs are switched on for the first time. Within this calibration procedure, the current in each channel is measured, and the value integrated and compared to an internal reference. Then the time until the measured value is equal to the internal reference is counted. The LED-channel with the lowest current will be to a duty cycle of  $D = 0.9$ , whereby the pulse times of the other channels refer to this value. When the equivalent value is reached, the controller switches the channel off until the next sequence starts. To see this in an exemplary case makes this more comprehensive:

This might be a circuit with three high power LEDs, with a  $V_f$  of LED1: 3.45 V, LED2: 3.20 V and LED3: 3.05V at 350 mA, which are operated in a parallel circuit with a constant voltage of 3.2 V. Each LED would consume a different current, shining in different intensities, and discoloured. The controller now regulates the pulse time for the LED with the lowest current, here LED1, to approximately 90 percent of the period duration of 2.048 ms. This LED1 operates at a frequency of close to 500 Hz.

Calculating the corresponding on-time for LED2 would mean that this LED with a double current will only get an on-time half of LED1 ( $0.5 * 2.048 \text{ ms} * 0.9$ ). Additionally, to prevent flickering LEDs, the period time is cut in half and instead of one pulse the LED2 will be pulsed twice in one period time of LED1. This LED operates at approximately 1000 Hz.

In the same way, the pulse time for LED3 is determined. Compared to LED1 it has four times the current, thus it will be given only a quarter of the on-time of LED1. Again, the period time of LED3 is also only a quarter of LED1. LED3 will be pulsed four times during the on-time of LED1. LED3 operates at around 2000 Hz.

The charge through each LED is exactly the same, which results in an homogeneous appearance in colour and luminous flux.

### Unrivalled Flexibility

All the advantages of this new driving principle were made easily applicable by a LED-driver component, the DIL16CL01 ASIC.

Thanks to the precise and efficient controls, as well as clearly lowered energy consumption, this approach opens new horizons to the manufacturers of LED applications. By deploying this technology with the DIL16CL01, LED-applications become more dynamic. Users may determine to the microsecond exactly where light is needed. Where no light is necessary, energy will be cut off – this provides time for thermal relief. The control of the lighting applications in interaction

with external electronic devices, for example cameras or sensors, depends on the software implementation. Through an active feedback and communication interface (SPI), the application provides information as to which LED is active or defective at the time.

The significant reduction in power consumption contributes to the higher flexibility of your application. Thanks to the independent control of every LED, the use of Buck converters is possible: They work with an efficiency of up to 95 percent, much more efficient than the present Boost converters. The proportion of the energy consumed by the LED control sinks from 10 or 15 percent to under 2 percent. This is not just the requirement for implementing LED in mobile applications that use the majority of their energy for lighting – for example a notebook with a TFT display- but is also advantageous for off-line lighting systems. Even a portable projector, which gets its power completely from batteries, becomes reality. Altogether, this new technology significantly widens the application possibilities for high brightness LEDs: The spectrum reaches from industrial visual inspections with the highest requirements of precision up to the automotive industry, which demands product reliability under challenging environmental conditions.

### Saving Time and Money

With this technology, driver modifications can be – for the first time – completely realized through software. The vastly shortened time to market guarantees crucial competitive advantages. Through the development of new LED controls, optimization potential exists in many enterprises. Typically, an internal development department is assigned to conceive a driver for special purposes. They order the necessary hardware (for example prefabricated driver chips) and create an experimental set-up that will subsequently run an iteration of tests, which will in turn lead to a prototype of the driver electronic. This process is handicapped by the limited possibility of electronic and thermal simulation and the common deficient

**Figure 2:**  
Parallel  
arrangement of  
three LED ( LED 1:  
high  $V_f$  -  $\partial I_{f1} = 150$   
mA, LED 2: avg.  
 $V_f$  -  $\partial I_{f2} = 300$  mA  
and LED 3: low  
 $V_f$  -  $\partial I_{f3} = 600$  mA)

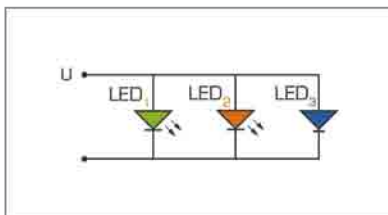

**Figure 3:**  
Controller signal  
for LED 1

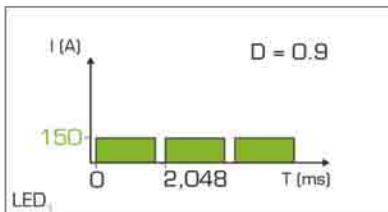

**Figure 4:**  
Controller signal  
for LED 2

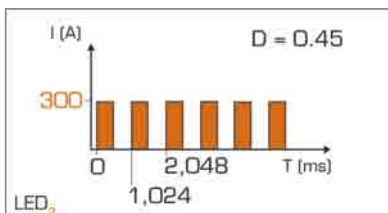

**Figure 5:**  
Controller signal  
for LED 3

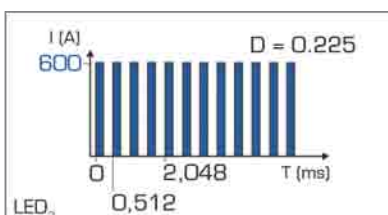



Your partner for  
high-tech competence  
in **energy efficiency**



Photo: iStock

High thermal conductivity  
Excellent for chip on board  
Optimized heat spreading  
**DBC SUBSTRATE**

Highly integrated cooler  
Outstanding thermal performance  
Customized design  
**DBC COOLER**

documentation of the hardware. Only when the driver electronics is functional, can the real development begin. In particular the thermal design of the application requires the availability of the LED as early as possible. Speeding up this process, requires the development of environments that contain all the components for the handling of high-performance LEDs in multi-channel applications. Creating applications with 80, 128 or more LED-channels became very easy.

A further fundamental advantage of this approach is the dynamic development process. Instead of developing a new driver for every application, necessary modifications are fully realized through the software. The companies can react immediately to changing requests and adapt the driver commodity to new applications. For applications that should feature more driver algorithms or are supposed to interact with sensors, free resources in the controller and memory are available – the cost and expenditure of time for the integration of external components are omitted. This concept puts users in the position to bring new products to the market quickly, flexibly and economically.

### Conclusions

Charge controlled systems are not completely new in the electronic industry. But it has never before been made applicable this easy for LED-systems. Coming from conventional driving methods, constant current, constant voltage and PWM, this technology opens the doors for applications which remained out of reach for technical or economical reasons. The tremendous reduction of complex electrical designs of multi-channel applications is an evolutionary step in LED-driver technology.

The way of working with LEDs changes in a way where users understood the control of the forward current as the key-parameter in LED driving and will now learn that current is actually less important than charge, at least in pulsed applications. Furthermore, the possibility of making LED driver hardware designs work in different applications simply by implementing application specific software is the second way that will change the way of working with LED.

controLED-technology, implemented in the DIL16CL01 pushes the boundaries further out, enabling simple designs but precise control of LEDs. It makes high-power multi-channel applications cheap, creating new ideas about what can be realized with LEDs in any part of life. ■

# 3rd **LED/OLED** Lighting Technology Expo

**LIGHTING JAPAN**

Dates : **January 19** [Wed] - **21** [Fri], 2011

Venue : Tokyo Big Sight, Japan

Organised by : Reed Exhibitions Japan Ltd.



Concurrent Shows

**NEPCON**  
JAPAN



**ELECTRONIX**  
R&D JAPAN



**AUTOMOTIVE**  
ELECTRONICS EXPO

## International Show for LED/OLED Lighting Technology

500\* exhibitors and 30,000\* visitors will gather together!

Best place to expand your business and network!

(\* expected)

For more information ▶▶ [www.lightingjapan.jp/en/](http://www.lightingjapan.jp/en/)

Organised by

 Reed Exhibitions

LIGHTING JAPAN Show Management, Reed Exhibitions Japan Ltd.  
18F Shinjuku-Nomura Bldg., 1-26-2 Nishishinjuku, Shinjuku-ku, Tokyo 163-0570, JAPAN  
TEL: +81-3-3349-8568 FAX: +81-3-3349-0598 E-mail: light@reedexpo.co.jp

# Needed Accuracy of an LED Power Supply

High quality LED drivers are mandatory for today's LED lighting applications. There is no doubt that current control accuracy is important but the output that truly matters is light. Christopher Richardson, Systems Applications Engineer for Lighting at National Semiconductors, discusses how accurate the current control has to be, and shows what would be the best solution for making the most of every cent invested in LED power supplies.

LED technology for general illumination has reached a point where high quality lamps are possible, but building a high quality LED fixture requires knowledge of power electronics, optics, and thermal management. Few engineers possess expertise in all three fields, and when the power supply engineer is also the system architect, there can be an undue focus on the accuracy of output current. There is no doubt that accuracy is important, but when the final product is a lamp, the output that truly matters is light. This article explores a focus on tight control over LED drive current which can inflate the cost of the LED power supply, when in fact it is light output that really matters. Closing the control loop on actual light output is presented as the best option for making the most of every cent invested in LED power supplies.

## Introduction

The emerging field of semiconductor lighting is creating a demand for engineers with expertise in three main fields: power electronics, optics, and thermal management (mechanical engineering). Currently there aren't too many engineers with experience in all three fields, and this often means that the system engineer or overall product engineer comes from a background in one of these fields and must do their

best to coordinate efforts from experts in the other areas. The system engineer often brings old habits from their area of expertise into the design. A similar phenomenon can occur when an electronics engineer with a focus on digital systems is faced with power management: they may rely on pure simulation and spin a PCB without lab testing their power supplies, not realizing that switching regulators require careful attention to PCB layout and cannot be trusted to behave as the simulators predict without bench testing.

In the design of an LED lamp, when the system architect is the power electronics expert or when the power supply design is contracted to an engineering firm some habits common to standard power supply design can creep into the LED drive. Some such habits are beneficial, and in many respects an LED driver is quite similar to a conventional, constant-voltage power supply. Both types of circuits operate from a wide range of input voltages and over wide ranges of output power. Both types of circuits face challenges depending upon their connection to AC mains, to regulated DC rails or to batteries. One habit of power electronics engineers that isn't always so helpful for LED drives is the desire for high accuracy of the output – voltage or current. Digital loads like FPGAs and DSPs require ever lower core voltages which in turn require

ever tighter control to prevent high rates of bit error. As a result, tolerances for digital power supply rails are commonly controlled to within  $\pm 1\%$  or less of their nominal value, or are specified in absolute terms, i.e. 0.99V to 1.01V. The problem with applying this habit from traditional power supplies to the field of LED drivers is that tight tolerances of output current require more power to be wasted, more expensive components, or both.

## Making Every Penny Count

The ideal power supply costs nothing, has 100% efficiency, and occupies no space at all. Power electronics engineers are used to hearing this from their customers, and they make the best of these demands by designing the system with the best efficiency in the smallest space while using the budget they are given. LED drivers are no exception, and in fact, are pressed particularly hard in terms of budget because conventional lighting technology is fully commoditized and very affordable. Therefore, it is extremely important to make the best use of every penny allotted. This is where some power electronics designers are led astray by those old habits. Controlling an LED current to the same accuracy as the supply voltage of a digital load wastes power and money. Assuming that the currents in question range from 0.1 A to 1A covers the majority of designs being released today, especially



**Figure 1 (left):**  
Voltage feedback  
(a) and current  
feedback (b)

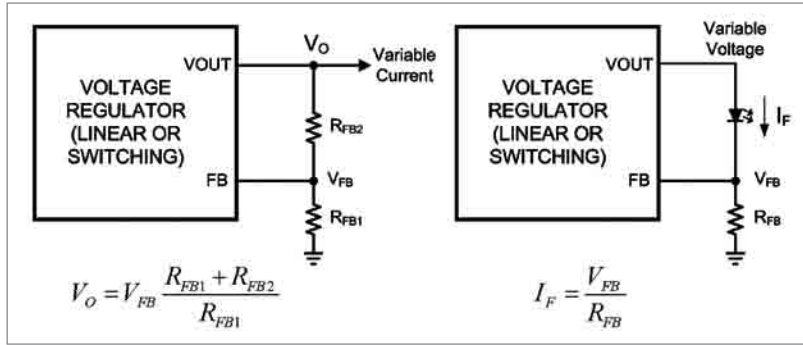

**Figure 2 (right):**  
Optical integrating  
sphere in cross-  
section

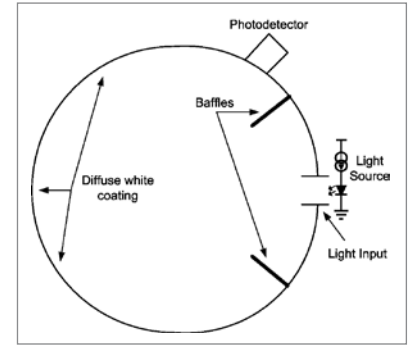

**Table 1:**  
Luminous flux  
bins for cool white  
LEDs tested at 350  
mA and at 25°C

Manufacturer	Luminous Flux Range of Lowest Bin (lumens)	Tolerance of Lowest Bin (%±)	Luminous Flux Range of Highest Bin (lumens)	Tolerance of Highest Bin (%±)	Averaged Tolerance of All Bins (%±)
A	114 to 122	3.39	139 to 148	3.14	3.26
B	40 to 50	11.11	100 to 120	9.09	10.10
C	89.2 to 97	4.19	112 to 121	3.86	4.03

considering that 350 mA (or, more precisely, a current density of 350 mA per square millimeter of opto-semiconductor junction) has become a common compromise between thermal management and luminous efficacy. The ICs that control LED drivers are silicon based and therefore have a typical band gap in the range of 1.25V. To achieve a tolerance of 1% at 1.25V requires a range of  $\pm 12.5$  mV. This is not difficult to achieve, and affordable voltage references or power supply control ICs that boast such a tolerance or better are both plentiful and affordable. When controlling output voltage, high precision resistors can be used to feed back the output voltage while dissipating very little power (Figure 1a). To control output current requires a change in feedback method as shown in Figure 1b. This is by no means the only way to control output current, but it is the simplest.

Upon further inspection a principal disadvantage becomes evident: the load and the feedback circuit are one and the same. The reference voltage is applied across a resistor in series with the LEDs, and this means that the higher the reference voltage or the LED current the greater the power dissipated in that resistor. As a result, the first generation of dedicated LED drive ICs had much lower voltage references, similar to those found in battery chargers. Lower voltage meant

less power dissipation, which also meant smaller, cheaper, lower power current sense resistors. In a simple case with low-side feedback -- as shown in Figure 1b -- 200 mV was a common choice. Expecting a tolerance of  $\pm 1\%$  from a 200 mV reference, however, is an invitation for an overpriced IC. This translates to a tolerance of just 2 mV above and 2 mV below the nominal reference voltage. While not impossible, the higher precision does not come for free. A  $\pm 2$  mV tolerance would likely require production, testing and binning techniques reserved for high precision voltage references. The added cost would be much better spent on more intelligent LED drivers. One particular feature that is worth the added cost is an additional feedback loop that allows light output, not current output, to determine how the LEDs are driven.

### Measuring Light Output

Just as the digital designer looks to simulation when faced with the uncertain territory of power supply design, so the power electronics engineer turned-System Architect may go for the familiarity of high accuracy outputs when faced with an LED lamp design. LED manufacturers have made it clear that luminous flux is proportional to forward current. Drive all the LEDs with the same current, and each one should produce the same flux. The power electronics

engineer then reasons that a highly accurate current is needed. In doing so, they forget that lumens and lux, not amperes, are the outputs that truly matter. Amperes are easy to measure. Light, on the other hand, requires expensive, bulky equipment such as the integrating sphere (Figure 2) which is not a familiar instrument to most electronics engineers.

What's more, even a current source with a tolerance of  $\pm 0.1\%$ , (which would be quite expensive) would have plenty of marketing value but little use in producing tight tolerance of actual light output. This can be confirmed by observing the binning of luminous flux for the LEDs. Table 1 shows the luminous flux bins for cool white LEDs tested at 350 mA and at 25°C for top-grade LEDs from the top three of the world's power opto-semiconductor manufacturers. Note that the final column is the average of the tolerances of the individual bins, not the tolerance across all the luminous flux bins.

### Calculating Light Output Accuracy

Knowing that the LED's light output from a single flux bin has a tolerance ranging from  $\pm 3\%$  to  $\pm 10\%$  might lead the system engineer to conclude that drive current tolerance must indeed be as tight as possible, but from a statistical viewpoint this is not correct. A common but incorrect assumption

**Table 2:**  
Overall tolerances vs. a list of hypothetical current source tolerances

Current Source Tolerance (%±)	Overall Tolerance with A (%±)	Overall Tolerance with B (%±)	Overall Tolerance with C (%±)
0.1	3.26	10.10	4.03
0.2	3.26	10.10	4.03
0.5	3.27	10.10	4.04
1	3.30	10.11	4.06
2	3.41	10.15	4.15
5	4.11	10.40	4.74
10	5.97	11.27	6.42

**Figure 3:**  
Overall light output tolerances vs. current source tolerances

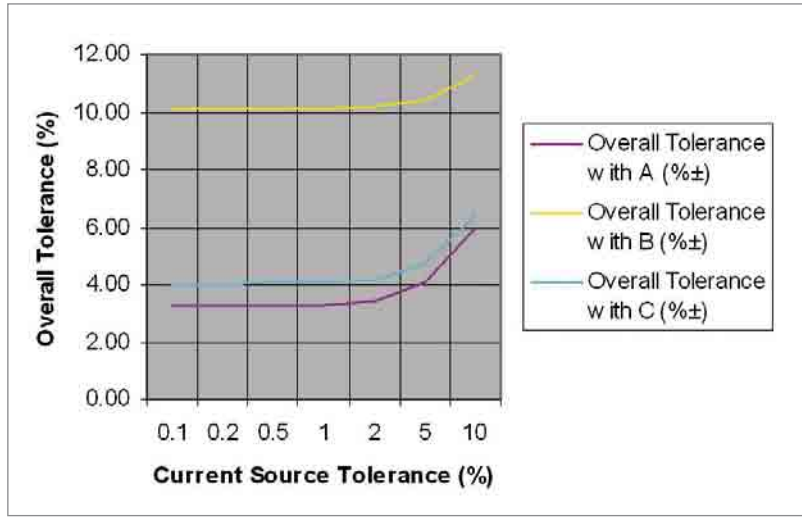

**Table 3:**  
Tolerance of the LED's light output

Manufacturer	Flux Range of Top Two Bins (lm)	Flux Tolerance of Top Two Bins (%±)	Flux Range of Top Three Bins (lm)	Flux Tolerance of Top Three Bins (%±)	Flux Range of Top Four Bins (lm)	Flux Tolerance of Top Four Bins (%±)
A	130 to 148	6.5	122 to 148	9.6	114 to 148	13
B	90 to 120	14	80 to 120	20	70 to 120	26
C	104 to 121	7.6	97 to 121	11	89 to 121	15

for overall tolerance of any value of interest is that the worst-case values simply sum. The tolerance of the current source powering the LEDs and the tolerance of the flux from the LEDs are uncorrelated – they vary independently of one another on a first order basis. For uncorrelated two factors X and Y, the overall tolerance, Z, is not the sum of the tolerances of X and Y. It can be calculated with the following expression:

$$\frac{\Delta Z}{Z} = \sqrt{\left(\frac{\Delta X}{X}\right)^2 + \left(\frac{\Delta Y}{Y}\right)^2} \quad (1)$$

When Equation 1 is evaluated it shows that the factor with the worst tolerance dominates the others, and also that the true overall tolerance is significantly better than the sum of the worst cases of the individual factors, especially when one factor is much greater than the others. Observing the graph in Figure 3, a more reasonable target for current source tolerance would be in the range of the tolerance of the LED's light output. Keeping in mind that for cost purposes many lamps use LEDs from several bins, the tolerances for the top two, top three, and top four luminous flux bins for the same LEDs as those of Table 1 have been listed in Table 3 for reference.

### Quality LED Lamps have more Feedback

LED manufacturers and their distribution partners are working hard to improve the tolerance of luminous flux for their products and to provide narrower bins at reasonable cost. For designers who want to build a high quality product capable of lasting five years or for 50,000 hours and maintain the total light output over that time, even the tightest flux binning and the mythical 0.1% tolerance current source simply will not suffice. This is because two important factors reduce the flux from LEDs that cannot be accounted for even if the current source tolerance and LED flux tolerances were each 0.001%: heat and time-based degradation. To account for these loss terms designers of quality solid-state lighting products must look to power supplies with additional feedback loops, namely heat and light itself. For these purposes dimming control is needed, and control ICs with the ability to adjust output current both linearly and with PWM are the best equipped.

### Two Driver Examples for Everything else

The LM3409 and LM3424 are LED driver control ICs which represent the second generation of current sources for semiconductor lighting. Both offer control over average LED current via variable resistors or voltage sources, and both offer dedicated inputs for PWM dimming signals. In addition to enabling linear control loops, the analog adjust functions of the LM3409 and LM3424 also allow the system designer to make their own decision when trading off output current accuracy for size, cost, and power dissipation in the current sense resistors.

The LM3409/09HV, shown in Figure 4, controls buck circuits, the most common type used in power LED drivers. The LM3424 is shown in Figure 5 as a boost regulator LED driver but is also capable of buck-boost, SEPIC, flyback and even 'floating' buck circuits.





# Imprint

LED professional Review (LpR)  
ISSN 1993-890X

## Publisher

Luger Research e.U.  
Institute for Innovation & Technology  
dep. LED professional  
Faerbergasse 15, Haus Rot  
A 6850 Dornbirn, Austria / Europe

phone +43 5572 394 489  
fax +43 5572 394 489 90  
editors@led-professional.com  
www.led-professional.com

## Publishing Editors

Siegfried Luger  
Arno Grabher-Meyer

phone +43 5572 394 489  
phone +43 5572 394 489-18  
editors@led-professional.com

## Int. Account Manager

Theresa Koenig  
phone +43 5572 394 489-20  
theresa.koenig@led-professional.com

## Front-page picture

Image: Arno Grabher-Meyer, LED professional, eldoLED Powerdriver  
Artwork: Thomas Klobassa, ©LED professional 2011

## Copyrights – Luger Research e.U.

The editors make every reasonable effort to verify the information published, but Luger Research e.U. assumes no responsibility for the validity of any manufacturers, non profit organisations or individuals claims or statements. Luger Research e.U. does not assume and hereby disclaims any liability to any person for any loss or damage caused by errors or omissions in the material contained herein, regardless of whether such errors result from negligence, accident or any other cause whatsoever. You may not copy, reproduce, republish, download, post, broadcast, transmit, make available to the public, or otherwise use LED professional Review (LpR) content without prior written consent from Luger Research e.U. – Institute for Innovation & Technology, Austria. ■



## LED professional Review (LpR) - Annual Subscriptions

### LpR Digital Magazine

- 6 issues
- pdf download
- high resolution pictures and graphs
- printable
- commercial use
- access to all previous issues
- Euro 78.80

<http://www.led-professional.com/subscription>

### LpR Printed Magazine

- 6 issues
- Euro 158.40

Next LpR Issue - March/April 2011  
LED Testing, Simulation & Manufacturing

# LED professional



## LED Lighting Technologies

27-29 September 2011 | Festspielhaus Bregenz | AUSTRIA

FOR DETAILED INFORMATION ON SPONSORSHIP & EXHIBITION OPPORTUNITIES PLEASE CONTACT US:  
Ms. Theresa Koenig | +43 5572 394489 20 | [theresa.koenig@led-professional.com](mailto:theresa.koenig@led-professional.com)

[WWW.LED-PROFESSIONAL-SYMPOSIUM.COM](http://WWW.LED-PROFESSIONAL-SYMPOSIUM.COM) | [SYMPOSIUM@LED-PROFESSIONAL.COM](mailto:SYMPOSIUM@LED-PROFESSIONAL.COM)

Light Source—LED/OLED—Energy Saving  
**Green Lighting**  
Lighting Products—Lighting Systems/PV Solar Cells—Lighting Applications—Thermal Solutions

**Shanghai Expo and Forum 2011**

**Accelerate Your Business with  
China's One-stop LED B2B Platform**  
— Expand Your Market Share — Enhance Your Company's Brand  
— Extend Your Business Network

**May 11~13, 2011 — Intex Shanghai**



ORGANISED BY



[www.greenlightingchina.com](http://www.greenlightingchina.com)

**For the Exhibition** Miss Selina Wang, Tel: +86 21 5153 5110, [selina.wang@reedexpo.com.cn](mailto:selina.wang@reedexpo.com.cn) **For the Forum** Miss Betty Xu, Tel: +86 10 5172 7115 [xuny@china-led.net](mailto:xuny@china-led.net) **For Media** Miss Sonia Xia Tel: +86 21 5153 5178, [sonia.xia@reedexpo.com.cn](mailto:sonia.xia@reedexpo.com.cn)

# TRIDONIC

▼ enlightening your ideas



What we do for your light.

## Lasting partnerships to help you master every step of your project.

Light is not always the same. You define what your light should look like. Together we will take your ideas and turn them into successes. The foundation for this is: convincing product solutions and personal commitment. We accompany and support you and your projects. We devote all our energy to your light.

**[www.tridonic.com](http://www.tridonic.com) – Visit us at Euroshop from February 26 to March 2, 2011, Hall 11, Booth A15.**