

LED

professional

BY LUGER RESEARCH

Review

LpR 101

Jan/Feb 2024

EXPLORING CROSS-DISCIPLINARY LIGHTING INNOVATIONS & LPS DIGITAL AWARDS

OPTICAL DESIGN
WITH JENNIFER ASPELL

SOLID-STATE LIGHTING
REPORT

light+building

MUST SEE
INNOVATIONS

The Global Information Hub
for Lighting Technologies
and Design

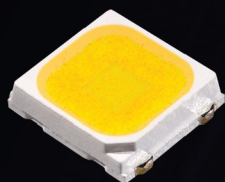

Cree LED J Series® JB3030C White LEDs

Industry-leading efficiency,
two performance options

Cree LED J Series® JB3030C E & F Class White LEDs excel in diverse applications. Select from industry-leading LED efficiency, offering up to 242 LPW for outdoor areas and indoor harsh environments, or an impressive 3.33 PPF/W typical for horticulture. Sharing the same high-reliability package, both options enable luminaire manufacturers to boost performance with unmatched durability.

- Top-tier mid-power LED efficacy: up to 242 LPW typical or 3.33 PPF/W typical
- Easy to design in: 301B compatible footprint
- High reliability: excellent sulfur resistance, LM-80 available now
- Available in 6500K-2700K, 70-90 CRI

Get the details: cree-led.com/news/jseries-JB3030C/

Always Innovating. Always Leading.

Follow us at:



WÜRTH ELEKTRONIK MORE THAN YOU EXPECT

PERFORMANCE.
RELIABILITY.
SERVICE.

Optocouplers by Würth Elektronik

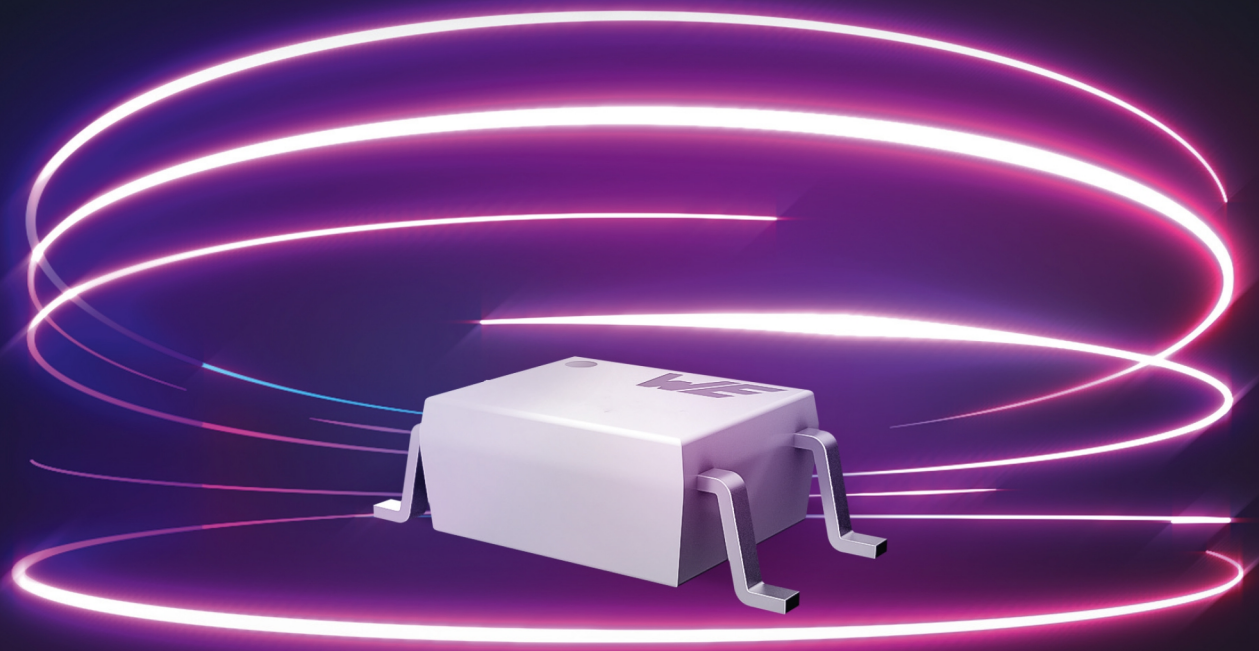

© eiPal



WE are here for you!

Join our free webinars on:
www.we-online.com/webinars

Optocouplers by Würth Elektronik

With the new optocouplers, Würth Elektronik presents one of the latest additions to its optoelectronic product portfolio. The innovative design features a coplanar structure and high-grade silicon for total internal reflection. The coplanar design ensures the isolation gap stay fixed during the production process and provide perfect isolation and protection for your application. The total internal reflection provide stable CTR over the whole temperature range and high CTR even at low current operation.

Provided in all industry standard packages. Available with all binnings ex stock. Samples free of charge: www.we-online.com/optocoupler

Highlights

- Innovative coplanar design
- High grade silicon encapsulation
- Copper leadframe for high reliability
- Stable CTR over whole temperature range
- High CTR in low current operation



DIP-4



SOP-4



LSOP-4

#OptocouplersbyWE

Exploring the New Era of Lighting Excellence



As we step into the New Year, we would like to extend our wishes for a prosperous, healthy, and peaceful year to all our readers. On our side, we are excited to be able to present several highlights to you.

The recent LpS Digital Summit, themed "Cross-Disciplinary Lighting Innovations," provided us with boundless inspiration, the details of which we are delighted to recapitulate for you. In addition, we will introduce you to the recipients of the LpS Digital Awards.

The imminent Light + Building event is another focal point, featuring a compilation of "Must See Innovations" and details about this much-anticipated event in Frankfurt this coming March.

This edition also includes several expert articles. Dr. J. Norman Bardsley provides the latest trend insights in his Solid-State Lighting Report. Katharina Keller from Zumtobel introduces a breakthrough technology for downlighting diffusers, and Kumux explores the realm of cloud-based lighting solutions.

We also investigate the practical benefits of sustainability. A Zumtobel project delves into this, offering impressive results and insights into what the Circular Economy can truly entail. Additionally, we present a new trend in light measurement technology.

This first issue of 2024 features two exceptional lighting experts: Lawrence Lin ponders the future of lighting in his insightful commentary and Jennifer Aspell, takes us into the world of optical innovations.

We wish you, dear readers, enjoyable reading of this installment with its trendy outlook and vision. We also look forward to, perhaps, meeting up with you in Frankfurt!

Yours Sincerely,

Siegfried Luger

Luger Research e.U., Founder & CEO
LED professional, Trends in Lighting, LpS Digital & Global Lighting Directory
International Solid-State Lighting Alliance (ISA), Member of the Board of Advisors
Member of the Good Light Group and the European Photonics Industry Consortium

LED Solutions for all your Industrial Applications

LEDs

- High Brightness Surface Mount Lamps
- RGB & Monocolor PLCC LEDs
- ChipLEDs Monocolor, Bicolor & Tricolor
- Automotive 1608, 2835 & PLCC
- Infrared LEDs and Photodiodes
- UV-A High Power LEDs
- High Power white and colored
- High Brightness Through Hole Lamps

LED Displays

- Smart Alphanumeric Displays
- Surface Mount & Through-hole 7 Segment Displays (customizable)
- Light Bars

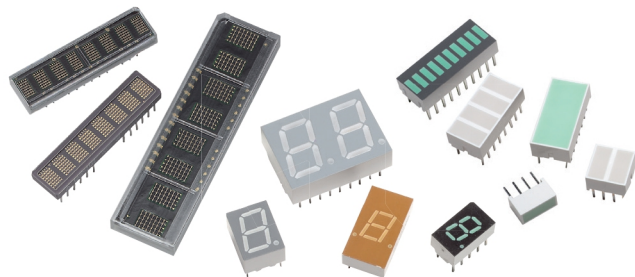

Choose Broadcom for high performance, efficiency & reliability

Broadcom Inc.

www.broadcom.com/leds

About Broadcom Broadcom Inc. (NASDAQ: AVGO), a Delaware corporation headquartered in San Jose, CA, is a global technology leader that designs, develops and supplies a broad range of semiconductor and infrastructure software solutions. Broadcom's category-leading product portfolio serves critical markets including data center, networking, enterprise software, broadband, wireless, storage and industrial. Our solutions include data center networking and storage, enterprise, mainframe and cybersecurity software focused on automation, monitoring and security, smartphone components, telecoms and factory automation.

Broadcom LEDs Known for its LEDs' performance, efficiency and reliability, Broadcom offers an extensive portfolio of products that include high brightness and high power LEDs, PLCC surface-mount LEDs, and display backlighting module solutions. These LEDs and display modules address a wide range

of markets, including electronic signs and signals, automotive, solid state lighting and LCD display backlighting. LED Display customers can rely on products that deliver high reliability, long life expectancy, and are resistant to extreme weather conditions, mechanical vibration, and shock. With our innovative LED Displays, customers can choose products with rich color capabilities, low cost, standard brightness and high ambient light that are designed to meet a variety of industrial and consumer applications.

Why Broadcom LEDs

- Extensive range of LED solutions
- High performance and efficiency
- Long life expectancy and high reliability
- Very robust in extreme weather conditions

New in our Portfolio

IR LEDs

Our latest IR LEDs come in various package platforms and footprints within the 820 nm to 940 nm wavelength range, appropriate for light curtains, smoke detectors, metering, remote control handsets, security

systems, video cameras, automated card reader systems and industrial sensors.

UV-A LEDs

We have a wide range of UV-A LEDs and near UV LEDs, typically in the wavelength range of 365nm to 425nm. End applications are industrial ink curing, horticulture lighting, water/air purification, disinfection, medical phototherapy and banknote counterfeiting.

Hot Product SMT Lamp

Broadcom's unique SMT-Lamp package combines a narrow viewing angle with SMD technology

This product family is an ideal solution for outdoor applications. The robust package has an integrated round or oval lens made from Epoxy, is available in different viewing angles and in all colors.

Contact one of our authorized distributors:

www.broadcom.com/how-to-buy

4 EDITORIAL

COMMENTARY

8 **The Future of Lighting**
by Lawrence LIN, Founder of Lighting Recipe Studio



NEWS

10 **Light + Building 2024 – News**



light+building

LIGHTING INTERVIEW

24 **Jennifer Aspell, CEO of BrightView Technologies**
compiled by Editors, LED professional



LpS DIGITAL SUMMIT

30 **LpS DIGITAL Summit and Awards: Exploring Cross-Disciplinary Lighting Innovations**
by Editors, LED professional



REPORT

40 **Solid-State Lighting Report**
by Dr. J. Norman BARDSLEY, Founder and SSL Analyst, Bardsley Consulting

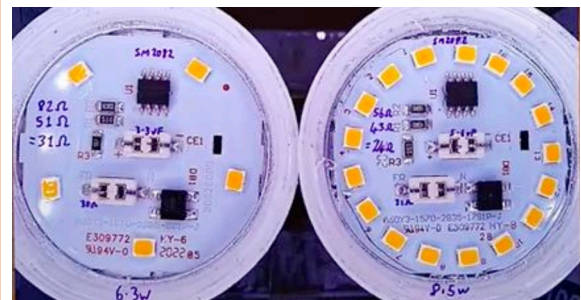

OPTICS

42 **Redefining Glow: A Breakthrough Diffuser for Downlighting Excellence**
by Katharina KELLER, Director of Optics at Zumtobel Lighting

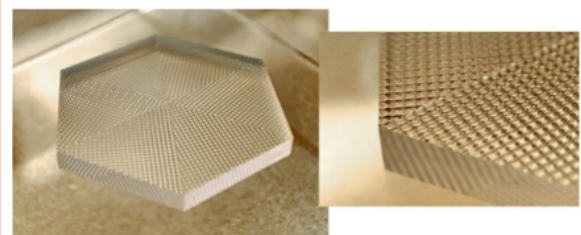

CONTROLS

44 **KUMUX. An Innovative Software Approach for Dynamic Lighting**
by KUMUX



ECODESIGN

48 **Illuminating Sustainability: Zumtobel's Pioneering Circular Economy Venture**
by Zumtobel Lighting

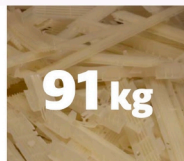

MEASUREMENT

52 **Measurement of the Luminous Flux More Accurate**
by Florian HOCKEL, Segment Leader LITE, Lamps and Multimedia Products at TÜV SÜD

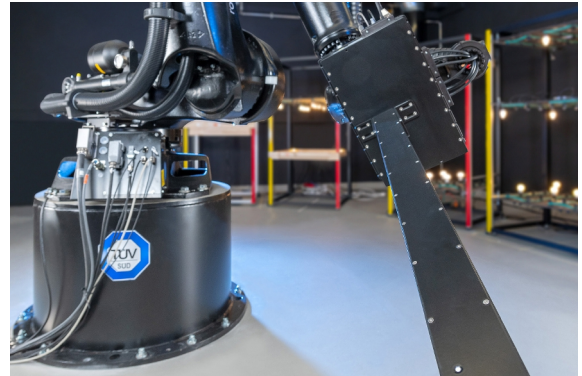

LPS DIGITAL TALKS

54 **Expert Talks on Light – Micro-Optics in Automotive Lighting**



58 **ABOUT | IMPRINT**



ADVERTISING INDEX

2 Cree LED	15 Yujil leds	56 LCA Calculator
3 Würth	17 UL	57 Good Light Group
5 Broadcom	18 Instrument Systems	59 Global Lighting Directory
9 PHABULOuS Pilot Line	19 Röhm	60 LED professional Review
11 ERCO	21 LightingEurope	
12 Cree LED	29 Trends in Lighting	
13 Edison Opto	47 LED professional Review	



Lawrence LIN

Lawrence LIN is a distinguished figure in the LED and lighting industry, boasting 25 years of remarkable experience. He is celebrated for his profound expertise and extraordinary contributions to the field. As the Founder of Lighting Recipe Studio Co., Ltd, Lawrence remains at the forefront of innovation, continually shaping the industry's future. (In addition to his role as CEO of Lawrence Co., Ltd, Lawrence also serves as the company's Head of Consulting.)

His focus lies in steering industry turnarounds, facilitating transformations, and driving development initiatives. Previously, Lawrence held the prestigious position of CEO of LEDVANCE GmbH, a major player in the global lighting sector. His strategic prowess and visionary leadership were instrumental in the successful acquisition of LEDVANCE GmbH, formerly SYLVANIA general lighting in the USC, and OSRAM general lighting globally. Throughout his illustrious career, Lawrence has demonstrated a deep understanding of LED packaging, lamp and luminaire production, supply chain management, innovation strategy, cross-border mergers and acquisitions, corporate management, turnaround expertise, and transformation know-how. His vast network spans influential figures in China and across the globe. Lawrence Lin's linguistic talents encompass English, Chinese, and Taiwanese, enriching his global impact on the industry.

The Future of Lighting

Will the lighting sector maintain its brilliance in the years ahead?

Artificial electric light sources have been popular for more than 140 years since they were officially introduced in the 1870s, and have gone through thermal radiation, fluorescent lamps, gas discharge to semiconductor. Not only the performance span of the luminous efficiency from 15lm/W to 150lm/W has improved 10fold, the ability of miniaturized semiconductor light source and digital dimming for spectrum & brightness mixing has further boosted the possibility of lamp form and light. Booming research of optical biological science such as IpRGCs and Circadian rhythms, AloT technology and the development of ecosystems in recent years, has enabled lighting to open up huge opportunities that have not been seen in the past 140 years, and is very likely to create a brand new growth ground.

“Today’s artificially illuminated environment is almost harmful to one’s health!”

LAWRENCE LIN

Today’s indoor illuminated environment is almost harmful to one’s health! The daytime is not bright enough, the nighttime is not dark enough, the horizontal illumination is overemphasized but the vertical illumination is ignored, and the spectrum is missing. Now, because of a deeper understanding of the visual and non-visual effects of light, coupled with the semiconductor light source and AloT technology, it has further improved the solution capabilities of the light environment. Over the past 140 years the electric light source has ranged from one house, one room and one lamp to multi-level lamps, some even combined with intelligent control systems. They have gone from only meeting the needs of visual safety and operation to the pursuit of new needs such as visual comfort, light and shadow effects, and visual art, circadian rhythm phase setting, emotional feedback, etc. We

are now forced to re-examine the question of whether existing building regulations, lighting standards, scene protocols and software firmware standards can be healthy. At the same time, we need to promote the development of the industry and provide users with more convenient and cost-effective, high-quality and healthy solutions.

“We need an ecosystem with devices, algorithms and APPs to enable light-as-a-service and fully automatic smart lighting systems.”

LAWRENCE LIN

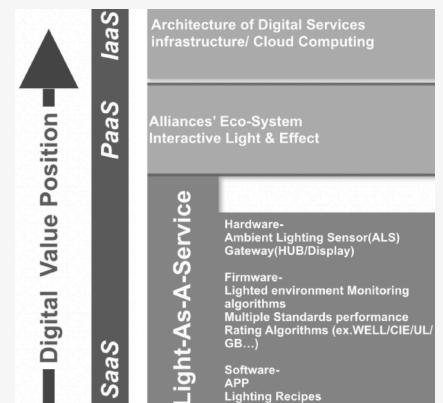

Is lighting still an industry with a bright future?

Of course! However, the industry urgently needs to build a consensus. The implementation of this process depends on the industry associations, leading enterprises and government authorities sharing a mutual vision to make the disciplined development of the whole industrial chain so as to drive the transformation and upgrading of the industry with intelligence and health, face a bright future, and promote high quality human enjoyment and a healthy lighted environment. The efficiency gains of LEDs were achieved through a shared vision. The same is now required for our own well-being with artificial lighting. ■

L.L.

MICRO-OPTICS IS...

Phabulous

Discover the benefits of Free-form micro-optics:

- Enhance efficiency of light coupling
- Improve color mixing
- Customize the direction of the light
- Achieve global lighting uniformity
- Compactness optimization

Start a **FEASIBILITY STUDY** with the **PHABULOuS Pilot Line**. Funding available for European companies.

www.phabulous.eu

Funded by



PHOTONICS PUBLIC PRIVATE PARTNERSHIP

PHOTONICS²¹

PHABULO μ S is an EC funded initiative, in a public-private partnership with Photonics21. www.photonics21.org. PHABULO μ S has received funding from the European Union's Horizon 2020 research and innovation programme under grant agreement n° 871710.

© 2022 European Commission and Photonics21. All rights reserved

light+building

MUST SEE INNOVATIONS & ORGANIZATIONS

ERCO

<https://www.erco.com/en/> | Hall 5.1, B20

If a brand with decades of experience in museum lighting develops a new system for showcases, lighting designers and users are justified in expecting a lot. With *Axis*, ERCO now presents a modular lighting system that sets the benchmark for quality of light in showcases: protective, effective, flexible and precise. And of course with digital connectivity. The system includes miniaturized stem luminaires, surface-mounted luminaires and semi-recessed luminaires that can be individually adapted to their tasks.

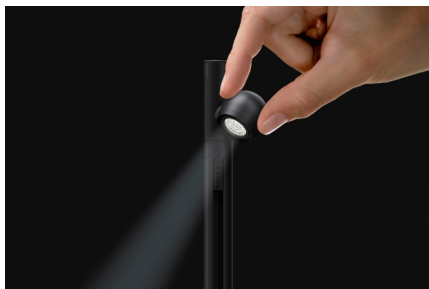

Axis from ERCO. A new lighting system for showcases.

ERCO lighting tools are already in use in thousands of galleries and museums around the world to optimally display architecture and exhibits. For many curators, exhibition organizers and conservators, the quality of light and design quality of ERCO spotlights for track sets the standard. The new *Axis* system provides just such qualities on a miniaturized scale. *Axis* completes the existing ERCO product range for museums, thus allowing the highly consistent implementation of holistic lighting concepts for multi-storey atriums with large sculptures, halls and galleries of any format and small-scale cabinets – and now also in showcases, displays and dioramas.

With extremely variable positioning

When illuminating exhibits in showcases it's all about creating magic on a small stage – whilst optimally protecting sensitive materials and s. LED lighting with *Axis* therefore fulfils high conservation requirements: free of UV components, with qualitative color rendering (up to CRI>97) and with a very low damage factor of 0.140 - 0.187mW/lm. Based on this certitude, exhibition organizers can devote themselves entirely to the perfect display of their exhibits.

Axis functions with spherical pan-and-tilt LED light heads with a diameter of just 25 mm. The

system offers various options for positioning these light heads: the single, twin and 4-gang semi-recessed luminaires integrate elegantly into showcase bases and ceiling panels. As a modular surface-mounted luminaire, one or more light heads on a cylindrical base project into the showcase. The variable stem luminaire provides additional flexibility in terms of the height of the light points. The stable mechanical and electrical connection of up to three light heads (two light heads with ceiling mounting) is established without tools using magnetic holders. In combination with the three interchangeable lens optics – spot (approx. 17°), flood (approx. 32°) and wide flood (approx. 45°) – exhibits can be illuminated in nuanced ways from all desired directions. *Axis* uses the same lens technology as the 'large' ERCO spotlights to achieve optimum efficiency and quality of light. This means: precise, brilliant, highly uniform beams of light with no spill light.

Adaptable – thanks to individual accessories

After the positions of the light heads in the showcase and their beam angles have been determined it is a matter of lighting up: *Axis* semi-recessed luminaires feature 360° rotation and 140° swiveling. The magnetic *Axis* modules of the stem and surface-mounted luminaire can be freely rotated around their cylindrical axis and the light heads can be swiveled through 270°. An *Axis* control gear unit can supply up to 12 light heads, and such a group can be dimmed directly on the control gear using a potentiometer, wirelessly via Casambi Bluetooth or via a gateway with DALI – as low as 1% luminous flux. The luminous flux of individual light heads can also be individually reduced using clip-on, accessory neutral density filters. Various lens units, blue light filters for additional protection of sensitive exhibits, soft focus and sculpture lenses as well as anti-glare attachments such as snoots or honeycomb anti-dazzle screens are also available as accessories, making *Axis* extremely customizable.

Independently tested and certified

The specific strengths of *Axis* are especially evident in combination with other ERCO lighting tools such as 48V spotlights and wallwashers. *Axis* luminaires provide precise accent lighting from a short distance, with e.g. Eclipse 48V spotlights being used at larger distances or for higher illuminances. In larger showcases, 48V wallwashers are able to uniformly illuminate the rear walls whilst *Axis* effectively display the individual exhibits.

The selection of LED light colors for *Axis* corresponds to the ERCO standard: 2700 to 4000K with CRI 92 and 3000K with CRI 97 are available. As with the spotlights, the LEDs assembled in *Axis* also have an especially high color matching of 1.5 SDCM, meaning that even trained eyes will not be able to detect a difference in the color location – the appearance is completely uniform. *Axis* is also

currently the only ENEC and UL certified showcase lighting on the market, thus offering a high and independently tested safety standard. This is an important argument for all professionals in museums who will be working with *Axis* showcase lighting in the future and entrusting their irreplaceable collection objects to its light.

Discover *Axis* showcase spotlights – For big magic on a small stage: [Axis Video](#). ■

ERCO

<https://www.erco.com/en/> | Hall 5.1, B20

Three lighting principles have characterized lighting design since the 1950s: ambient luminescence, focal glow and play of brilliants – the basis of ERCO's lighting philosophy from the very beginning. For its trade fair presence at Light + Building 2024, ERCO is now adding a twist to Richard Kelly's "grammar of light": Instead of the play of brilliants, trade fair visitors will enjoy "hands-on light". ERCOplay, an exclusive corridor on a second level of the ERCO trade fair booth, harbors exciting, interactive lighting tasks. Enthusiasts of light have the opportunity to actively engage and experiment with lighting and luminaires on various scales, ranging from the very small to the impressively large.

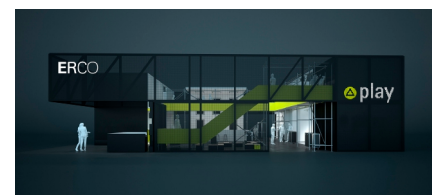

ERCOplay: Prove your lighting expertise at six stations.

ERCOplay – interacting playfully with light and products. For visitors to Frankfurt, the motto is therefore 'hands-on light'. Everyone is invited to give free rein to their skills, curiosity and love of experimentation. Six stations with various lighting tasks awaken the play instinct of every light enthusiast. As the number of participants is limited, registrations for time slots are available here: www.erco.com/lb24

ERCOplay: Prove your lighting expertise at six stations

ERCO showcases its solutions at a trade fair booth which, deviating from the traditional

Axis showcase lighting

For big magic on a small stage



ERCO quality of light
The benchmark for best light quality in the showcase



Precisely illuminating
From above and from below - recessed or on a stem



Simple, flexible
Magnetic light heads, interchangeable lenses and filters

Light is the fourth dimension of architecture

www.ercocom/axis-site

concept of solely displaying products, is actually something quite different: It is more like a playing field that, in accordance with Kelly's three principles, also offers hands-on light in addition to ambient luminescence and play of brilliants. Play instinct is highly welcome. ERCOplay is an interactive corridor on a second level above the application areas and the bar. The motto here is 'hands-on light': A game revolving around light where visitors pass through six stations in 15 minutes and are faced with different lighting tasks, ranging from the illumination of small objects with the new Axis showcase lighting to the precise alignment of spotlights and floodlights all the way to the "Downlight Bingo" challenge. The best players will be awarded prizes.

Showcase lighting, light structures etc.: New product solutions in action

Visitors can expect to discover the latest product solutions from the light factory not only at the ERCOplay playing stations, but throughout the entire booth area. The Lüdenscheid-based company has significantly expanded its portfolio in the application area of exhibition lighting. For big magic on a small stage, ERCO is now also offering Axis showcase lighting. A modular lighting system that sets the benchmark for lighting quality in showcases and comprises miniaturized and digitally controllable stem luminaires, surface-mounted luminaires and semi-recessed luminaires. Ranging from short light rods to elongated light structures, the lighting solutions extend to include Invia48V –

a modular continuous-row light structure for museums and galleries, public buildings and offices that is more than just a design element: It can be used for a wide range of lighting tasks, all the way from simple ambient lighting to dramatic accent lighting. Wallwashing is the highlight, characterized by outstanding uniformity even across room corners. Other product highlights available to see and touch include Quinta recessed spotlights with Darklight lenses for unbeatably precise light control and even better visual comfort. Also included is the new edition of the top-selling Optecspotlight, which combines proven high quality of light with unbeatable efficiency (as measured in lx/W) and a particularly long service life. And just as the luminaires are designed for maximum durability, the trade fair presentation at Light + Building 2024 has also been designed to be sustainable.

Durability: Part of the luminaire DNA, basis of the trade fair concept

For ERCO, sustainability is not only linked to climate-neutral production – it is also reflected in the service life of its products. With "Lighting Durability: 20 Years of service life", they have formulated the development goal of designing particularly durable, economical and sustainable lighting solutions. This approach is continued in the trade fair presentation. The concept of the exhibition booth is also based on the sustainable use of materials. An exhibition booth in the classic sense is a space customized for product presentation for one-off use. In times of resource scarcity,

climate change and rightfully demanded "green rethinking", ERCO has consistently designed and conceived this year's appearance at Light + Building with sustainability in mind. Components or materials that are not absolutely necessary are omitted, and elements already available on site are sensibly integrated into the booth architecture. Starting with the booth floor: Instead of using a floor built exclusively for the trade fair week, the hall floor was integrated into the booth concept.

The decision was made to use materials and objects that have been in use for a long time and that will continue to be used or be recycled after the trade fair. This includes road cases, which have been used at ERCO for years for local trade fairs and have already seen events all over the world. They will be used as presentation tables, newly equipped with innovations, and will return to the road after Light + Building. In addition, the frame structure of the 2018 Light + Building booth will be re-used and the corridor for ERCOplay is a rental scaffold that will continue to be used after the trade fair. Printed fabrics with product motifs will be given a second life as bags after the end of the trade fair.

All in all, the booth is 70% recyclable and consists largely of rental items and objects that will continue to be used at ERCO after the trade fair. A statement against the throw-away mentality and in favor of durability. ■

LEDVANCE

www.ledvance.com | Hall 3.0, D10

Under the motto of “POWER THROUGH LIGHT”, world-leading lighting provider LEDVANCE will be showing its intelligent and efficient lighting and energy solutions for anyone who wants to use the power of light – for a greener planet and a better life. LEDVANCE customers can discover the full potential of light not only in professional LED solutions for a wide range of applications or in the pioneering VIVARES light management systems – with a completely new photovoltaic range, the company is now expanding its services to include renewable energies. And LEDVANCE uses the EVERLOOP and NATURELOOP product lines geared toward an effective circular economy to position itself as a pioneer for sustainable, energy-efficient and environmentally friendly LED luminaires and lamps.



LINEAR INDIVILED with EVERLOOP product line for circular economy.

The new era of LED lighting is reflected in innovative solutions in LEDVANCE's core applications – office, industry, logistics, street and sports. Regardless of their use, all LED products are designed to meet clear requirements. They have to be sustainable and energy-saving, user-friendly and easy to install, handle and maintain, highly efficient and customizable. The high quality of light and low glare of the PANEL and LINEAR INDIVILED luminaires meet the expectations of modern office lighting. To satisfy demands in the industrial sector, LEDVANCE offers robust and durable luminaires with high IP/IK protection. In addition to the HIGHBAY luminaires, this includes the new high-performance LED tubes for particularly challenging areas. Outdoor conditions require

lighting solutions that are highly efficient, durable and standard-compliant such as the STRETLIGHT FLEX luminaires or the varied BULKHEAD portfolio with Power Select and IP65 protection. And in sports venue lighting, LEDVANCE offers versatile LOWBAY FLEX luminaires with optional ball-proof covers and LED solutions that are tailored to the customer's requirements as part of the SPECIFY program, such as the FLOODLIGHT ARENA stadium floodlight.

Light management VIVARES

In times of high energy prices, efficient and demand-oriented lighting control is important. With VIVARES, LEDVANCE presents a wide range of DALI and Zigbee-based light management systems that are easy to install and operate, and provide energy and CO2 savings of as much as 80%. LEDVANCE offers VIVARES for single room solutions (up to 200 m²) as an individually designed light management system or for floor solutions (up to 1,000 m²) across multiple rooms, including optional cloud embedding with a remote maintenance option. The systems work either with the established DALI-2 industry standard to operate up to 1,000 luminaires and 1,000 input devices, or the Zigbee 3.0 wireless standard to communicate with up to 200 compatible devices. LEDVANCE offers control units, luminaires, lamps and sensors from a single source, simple configuration and commissioning, individual support from lighting planning to on-site instruction, as well as comprehensive after-sales service.

Photovoltaic solutions

In LEDVANCE Renewables, the company is presenting a product range beyond classic lighting for the first time, positioning itself as an innovative one-stop shop for photovoltaic systems. The photovoltaic solutions are designed for private and commercial applications, with all the individual components perfectly matched to one another. The photovoltaic panels come as bifacial or monofacial modules, with power levels from 405 to 660 W and in various designs. The robust, highly efficient and intelligent string or hybrid inverters are compatible with all system components and are easy to install and operate. The various low-voltage and high-voltage batteries provide optimal performance and energy storage that can be expanded at any time using modules. And the LEDVANCE Renewables app allows

users to monitor and control the system from any location at any time. LEDVANCE's technical support helps customers to get the most out of the system – from initial consultation, delivery and installation to power and energy monitoring.

Under the new umbrella brand of LEDVANCE LOOP, LEDVANCE is consolidating all the new developments and actions for greater sustainability, pushing forward the transition from linear to circular processes. The results of this strategic realignment are the two new product lines EVERLOOP and NATURELOOP. EVERLOOP is the name for luminaires with easily replaceable LED light sources and drivers. Replacing individual components maximizes the luminaire's life and promotes a functioning circular economy. LINEAR INDIVILED, DAMP PROOF and SURFACE FLAT are the first luminaires in the EVERLOOP series. The NATURELOOP label stands for lamps and products that are manufactured and packaged using recycled materials. Each LEDVANCE lamp with a NATURELOOP label contains at least 40% recycled plastic (based on the plastic content of the product). What's more, NATURELOOP packaging is fully recyclable. Awards such as ECOVADIS Silver and a broad set of environmental product declarations acc. to PEP underline this commitment. ■

Zumtobel

www.zumtobel.com | Forum 0, A10

Zumtobel will present human-centric, integrated lighting solutions at its stand in Forum Messe Frankfurt (Forum 0 / A10) at this year's Light + Building trade fair. Digital services and innovative lighting controls aimed at improving well-being in the workplace and supporting sustainable and energy-efficient building operations will be featured alongside lighting for areas of application such as Retail, Office and Industry. And in a 'concept space', Zumtobel will also showcase new product developments and its vision for the lighting of the future.

Spotlighting the key themes of sustainability, digitalization and innovation, Zumtobel and partners will present the lighting of the future at Light + Building 2024, with a focus on

CREE LED cree-led.com

J Series® JB3030C White LEDs

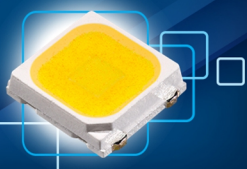

Cree LED J Series® JB3030C White LEDs – top-tier LED efficacy

J Series® JB3030C White LEDs feature LED efficiency up to 242 LPW or 3.33 PPF/W typical. The E & F Class performance options provide a performance boost for high efficacy lighting in outdoor areas, harsh indoor environments and horticulture applications.

These versatile LEDs are footprint compatible with 301B/H, have available LM-80 data, color temperatures (2700-6500K) and CRIs (70-80-90).

CREE LED

www.cree-led.com

Beyond Illumination, Better Living

EDISON OPTO LED steps into an evolution of light quality and transforms illumination for a healthier living space.

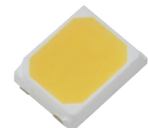

2835

- Full Spectrum CRI95, Ra>97
- Low Blue Light Hazard RG0
- 490nm Circadian Light
- MDER equivalent to sunlight

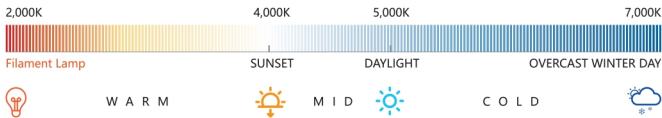

WARM MID COLD

meet EDISON OPTO @Hall 8.0 E70

www.edison-opto.com.tw

service-eng@edison-opto.com.tw

light+building

3. – 8.3. 2024
Frankfurt am Main

shared values and goals that make a tangible difference. At the trade fair stand, visitors will also be able to discover Zumtobel's new lighting solutions for various areas of application.

DC luminaires for industry

TECTON DC is an innovative solution for industrial applications. The DC luminaire is one of the first of its kind anywhere on the lighting market and makes a valuable contribution to sustainability. As a continuous-row lighting system, the luminaire not only reduces energy consumption by two to four per cent compared with AC models, but can also be easily integrated into existing DC infrastructures. This enables companies with self-sufficient DC grids to continue working in the event of a power failure, as the electricity produced on site from renewable energy sources provides an extremely stable and secure power supply.

Specific requirements in the modern office

'Space flexibility' has emerged as a critical factor in the Office segment. The modern office must be able to adapt to a wide range of needs in order to create a productive working environment and a space for dynamic communication. A flexible layout combined with adaptable technologies allows the office to be optimized for collaboration, focused work and many other individual needs. At its stand, Zumtobel will use the ARTELEA

free-standing office luminaire to demonstrate how lighting can complement the concept of 'space flexibility'.

Acoustics also play an important role in the office. In the open-plan areas with numerous reflective surfaces made of glass or concrete commonly found in modern offices, even a phone or video call can result in a sudden increase in noise levels. Zumtobel will use CIELUMA and TRAMAO to show how sound-absorbing materials can be integrated into luminaires to ensure more comfortable volume levels in the office.



ARTELEA, Zumtobel's slimline free-standing office luminaire, adapts to a wide range of New Work scenarios, combining an understated appearance and high luminous fluxes in a luminaire that is both timeless and future-proof. Photo credits: Zumtobel.

As a special highlight, the part of the stand dedicated to the Office segment will be remodeled daily after the trade fair closes, meaning visitors can expect a new display every day.

Energy to Light Quality

Zumtobel is making an important contribution to sustainability in the retail sector with the help of its key concept 'Energy to Light Quality'. The new deep-source reflectors on the VIVO II LED spotlight offer better glare control and deflect more light beams, minimizing scattering losses and efficiently focusing the light on the goods. The design of the reflector, housing and LED holder means that there are no light leaks and that light losses in the spotlight housing are kept to a minimum, with almost 80 per cent of the light beams directed precisely where intended.

Zumtobel will be at Light + Building 2024 at the Forum Messe Frankfurt (Forum 0 / A10) from 3–8 March 2024 together with the other brands of the Zumtobel Group – Thorn and Tridonic – who will also present their portfolios. The stand design plays its part in supporting the Zumtobel Group's sustainability strategy, with many existing elements from the company's Light Forum in Dornbirn being employed, for example, while any new materials used for the exhibition stand will also subsequently be recycled. ■

Tridonic

www.tridonic.com | Forum 0, A10

Tridonic, the technology partner for intelligent lighting, will present its innovative solutions at the Forum (Forum 0/A10) of Messe Frankfurt. Three thematic hubs will focus on integration and operability, outdoor lighting and the comprehensive product portfolio with sustainable LED modules and LED drivers, intelligent controls, software and apps. Live demonstrations will give visitors a haptic experience of the product portfolio. The company will also provide insights into the latest technologies such as Matter.

Integration and Interoperability Hub – Matter and sceneCOM Evo in smart buildings

Matter enables all the lighting, air conditioning and entertainment equipment in a hotel room to be controlled from your own smartphone and with the same software you use in your own smart home. The standardized open source language for seamless communication and collaboration between intelligent devices paves the way for the future of light management. Tridonic is one of the first manufacturers to offer Matter-compatible LED drivers.

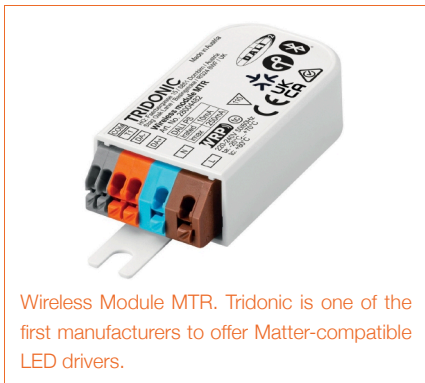

Wireless Module MTR. Tridonic is one of the first manufacturers to offer Matter-compatible LED drivers.

Visitors to the Integration and Interoperability Hub will see how Matter makes controlling lighting, home entertainment, shading and air conditioning in a hotel room easier than ever. The demonstration highlights a Matter feature that will be available in the near future, namely temporary access to Matter environments, such as hotels and co-working spaces.

The floor plan of an office building with various luminaires shows visitors how the versatility of the scalable sceneCOM Evo DALI-2 control solution in handling complex interior lighting. The holistic solution also integrates outdoor lighting close to the building and emergency lighting. A dashboard visualizes the lighting technology installed in the building and provides functionality for basic configuration, simple device monitoring, system control and system maintenance.

Sustainable LightCycle Hub – live demos of sustainable products

Sustainability is the biggest driver of innovation in the lighting industry, so Tridonic is addressing current market demands for intelligent technologies to reduce greenhouse gas emissions and improve the energy efficiency of illumination in buildings and public spaces. The company is focusing mainly on lowering the consumption of natural resources and increasing the energy efficiency of its products. The technologies take into account all aspects of sustainability throughout the product lifecycle. As proof, Tridonic is the first company in the electronics industry to achieve simultaneous Cradle to Cradle certification of LED drivers and LED modules.

At the Sustainable LightCycle Hub, Tridonic will be showcasing a new feature of the GEN4 drivers, namely lifetime analytics. Visitors can read out the driver data and gain valuable insights into the remaining service life and past events such as overheating. This means that drivers with a high residual life can be used a second time in the interests of sustainability. Damage due to environmental influences is detected in good time so that it can be avoided in the future. Visitors to this hub can also get to know the comprehensive range of Tridonic products. The product groups provide an attractive overview. LED modules and drivers can be selected from various trolleys, and experts will be on hand to discuss appropriate solutions based on those selections.

Urban Innovation Hub – intelligent outdoor lighting in the city of the future

Modern outdoor lighting in towns and cities helps to achieve sustainability targets based on such things as saving energy and reducing light pollution. In the urban space of the future, however, lighting will go one stage further: it will think for itself. Integrated sensors will detect the current traffic situation and control adaptive lighting scenarios so that, for example, lighting levels on streets and paths can be dimmed in off-peak times and increased again as traffic flows increase. Intelligent outdoor lighting will enable traffic flows to be measured and analyzed, right down to the type of vehicle. This will pave the way for smart planning and control of traffic in real time and intelligent parking management.

At the Urban Innovation Hub, visitors can install various sensors and modules in luminaires and immediately see the results for lighting control, energy consumption, service life and payback time. A smart city is where the possibilities of smart outdoor lighting for optimized public infrastructure management and traffic optimization become real. ■

PHABULOU

<https://phabulous.eu> | Hall 8.0, G83

PHABULOU specializes in producing free-form micro-optical components to enhance light forming efficiency and optimize compactness. The benefits of free-form micro-optics in lighting technology include improved efficiency, color mixing, customizable light direction, and global lighting uniformity—all while prioritizing compactness.

At the upcoming Light+Building, they will invite visitors to closely examine recently released pilot cases. These include an LED-Downlighting use case designed by Zumtobel Lighting and headlamps created by PHABULOU in collaboration with FORVIA-HELLA. The booth will also showcase advanced FMLA capabilities, creating micro-structured foils and panels with a gemstone appearance developed for Swarovski. Additionally, there will be a sample from Seisenbacher demonstrating the possibility of miniaturizing optical systems of trains and busses for transportation. PHABULOU serves as the European one-stop shop for manufacturing free-form micro-optics, providing accelerated innovation and production cycles from prototypes to piloting and large-volume production. All their partners are based in Europe.



PHABULOU produces free-form micro-optical components. Image: Zumtobel Lighting GmbH.

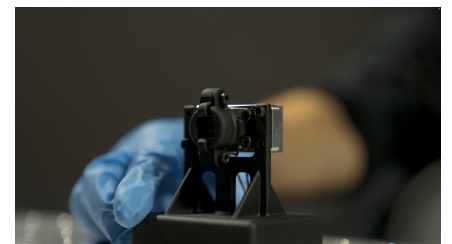

Automotive lighting applications from Hella-Forvia.

Zumtobel Use Case

Zumtobel Lighting GmbH, an internationally leading supplier of integral lighting solutions, has developed special diffusers for color mixing in a downlight using Free-form micro-lens arrays (FMLAs). These FMLAs prove to be more cost-effective, thinner, and lighter than reflectors, showcasing their potential to efficiently produce asymmetric light distributions and uniform illuminance patterns. Watch the video of the use case here <https://youtu.be/yeaP6TBA0sQ>.

CIE Illuminant LEDs

Breakthrough spectral simulations with CIE standard illuminant for accurate lightings

Features

- CIE Standard Illuminant A, E, D50, D65 spectral simulators
- CIE Standard Illuminant LED-B1-B5, LED-V1-V2 coming soon
- Ultrabroad spectral coverage of 380nm-1000nm
- Ultra high Spectral Accuracy Index (SAI) up to 95
- LpS Digital 2023 Annual Innovation Award winner

Applications

- Sunlight luminaire (CIE A, D50, D65)
- Imaging (CIE A, E, D50, D65)
- Color and appearance assessment (CIE A, D50, D65)
- Colorimetric/Medical instruments (CIE A, E, D50, D65)
- Photometric instruments (CIE A)

Hall **8.0**
Booth **A69**

light+building
3.-8.3.2024
Frankfurt am Main

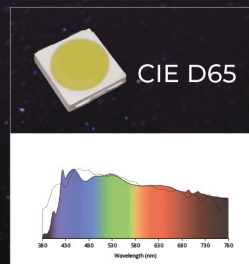
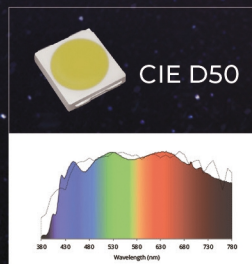
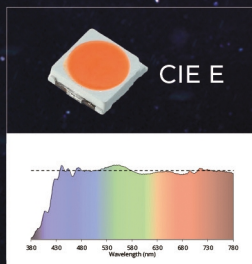
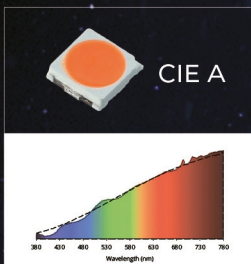
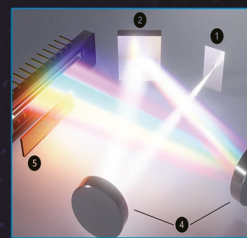
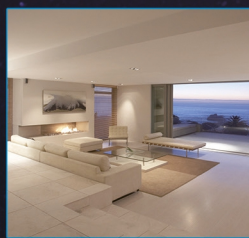

Learn more:
info@yujigroup.com
www.yujiintl.com

©2024 Beijing Yuji International Co., Ltd.



HELLA-FORVIA Use Case

HELLA, operating under the overarching umbrella brand FORVIA, a leading automotive supplier worldwide, presents a use case in the PHABULOU S project. Free-form micro-lens arrays (FMLAs) offer aesthetics, potential for space and weight reduction, and low-cost manufacturing. HELLA's insights into automotive market requirements have led to significant steps in developing a free-form micro-optics-based solution. Watch the video of the use case here https://youtu.be/IYWU1_K-PYY?si=OZQ5eGV21XO21IlgY.

Swarovski Use Case

Swarovski, the renowned company specializing in luxury crystal jewelry, accessories, and decorative items, collaborates with PHABULOU S to explore the application of free-form micro-optics. This partnership aims to create large sparkling surface foils and panels with high brilliance. Free-form surface micro-structuring not only enhances brilliance but also expands design freedom. The high-quality and cost-effective large-area replication technologies offered by PHABULOU S show great promise for such applications.

SEISENBACHER Use Case

SEISENBACHER, a global provider of interior solutions for the railway industry, works on the next generation of luminaires with integrated free-form micro-optics for various means of transport. The goal is to develop ultrathin luminaires or those with a significantly reduced number of LEDs, along with a customized shape of the illumination pattern. The demonstrator within the PHABULOU S project shows promising progress in miniaturizing optical systems for interior lighting applications.

About PHABULOU S: PHABULOU S is the European Pilot Line for the manufacturing of free-form micro-optical components. They provide highly advanced & robust manufacturing technology for optical free-form micro-structures. ■

IQS NANOPTIQS

www.nanoptiqs.com | Hall 8.0, C61

IQS NANOPTIQS, a pioneer in nanotechnological light solutions, is redefining the landscape of LED optics with its cutting-edge products, including the acclaimed IQ System. By harnessing the power of micro and nanostructures, IQS NANOPTIQS is leading a revolution in creating thin, miniaturized, and highly efficient optical solutions, unlike anything achieved by traditional production methods.

IQS NANOPTIQS employs its proprietary technology to develop a wide range of optics that leverage the benefits of nanotechnology.

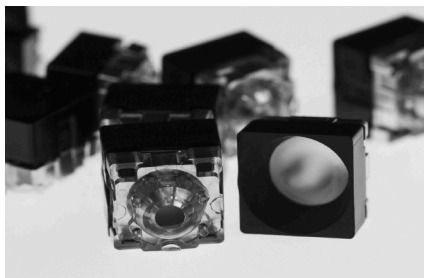

IQ System from NanoOptiqs. With multiple light distribution options and design possibilities only limited by your imagination, the IQ System is a full package for all your accent lighting needs.

This includes the IQ Linear family, designed for a broad range of linear LED fixtures, and the versatile IQ System, focused mainly on architectural lighting applications. These products stand out for their enhanced visual comfort, remarkable level of miniaturization, and precise light control.

The company's nanostructured optics allow for significant reductions in luminaire weight and size, leading to more sustainable and material-efficient lighting solutions. A luminaire built with IQ System, for instance, weighs less than 135g per meter yet delivers over 20 lumens per gram of luminaire weight, setting a new standard in the industry. ■

Covestro

www.covestro.com | Hall 8.0, A39

Makrolon® polycarbonates enable the manufacturing of energy-efficient optical parts for LED luminaires. Whether for diffusers or reflectors in luminaires, thermo-conductive heatsinks, ultra-transparent lenses or light-blocking components – the material portfolio offers you all the building blocks for lighting innovations.

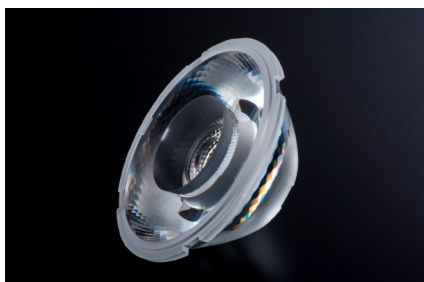

Makrolon® LED: Upmost transmission (> 90%) to improve efficiency for transparent luminaire covers, lenses, light guides or other optics.

The wide range of Makrolon® products meets the needs of luminaire manufacturers when it comes to creating energy-efficient lighting solutions that are both sustainable and effective. Depending on the application, this requires high lumen efficiency per watt, light guiding, thermal conductive properties, flame retardancy or a multifunctional design.

The Covestro portfolio includes transparent, translucent, reflective white, light blocking, thermal conductive and flame-retardant materials:

- Makrolon® LED: Upmost transmission (> 90%) to improve efficiency for transparent luminaire covers, lenses, light guides or other optics.
- Makrolon® DQ: Three levels of translucency with maximum transmission, offering the individually suitable hiding power for all luminaires.
- Makrolon® RW: Ideal surface for reflectors in aesthetic white with up to 97% diffuse reflection in all directions. Easy for the eyes without glare and available as a light-blocking variant to avoid light leakage.
- Makrolon® TC: Maximized thermal conductivity for plastic solutions, enabling the replacement of metals in heat sinks with less weight, more design freedom and energy-efficient production.
- Makrolon® FR: Flame retardant variants of Makrolon® LED, DQ, RW and TC products for high demands on light and safety. Special solutions also for the high requirements in rail, aircraft or other public transport applications.

Sustainability is a central aspect of Covestro's strategy. The polycarbonate solutions for lighting applications enable energy-efficient and long-term stable systems with significantly lower weight than glass or aluminum products. In addition, alongside fossil-based production, the polycarbonates for lighting applications are also available as Makrolon® RE grades. These are manufactured using raw materials from mass-balanced biowaste and residual materials, as well as renewable energy, and enable identical quality with significant CO₂ savings. Makrolon® polycarbonates offer a great deal of diverse lighting solutions for more efficiency and design freedom. ■

Nichia

www.nichia.co.jp/en/ | Hall 8.0, D60

Nichia, the world's largest LED manufacturer and pioneer of high-brightness blue and white LEDs, will highlight several class-leading products at Light + Building 2024. The focus of Nichia's exhibition this year is to transform the quality and form of lighting.

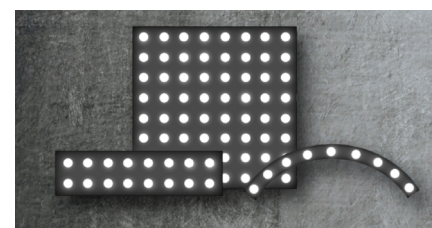

Nichia's wide directly technologies: Light Cluster™ Type L.

Join UL Solutions lighting experts at the Light + Building 2024 show

At Frankfurt, March 3-8.
We are located at G79, Hall 8.0.

[UL.com/lighting](https://www.ul.com/lighting)



Safety. Science. Transformation.™

Quality of Lighting: Nichia's lighting enhances people's lives by making illumination more vivid, supporting good sleep and active lifestyles promoting better health. It also supports the elderly's well-being, improving societal impact.

Form of Lighting: Moving beyond conventional lamp replacement lighting, Nichia's latest solutions enable sleeker, lighter, and more compact luminaires, leading to efficient, eco-friendly lighting solutions. This paves the way for a more sustainable, circular economy.

For instance, a series of LEDs on display deliver unrivalled sharpness and high-fidelity color reproduction along with high efficacy. The products are ideal for indoor settings where vivid light quality is paramount, including retail, office, and healthcare settings. Also on show, there is an extensive portfolio of LEDs replacing HPS solutions for street lighting, landscape illumination and parks, as well as an HCL solution that contributes to people's well-being.

Nichia will unveil a new range of LED modules offering unmatched uniformity and glare-free illumination whilst enabling luminaire manufacturers to produce fixtures which are significantly lighter and slimmer. Additionally, Nichia will showcase a high luminous flux density chip scale LED to allow fixtures to be made smaller and the color-mix to be made easier, with the same forward voltage.

Visitors to Nichia's booth can also enjoy several presentations about technology and application trends from industry partners and technical experts at Nichia. ■

GL Optic

www.gloptic.com | **Hall 8.0, H82**

GL Optic has developed the GL OPTICAM 4.0 M SC, a luminance and color measuring device with sequential imaging, for demanding metrological applications in laboratories and industry. With its revolutionary technology, this spectrally corrected RGB camera avoids the shortcomings of previous devices and offers superior application characteristics.

The GL OPTICAM 4.0 M SC is based on a modular technology that integrates a luminance meter and a spectroradiometer in a single housing. It enables the precise and fast measurement of luminance and color parameters for light sources of different sizes, such as LCD display panels or backlit electronic modules. This makes it ideal for light measurement applications in laboratories and industry as well as for regular quality control in production. Other application examples include the characterization of displays on display panels, for example in vehicle cockpits, as well as the general evaluation of luminance and color uniformity of monochrome and color displays. Based on a

spectral correction, the device provides precise x/y coordinates for each pixel. The unique sequential measurement method of the GL OPTICAM 4.0 M SC ensures higher signal levels and therefore better accuracy compared to conventional solutions with basic optical filters or beam splitters. Supported by the super-fast GL OPTICAM Soft 4.0 M software, luminance and chromaticity are analysed at high speed - measurement results are available in less than three seconds.



GL OPTICAM 4.0 M SC, a luminance and color measuring device with sequential imaging, for demanding metrological applications in laboratories and industry.

Other features of the device, such as the built-in depolariser and the 9-megapixel CMOS image sensor in 1-inch format, provide a high dynamic range and ensure that the system is ideally equipped for current and future display measurement challenges. ■



Precise MicroLED in-process inspection

- ▲ Calibrated LumiTop 2D imaging camera system with unrivalled accuracy
- ▲ Parallel testing of thousands or millions of μ LEDs on wafers or in modules
- ▲ Fast and accurate optical inspection on every LED or pixel
- ▲ Easy integration into production lines
- ▲ Fully traceable to national labs

We bring quality to light.

Instrument Systems GmbH
Phone +49 89 45 49 43-58 • instrumentssystem.com

ams OSRAM

www.ams-osram.com | Hall 8.0, F30

ams OSRAM will showcase a unique portfolio of innovative LEDs, spectral and ambient light sensors. Their miniaturized and efficient solutions offer customers infinite design possibilities, greater cost-savings, outstanding performance, and maximum accuracy – at workplaces and at home.

ALIYOS™ LED-on-foil technology
Introducing the new ALIYOS™ technology from ams OSRAM: this innovative LED-on-foil technology enables unprecedented effects in automotive lighting, effects where the light comes almost out of nowhere.

Light-emitting diodes (LEDs)

Light-emitting diodes (LEDs) are semiconductor components which emit light when current flows through them in a forward direction. Electrons recombine with holes in the depletion zone releasing energy in the form of photons. The electrical characteristics of LEDs correspond to the electrical characteristics of normal diodes. ams

OSRAM's comprehensive LED portfolio covers a vast array of diverse needs, applications and advanced technological solutions. Our technology offers highly efficient LED with improved color quality and durability. Pixelated LED technology: pixelated light sources enable simultaneous visualization and illumination in a single component.

3D time-of-flight (ToF) sensing

Highly accurate distance measurement and 3D mapping and imaging: low-power time-of-flight sensing technology from ams OSRAM enables host systems to measure distances accurately and at exceedingly high speed. Accurate distance measurements are used in various applications including presence detection, human facial recognition and advanced cameras. ams OSRAM 3D direct time-of-flight (dToF) technology for smart phone world-facing cameras aims to achieve a higher range and lower power consumption than other implementations. To minimize integration effort for mobile-device OEMs, our 3D dToF system provides a complete technology stack – from optical sensing through to scene reconstruction and integration with an RGB camera.

ams OSRAM chip-packaging technologies

Chip-packaging technologies developed by ams OSRAM help our state-of-the-art optical devices and sensor products to achieve extreme high precision, low noise performance and reduced system costs. Advanced packaging technologies from ams OSRAM include: * Wafer-level optics, which enable the precise fabrication of lenses for miniature light sources and detectors. * Through-silicon vias, which radically reduce the height of an optical IC package and eliminate the need for wire bonds. * System-in-package (SiP) technology – ams OSRAM integrates complete sensor assemblies into a single SiP to save space and eliminate a board assembly process for customers. * Stacked dual die – wherever reliability is a must, ams OSRAM offers fully redundant solutions with two of the same sensor dies in a single IC package.

Capacitive sensing

Capacitive sensing is a widely used technology in human presence detection, fluid-level sensing or hands on detection for autonomous driving. It works on the principle of capacitance: charge accumulates in the gap between two sheets of metal, or 'electrodes', when a voltage is applied to one electrode. The amount of charge which accumulates depends on a property, the 'permittivity', of the material between the electrodes. At the heart of the capacitive sensor measurement system is a type of capacitive sensing technology called I/Q demodulation. This method measures the resistive as well as the capacitive element of a system's impedance. The effect of this is that, unlike other methods for capacitive sensing, it

works reliably even in difficult conditions, and is sensitive to small changes in resistance.

CMOS imaging

ams OSRAM continuously develops new technology to improve the performance of its CMOS image sensors. These technology improvements support both custom CMOS image sensor developments and standard, off-the-shelf CMOS image sensor products.

Position sensing technologies

Unique technology developed by ams OSRAM protects position sensors from interfering magnetic stray fields and reduces angle error so that – despite often harsh environments – they operate with accuracy and reliability. * Stray-field immunity: ams OSRAM position sensors feature a unique technology which protects them against interference from magnetic stray fields. The sensors overachieve ISO 11452-8, which specifies tests for the electromagnetic immunity of electronic components to magnetic fields for passenger cars and commercial vehicles regardless of the propulsion system. * Dynamic angle error compensation (DAEC™): DAEC™ is a revolutionary recent technology that yields almost zero output latency and ultra-fast refresh rates in high-speed motor control systems. * Coil design: the inductive position sensor technology is based on measuring the coupling between the coil (excitation and receiver coil) via rotating target. Due to its flexibility, easy adaption and low overall system costs, inductive position sensing acts as the perfect resolver replacement and can be used for on-axis as well off-axis applications. * PSI5 interface: PSI5 is a standard bus which enables communication between devices in an automotive system over a twisted-pair cable.

Spectral sensing

By shining light on or through objects and by looking at the reflected or transmitted spectrum, a sensor system can detect or classify what it is looking at.

Advantages of ams OSRAM spectral sensing technology: * Interference filter technology for durability and spectral stability over time and temperature. * In-house filter manufacturing and testing capability. * In-house module design and manufacturing capability including Detectors, Light source, Light path, and Optics.

VCSELs for flexibility and reliability

Vertical-cavity surface-emitting lasers (VCSELs) have various advantages over other types of lasers. These include: * surface emission, which offers design flexibility in addressable arrays. * low temperature dependence of the lasing wavelength. * superior reliability. * a wafer-level manufacturing process.

ams OSRAM VCSEL technology includes the epitaxial structure and chip design, epitaxial

Love for light.
90 years of PLEXIGLAS®.

Exactly 90 years ago, PLEXIGLAS® – the original by Röhm – came into being. And now it is younger than ever. Our experts are constantly reinventing PLEXIGLAS®, improving its performance with every new generation – for inventive light applications, brilliant colors, durable surfaces and creative design. The result of this decades-long evolution: PLEXIGLAS® is more desirable at 90 than it was at 20. Send your birthday wishes to www.plexiglas-polymers.com.

R
90
PLEXIGLAS®

PLEXIGLAS®

THE ORIGINAL BY RÖHM



RÖHM

growth, front- and back-end processing, packaging and advanced testing and simulations. ams OSRAM VCSELs are rated for operation at ambient temperatures as high as 150°C.

Infrared LEDs for invisible applications

Infrared illumination plays a significant role in the broad fields of industry, automotive and consumer applications: CCTV, biometric identification, driver monitoring, machine vision to name only a few. With a long history in developing infrared LEDs, ams OSRAM is the industry leader in this technology, offering a range of products to match the varying requirements of each application area: * wall-plug efficiencies well above 50%, based on ams OSRAM's thin-film technology, * low operation voltage and extremely high-power ratings/low thermal resistance, * wavelengths of 850nm and 940nm, * various beam angles, and * Single- and dual junction (stack) chips.

Continuously expanding and improving the IR LED portfolio, ams OSRAM is well-positioned to remain the market leader in infrared illumination.

Edge-emitting lasers (EEL)

ams OSRAM leads in visible and infrared edge-emitting lasers (EEL) technology for sensing, visualization and material processing. Edge-emitting lasers use nanostack technology (e.g.: triple-junction: three light-emitting surfaces (pn-junction) stacked one on top of the other), which has the main advantage of delivering high power within a small area (small size), making it the technology of choice for long-range LiDAR, visualization, illumination and material processing.

Infrared laser diodes for sensing (LiDAR applications) with wavelength of 905nm have the highest efficiency on the market. The laser diodes can operate with extreme short pulses (down to 2nsec), while delivering outstanding power.

Visible InGaN laser diodes for laser projection and illumination have a great optical output power at high operating temperature range. Single-mode laser diodes can operate at a higher temperature range without active cooling and have excellent efficiency, which can extend long life.

High power performance with multi-mode laser diodes are the best fit for industry and automotive applications.

Micro-lens arrays (MLA)

Micro-lens arrays (MLA) operate as ultra-small projectors which have images integrated into the micro-optic lens, producing sharp images in brilliant color. Micro-lenses offer a long focal depth, which means that an array can project a focused image on to a parallel, slanted or curved surface.

Micro-lens arrays may be configured to provide a bright output in an extremely low-profile form factor. In conventional projector technology, the higher the brightness required, the larger the projector. By contrast, micro-lens arrays can be arranged next to each other so that their images overlap to create a brighter picture, while the thickness of the projector, typically 3mm, remains the same.

Micro-lens array technology from ams OSRAM used in the automotive sector and in various non-automotive applications. ■

Lambda Research

<https://lambdaresearch.com/> | Hall 8.0, H86

Lambda Research Corporation is pleased to announce the latest release of its flagship product, TracePro. This TracePro 2023.5 release contains an exciting new feature as well as many enhancements and improvements to existing features and tools.

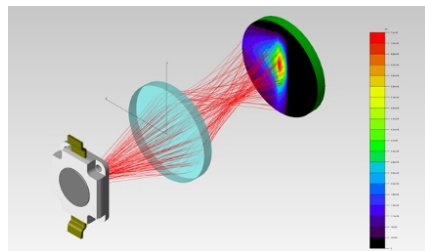

CGH lens to produce complex illumination pattern from flat, thin optic.

Users can now model DOEs (diffractive optical elements) in the TracePro Standard and Expert editions. Three new Surface Property types are available for modeling DOEs, Holographic Optical Element (HOE), Computer Generated Hologram (CGH), and Zernike phase. The Computer-Generated Hologram surface can be Radially symmetric, Asymmetric x-y, or Asymmetric (absolute value). Many of their users have requested this capability and it is now available in TracePro.

Diffractive optical elements allow for compact, lightweight, and innovative solutions to optical design challenges. DOEs can be used in illumination, display, and many other applications. Many of their users have requested this capability and it is now available in the Standard and Expert editions of TracePro. TracePro also features many other features that are invaluable for lighting and illumination design, including optimization, accurate source modeling, a full set of analysis tools, and easy learning curve, and CAD import and export capabilities.

Stop by at Lambda Research's booth to check out TracePro as well as RayViz, their ray tracing Add In for SOLIDWORKS. ■

Light + Building 2024 Attracts over 2,000 Exhibitors

The countdown is on before the doors open on the world's leading trade fair for lighting and building-services technology in Frankfurt am Main in March 2024. And this major event for the sector is already proving to be very popular. To date, more than 2,000 national and international exhibitors have registered to present their innovations to a wide audience of trade visitors. They include numerous market leaders who will be showing their latest products for the fields of lighting, electrical engineering, home and building automation and networked safety and security technology.

The next Light + Building will be held as usual in the early spring, from 3 to 8 March 2024, and registrations have already been received from more than 2,000 exhibitors. After Germany, the best represented nations to date include Italy, Turkey, Spain, Poland, the Netherlands, Great Britain, France, Belgium, Greece and China. "There is a high level of interest in taking part again in 2024, on both the lighting and building sides. We are delighted about the many loyal customers who took part in the last edition of the fair, as well as about a whole series of returning exhibitors. They all ensure that Light + Building is the unrivalled, international highlight for the lighting and building-technology sectors", says Johannes Möller, Head of Light + Building Brand Management. Expanding on this, he adds: "There have been some changes at the Exhibition Centre, which have opened up new planning options for us."

Experts for lighting with a new structure

Covering the spectrum from offices and educational facilities to the industry, retail trade and hotel business, Light + Building brings together experts for intelligent lighting solutions at Frankfurt Fair and Exhibition Centre. Altogether, this theme occupies around 64 percent of total exhibition space. New in this connection is the layout of the product segments, which has been made possible by the inclusion of the new Hall 5 with two modern floors that are open to Light + Building exhibitors for the first time. This creates a new circular route in the eastern section of the Exhibition Centre, which runs from Halls 5 and 6, via the Forum and Hall 3, to Hall 4, and is made effortless by the Via Mobile system of moving walkways.

What can visitors expect in which halls?

The market leaders from the 'technical lighting' segment are to be found in Halls 3.0, 5 and the Forum. The exhibitors showing their latest products include Bega, Brumberg, Glamox, iGuzzini, Leds C4, Ledvance, Lichtwerk, Molto Luce, Normagrup, Regiolux, Ridi, RZB, Simes, Thorn, Tridonic, Trilux, XAL and Zumtobel.



LIGHTINGEUROPE
THE VOICE OF THE LIGHTING INDUSTRY

#LB24

Policy Debate

**5 March 2024 in Messe
Frankfurt L+B**

(15:00 - 19:00 CET)



light+building

**The LightingEurope 2030
Strategy & key
developments on
sustainability and
enforcement of rules**

FOLLOW US



JOIN US



**Special thanks to
ZVEI and
Light+Building**

The event will be followed by a cocktail
offered by LightingEurope.

www.lightingeurope.org

Hall 3.1 focuses on decorative and technical, design-oriented lighting with presentations being made, for example, by Artemide, Delta Light, 3F Filippi, Linea Light, Marinelli Luce, Prolicht and Targetti.

Urban lighting for streets and public places will be shown by many companies including AEC Illuminazione, Benito Urban, Carandini, Eclatec, Fonroche, Leipziger Leuchten, Metalgalva, Ragni and Valmont in Hall 4.0. A floor higher, in Hall 4.1, visitors will find not only lighting for industry and special applications but also shop and theatre lighting, as well as emergency and safety lighting. Among the exhibitors taking part there will be Barthelme, Deko Light, Eaton, Inotec, Nobilé, Opple, Robus, Rutek, Radium, RP Group and SG Armaturen.

The complete spectrum of decorative lighting is located in Hall 6 where the exhibitors include Authentage, Elstead Lighting, Fan Europe, Konstsmide, Lucide and Nordlux, plus the companies taking part in the Turkish pavilion.

The lighting sector also occupies part of the western section of the Exhibition Centre and, for the first time, takes up the whole of Hall 8. With the focus there on lighting components, sources of light and lighting control systems, the exhibitors presenting their latest products include Bender + Wirth, BJB, Nichia, Osram, Seoul Semiconductor, TCI, Vossloh-Schwabe and Wago.

Hall 10.1 and 10.2 are devoted to Asian lighting manufacturers in the Asia Selection segment.

Looking ahead with intelligent building-services technology

Based on the electrotechnical infrastructure, tomorrow's sustainable houses and buildings will use renewable sources of energy, have efficient and economical energy management and, at the same time, offer a high degree of comfort, safety and security. The electrotechnical infrastructure is the prerequisite for home and building automation, energy storage and management, the connection of photovoltaic systems and charging stations and electricity-based heating systems. The latest products, technologies and trends for electrical engineering and home and building automation will be the focus of attention in Halls 9, 11 and 12.

Many of the sector's key players have already confirmed their participation in the fair. In Hall 12.0, they include ABB, ABL, Bals, Bosch Thermotechnik, Busch-Jaeger, Dehn SE, Kaiser, Niedax, SMA, Stiebel Eltron, Theben, Viessmann and Warema. A floor higher, in Hall 12.1, the exhibitors will include Doepke, Fränkische Rohrwerke, Hager, Mennekes, Hensel, OBO Bettermann and PCE. ■

INTERNATIONAL NEWS

Revision of EPD Product Specific Rules for Luminaires

LightingEurope supports the successful revision of PEP Ecopassport's PSR0014 for luminaires.

LightingEurope and their members have continuously shown their commitment to sustainability and to the reduction of the environmental impact of lighting products. With the support of LightingEurope experts, the PSR0014 environmental declaration method for luminaires for general lighting has recently been revised, further demonstrating this ongoing commitment. We believe that the PSR0014 rules, published by PEP Ecopassport, can lead the way in further improving the environmental profile of the lighting industry.

With the efforts put in revising PSR0014, LightingEurope is not just responding to the increased interest in the market and among regulators in Lifecycle Assessments (LCAs) and Environmental Product Declarations (EPDs), but it is also providing a viable tool to deliver comparable and verifiable information on the environmental impact of lighting products in a cost-effective way by enabling EPDs per product family. Comparability of product EPDs is enhanced by the introduction of a so-called 'Functional Unit' concept that normalizes impacts based on lumen output and lifetime of a luminaire. The revised Product Specific Rules (PSR) take into consideration the nature and market circumstances of the lighting industry. General lighting luminaires are used in many different application environments and the market consists of an impressive variety of products from various suppliers and manufacturers. The PSR0014 method is comprehensive, mature, and it addresses the diversity of luminaires.

We further strive for PSR0014 to serve as the basis for a standardized set of rules to be established at a global level. In this regard, representatives of LightingEurope Members have already taken the first steps towards standardizing global PSR rules on luminaires in relevant IEC committees. PSR0014 can support the comprehensive and transparent delivery of information on the lifecycle analysis of luminaires and should therefore serve as an essential guide for all EPD operators involved and interested in the creation and application of LCAs concerning lighting products around the world. For more information contact Elena Scaroni, Secretary General LightingEurope. ■

elena.scaroni@lightingeuropa.org

DALI Lighting Awards 2023

Each of the eight categories recognizes the best use of DALI lighting control in projects from around the world. dali-alliance.org/

Architectural & Entertainment: Taking the winners' spot is Tridonic Middle East for the Roxy Cinemas in Dubai, UAE. The intelligent, future-proofed DALI lighting system provided precise control, ease of access and monitoring, with minimal maintenance demands to ensure an uninterrupted movie-going experience.

Healthcare & Education: The winner is zencontrol for its work on The Louisa Martindale Building in Brighton, UK, a new state-of-the-art clinical facility. The DALI-based lighting system comprises over 20,000 assets, and DALI was selected as it fulfilled two essential design briefs, namely access to enhanced diagnostics, and future sustainability.

Industrial: Group Volvo Trucks was named as the winner for the Battery Pack Factory in Gent, Belgium. This project stood out for its use of DALI technologies to improve worker wellbeing, by implementing tunable white lighting across its manufacturing areas.

Infrastructure: Winning the category is Delmatic for its work on Zayed International Airport in Abu Dhabi, UAE. The project is claimed to be the largest DALI control system in the world, with a single site-wide DALI network that manages and monitors 180,000 DALI lamps, 35,000 DALI emergency lamps and 10,000 DALI sensors and switches, all coordinated by 3400 single and multi-universe DALI control modules.

Outdoor: esave AG wins with its Waterfront Lighting project in Fürth, Germany. This small-scale project leverages DALI features including precise dimming, colour control and scheduling to deliver optimal lighting for human eyes, enhanced safety and insect protection.

Residential: Morlights' work at the Ko'ula at Ward Village, Honolulu, USA, took the crown in the Residential category. Morlights relied on DALI technology to ensure light levels and colour temperature suit the varied needs of different spaces, creating a human-centric lighting scheme, with cohesion across the entire venue.

Retail & Hospitality: bluebottle was named the winner for the Ritz Carlton Hotel in Melbourne, Australia. This multi-faceted project utilised intelligent DALI technology across each area of the hotel, including guest suites, to create a sophisticated environment, while also emphasizing ease of use and flexibility.

Workspaces: Completing the award-winning line-up is Shanghai LONTRI for the Estée Lauder R&D Center project in Shanghai, China. The 11,500sq.m site was designed according to the LEED Platinum and WELL Platinum standards and utilises DALI in a variety of ways to reduce energy consumption and improve the employee experience. ■

How DALI Enables Efficient, Future-Proof Lighting Control Systems

Designers, architects and building owners must consider a wide range of lighting-related issues, including sustainability, the circular economy, energy consumption, data and analytics.

Advanced lighting-control systems based on a global standard such as DALI can help to address all these issues.

Whatever the lighting system's requirements, standardization with DALI can deliver an efficient, flexible, sustainable and cost-effective solution.

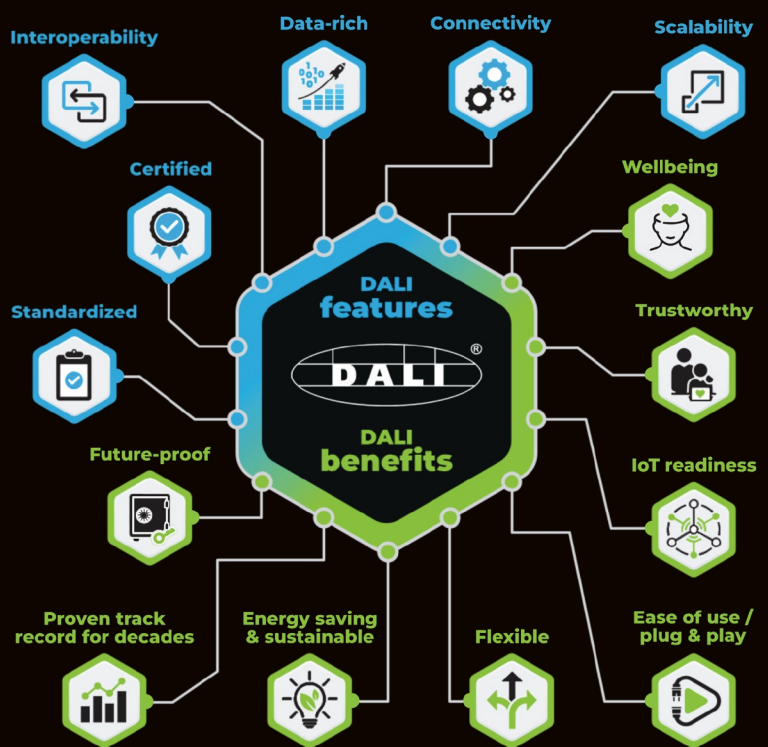

Download our white paper at:

www.dali-alliance.org/downloads

light+building

Meet the DALI Alliance at:
Hall 8.0, D80



Illuminating the Path: A Visionary Journey in Optical Innovation – Jennifer Aspell, CEO of BrightView Technologies

Jennifer Aspell:

“At BrightView, sustainability and energy efficiency are paramount in our LED lighting solutions. Our approach includes continuous improvements in efficiency and product solutions, reflecting our commitment to balancing technological advancement with environmental responsibility.”



In this exclusive interview, we engage with Jennifer Aspell, a luminary in the optical technology realm, as she illuminates the path of BrightView Technologies from its modest beginnings to its current status as a trailblazer in LED lighting and micro lens array technology. With a rich background, combining electrical engineering and business acumen, Aspell's journey through esteemed institutions and leading roles in optical innovation, sets the stage for BrightView's revolutionary advancements. As she recounts the strategic shifts, technological breakthroughs, and adaptive responses to global challenges, we delve deep into the heart of a company driving the future of lighting. Join us as we explore how BrightView's commitment to innovation, quality, and sustainability is shaping the industry, reflecting a relentless pursuit of excellence and an inspiring vision for the future of illumination technology.

www.BrightViewTechnologies.com

LED professional: Thank you very much for taking the time for this interview. Could you begin by sharing your educational and professional background, and how it led you to your current role at BrightView Technologies?

Jennifer Aspell: I have a B.S. in electrical engineering from Rensselaer Polytechnic Institute, an M.S. in electrical engineering from the University of California, Berkeley, and an MBA from Purdue University's School of Business. I have spent my entire career in optical technology. I started my career as a product development engineer in undersea fiber optic communications at Bell Labs, where I quickly realized I had a unique talent for commercializing a laboratory concept and bringing it to the market. I advanced into an executive role at Bell Labs where I grew a research idea into a large business unit. I left Bell Labs for a role at JDS Uniphase, where I ran the optical Amplifier business unit and grew it from a prototype to a very successful business. After that I led a product management effort at Tyco Electronics before joining BrightView Technologies.

LED professional: How has BrightView Technologies evolved over the past decade? What have some key milestones in this evolution been?

Jennifer Aspell: Ten years ago, BrightView was a small business unit in a public company. We had about 20 people located in Durham, North Carolina, and our focus was on developing optical

components for the LED lighting market. In 2018, we made the strategic decision to build on our foundation in the LED lighting industry and enter new markets, such as advanced display and 3D image sensing, where our technology could solve difficult problems.

Shortly after, the 2020 global pandemic hit. Based on our material supply and manufacturing capabilities, we swiftly pivoted to producing face shields for front line workers. At the end of that tumultuous year, we spun out of the public company into a standalone, private company owned by the employees and our growth investor, Technology Venture Partners. We embarked on a major renovation and expansion of our manufacturing facilities with more clean room production so that we could better serve our rapidly growing markets of display, automotive, AR/VR and 3D sensing while maintaining our foundation in LED lighting. On this journey, we've grown to more than 50 employees, formed a UK subsidiary, hired a global sales team, added a sustainability team and expanded our patent portfolio.

These key milestones underscore our dedication to innovation, customer satisfaction and operational excellence to address high growth markets with our world-class micro lens array (MLA) technology.

LED professional: Could you elaborate on the technological advancements that have been pivotal in BrightView's success in shaping and diffus-

ing light? How have these advancements influenced the industry as a whole?

Jennifer Aspell: Our position as the leader in MLA technology is based on our proprietary, one-of-a-kind, in-house gray scale photolithography MLA system, E2. E2 underpins our ability to craft highly complex MLA designs, thereby providing unlimited design freedom to product developers. Our E2 system can create MLAs that combine multiple functions, such as splitting and tilting the light, into a single component. With our world-class optical design team, companies can count on BrightView for industry-leading solutions to the most challenging optical problems.

In addition, BrightView has the ability to be material agnostic and create microstructures on anything from PET to PC to glass in very large formats – as large as 12 square feet. Our E2 technology provides incredibly fast design iteration and prototyping capability (think days instead of months). When an industry is undergoing disruption, this ability to iterate quickly speeds the time to market for our customers. No one else in the industry can approach this speed.

Finally, our design teams and production lines are co-located here in North Carolina under our control, allowing us to go from the lab to the factory floor almost instantaneously. Our mass production roll-to-roll capabilities underscore our commitment to scalability, ensuring that these technological advancements ben-

efit a wide range of applications and industries – further solidifying our position as industry trailblazers.

LED professional: In the diverse fields of Micro Lens Arrays, Automotive, Display, and Lighting, which technologies or projects have been particularly unique or challenging for BrightView?

Jennifer Aspell: One of the most challenging product innovations has been creating a “zonal diffuser” that is tailored to a customer’s unique requirements. In a zonal diffuser, there are defined areas (or zones) in the component that provide different beam shaping. For example, think of a ring of different diffusion levels centered on an LED. This is our lattice diffuser which improves uniformity and brightness in mini-LED display architectures. Zonal diffusers require highly precise and accurate optics and combine multiple functions across zones. Our E2 technology is uniquely suited to creating this type of component.

LED professional: Could you walk us through BrightView Technologies’ design process, starting from the moment you receive a client’s requirements to the point where a finished optical solution is developed? Would you also shed some light on the design tools and technologies utilized during this process?

Jennifer Aspell: Our design process typically begins with a deep dive into the optical functionality required by the customer. Rather than specify lenses, our world-class optical design team asks the client to outline the optical input and desired optical output. Then we use our in-house, proprietary software to take these high-level functional requirements and create a DOE for the MLAs. Once the DOE is transferred to our E2 gray-scale photolithography system, we create a matrix of test blocks (or prototypes). What is unique about our process is that our speed allows us to design empirically and experimentally rather than just using simulations. We can often create prototypes faster than we can simulate in software, such as LightTools.

After measuring the optics of the test blocks and providing multiple samples to our customer, together, we select a final design and create a full-size primary tool using our E2 system. Using our post-

processing steps, we create generational tooling from this primary tool to ensure long-term consistency and stability in the process. The generational tool is then used on our large scale, roll-to-roll photoreplication line to create the final mass production product. From start to finish, this process can take as little as five to seven days, but typically, it takes a few weeks to go from concept to production.

Transparency and communication are fundamental as we keep clients informed at every stage, ensuring a seamless transition from concept to a fully realized optical solution that not only meets, but exceeds their expectations.

LED professional: Can you provide an example of a customer project that transformed a client’s design concept into a new reality? How did this project reflect BrightView’s innovative capabilities?

Jennifer Aspell: We work with customers on cutting-edge designs every day. As our interactions with customers are confidential and proprietary, I can address this question at a high level. Sometimes, customers ask us for two components – one to spread the beam, and the other to tilt the beam. Our advanced technology allows us to combine that functionality into one film that both spreads and tilts the light. By eliminating a component in its module, we provide



MLAs are ideal for color mixing, wall grazing and beam control in highlighting outdoor architectural features ranging from surface textures and molding details to archways and windows.



MLAs provide the visual intelligence capabilities needed to enhance the efficiency, durability and versatility of lighting displays inside and outside of vehicles.

significant advantages to the customer: our design is more cost-effective, our design improves performance by minimizing transmission losses, and our design is more sustainable by reducing polymer content in the final product.

LED professional: How does BrightView address sustainability and energy efficiency in its LED lighting solutions? Are there any specific initiatives or practices at BrightView that contribute to environmental conservation? How do you balance technological advancement with environmental responsibility?

Jennifer Aspell: At BrightView, sustainability and energy efficiency are paramount in our LED lighting solutions. With a dedicated focus on carbon management, material circularity and social fairness, our approach includes continuous improvements in efficiency and product solutions. Notably, our thin film solutions can yield greenhouse gas savings exceeding 83%, and display film solutions contribute to a 10% to 30% brightness improvement, translating to direct energy savings in mini-LED and edge-lit displays. We prioritize responsible material disposal through partnerships with Terracycle, ensuring select materials are recycled, and our commitment extends to packaging materials with biodegradable and recyclable options. As part of our social fairness pillar, we engaged in faceshield production during the early stages of COVID-19, providing employment to affected community members. Our community service team conducts quarterly donation drives and outreach activities, reflecting our commitment to being a fair workplace and responsible community member, thus seamlessly balancing technological advancement with environmental responsibility.

LED professional: As CEO, what strategies do you employ to steer BrightView towards continuous innovation and maintaining market leadership?

Jennifer Aspell: As CEO of BrightView, I drive continuous innovation through a culture that values creativity and cross-functional collaboration with a focus on working with customers to develop solutions for their most challenging problems. We invest significantly in research and development, anticipating customer needs and staying agile in response to

market trends. By recruiting top talent, fostering strategic partnerships and integrating emerging technologies, we ensure sustained growth. Our commitment to sustainability, market intelligence and measurable key performance indicators further solidifies our market leadership. We remain adaptable, encouraging calculated risk-taking and embracing a long-term vision for success.

LED professional: Looking towards the future, what significant opportunities for growth and innovation do you see, and what trends in lighting technology is BrightView preparing to meet?

Jennifer Aspell: We see a fundamental change in how photons are used across a range of applications from advanced displays to 3D image sensing. These market tailwinds are driving demand for optical technology based on MLAs. For example, in display, the need for advances in image quality and battery life demands require MLA solutions to meet more challenging performance requirements. One of the best ways to think about the next generation of displays is the evolution from SD to HD. When we only had SD, you didn't realize how poor the image quality was. Now that there is HD, none of us want to watch an SD channel. MLAs enable significant advances in image quality while not sacrificing brightness or color.



BrightView leverages its clean room facility to increase the development and manufacture of innovative optical films and components to meet demanding customer specifications.



Mini-LED display films are developed and tested to ensure alignment with application requirements.

AR/VR is another area where extending battery life is vital to market adoption. By improving brightness, BrightView's AR/VR MLA products provide a thin, lightweight mechanism to reduce energy consumption. We also see significant opportunities in automotive for BrightView's MLA technology. From creating brand identity through differentiated lighting to panoramic head up display or ADAS features based on LiDAR, MLAs are a foundational technology for all these applications. Specifically, within LED Lighting, our MLAs can provide functionality, energy efficiency and aesthetics as the world shifts toward sophisticated and visually appealing illumination in our everyday lives.

LED professional: What key lessons from BrightView's journey could be invaluable to the broader lighting industry?

Jennifer Aspell: First and foremost, the ability to be flexible and adaptable is essential to meeting both expected and unexpected challenges. Whether it was pivoting to face shields during the pandemic or moving into markets outside of lighting, BrightView's ability to use its capabilities to meet evolving customer needs has been the key to our success. Developing long term relationships with customers and providing industry-leading solutions rather than just engaging in transactions has helped BrightView remain at the forefront of the industry. We emphasize the importance of collaboration with the customer's design team, offering our expertise to customize optics that precisely meet their needs. At BrightView, we encourage industry professionals not to navigate the intricacies of design alone; instead, we empower professionals to leverage our collaboration to ensure designs reach the performance and visual standards a brand deserves. This collaborative approach not only enhances the efficiency of the design process but also ensures that the end result aligns seamlessly with the evolving requirements of the industry and customers.

LED professional: Thank you very much for sharing your insights with us. Your perspectives offer valuable understanding into BrightView Technologies and the lighting industry.

Jennifer Aspell: Thank you. ■

ABOUT Jennifer Aspell

Jennifer has held senior leadership roles in the optics industry for over 20 years, with a focus on commercializing high growth and emerging technologies. Beginning her career at Bell Laboratories, she developed technology for long-haul, optical networks and then moved into business and executive management roles at companies such as Lucent, JDS Uniphase, and Tyco Electronics. She is recognized as an effective and motivational leader with a consistent track record of commercializing new technologies. Jennifer has a Bachelor of Science degree in Electrical Engineering

from Rensselaer Polytechnic Institute, a Master of Science degree in Electrical Engineering from the University of California, Berkeley, and an MBA from Purdue University's Krannert School of Management. She holds several patents and is the author of numerous publications.

For additional information please visit www.brightviewtechnologies.com

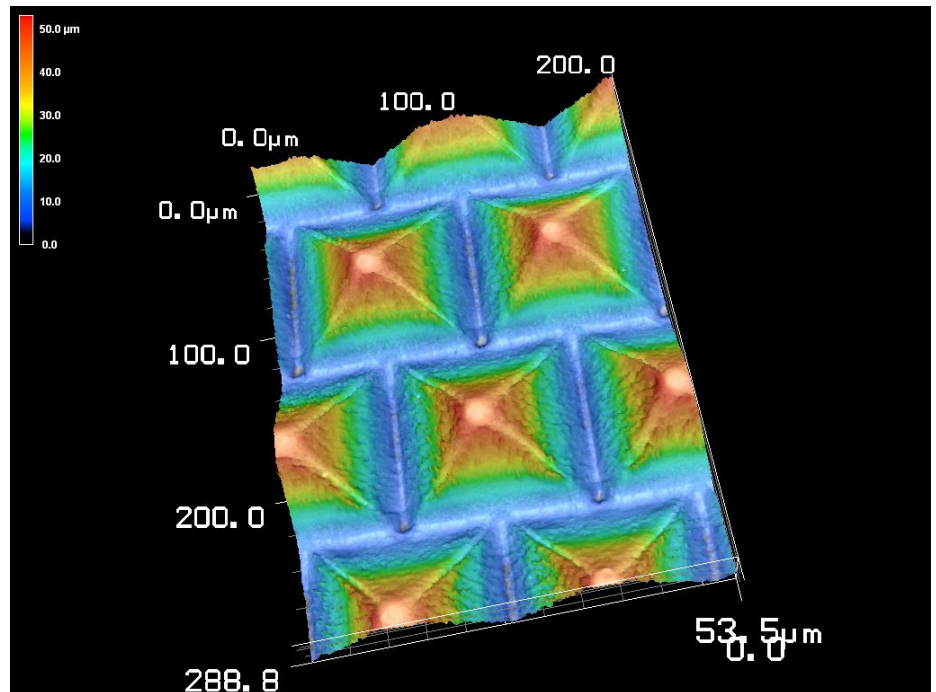

BrightView's MLA solutions consist of microscale lenses that are utilized to create precise lighting and control for a variety of applications.

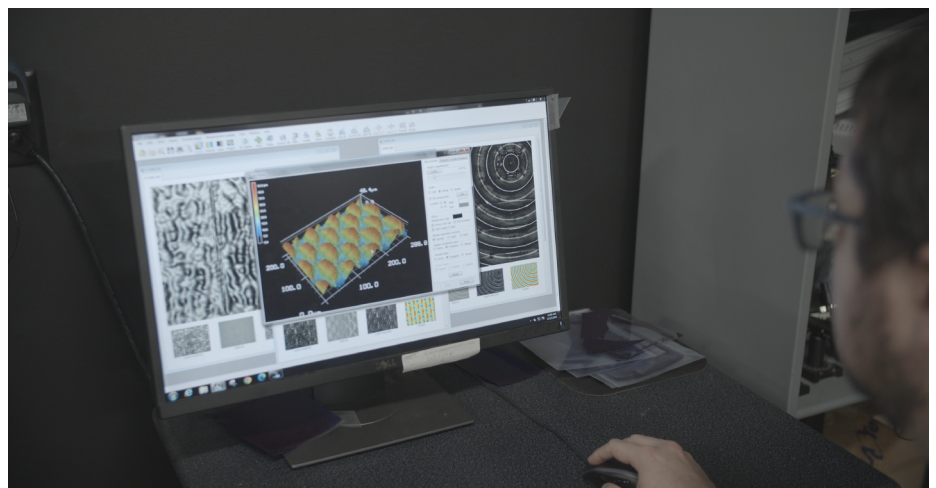

BrightView's optical engineers design MLA structures using a custom, in-house software.



Join the Lighting Design Community

www.trends.lighting

Subscribe to the monthly
Trends in Lighting Newsletter

Stay
up-to-date

LpS DIGITAL Summit and Awards: Exploring Cross-Disciplinary Lighting Innovations

Editors, LED professional

The theme of the LpS Digital 2023 held on December 7th was “Exploring Cross-Disciplinary Lighting Innovations.” This successful, annual online event, is organized by Luger Research e.U., publisher of LED professional.

A special thank you goes to the sponsors of LpS Digital, namely Samsung, Lumileds, DALI Alliance, Zhaga Consortium, LightingEurope, and Photonics Austria.

The recorded LpS Digital Summit can be viewed on the YouTube LpS-Digital channel and on LpS-Digital Online.

www.youtube.com/c/LpSDIGITAL



www.LpS-Digital.global



The event featured keynote speeches, a panel discussion, and the presentation of the LpS Digital Awards 2023.

Highlights included the following keynote presentations:

- **”From Regulations to Strategic Targets”**
Elena Scaroni, Secretary General at Lighting Europe, Belgium
- **”Building Light Environment Monitoring and Adaptive System to Ensure Health Effects from Lighting”**
Lawrence Lin, Founder of Lighting Recipe Studio and former CEO of LEDVANCE, Taiwan
- **”Lighting Trends for the Dynamic Automotive Market”**
Dirk Vanderhaeghen, Senior Director OEM Market Strategy at Lumileds, Germany
- **”Bridging Technologies in General Lighting and Automotive Lighting”**
Xavier Denis, Head of Technical Support and Marketing at Nichia, Germany
- **”Signify’s L-Prize Winning Luminaire and System”**
Grigory Onushkin, Lead Development Engineer LED and Scientist Solid State Light Sources at Signify Research, Eindhoven, The Netherlands. First oral sharing of the L-Prize winning luminaire and system!
- **”Micro-Optics and the PHABULOuS Pilot Line”**
Roman Trattnig, Deputy Head of Light and Optical Technologies at Joanneum Research, Austria

”It’s been a remarkable revelation how cross-disciplinary approaches can ignite incredible potential, unveiling new horizons and birthing groundbreaking ideas. We’re excited to be bringing you an array of insightful articles and significant findings that further explore this vibrant theme in

the coming months. Our deepest gratitude goes out to everyone for their inspiring contributions and dynamic engagement in this journey. Stay tuned for what promises to be an enlightening exploration!”

– Siegfried Luger, Organizer

Experts’ Interview on Trend Views

LED professional: From your perspective, what is the most important trend that will play a significant role in the further development of the lighting sector?

Elena Scaroni: It seems that sustainability is a game changer for many industries and now clearly for the lighting industry as well. This is an industry that is taking sustainability as a new opportunity, already going ahead requirements that will be imposed by law, e.g. on recycled content, on LCA and EPDs, on reparability of luminaires and on light at night. We now see increased customer demand for sustainable products, and we see our manufacturers are more and more keen on experimenting with remanufacturing and other business models related to sustainability.

Lawrence Lin: I believe smart will be the most important trend. But there’s so many gaps we need to work together to close in the infrastructure of smart lighting including devices, contents and platform. To engineer a disciplined and exchangeable system is how giant lighting players must move together to avoid chaos and add the value from lighting.

Dirk Vanderhaeghen: Adaptive lighting solutions which are able to change the shape of the light source (light emitting area), digitally (software) and in real time so that the light distribution can be changed

LpS DIGITAL CONFERENCE



LpS Digital Summit 2023

Exploring Cross-Disciplinary Lighting Innovation
Keynotes, Panel Discussion, and Award Ceremony

L231207-CONF

LpS Digital Summit 2023 has been recorded and can be viewed on the YouTube LpS Digital channel or on www.LpS-Digital.com. Image: (Top left to bottom right) Grigory Onushkin, Siegfried Luger, Elena Scaroni, Xavier Denis, Dirk Vanderhaeghen, Lawrence Lin, and Roman Trattnig.

accordingly. The benefits are: avoidance of glare, lighting trespass, and avoidance of overlighting. Such adaptive lighting solutions offer a more customized user experience which is situational adaptable, interactive and connected.

Grigory Onushkin: Lighting remains an essential contribution to our lives at work, at home and outdoors. LEDification of lighting will continue further to propagate in our life environment with optimized illumination solutions by aiming to give the right light, in the right place and at the right time. Anticipated benefits from optimized lighting can be numerous, covering a wide range from individual's comfort to environmental sustainability. The landscape of illumination applications is very broad with a wide range of diversity in requirements that will require different optimized solutions. A common trend will be to satisfy key and essential needs for each lighting segment by efficient and sustainable lighting systems.

Roman TRATTNIG: From the perspective of research and PHABULOuS as a Pilot Line project, that focuses on the development and optimization of free form micro-optical components, a significant trend in the lighting market is the increasing integration and advancement of LED technology, particularly in the realm of smart and connected lighting systems. LED technology has already revolution-

ized the lighting industry with its energy efficiency, longevity, and compact size. However, the next wave of innovation is definitely driven by the integration of smart features into LED lighting systems. As was also discussed, this includes the incorporation of sensors, connectivity (such as IoT capabilities), and AI-driven controls that enable adaptive and responsive lighting environments. These smart systems can optimize energy use, adjust lighting based on natural light availability or occupancy, and offer customizable user experiences.

LED professional: What unique insight did you gain from the presentations at the LpS Digital Summit that inspired you with new ideas?

Elena Scaroni: That the reduction of the environmental footprint is becoming a key objective when designing new lighting products. Products should not only be efficient, high quality and contribute to the well-being of people; they should be able to demonstrate that they have the least impact on the environment. I find this amazing!

Dirk Vanderhaeghen: Changes in the lighting ecosystem happen rather slowly and the regulatory framework becomes increasingly complex. It is important to de-complex and define attractive and enable industry standards and regulation that can

be deployed and harmonized widely. With the increasing maturity of technology and market LEDification, focus shifts more from electrical energy system efficiency to entire product lifecycle sustainability aspects (circular, emissions, (re-)use of materials, recycling, environmental light pollution).

Grigory Onushkin: It was surprising to see that many of the lighting products on the European market do not satisfy recent energy labeling and eco-design regulation requirements. It could mean that the lighting industry should continue to innovate further to support essential environmental and sustainability goals of our society. We all experience that lighting has strong emotional aspects and it was interesting to learn that there are ongoing studies to identify such connections and relations in detail. Automotive lighting applications continue to adopt more and more advanced features to improve safety and comfort of driving.

Roman TRATTNIG: I wouldn't call it a unique insight. However, the current drive for innovation in the automotive sector and the bridging to the area of general lighting is extremely interesting. The interlocking of the different areas of the lighting industry, especially with computer and AI-supported systems, is more than present and will play a decisive role in the very near future.

LED professional: From your presentation, what are the three lessons learned that you would like to share with our readers here in writing?

Elena Scaroni: * Companies need to prepare for the upcoming sustainability requirements by knowing what's required, by planning and educating their suppliers and building the evidence for any voluntary environmental claim on their products; in this respect, PSR 0014 is the right tool to fairly assess the environmental footprint of luminaires.

* LightingEurope and its national associations are there to help companies anticipate and address all sustainability challenges and to fight for harmonization of regulations in the different European countries.

* With its new strategy, LightingEurope is also there to educate the whole market to ensure that lighting comes first in all new and renovation projects and that the value of lighting is recognized along the value chain.

Lawrence Lin: Together with solid-state lighting and latest finding from research on photo-biological effect, lots of opportunities to increase the influence of lights. But the global lighting association like CIE, IES, Lighting Europe, GLA, CALI haven't coordinated to build the infrastructure and it is potentially dangerous. AI+IoT will reshape lighting technologies and the ways people use light; it would be great opportunity for the industry. Sick buildings with bad lighting systems that are not bright enough in the daytime and not dark enough at night are damaging people's circadian rhythm. People are without a clear understanding and we need to educate the market aggressively.

Dirk Vanderhaeghen: Cross application learnings from Automotive to General Illumination: Adaptive digital beam steering functionality. The contrast is so big between the feature rich lighting in higher end vehicles and the notion in illumination that consumers have only limited motivation for a premium on high quality lighting features. Automotive designers have embraced LEDs to create unique and differentiated styling (optical appearance and luminaire design). That is something we see (much less /rarely) in illumination. Modular design approach for mainstream cross platform adoption. LED modules which are not just replacement lamps ('retrofits') but a new standard, simplifying and standardizing fixture design and relevant for re-useability and sustainability.

Grigory Onushkin: Innovation competitions, such as 2009th Bright Tomorrow L-Prize bulb or the more recent L-Prize for commercial lighting, set demanding challenges that are addressing current and future illumination application needs and stimulate the shaping of future innovation trends and directions. The L-Prize winning Generation Flex prototype luminaire from Signify gives light without compromise as best-in-class, modular luminaire with high level of flexibility, optimized towards efficiency, quality of light and sustainability. This prototype luminaire, once coupled to Interact Next Gen L-Prize winning prototype connected system, will extend the use beyond just only giving right light towards satisfying essential needs of various groups of customers such as room occupants, building owners, installers and even energy providers.

Roman TRATTNIG: With respect to the advancements in LED technology PHABULOuS' focus on free form micro-optical

components is particularly relevant. Advanced optical designs can significantly enhance the performance and capabilities of LEDs, making them more efficient, directing light more precisely, and enabling new functionalities. For instance, micro-optical components can be used to develop LEDs that offer improved color rendering, brightness control, and beam shaping, which are critical for both aesthetic and functional aspects of lighting.

A crucial lesson learned in PHABULOuS is how interdisciplinary collaboration, involving fields like optics, metrology, materials science, and manufacturing, can lead to groundbreaking innovations. Navigating the challenges and opportunities presented by a diverse technological and scientific landscape, including all stages of the value chain, can provide valuable insights into effective innovation in high-tech environments.

Additionally, even though not directly a focus of the project but an experience made during its course: the trend towards sustainable and environmentally friendly lighting solutions gets more and more attention. Innovations in free-form micro-optical components can contribute to developing lighting solutions that are not only more energy-efficient but also more recyclable and aligned with the principles of a circular economy.

LED professional: In your opinion, does it make sense to look beyond the obvious and connect different applications of the lighting sector?

Dirk Vanderhaeghen: Looking beyond the obvious and making new connections across different application fields is key to drive new application innovations and future value creation! One obvious existing proof point, for example, is bringing more



LpS Digital Panel Discussion. Image: (Top left to bottom right) Roman Trattnig, Siegfried Luger, Xavier Denis, Grigory Onushkin, Dirk Vanderhaeghen, and Elena Scaroni.

colored light (entertainment, stage, studio) into architectural lighting and general illumination. Another opportunity triggered during presentations is applying general illumination features into the future of autonomous vehicles' interior lighting; or vice versa, applying some automotive lighting concepts to general illumination. Ample opportunities are available, considering the above mentioned leading trends.

Grigory Onushkin: We should continue to look for leveraging across lighting application segments. However, on-going targeted optimizations and innovations for diverse lighting applications often result in dedicated tailored solutions, which become more and more difficult to re-use and adapt for adjacent applications. For example, automotive dynamic pixelated head lighting systems are aimed at the precise control of a dynamic tight focused light beam, while only a few very special illumination applications might benefit from such fast and dynamic functionalities of high-brightness light beams.

Roman TRATTNIG: Absolutely, without any doubt. Connecting different applications within the lighting sector can lead to enhanced interoperability and smarter, more cohesive lighting systems. Such integration allows for the optimization of energy use, improved user experiences through customized and adaptive lighting solutions, and facilitates innovative applications like responsive urban lighting and IoT-enabled environments. This connectivity also paves the way for data-driven insights into usage patterns, aiding in energy conservation and efficient lighting management.

LED professional: Name one positive aspect for 2024 that your organization will bring as a new impulse to the lighting industry?

Elena Scaroni: LightingEurope will lay the foundations of the next EU Ecodesign lighting regulation and of the next energy labelling regulation, opening the discussion with policymakers and then with all stakeholders.

Lawrence Lin: Lighting Recipe Studio continues to innovate the biological lighting effects and enable customers and lighting manufacturers to embed with the evidence-based science and improve the quality and strength of lights. We expect to have 30 partners across the world in 2024.

Dirk Vanderhaeghen: Reduction of light pollution across applications is a new topic for our industry and Lumileds will continue to innovate in this area.

Grigory Onushkin: As one of first new impulses sparked by L-Prize and brought to the lighting industry in 2024, I would like to mention the recently announced introduction of the Ledalite BloomBox indoor LED luminaire: "that optimizes efficiency and quality of light, and supports circularity".

* Ledalite BloomBox troffer brings L-Prize-winning luminaire prototype concepts to market

* Lighting solution supports all project stakeholders, from specifiers and building owners to electrical contractors and occupants

* Design specifications available for office, higher education, healthcare and other commercial projects

Roman TRATTNIG: Joanneum Research will, of course, continue its work on (free-form) micro optical solutions. The resulting components will bring a significant positive impulse to the lighting industry by enabling the creation of more efficient, precise, and adaptable lighting systems. Innovations in optics could lead to lighting solutions that offer superior performance in terms of brightness, color rendering, and energy efficiency. Additionally, advanced results are expected to facilitate the integration of smart lighting technologies, enhancing the capability of lighting systems to be more responsive and customizable to user needs, and contributing to the broader trend of smart, sustainable, and user-centric lighting solutions.

LED professional: Is there anything else you would like to share with the participants?

Elena Scaroni: 2024 will be a particularly exciting year for LightingEurope members as we will be:

* Organizing our first CEOs' event to receive guidance from the leaders of our small, medium and big companies

* Launching meetings with our peers in Brussels and in the lighting market to discuss how to better enforce regulations and ensure that the value of lighting is clearly recognized, and

* Starting discussions with a new European Parliament and a new Commission to discuss what future European regulations should apply to lighting, from requirements on 'light at night', on hazardous substances and lighting product specific regulations.

Dirk Vanderhaeghen: Lumileds is optimistic about the short- and long-term future. While we may think of the LED market as being mature, we see many opportunities to give better solutions to end users!

About the Experts

Elena Scaroni is an accomplished professional with an extensive background in international affairs, policy development, and sustainability. With more than 7 years of dedicated service at LightingEurope, she currently holds the position of Secretary General since July 2023. In her role, she manages institutional relations with the European Commission, European Parliament, and EU Council, overseeing LightingEurope Working Groups and Task Forces related to Energy and Environment. Elena specializes in EU policy areas such as eco-design regulations, energy labeling, sustainable products initiatives, and circular economy action plans. Elena holds a Master's Degree in Law with a focus on International Law from the University of Rome "La Sapienza" and has completed specialized courses in European law and international politics. With her wealth of experience, Elena Scaroni continues to make significant contributions to the fields of lighting and sustainable energy.

Lawrence Lin is a distinguished figure in the LED and lighting industry, boasting 25 years of remarkable experience. He is celebrated for his profound expertise and extraordinary contributions to the field. As the Founder of Lighting Recipe Studio Co., Ltd, Lawrence remains at the forefront of innovation, continually shaping the industry's future. In addition to his role as CEO of Lawrence Co., Ltd, Lawrence also serves as the company's Head of Consulting. His focus lies in steering industry turnarounds, facilitating transformations, and driving development initiatives. Previously, Lawrence held the prestigious position of CEO of LEDVANCE GmbH, a major player in the global lighting sector. His strategic prowess and visionary leadership were instrumental in the successful acquisition of LEDVANCE GmbH, formerly SYLVANIA general lighting in the USC, and OSRAM general lighting globally. Throughout his illustrious career, Lawrence has demonstrated a deep understanding of LED packaging, lamp and luminaire production, supply chain management, innovation strategy, cross-border mergers and acquisitions, corporate management, turnaround expertise, and transformation know-how. His vast network spans influential figures in China and across the globe. Lawrence Lin's linguistic talents encompass English, Chinese, and Taiwanese, enriching his global impact on the industry. Armed with a Bachelor's degree in Chinese Literature from National Cheng-Chi University and extensive training in various facets of lighting technology, Lawrence Lin re-

mains a driving force behind innovation and excellence in the LED and lighting sector.

Dirk Vanderhaeghen, Senior Director of Lumileds OEM Market Strategy. Graduated in 1992 with a Masters electronic engineering degree from the University in Ghent, Belgium. He joined Philips Lighting in 1995 and worked for different application areas in special lighting and digital projection lighting. In 2005 he joined Philips Automotive Lighting Aachen, Germany. From 2009-2013 he worked at Lumileds in San Jose, CA and in mid-2013 he transitioned back to Germany, where he is currently responsible for the market strategy of the OEM automotive business.

Xavier Denis, Head of Technical Support and Marketing at Nichia. Xavier has 20+ years of experience in lighting and optical industries. He held various positions in research, design, production and application engineering. He is currently covering lighting technologies for Automotive and General Lighting. Xavier graduated from Georgia Institute of Technology in Applied Physics and holds an EMBA from Corvinus University of Budapest.

Grigory Onushkin is an LED Expert and Scientist in Solid State Light Sources at

Signify Research, based in Eindhoven, The Netherlands. His expertise centers around the exploration, pre-development and design of LED-based illumination systems, with a particular focus on the solid-state light generation for various lighting applications. Grigory's work includes advanced analysis, performance modelling and road mapping of LED technologies, as well as the meticulous design, measurement, and failure analysis of LED chips and packages. He has strong and diverse experience in various analytical methods for wide-bandgap semiconductors material research, design and analysis of high-power LEDs and packages. Notably, Grigory has been instrumental in designing and developing integrated Alternating Current operated LEDs (ACOLED or ACLED). His comprehensive skill set and innovative approach make him a leading figure in the field of LED technology and solid state lighting research. Prior to joining Philips Lighting (currently Signify), Grigory worked as Senior Engineer with key focus on design, development and analysis of LEDs and LED materials in Corporal R&D at Samsung. Grigory's academic foundation was solidified at Saint Petersburg State Electrotechnical University "LETI", where he completed his Engineering degree in the Physics of Semiconductor Devices, followed by pioneering research activities on

III-Nitride semiconductors conducted at Ioffe Physico-Technical Institute of fundamental research.

Roman Trattng is a distinguished professional with extensive experience in the field of light and optical technologies, currently serving as the Deputy Head of Light and Optical Technologies at Joanneum Research – MATERIALS. His academic journey began with a Diploma in 2009 and a Doctorate in 2013, both in technical physics specializing in organic electronics and photovoltaics from TU Graz. His career in extramural research started in 2009, focusing on the development of OLEDs and organic solar cells at NTC Weiz Forschungsgesellschaft. In 2013, Dr. Trattng transitioned to the industry, taking on a role as a project leader in technical optics and medical technology at Wild GmbH. His leadership skills further flourished in 2016 when he became the Head of Optical Development at Wild GmbH and later at XAL GmbH. Since 2018, he has been leading the photovoltaics research area at Joanneum Research. Currently he is part of the PHABULOus Pilot Line that uses the technology of free-form micro-optics, and he supervises the pilot cases. His blend of academic excellence and practical industry experience makes him a valuable asset in his field.

LpS DIGITAL AWARDS 2023



LpS Digital Innovation Awards: Honoree, Product- and Sustainability Winners, and Artificial Intelligence (AI) Prize.

Awards

The prestigious LpS Digital Awards were presented at the LpS Digital Summit, celebrating outstanding achievements in the lighting sector. The awards included an Achievement Award for exceptional contributions by an individual, a Scientific Paper Award for the best scientific paper published in 2023 in LED professional Review, five Product Awards for outstanding innovations, and five Sustainability Awards for products of special significance in sustainability and eco-design. For the first time, the AI Prize was also awarded, evaluated by a trained AI lighting model in the areas of Market & Innovation, Technology, and Sustainability.

The 2023 LpS Digital Award winners are: Achievement Award to Professor Shuji Nakamura (UC Santa Barbara), Scientific Paper Award to Anne Berends (Seaborough), Product Awards in the Sensors category to NanoLambda (BILL CHOI), in the LEDs category to Yujileads (Grant Wu), in the LED Modules category to Nichia Europe GmbH (Ulf Meiners, Giovanni Vecchio), in the Luminaries category to Fenos (Kaveh Ahmadian), in the Controls category to KUMUX (Leticia Arranz Rodríguez), Sustainability Awards in the UV LEDs category to BOLB (Maria Topete), in the LEDs category to Lumileds (Noman Rangwala, Steve Landau, Willem Sillevs Smitt), in the Controls category to Inventronics (Ilaria Zaccariello), in the Lighting Modules category to Modular International (Tony Madonna, EP-IES, IDA), and in the Tools category to Temeloy (Tiphaine Treins). The AI Prize 2023, with a score of 9.1 out of 10, was awarded to Nichia Corporation.

Achievement Award: Professor Shuji Nakamura



The Jury recognizes the lifetime achievements of Prof. Nakamura, particularly his impactful contributions to the energy and lighting sectors, his dedication to global sustainability, and his support for ongoing research in laser/LED technology, along with his efforts towards fostering a cohesive global society.

Prof. Shuji Nakamura is a globally recognized pioneer in the field of semiconductor technology, best known for his invention of the blue LED. Born in Ehime, Japan, in 1954, Nakamura's groundbreaking work has revolutionized lighting technology, paving the way for energy-efficient and sustainable lighting solutions. His blue LEDs, combined with red and green counterparts, have transformed electronic displays, leading to the development of white LEDs and blue laser diodes, which underpin Blu-ray technology.

Nakamura's contributions have earned him numerous accolades, including the 2014 Nobel Prize in Physics. Beyond his technical achievements, he has been a staunch advocate for inventors' rights and has championed the cause of sustainable and efficient lighting. Currently, he serves as a professor at the University of California, Santa Barbara, continuing his research and inspiring the next generation of innovators.

www.materials.ucsb.edu



Scientific Paper Award: Dr. Anne Berends



Scientific Paper:
"Unlocking the Health Benefits of Near-Infrared Light: A Breakthrough Clinical Study"

The jury finds that the paper presents novel research on the benefits of near-infrared light in the LED sector, including its application in photobiomodulation and health improvements. The paper is well-written, logically organized, and includes a comprehensive literature review. It also presents a clinical study with clear methodology and results, demonstrating the positive effects of photobiomodulation on health and well-being.

The paper explores the feasibility of integrating specific LED devices into daily life, proposing a USB-powered accessory design. Further research and development are needed for optimizing the performance, efficiency, and cost-effectiveness of photobiomodulation devices.

Best scientific paper published in LED professional Review (LpR) in 2023. Republished in LpR#100.

www.seaborough.com



Product Award: nanoLambda's BLE Spectroradiometer XL-500

Category Sensors



The jury recognizes the XL-500 by nanoLambda as an exceptional achievement in spectroradiometry, revolutionizing lighting research and industrial applications in plant, animal, and human-centric lighting fields. This tiny, yet powerful BLE spectroradiometer, paired with free Android and iOS apps, offers unparalleled convenience and precision. Weighing a mere 28g and measuring just 39x26x16 mm, the XL-500 is a marvel of engineering, combining a rechargeable battery and Bluetooth Low Energy technology for seamless operation.

Its ability to measure and record light spectrum with absolute power values, including SPD, PAR/PPFD, Lux, CCT, CRI, and CIE color values, sets a new standard in the field. This device's innovation lies in its compact size and affordability, bringing previously bulky and expensive spectrometer technology into a consumer-friendly realm. The XL-500's capability for continuous light spectrum measurement over weeks on a single battery charge is a testament to nanoLambda's commitment to advancing technology for practical, everyday use.

The jury applauds nanoLambda for creating a device that not only serves scientific and industrial needs but also has the potential to impact consumer applications, from health monitoring to pollution detection. The XL-500 represents a significant step forward in integrating advanced spectrometry into the Internet of Things, offering a new dimension of data collection and analysis in various fields.

nanolambda.myshopify.com

nanolambda

Product Award: Yujileads' CIE LED Technology

Category LEDs



The jury notes, that the lighting industry is witnessing a revolutionary innovation with the development of LEDs that precisely emulate the spectral characteristics of CIE illuminants, a significant departure from traditional lighting fidelity standards. Central to this advancement is the Spectral Accuracy Index (SAI), a purely mathematical tool surpassing conventional color accuracy metrics, enabling precise phosphor selection and production process fine-tuning.

This breakthrough, particularly relevant in architectural design, offers a familiar, comforting light akin to incandescent sources while leveraging LED efficiency and longevity. Additionally, it presents a sustainable, cost-effective alternative in sectors like photovoltaics, traditionally dependent on xenon lamps for critical spectroscopy. The versatility of these high spectral precision LEDs extends to enhancing art gallery and museum experiences, and improving healthcare settings, indicating limitless potential applications. This endeavor in LED technology, focusing on spectral replication accuracy, marks a transformative step in artificial illumination, poised to redefine industry standards and transform our interaction with artificial light.

www.yujilead.com

YUJILEADS

Product Award: Nichia's Light Cluster Type L

Category LED Modules

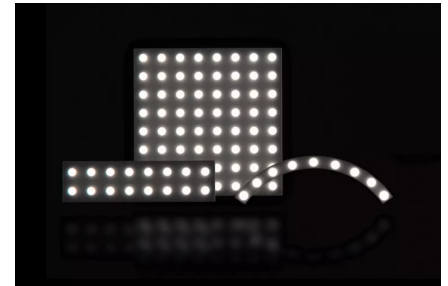

The Nichia Light Cluster™ Type L addresses a significant industry challenge of balancing uniform luminosity with lightweight profiles and reducing glare. Its ultra-wide light distribution ensures even illumination, creating a comfortable and glare-free lighting environment. It also reduces manufacturing and installation costs by allowing thinner, lighter fixtures. The product has a high market relevance, catering to a variety of applications, including architectural lighting and signage, and aligns with the market's push for environmentally responsible practices.

The Light Cluster™ Type L uses an advanced design to emit light not only directly above the module but also diagonally and sideways, introducing a new paradigm in lighting technology. It is versatile for various needs, showing high scalability.

The Light Cluster™ Type L reduces luminaire thickness by 60% and weight by 30%, therefore reducing the raw materials and energy involved in its production. It lowers transportation costs, mitigating carbon emissions. The energy efficiency of this LED technology also supports its sustainability.

www.nichia.co.jp/en

NICHIA

Product Award: Fenos' Track Light Kruza Maxi

Category Luminaries



The jury is profoundly impressed by the innovative Kruza Maxi track light, a game-changer in professional lighting for museums, retail, and art exhibitions. This cutting-edge lighting solution enables precise object-based light spectrum tuning through a user-friendly app, optimizing the appearance of objects according to specific design intents. Kruza Maxi's integration of a six-channel custom-developed LED module and a state-of-the-art color mixing optic ensures uniform intensity and exceptional color mixing, setting it apart in the realm of lighting technology.

The unique capability of Kruza Maxi to analyze scene pictures and optimize the spectrum based on object colors, enhancing chroma, and offering predefined scenes for familiar objects like fruits, is revolutionary. This feature, akin to 'Photoshop in the world of lighting', allows for unparalleled customization and visual enhancement in various settings. The light's flexibility, including manual and wireless control options, and its environmental benefits through reduced material waste and energy consumption, highlight Kruza Maxi's commitment to sustainability and efficiency. The jury applauds Kruza Maxi for its innovative approach, environmental consciousness, and its transformative impact on professional lighting.

fenos.be

Fenos[®]

Product Award: KUMUX's Dynamic Lighting API KUMUX

Category Controls

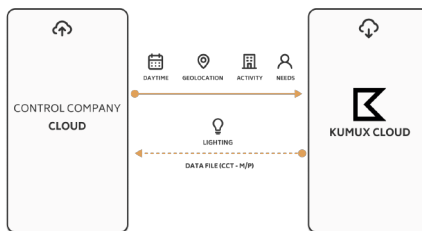

The jury commends KUMUX for its pioneering Dynamic Lighting API, a groundbreaking innovation in lighting technology that seamlessly integrates the properties of natural light into artificial environments. This innovation significantly enhances human well-being by replicating the solar cycle indoors, dynamically adjusting brightness and color temperature. The KUMUX API, rooted in cloud-based intelligence, artificial intelligence, and data science, marks a remarkable advancement in lighting solutions, transcending traditional static lighting.

KUMUX's approach, focusing on human-centric lighting, operates in harmony with natural circadian rhythms, fostering improved health, mood, and productivity. It is not only a triumph in technological and scientific prowess but also a testament to the company's commitment to environmental sustainability and energy efficiency. The flexibility and adaptability of the KUMUX API, compatible with various control systems, makes it a versatile solution in diverse architectural settings.

This innovation reflects a deep understanding of the vital role lighting plays in our lives, revolutionizing how light is utilized in indoor spaces. The KUMUX API is a significant contribution to the lighting industry, setting new standards for health, well-being, and sustainability. It exemplifies the successful fusion of technology with natural principles, leading the way in creating healthier, more productive environments through intelligent lighting design.

kumux.io

KUMUX

Sustainability Award: Bolb's UVB LED Technology

Category UV LEDs

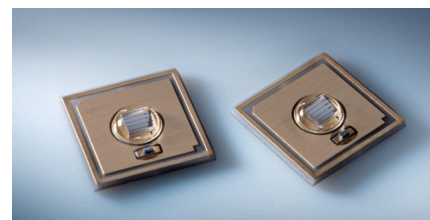

The jury recognizes Bolb, Inc.'s innovative UVB LED technology as a significant breakthrough in addressing the widespread issue of Vitamin D deficiency, often referred to as the "sunshine vitamin." This silent pandemic affects a staggering 42% of the U.S. population, with serious health implications. Bolb's high power, efficient UVB LEDs, particularly the 295 nm narrow band range, are perfectly aligned with the human skin's Vitamin D production spectrum, offering a more efficient and safer alternative to natural sunlight exposure.

The technological prowess of Bolb's UVB LEDs lies in their mass-produced, high Wall Plug Efficiency (WPE) of 10-15%, robust performance over 10,000 hours, and adaptability to industry-standard SMD packages. This innovation is not only a step forward in medical device development for health supplementation but also paves the way for new approaches to combat Vitamin D deficiency globally.

Bolb, Inc.'s commitment to creating solutions that address both health and environmental concerns is commendable. These UVB LEDs stand out as a crucial development in preventative healthcare, showcasing the potential to revolutionize how we address Vitamin D supplementation and overall human health. The jury applauds Bolb, Inc. for their significant contribution to the field of health and wellness through advanced lighting technology.

bolb.co

BOLB

Sustainability Award: Lumileds' NightScape LED Technology

Category LEDs

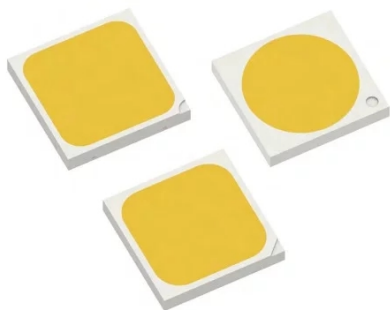

The jury applauds Lumileds' NightScape Technology as a groundbreaking advancement in outdoor lighting, addressing the critical issue of light pollution. NightScape LEDs, with less than 2% blue content, are a testament to Lumileds' commitment to sustainable and environmentally conscious lighting solutions. This technology not only meets, but exceeds the stringent requirements set by municipalities like Maui, Hawaii, in their efforts to protect the night sky and reduce the harmful effects of artificial lighting.

The superior efficacy of NightScape Technology, around 185lm/W, combined with its high reliability and excellent color rendering, makes it a standout choice in outdoor lighting. It successfully balances the need for low blue content with high-quality, broad-spectrum white light. NightScape's warm, amber-white light, reminiscent of traditional sodium lamps but with vastly improved performance, ensures user satisfaction in both color fidelity and visual acuity.

NightScape Technology is not just a solution for today but a forward-thinking innovation, ready to be integrated into existing and future outdoor lighting systems. This technology represents a significant stride towards a more sustainable and responsible approach to outdoor illumination, benefitting communities, wildlife, and the environment at large. The jury commends Lumileds for their pioneering work and their contribution to a brighter, yet environmentally friendly future.

lumileds.com



Sustainability Award: Inventronics' Bluetooth System HubSense

Category Controls

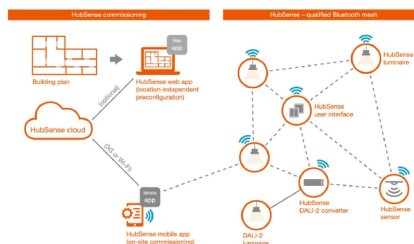

The jury recognizes HubSense® by Inventronics as a trailblazing innovation in wireless lighting control. This Bluetooth SIG-based system revolutionizes lighting projects, making them quick and effortless, especially in retrofitting scenarios. HubSense® eliminates the need for control cables and extensive masonry work, simplifying installation and maintenance. What sets HubSense® apart is its ability to form a reliable, responsive, and intelligent system for optimal lighting control. Its precise motion monitoring ensures that light is used only when and where necessary, contributing significantly to energy efficiency and reducing environmental impact. HubSense®'s standout feature is its simplicity and efficiency, distinguishing it from more complex systems in the market. The system's adaptability to different environments, including schools, offices, retail spaces, industrial projects, and parking areas, is remarkable. Its broad portfolio of sensors and integration capabilities for both standard and emergency luminaires, even with IP65 ratings, demonstrate its versatility.

HubSense®'s open, user-friendly web app allows for easy planning and commissioning of lighting projects. The system's flexibility in reconfiguration for new room utilization concepts, without interrupting daily activities adds to its appeal. Furthermore, sensor-based control systems support natural daylight, ensuring well-lit, comfortable, and sustainable interiors. In conclusion, HubSense® effectively addresses the challenges of modern lighting needs, striking a perfect balance between energy efficiency and user comfort. Its innovative approach to lighting control, with significant time and cost savings, makes it an exemplary solution in the lighting industry.

inventronics-light.com

inventronics

Sustainability Award: Modular International's LED Module 579e Series

Category Lighting Modules

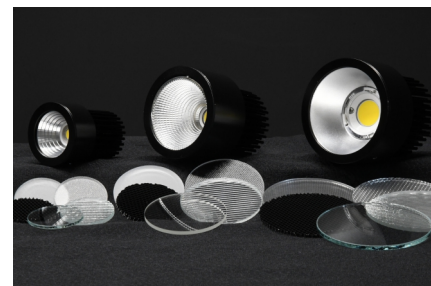

The jury proudly acknowledges the 579e LED module series by Modular International, Inc. as a groundbreaking advancement in lighting technology. This series represents a significant leap in energy efficiency (108-156lm/W), offering high output in a compact, cost-effective package. With industry-leading lumen per watt efficiency in various lumen packages and diameters, the 579e series sets a new benchmark in lighting design.

What sets the 579e modules apart is their ability to deliver high-quality color rendering (90+ CRI) with exceptional energy efficiency. The modules' advanced design, featuring a double gimbal ring assembly for adjustability and rotation, and a range of color temperatures (2,700-4,000K), makes them versatile for diverse applications. Modular International's commitment to innovation is evident in these modules' integration into an extensive range of product combinations, ensuring compatibility and adaptability in various settings.

The 579e series not only meets, but exceeds, industry standards in performance and sustainability, making it an ideal choice for both residential and commercial applications. Its recognition in the IES Progress Report as a significant advancement underscores its impact on the field of architectural lighting. The jury commends Modular International for their dedication to sustainable practices and for creating a product that contributes to energy efficiency and enhanced lighting quality in smart buildings.

www.modularinternational.com



Sustainability Award: Temeloy's Life Cycle Assessment Calculator LCA-CALC

Category Tools

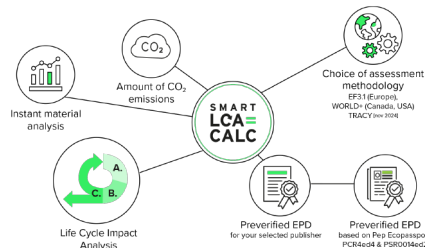

The jury celebrates Eco-Lighting Metrics' LCA-CALC as a transformative online platform, making a substantial contribution to sustainable lighting industry. This innovative tool empowers lighting specialists to calculate the environmental footprint of luminaires without the need for an LCA analyst, significantly advancing eco-conscious design practices in the lighting industry.

LCA-CALC stands out for its accessibility and affordability, breaking new ground in democratizing eco-design metrics and life cycle assessment. Its real-time, data-backed analysis provides clear insights into the ecological impact of lighting fixtures, from production to end-of-life. This user-friendly platform sidesteps greenwashing concerns, offering a reliable approach to assess and reduce the environmental impact of luminaires.

Partnering with CIRAIG, LCA-CALC leverages cutting-edge life cycle assessment research, making it the first tool in the lighting industry to offer such comprehensive and actionable environmental metrics. The jury applauds LCA-CALC for its role in promoting sustainable practices and for its pivotal contribution towards a greener future in lighting industry.

www.temeloy.com

TEMEL OY
ECO-LIGHTING INNOVATOR

AI Prize: Nichia's Light Cluster Type L

Best in Class Artificial Intelligence

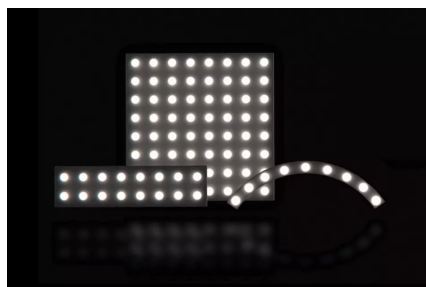

For the first time this year, the LpS Digital Awards were evaluated in parallel with an expert jury using artificial intelligence. A team of experts from the Technical University of Vienna led the development over several months. The basic AI-model was ChatGPT 4.0, developed by Open AI, which was then interconnected with an extensive database from the light, lighting and illumination sector. The resulting model was trained to evaluate submissions in the areas of Market & Innovation, Technology, and Sustainability. Ultimately, all submissions were scored by the model on a scale of 1-10 (with the maximum score being 10). The winner of the AI-Prize represents a substantial, sustainable, and significant innovation for an outstanding solution.

www.nichia.co.jp/en/



Summary

The LpS Digital Summit and Awards 2023, hosted by Luger Research e.U. and LED professional, certainly stands out as a significant event in the lighting industry. The theme "Exploring Cross-Disciplinary Lighting Innovations" highlights the importance of interdisciplinary approaches in the development of lighting technology. The presence of industry experts like Elena Scaroni, Lawrence Lin, and Dirk Vanderhaeghen underscores the summit's role as a hub for sharing cutting-edge ideas and insights.

The focus on topics such as adaptive lighting solutions, smart lighting trends, and the integration of LED technology across various sectors reflects the industry's commitment to innovation and adaptability. The success of the 2023 summit not only showcases the dynamic nature of the lighting community but also sets the stage for future advancements.

Looking ahead to the LpS Digital Summit in 2024, it's encouraging to see that the platform remains open for innovations throughout the year. This ongoing submission process suggests a continuous search for new ideas and solutions, ensuring that the upcoming event will be as engaging and informative as the previous one. The LpS Digital Innovation Awards, set to be presented at the 2024 summit, will likely spotlight the most groundbreaking and impactful advancements in the field, further driving progress in lighting technology. ■

For more information about LpS Digital Summit, Awards, and Expert Talks please visit:

www.LpS-Digital.global



LpS Digital is supported by Lumileds, Samsung, LightingEurope, Zhaga Consortium, and DALI Alliance.

Solid-State Lighting Report

Dr. J. Norman BARDSLEY, Founder and SSL Analyst, Bardsley Consulting

This summary of the latest ISA report on Solid-State Lighting (SSL) encompasses a comprehensive analysis of the SSL industry's progression, its impact on global energy use, and future outlooks. The report details the substantial strides made by SSL, emphasizing its potential in revolutionizing lighting while being energy-efficient.

Initially, the report highlights the importance of SSL in the context of global warming and energy conservation. It underscores light as a crucial necessity and the role of SSL in providing high-quality, affordable artificial lighting worldwide, which has significant implications for global energy consumption and environmental sustainability. The report stresses the industry's technical advances and its leadership role in sustainable resource utilization.

The history of artificial lighting, leading to SSL's introduction, sets the foundation for understanding the evolution and current state of the lighting industry. The report details the limitations of traditional lighting technologies and the potential of SSL to overcome these challenges, particularly in providing equitable access to quality lighting and minimizing the energy demand.

The core of the report delves into SSL's progress in efficacy, cost, and smart lighting, offering an extensive analysis of each aspect. In terms of efficacy, the development of LED chips and packages and their performance in various lighting products are examined. The report underscores the technological advancements and challenges in achieving higher efficiency and quality in LED lighting. In discussing costs, it presents a thorough examination of the decreasing cost trends of LED products, making them economically viable solutions. The section on smart lighting explores the advancements in connected lighting systems and the potential for further energy savings and operational benefits they bring to the table.

The report also critically examines SSL's impact on global energy use, noting that while there has been significant energy savings, the increased demand for artificial light globally has somewhat offset these savings. It provides an in-depth analysis of the situation in China and developing economies, highlighting the rapid growth of SSL adoption and its implications on energy consumption and lighting quality.

Looking to the future, the report calls for a renewed commitment to research and development to continue advancing SSL technology, emphasizing the need for further innovation in source efficacy, manufacturing techniques, and global access to SSL products. It suggests a multi-pronged approach to addressing the ongoing challenges and maximizing the potential benefits of SSL.

In summary, this SSL report offers a nuanced view of the SSL industry, celebrating its achievements while critically analyzing its challenges and future prospects. It serves as a call to action for continued innovation, collaboration, and commitment to making SSL a cornerstone of sustainable, equitable, and high-quality lighting worldwide.

Key Figures

The report delves deeply into the specifics of Solid-State Lighting (SSL) progression, its impact on energy, and technological advancements. Here are some of the most interesting results and figures:

- **SSL Efficiency Improvements:**
 - LED packages today provide white light at over 220 lm/W, a significant improvement from earlier lighting technologies. However, in most products, the efficacy of packages remains below this level due to various factors such as current density and heat management.
 - The best-in-class LEDs now achieve over 200 lm/W, but they are currently more expensive, indicating room for cost reduction as technology improves.
- **Global Energy Impact:**
 - The global annual production of artificial light is estimated to be 230 petalumen hours (Plmh), up from 135 Plmh in 2005, and is expected to rise to around 350 Plmh by 2040.
 - Despite the introduction of SSL, the global consumption of electricity for lighting has not significantly de-



Dr. J. Norman BARDSLEY, Founder and SSL Analyst, Bardsley Consulting

Dr. J. Norman Bardsley, a distinguished Professor of Physics, has earned international acclaim as an expert in solid-state lighting (SSL) through his advisory roles with the Department of Energy (DoE) and the International SSL Alliance (ISA). Renowned for his extensive and nuanced understanding of OLED technology, Dr. Bardsley possesses a comprehensive grasp of its manufacturing processes, cost structures, and ongoing research endeavors.

jnbard@pacbell.net

creased; it's estimated to be around 2900 terawatt hours (TWh), mainly due to the increased demand for artificial light, especially in developing countries.

- **Cost Reductions in LEDs:**
 - The cost of LEDs has dropped dramatically over time, making them economically viable. For instance, a mid-power 2835 package from a leading manufacturer might cost 0.43 cents (US) when bought in large quantities, a substantial decrease from earlier pricing.
 - LED streetlights, for instance, show a wide price range, indicating a diverse market. Lights from Bajaj, for example, produce 8400 lumens with an advertised lifetime of 50000 hours and are available for around US\$28, showing the affordability of high-quality lighting solutions.
- **Smart Lighting and Connected Controls:**
 - The report discusses the potential energy savings from Networked Lighting Control (NLC) Systems in the US, presenting findings in terms of a control factor (CF) which averages 49% in office and warehouse applications, indicating significant potential for energy savings.
 - Adoption of smart streetlights offers opportunities for further services using the same poles and communication networks. In Fuzhou city, a project involves 3304 poles to integrate various functions like public charging, light control, and other services.
- **Market and Technological Trends:**
 - There's an increasing shift towards LED as the dominant lighting technology globally, with about 50% of global residential lighting sales using LED technology.
 - The report highlights a shift in focus from pure efficacy towards other factors like price, light quality, and smart features in the LED and SSL market.
- **Challenges and Future Directions:**
 - The report calls for a renewed commitment to R&D in the SSL field, particularly to improve the efficacy of light sources and deliver light more efficiently.
 - It also emphasizes the need for improved manufacturing techniques, government and NGO efforts to facilitate global SSL product access, and more emphasis on testing product performance and lifetimes.

These details and figures illustrate the comprehensive scope of the ISA Quarterly report, highlighting the significant progress made in the SSL field, as well as the ongoing challenges and potential for future advancements.

Outlook

The ISA Quarterly report paints an optimistic yet realistic outlook for the future of solid-state lighting (SSL), emphasizing its pivotal role in creating a more energy-efficient, cost-effective, and sustainable global lighting ecosystem. As the demand for artificial light continues to grow, particularly in developing economies, the industry is expected to respond with significant advancements in technology and increased market adoption. The expected rise in global demand for artificial light to as much as 450 petalumen-hours by 2050 underscores the need for continued innovation in lighting technologies to meet these needs sustainably.

Technological advancements are at the heart of the SSL industry's future, with a strong focus on improving the efficacy of light sources and the quality of light produced. Achieving higher efficacy levels, potentially reaching 300 lm/W for white LEDs, will be a significant milestone, contributing to energy savings and operational efficiencies. Moreover, the integration of smart and connected lighting will usher in a new era of intelligent lighting solutions, enhancing control and paving the way for innovative applications.

The economic viability of SSL is set to improve as the cost of LED technology continues to decrease. This trend, along with the enforcement of minimum energy performance standards and the phase-out of less efficient lighting technologies, will drive broader adoption across various sectors and regions. Smart lighting and the Internet of Things (IoT) integration are also expected to play a crucial role in this transformation, enabling more sophisticated and energy-efficient lighting systems.

Sustainability remains a key driver in the SSL industry, with a focused effort on reducing energy consumption and mitigating the environmental impact of lighting. As the world grapples with the challenges of climate change, SSL stands as a critical solution in the shift towards a more sustainable energy landscape. The industry's commitment to innovation and sustainability will be instrumental in minimizing the ecological footprint of lighting.

The journey ahead for SSL will be shaped by robust research and development, underpinned by collaborative efforts across governments, industry, and academia. This collective endeavor is essential to overcome current challenges, enhance product performance and quality, and ensure equitable global adoption of SSL technologies.

In navigating these waters, the industry is set to have a lasting impact on the way we light our world, illuminating the path to a brighter, more sustainable future. As the industry continues to evolve, it promises not only to meet the increasing global demand for lighting but also to do so in a way that is both innovative and responsible, reflecting the changing priorities of a world in need of sustainable solutions.

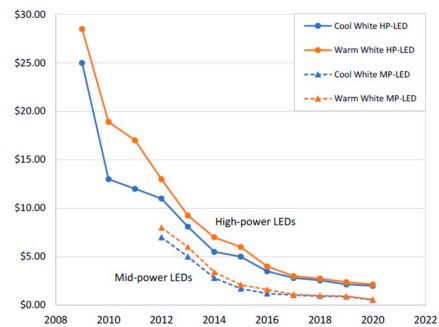

LED Package Price (\$/klm) over years. Source: US Department of Energy.

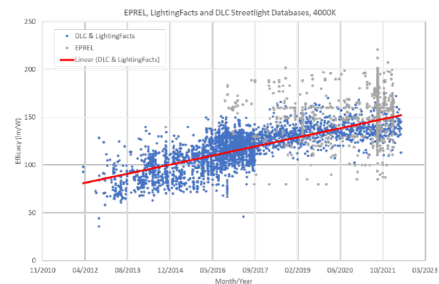

Efficacy values of outdoor luminaires from 2012 to 2022 out of EPREL, LightingFacts, and DLC Streetlight Databases, 4000K. Source: Michael Scholand LC, SSL Annex.

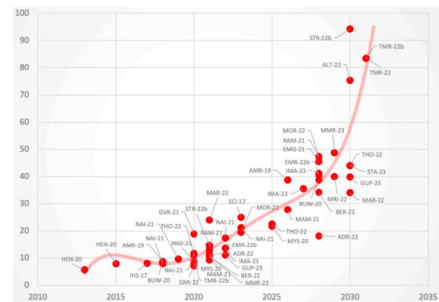

Forecasts of the market for smart lighting (Revenue in US\$ billion) by various analysts reviewed by Zissis and Bertoldi.

A more comprehensive report including more figures and graphs will be published in March/April 2024 issue of LED professional Review (LpR). ■

Redefining Glow: A Breakthrough Diffuser for Downlighting Excellence

Katharina KELLER, Director of Optics at Zumtobel Lighting

In this article, Katharina Keller, Director of Optics at Zumtobel Lighting GmbH, discusses the development of a special diffuser for the PHABULOuS LED Downlight Use Case.



Katharina KELLER

Katharina.Keller@zumbelgroup.com

Introduction

The last few years have seen a dramatic increase in the use of Free Form Microlens Arrays (FMLAs) for lighting applications ranging from automotive functional lighting to microstructured luxury facades. However, although industrial demand for FMLAs is a current market reality, the high access barriers to pre-commercial production capabilities in Europe prevent companies, from commercially exploiting FMLA technology.

PHABULOuS

As a way for reducing these access barriers, the EU funded PHABULOuS project was set up in 2020 to create a European pilot line for accelerating the manufacture of free-form micro-optics from prototypes to piloting and large volume production.

A key aim of the project was to implement six industrial use-cases that could demonstrate pilot manufacturing FMLAs in an operational environment, namely, AR, lenses for VR/AR headsets, automotive functional lighting, transportation lighting, luxury facades and for general illumination of a LED-Downlight.

LED-Downlight Use Case

Downlights are used in representative areas like lobbies and museums but also in functional areas like offices and corridors. In this use case the FMLA create a special diffuser. With FMLAs a great variety of intensity distributions can be realized, the elements itself are thin and light in weight. In this use case the manufacturing of free-form micro-optical components by UV replication technologies (Roll-to-Plate R2P) was tested.

This was to be achieved through the coordinated efforts of five partners: 1) Zumtobel Lighting GmbH (task leader), a leading supplier of integral lighting solutions for professional indoor lighting applications; 2) Power Photonic, a specialist in laser ablation processes; 3) Morphotonics, a supplier of R2P nanoimprint equipment, 4) JOANNEUM RESEARCH, an Austrian research institute with expertise in nanoimprint lithography; and 5) Centre Suisse d'Electronique et de Microtechnique, a Swiss research center active in the fields of precision manufacturing.

Objectives

The team's objective was to address the issue of inhomogeneous luminance, which derives from a multi-color light source. The problem is that in order to change the spectral content of the illumination, light sources must be tunable. However, to achieve tunability, white light sources usually consist of both, cool white and warm white LEDs, and it's this combination that creates the inhomogeneity.

As a solution, the team has developed a lighting unit containing a diffuser engineered from sheet-based products, which is able to homogenize the light and thereby meets the requirements of human centric lighting.

Design

The optical system was designed by Zumtobel Lighting GmbH and consists of a light source comprising cold white and warm white LEDs. The light passing through the diffuser is preformed by a lens. A simplified CAD model of the optical system is shown in **Figure 1**. The diffuser has a continuous shape as a base, and in order to create a hexagonal shape, the design was split and rotated.

Phabulous

<https://phabulous.eu/>

Diffuser Fabrication

The work stream for the fabrication of the diffuser consisted of the following steps:

Origination

The master was manufactured by Power Photonic via a laser ablation process that involved two stages: a cut stage to generate the gross form of the optic, and a smooth stage to reflow the top material to create a smooth surface. The aim was to produce a concave-convex lens array with the axis of the lens array rotated in 6 segments as shown in **Figure 2**.

Upscaling

Upscaling of the hexagonal pattern was performed by JOANNEUM RESEARCH via Step&Repeat (S+R) UV imprint lithography using Power Photonic's quartz master directly as the stamp. The aim was to achieve a seamless multiple replication of

the single master field on a flexible PET sheet sized 700x380 mm².

This S+R imprinting successfully delivered a fully patterned 200x200 mm² area without empty space or pattern-free lines between the imprints, as shown in **Figure 3**. After upscaling, the profiles showed a very conformal replication, with only low shrinkage in the range of 2-4%, which is normally expected due to UV crosslinking.

Roll-to-plate (R2P) Replication

After CSEM had galvanized the polymer shim to receive a durable nickel (Ni) tool, imprints from this Ni shim were realized using R2P technology at Morphotonics. A transparent flexible stamp was made from the shim using Morphotonics' in-house resin, and before imprinting, an in-house silane-based primer was used to ensure good adhesion of the imprint resin on the glass substrates.

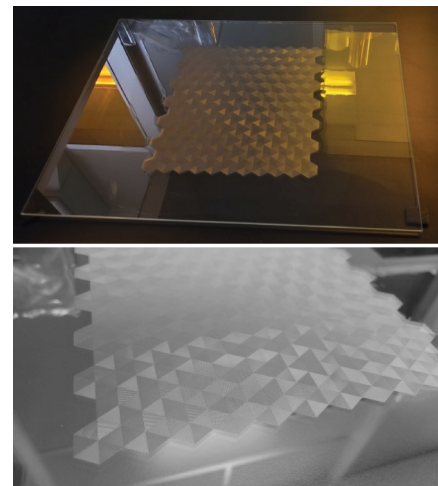

Figure 4: Camera pictures of the imprint on a glass substrate (460x350x3 mm³). Image Credit: Morphotonics.

The R2P replication process highlighted two issues. Firstly, due to the combination of the height of the texture and the resin used, a low pressure and a large gap (to reduce the pressure even more) were needed. But using those parameters led to layer thickness variations, which could create air pockets at the seams in a few places. Secondly, shrinkage was challenging as 5% of shrinkage was observed in the imprints in comparison to the nickel shim - an effect that could be improved by compensating the height in the original master and/or changing the imprint resin.

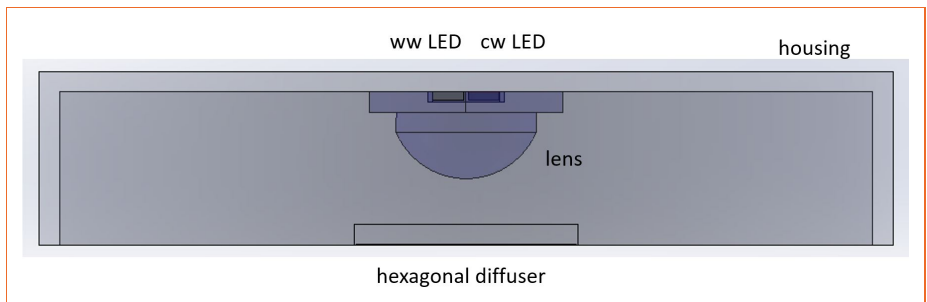

Figure 1: CAD model of optical system, simplified view. (ww=warm white, cw=cold white). Image credit: Zumtobel.

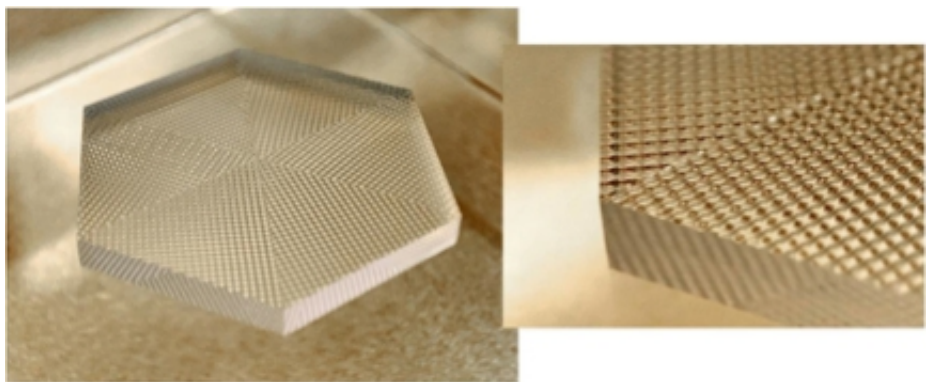

Figure 2: Quartz master fabricated by Power Photonic. Image credit: Joanneum Research.

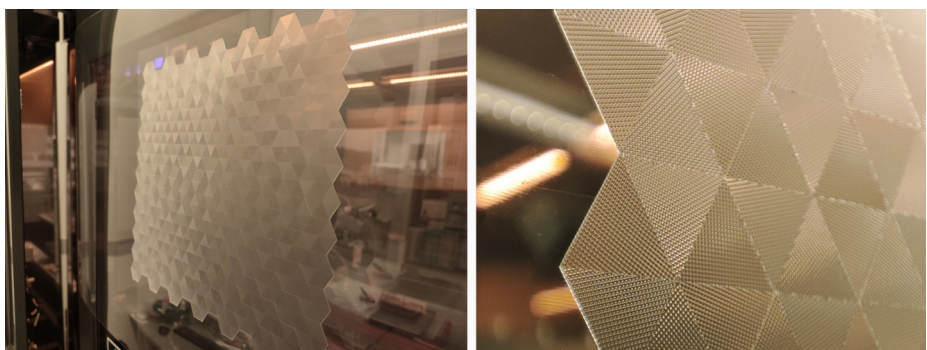

Figure 3: Finalized polymer shim. Image credit: Joanneum Research.

Conclusion

The collaboration for this use case delivered satisfying results. The S+R imprinting delivered a fully patterned 200x200 mm² area without empty space or pattern-free lines between the imprints, and after upscaling, the imprinted patterns showed a very conformal replication, with only low shrinkage in the range of 2-4%. The replicated diffuser produced a light distribution very close to our target distribution and fulfilled all requirements.

The project gave partners the opportunity to create a network where they could learn from each other, generate new ideas and explore new technologies outside conventional lighting.

The successful outcome was a diffuser for lighting applications in offices and public spaces like museums. But this is just the beginning, because the knowledge, experience and confidence we've gained from this project, has opened the door for us to explore and create more novel designs and components for a range of future lighting applications. ■

KUMUX. An Innovative Software Approach for Dynamic Lighting

KUMUX Advertorial | <https://kumux.io>

Recognition of the intrinsic benefits of natural light on the human body has achieved a high level of scientific acknowledgment. The positive impact of dynamic light on aspects such as circadian rhythm, sleep quality, and hormonal regulation has become an established science. Researchers have found a consensus in the idea that appropriate light exposure at specific times of the day not only enhances overall well-being but also plays a crucial role in optimizing physical and mental health. Under this premise, the concept of KUMUX began to take shape.

KUMUX stems from a passionate pursuit: a dedication to improving health through light. Founded by three enthusiastic light researchers from the University of Barcelona, Dr. Adrià Huguet Ferran, Dr. Blas Garrido Fernández, Dr. Sergi Hernández Márquez, alongside Beable Capital and the University of Barcelona, the genesis of KUMUX lies in their endeavor to transfer the beneficial properties of natural light to artificial sources.

Their journey commenced with the development of a Spectral Design Platform, a software tool designed to create high-quality lighting systems for healthcare. By combining LED lights, the founders aimed to replicate the characteristics of healthy natural light. The software simulates the mixture of LED spectrums to create luminaires that fulfill specific non-visual lighting characteristics.

As their vision evolved, they recognized the potential of introducing smart lighting setups to smart buildings, automatically simulating sunlight indoors throughout the day using a scientific approach. This realization led to the creation of the KUMUX API (Application Programming Interface), enabling the seamless integration of lighting data into smart lighting control systems, such as Casambi, Lutron, or Pharos.

With a team possessing diverse expertise in science, health, lighting, and smart control, KUMUX is united by a shared mission: leading a healthier light for all. The founders' commitment to improving well-being through innovative lighting solutions remains at the core of KUMUX's identity.

Overcoming Challenges in Lighting Design

KUMUX provides a comprehensive suite of software to assist lighting designers in the entire process, from conceptualizing dynamic lighting projects to implementation, thereby offering clients an effective dynamic lighting design.

In this context, the company has formulated guidelines elucidating how dynamic lighting positively influences individuals' wellness, productivity in workplaces, or reduction of falls in nursing homes. This marks the initial step for customers to comprehend and embrace this innovative lighting approach.

KUMUX also addresses the challenges encountered by lighting designers in both the design and implementation stages, equipping them with tools to streamline their tasks. Notably, the KUMUX API serves as the tool that facilitates an effective implementation of dynamic lighting. It is compatible with all types of luminaires and most control systems.

KUMUX API, The Right Light at The Right Time

At KUMUX, they work to transfer the unique properties of natural light to artificial light to improve people's well-being. Being firmly committed to bringing the benefits of the sun indoors and significantly improving people's health and quality of life. To achieve their objectives, they have a highly qualified team in lighting and innovation

dedicated to developing solutions that go beyond the visual component.

They have developed a software tool that introduces the concept of dynamic lighting through cloud-based artificial intelligence and data science. This allows natural changes in sunlight to be replicated in any indoor space by adjusting illuminance and color temperature, transforming static light into automated and dynamic human-centered lighting, running smoothly all year round.

To achieve this, the KUMUX API provides real-time data on the lighting settings adapted to the spectral characteristics of the luminaires, which serves as the basis for dynamic adjustments that align lighting with the natural progression of light throughout the day. This adaptability actively contributes to people's health and well-being by preventing disruptions to biological rhythms and the sleep-wake cycle, thereby improving mood and productivity.

The KUMUX API goes beyond individual well-being and addresses environmental and economic considerations. It facilitates significant savings by optimizing energy consumption through intelligent adjustments. Its ability to reduce electricity consumption during periods when our bodies need lower illuminance levels not only aligns with sustainability goals but also positions KUMUX API as an environmentally friendly and responsible lighting solution.

This KUMUX software is the result of technical and scientific support, guaranteeing a versatile and adaptable tool, compatible with various control systems and dimmable or temperature-adjustable luminaires.

The KUMUX API stands out as an innovation in lighting design. Its seamless integration with existing infrastructure allows users to overcome traditional limitations for the effective implementation of dynamic lighting projects, ushering in a new era of lighting automation.

Groundbreaking Solution for Human-centric Lighting

KUMUX, in its continuous search for solutions that redefine the understanding and experience of light, has identified challenges that affect various stakeholders in the lighting industry value chain. Currently, only 1% of indoor lighting focuses on people's needs and well-being, overlooking crucial aspects such as health, environmental protection, and overall experience.

Designers, engineers, and architects may have doubts about the effectiveness of implementing dynamic lighting solutions due to the inherent complexity and lack of understanding of the transformative potential of dynamic lighting by clients and users. In addition, implementing their visions and ensuring an improved experience within a growing market of control systems and a variety of lighting fixtures represents a significant challenge.

How does KUMUX solve this problem?

Thanks to its experience and knowledge in lighting, KUMUX focuses on the following properties:

- **Versatility and Adaptability:** Thanks to the architecture developed by KUMUX, based on the cloud and independent of the control system, it integrates perfectly into any smart system with the simple requirement of using adjustable or dimmable white luminaires.
- **Automation throughout the day:** Technology adjusts to needs as the day progresses. From dawn to dusk, the system provides the right light at the right time.
- **Science-based approach:** Addresses circadian lighting scientifically. The system uses data-backed insights to implement lighting that ensures well-being and improves health and productivity, leveraging spectral light data to adjust

control settings for optimal efficiency and comfort. The algorithm also considers the recommendations of the Lighting Research Center and WELL Building Standard to adjust the lighting settings for each type of space.

In this way, they take a holistic approach and are committed to addressing concerns, delivering results that ensure lighting designs create healthy, productive, safe, and attractive environments.

Lighting Innovation for Well-being

KUMUX technology brings a range of significant benefits, with key advantages including:

- **Optimizing well-being:** Dynamic lighting based on scientific principles, such as circadian lighting, contributes to the

Simulator

Configurator

My Projects

SIMULATOR

Solution
Office

Activity
Open area

Area (m2)
20.000

Height (m)
3

Location
United States

Daytime
January

[Download PDF](#)

Preview Powered by KUMUX



Circadian Lighting

KUMUX Lighting

Artificial Lighting

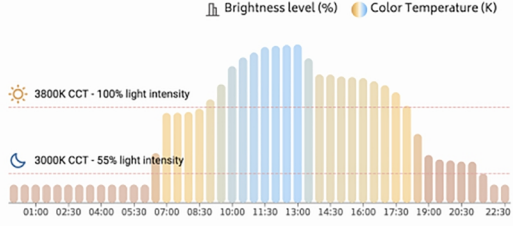

Geolocation

January

☀️ 07:20h 🌙 16:39h

Hours of light: 9



Savings

Number of employees: 12

Productivity

+4.5%

Absenteeism

-1%

Money saved

19.152 \$

*Values per year, average wage cost: 35.000

Power electricity price: \$ 0,256

CO₂ avoided

289 t

Energy saved

+ 21 %

Money saved

338.352 \$

*Values per year

The KUMUX simulator allows for the quantification of the benefits of human-centric lighting.

overall well-being of occupants by improving circadian rhythms and promoting a healthy environment.

- Improved user experience: By providing dynamic lighting that automatically adjusts throughout the day, KUMUX creates environments that enhance users' visual and emotional experience, contributing to greater comfort and satisfaction.
- Impact on productivity: Proper dynamic lighting has been shown to have a positive impact on productivity and cognitive performance. KUMUX contributes to the creation of environments that promote greater work and academic performance.
- Environmental sustainability: Energy efficiency and adaptability to daily and seasonal requirements not only generate economic savings but also position KUMUX as an environmentally friendly solution committed to sustainability.

These combined benefits position KUMUX technology at the forefront of innovation in lighting design, with a value proposition that expands to encompass a holistic approach. KUMUX is not simply a software package for dynamic lighting optimization, it is also a transformative solution that reshapes the lighting design landscape with an ongoing commitment to improving people's well-being and the sustainability of interior spaces.

In a world where the potential of dynamic lighting is yet to be fully realized, KUMUX remains committed to pushing the limits of lighting design, offering an innovative and adaptable solution that brings the benefits of natural sunlight, setting a new standard for smart lighting systems, and focusing on the human being. ■



KUMUX API lighting settings on a winter morning at BeAble Capital Offices.



KUMUX API lighting settings on a spring evening in a nursing home.

KUMUX

KUMUX is focused on transferring the properties of natural light into artificial light, to bring the benefits of sunlight indoors and enhance people's health and well-being. Their team has the light and innovation knowledge to create software that uses existing lighting and control systems in buildings to simulate daylight. KUMUX is sponsored by BeAble Capital, a technology-focused Venture Capital, which has supported this project from its origins at the University of Barcelona.

KUMUX Phone: +34 934 48 73 82

<https://kumux.io> | hello@kumux.io



The Global Information Hub for Lighting Technologies & Design

LED professional is the comprehensive publication and platform, connecting experts in the design, testing, production and commercial application of the latest lighting technologies & design information from around the world.



MORE THAN
45,000
READERS

GET YOUR
FREE E-MAGAZINE
SAMPLE



Illuminating Sustainability: Zumtobel's Pioneering Circular Economy Venture

Zumtobel Lighting

This article refers to a comprehensive analysis [1] of a pilot project for the reuse and high-value recycling of the TECTON continuous-row lighting system at EUROSPAR Lustenau. This project, spearheaded by Zumtobel Lighting in partnership with SPAR and carla Vorarlberg, a Caritas social enterprise, represents a significant advancement in the reuse and recycling of TECTON luminaires and trunking units.



Driving Forces and Trends

In March 2020, the European Commission adopted the new Circular Economy Action Plan (CEAP), which is considered one of the most important components of the European Green Deal. This new action plan announced initiatives for all stages of product life cycles. It sets out how products should be designed, promotes processes that are in line with the circular economy and aims to prevent waste so that used resources are able to remain within the EU economy for as long as possible. Based on this plan, various Austrian governmental departments began working on a national circular economy strategy, which was passed by the Council of Ministers on 7 December 2022.

The Austrian Recycled Building Material Ordinance aims to promote the circular economy and material efficiency by regulating both the recovery of building components and the production of high-quality recycled building materials from construction and demolition waste. It provides regulations for identifying polluting and contaminating substances as well as for removing, separating, treating and using recycled materials. When it comes to this ordinance, luminaire recycling is confronted with some significant challenges. Luminaires are usually collected in mixed groups. As it stands, luminaires are not reused and their component materials not sufficiently separated. Shredded material contains too many impurities such as copper and plastics. As a result of these factors, high-quality recycling for luminaires is difficult.

Luminaires fall under the Austrian Waste Electrical Equipment Ordinance. The infrastructure for recycling this equipment is based on a network of collection facilities, waste collection companies and recycling companies. The ordinance applies the EU Directive on Waste Electrical and Electronic Equipment (WEEE Directive 2012/19/EU) to national law.

Economic Factors

The following factors allow a sustainable, circular approach to be specifically applied as a means of achieving business-related or economic success (economic driving forces):

- **Resource scarcity:**
The scarcity of resources combined with volatile primary raw material prices (in this project, the copper used in TECTON) provide an incentive to rethink the way in which we use raw materials. This allows companies to reduce costs and limit their dependency on raw material suppliers.
- **Reduction in the amount of waste produced and associated costs:**
Reducing disposal costs. Components are not produced using new raw materials but rather reused, recycled and repaired. The result? Lower production costs and less waste.
- **Security of supply:**
The circular economy reduces reliance on supply chains. Building regional networks for reuse and repair offers additional security and resilience.
- **New business models:**
The transition from a linear to a circular business model opens up new sources of revenue. Examples of this include offering repair services, product remanufacturing and providing products as a service rather than an asset.
- **Job creation:**
New, environmentally focused job opportunities. The creation of jobs – particularly in disadvantaged regions – that aim to improve social integration and economic stability.
- **Profit and market share:**
Environmentally conscious consumers are specifically looking for sustainable products and services. A circular economy strategy will lead to increased demand and thus an improved market position for committed companies.
- **Innovation and competitive edge:**
Products are being rethought and re-



[z.lighting/en/zumtobel/](https://www.zumtobel.com/en)



TECTON trunking can be dismantled into individual sections. Its core components are steel (>70%), copper (>10%) and plastic (>10%).

designed so that they are easier to recycle or reuse. New technology grants companies a competitive edge and helps them tap into new market opportunities.

- **Image and brand promise:**
Adopting sustainable values aligned with the circular economy allows companies to establish a clear identity for themselves and distinguish themselves from the competition. This also increases awareness of the importance of circularity and enables companies to build a greater level of trust by means of transparency. By doing so, customers' own stance on sustainability will also be strengthened.
- **Legislation and incentives:**
Legislators are setting out tax incentives for recycled products and are implementing strict requirements for waste avoidance and disposal.

Project Description

The sustainability strategy of the Zumtobel Group is founded on three pillars: climate neutrality, the circular economy, and being the customer's partner of choice. This project is a practical implementation of these principles, aiming to explore the potential for circular value creation by establishing a network of partnerships. The central focus is on the TECTON continuous-row lighting system, a significant product within the Zumtobel portfolio due to its sophisticated modular construction and market success since its launch in 2001.

Key components of the project include

securing the disassembly process of old lighting installations, high-value recycling, and reusing the TECTON luminaires. The project revealed that a considerable portion of old lighting installations is usually disposed of and exchanged for more energy-efficient solutions, leading to a loss of valuable raw materials. Thus, the project sought to recover these materials for the production of the next generation of lighting solutions.



The EUROSPAR grocery store in Lustenau. TECTON luminaires and trunking units were carefully disassembled. These luminaires had been in operation for between four and eleven years at the time this project was launched.

Through this pilot project, 431 TECTON luminaires were securely disassembled and prepared for reuse. Additionally, 449 meters of TECTON trunking were sorted according to type and prepared for high-value recycling, resulting in the recovery

of 576 kg of steel, 72.4 kg of copper, and 91 kg of polypropylene. This innovative process aids in conserving resources and enables the reuse of valuable materials as part of a closed cycle.

The project also focused on establishing partnerships as a vital component of implementing circular economy principles in the lighting industry. Collaborations with various actors in the Vorarlberg region provided an exemplary model for global partnerships and best practices within the lighting industry.

In terms of process analysis, the project detailed the steps of disassembly, transport, and preparing the equipment for reuse or recycling. Specific challenges and potential improvements were identified, laying the groundwork for future endeavors in this field.

The results of the project were promising, showing a reduction in the expected luminous flux loss and significant CO₂ savings by reusing luminaires instead of producing new ones. This underlines the durability and excellent quality of the original LED technology used in the TECTON system.

In conclusion, the pilot project by Zumtobel Lighting and its partners has demonstrated the feasibility and benefits of applying circular economy principles to the lighting industry. It has set a precedent for future projects, aiming to optimize recovery processes, reduce waste, and contribute to a more sustainable and efficient use of resources.



Since the fall of 2023, the carla store in Bregenz has been illuminated with the luminaires that were originally installed at the EUROSPAR in Lustenau.



72.4 kg of copper recovered. 91 kg of polypropylene recovered. 576 kg of steel from the pilot project was collected alongside steel scrap of the same type from the Zumtobel factory in Dornbirn, checked for radioactivity and returned to the regional supplier's steelworks.

425 pc. **1.5 t** **330 t**

425 luminaires from the EUROSPAR store were re-used. The equivalent to around 1.5 tons of CO₂ was saved. Around 330 tons of CO₂ could be saved in production if the luminaires from the 220 EUROSPAR stores in Austria were re-used.

“It is wrong to focus on energy efficiency only during the utilization phase”.

PROFESSOR WERNER SOBEK, A PIONEER FOR SUSTAINABLE ARCHITECTURE

This statement reflects the broader ethos of the project — emphasizing the importance of considering sustainability throughout the entire lifecycle of products, not just during their use. It suggests a shift from a narrow focus on energy efficiency to a more holistic view of product design, manufacturing, and end-of-life management. This aligns with the circular economy approach the Zumtobel project aimed to exemplify and could serve as a powerful testament to the project’s underlying philosophy and goals.



After testing the luminaires a test report is issued and the luminaires labelled.

Results at a Glance

- **Successful Disassembly and Preparation for Reuse:** 431 TECTON luminaires were securely disassembled and prepared for reuse. 449 meters of TECTON trunking were disassembled, sorted, and prepared for high-value recycling.
- **Material Recovery:** 576 kg of steel, 72.4 kg of copper, and 91 kg of polypropylene were recovered from the disassembled trunking and prepared for high-value recycling. This innovative process aids in conserving resources and allows these valuable materials to be reused as part of a closed cycle.
- **Reduction in Luminous Flux Loss:** The project revealed that the reduction in luminous flux due to the ageing of the LEDs was not as severe as initially anticipated. This underlines the durability and excellent quality of the LED technology used in the TECTON system.
- **Significant CO₂ Savings:** Reusing old

luminaires instead of producing new ones resulted in the saving of more than 14 tons of CO₂. This demonstrates the environmental benefits of the circular economy approach in reducing the carbon footprint of lighting solutions.

- **Implementation of Circular Economy Principles:** The pilot project demonstrated the practical application of circular economy principles in the lighting industry. It involved a strategic approach towards repair, reuse, and high-value recycling of TECTON systems.
- **Establishment of Partnerships:** Collaborative partnerships were formed as an integral part of the project to implement circular economy principles in the lighting industry. These partnerships generated ecological value and regional jobs in social enterprises, which are core aspects of the pilot program.

The outcomes of this pilot project represent a significant step towards sustainable practices in the lighting industry. By focusing on repair, reuse, and high-value recycling, Zumtobel and its partners have demonstrated the feasibility and benefits of applying circular economy principles to reduce waste and make efficient use of resources in the lighting sector.

Project Partners

The project represents a collaborative effort among these companies and organizations, each contributing their expertise and resources towards the common goal of promoting the circular economy in the lighting industry.

- **Zumtobel Lighting:** A leading manufacturer of lighting solutions, Zumtobel spearheaded the pilot project. They aimed to develop luminaires in line with the principles of the circular economy and were pivotal in orchestrating the development of processes for reconditioning luminaires and recovering trunking material.
- **SPAR:** Specifically, SPAR Österreichische Warenhandels AG was mentioned as supporting the project. SPAR is a prominent retailer, and the implementation at the EUROSPAR store in Lustenau was crucial for the practical aspects of the pilot project.
- **carla Vorarlberg:** A Caritas social enterprise with many years of experience in reuse and repair across various product categories. For this project, carla Vorarlberg was involved in testing the functionality and safety of disassembled luminaires and contributing to the regional job market through its activities.

- **voestalpine Stahl GmbH:** This company is a steel supplier for the Zumtobel Group and was involved in the high-value recycling research project. The collaboration aimed to close the entire value chain for the high-quality recovery of steel.
- **G. Klampfer Elektroanlagen GmbH:** The team of electricians from this company was involved in the disassembly and removal process at EUROSPAR Lustenau.
- **Loacker Recycling GmbH:** Mentioned as part of the wonderful support for the project, Loacker Recycling GmbH contributed to the recycling and processing aspects of the luminaires and materials.
- **Consultants from EPEA Switzerland and the Design Studio EOOS:** Led by Harald Gründl, were involved in developing the Zumtobel Circular Design Rules (CDRs) alongside Zumtobel.

Summary

The Zumtobel Lighting pilot project on the TECTON continuous-row lighting system marked a significant step in sustainable lighting by successfully applying circular economy principles, leading to the effective disassembly and recovery of 431 luminaires and 449 meters of trunking, prepared for reuse and high-value recycling. This recovery process conserved substantial materials, including steel, copper, and polypropylene, while confirming the durability and quality of LED technology with minimal luminous flux reduction. Notably, the project resulted in more than 14 tons of CO₂ savings, underlining its positive environmental impact. The collaboration with partners like SPAR, carla Vorarlberg, and voestalpine Stahl GmbH was crucial to the project’s success, demonstrating the power of partnership in sustainable innovation. The methodologies and insights gained indicate promising scalability and potential for broader application in the lighting industry, positioning the project as a model for future circular economy initiatives. ■

References

- [1] White Paper. <https://sustainability.zumtobel.com/com-en/our-sustainability-dimensions/human-sustainability/pilot-project-eurospar>.



Measurement of the Luminous Flux More Accurate

Florian HOCKEL, Segment Leader LITE, Lamps and Multimedia Products at TÜV SÜD

LEDs are more energy-efficient and environmentally friendly than incandescent lamps. In 2009 the EU adopted a regulation that called for a gradual ban on conventional light bulbs. This has increasingly brought LED lighting products to the fore. However, their luminous flux decreases over time, which may lead to problems in many areas, including the medical sector and horticultural lighting. Manufacturers must therefore provide detailed information about the expected lifetime of their LEDs as well as the development of their luminous flux over time. A fully automated measurement method developed by TÜV SÜD delivers highly reliable data. Delivering measurements, on a 24/7 basis, the method saves resources while significantly improving the accuracy of light output predictions.

LEDs have almost completely replaced traditional lighting products – incandescent lamps – in many areas because of their technical properties and EU requirements. LEDs consume significantly less energy than incandescent lamps and exceed their service life many times over. However, a downside is that the luminous flux of these modern lighting products decreases over time. This can prove problematic in some areas, such as the medical sector or in horticultural lighting, where a specific light output is required for precise surgical interventions or to accelerate plant growth.

Long-term Testing Right from the Prototype Stage

In most cases, the drop in light output, also known as degradation of luminous flux, is gradual. Users might not even notice that, for example, a lamp in the operating theatre no longer provides the required light output. The manufacturers' information on light output therefore provides users with vital guidance on degradation over time so that they need not perform regular measurements themselves – for which most users would lack the required technical equipment anyway. Reliable and accurate information is the result of detailed measurements commissioned by the manufacturers of lighting products and performed by qualified testing, inspection and certification (TIC) organizations. Even before the start of series productions, the manufacturers deliver a few prototypes from a planned series to testing laboratories, where they are then subjected to comprehensive testing over a long period. The process is designed to provide a statement about the service life of the lighting product that is as accurate as possible.

In the past, such tests took nine and a half months, whereby the testing laboratories measured the luminous flux only at the start and the end of that period. In accordance with the new Ecodesign Regulation for Light Sources (EU) 2019/2020, this period has now been cut to only five months. However, the regulation requires that the

lighting products tested are exposed to continuous switching cycles consisting of 150 minutes of the light source switched on, followed by 30 minutes of the light source switched off. This means, testing involves a considerable workload that is hardly manageable manually. Given this, for some time, TÜV SÜD Product Service has been using the robogoniometer for testing lighting products. This robot uses a photo- and spectroradiometer that comply with the requirements defined by the German Accreditation Body (Deutsche Akkreditierungsstelle, DAkkS). The device automatically tests the light sources, adapting the measurement time to various lighting situations – similarly to the automatic adjustment of exposure time by a modern camera.

More Data, Reliable Results

The robogoniometer has halved the number of working hours required for these tests. In the past, testers had to remove and re-install the lamps themselves in every cycle. By contrast, TÜV SÜD's cutting edge robot now performs this task completely independently. Providing continuous 24/7 measurements, it delivers much larger volumes of data than previous measurement methods, and to a higher level of reliability. The device uses a measurement arm equipped with high-performance sensors, that it can move to various points of measurement to collect data. The measured values are saved in a database and processed in line with the terms of reference.

To ensure conditions are identical for every measurement, TÜV SÜD identified the variables relevant for the results in the test setting, evaluated their impact on the results and thus set out the basis for the comparability, evaluation and further processing of the data. Variables relevant to the test result include the type of fastening of the LED lamps, the presence of other light sources in the vicinity, the intervals between switching on and switching off the lamps and the temperatures in the test room.

Faster and More Reliable

TÜV SÜD's test setup, currently the only one of its kind, enables up to 8,000 light sources to be tested simultaneously in up to 300 projects in its Garching-based testing laboratory. The enormous advantage in terms of cost and speed is a quantum leap in the scalability of lighting product testing compared to conditions in even the recent past. Manufacturers obtain a far larger volume of data on their prototypes, and also gain direct access to the TIC organization's online database. They can thus access their test results at any time, enabling them to draw first conclusions before measurements have even been completed. This monitoring is unique compared to other automatic measurement methods, offering manufacturers the chance to integrate initial results into their product design and development from an early stage.

The robogoniometer makes predictions of the service life of LED lighting products more reliable. The modern test method is thus hoped to improve customer satisfaction, as it ensures delivery of the promised performance in most cases alongside compliance with the applicable legal requirements. ■



AUTHOR: Florian HOCKEL, Segment Leader LITE, Lamps and Multimedia Products at TÜV SÜD. Image credits: TÜV SÜD.



The robogoniometer at TÜV SÜD in Garching provides fully automatic 24/7 measurements of LED light output.



Expert Talks on Light – Micro-Optics in Automotive Lighting

HELLA-FORVIA | PHABELOuS Pilot Line

PHABULOuS

PHABULOuS is the one-stop-shop for free-form micro-optics, taking designs and prototypes to large-scale manufacturing. They have launched an open call to support the industry with the implementation and integration of free-form micro-optics, to bring your product to volume markets. This open call aims to support Europe's early adopters of our pilot line services to move towards volume production of free-form micro-optical components. Do you have a design and/or prototype and are looking to move your development into pilot or large-scale production?

The PHABULOuS value chain consists of Europe's leading Companies and Research & Technology Organizations allowing for seamless development from early phase proof-of-concept to regulated pilot production. Depending on the phase of the development and market application, a technical team and prime contractor are selected, who will help the companies to verify the technical requirements and support the company by making a design and/or prototype suited for large scale manufacturing.

Up to 3M€ of funding is available to support a minimum of 20 pilot cases / early adopters. They will be selected within the project to implement free-form micro-optical component and integrate that into their product developments with the aim to go towards large-scale production. The exact amount of subsidies per applicant will be decided based upon the type of company and the three main selection criteria. For each pilot case, also an in-kind contribution from applicant is expected.

For more information: phabulous.eu/open-call.

Content of the Talk

HELLA, operating under the overarching umbrella brand FORVIA, a leading automotive supplier worldwide, presents a use case in the PHABULOuS project. Free-form micro-lens arrays (FMLAs) offer aesthetics, potential for space and weight reduction, and low-cost manufacturing. HELLA's insights into automotive market requirements have led to significant steps in developing a free-form micro-optics-based solution. Watch the video of the use case here.

Micro-Optics Video



<https://bit.ly/3OeYQzx>

LpS Digital Expert Talks



<https://bit.ly/4bay5pN>

youtube.com/c/LpSDIGITAL

LpS Digital Sponsors



LpS DIGITAL



www.LpS-Digital.global

LpS DIGITAL CONFERENCE



PHABELOuS Pilot Case – HELLA
Micro-Optics in Automotive Lighting Applications

L240122 – Optics | SPONSORED

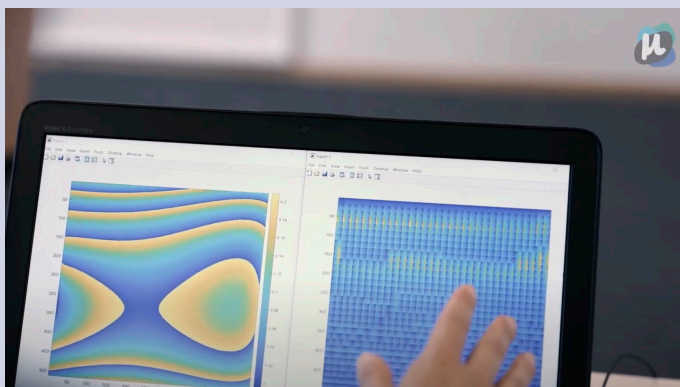

Expert Talks on Light

High-quality Content about Lighting Technologies, Design and Applications



Subscribe to the LpS Digital YouTube Channel



The first Life Cycle Assessment calculator for the lighting industry

LCA=CALC

SMART ECO-LIGHTING METRICS

Reducing costs and complexity on your path to sustainability



Receive **instant** material analysis



Create your:
Pre-verified EPD
for your selected publisher



Pre-verified EPD
based on **PEP Ecopassport**
PCR4ed4 & PSR0014ed2

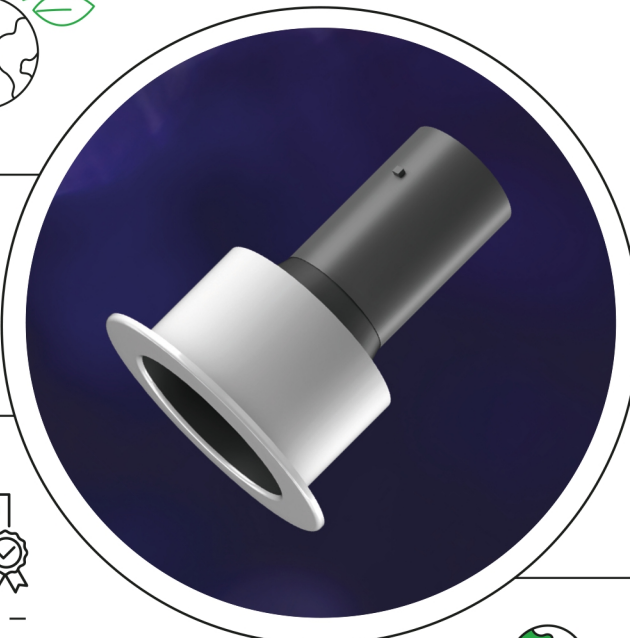

Assess life cycle impact analysis (**LCA**) of your luminaire



Calculate the **CO₂ emissions** of your luminaire



Choose your assessment methodology
EF3.1 / World+ / Tracy (01/2024)

Get started with LCA CALC

BOOK A DEMO



Visit us on www.lca-calc.com
Contact us via info@lca-calc.com



Good Light
For a healthier
and happier life

Want to know more of the well-being
benefits of Good Light?

www.GoodLightGroup.org



The **Good Light Group** is a non-profit organisation that promotes the health and well-being effects of Good Light. If you support our activities and want to join as participant, let's get in touch!

info@GoodLightGroup.org



DEADLINES | LpR 102

AD CLOSE
March 29, 2024

MATERIAL DUE
March 29, 2024

DIGITAL PUBLICATION
April 12, 2024

PRINT PUBLICATION
April 26, 2024

ENQUIRIES

editors@led-professional.com
info@lugerresearch.com

Subscribe



<https://www.led-professional.com/misc/subscribe>

Advertise



<https://www.led-professional.com/advertise>

PREVIEW*

Mar/Apr 2024 | LpR 102

Light + Building Report

In the forthcoming March/April 2024 edition of LpR, we are excited to offer a comprehensive exploration of the lighting industry. This issue will feature an in-depth **Light + Building post-show report**, detailing the foremost trends and breakthroughs showcased at the event in Frankfurt earlier in March. Additionally, we will publish an extensive **Solid-State Lighting Report**, offering a global perspective on energy and lighting metrics.

Our commitment to sustainability and innovation continues as we present an updated tool for **Life-Cycle Analysis**, a crucial component for designing eco-friendly LCA reports. A featured technical article will delve into the rapidly evolving realm of **cloud-based lighting controls**, a key trend in the connected lighting sector.

Furthermore, we are thrilled to provide an exclusive update on **Zumtobel's latest innovations**, as unveiled at Light + Building. Rounding off this issue, we will introduce an exciting **EU research project**, AI-Twin, showcasing the cutting-edge intersection of artificial intelligence and the lighting industry. Stay tuned for an issue brimming with insights and advancements that are shaping the future of lighting.

Questions and Comments

Please don't hesitate to send us your opinions or ask questions about articles you have read. We appreciate your feedback.
editors@led-professional.com

Annual Subscriptions

LpR Digital Magazine

- eMagazine (PDF download)
- 6 Issues per Year (Bi-monthly)
- Full Archive Access (all previous eMagazine issues)
- Business Issue to share and use within organizations
- EUR 78.80

LpR Printed & Digital Magazine

- Print Magazine including shipping
- eMagazine (PDF download)
- 6 Issues per Year (Bi-monthly)
- Full Archive Access (all previous eMagazine issues)
- Shipping costs included
- EUR 97.80

* *Subjects to change without notice.*
Cover Page Image: Humboldt Forum. Credits to Lichtvision Design.

Imprint

LED professional Review (LpR)
ISSN 1993-890X

Publishing Company

Luger Research e.U. | © 2001–2024
Institute for Innovation & Technology
Moosmahdstrasse 30, A-6850 Dornbirn, Austria, Europe
info@lugerresearch.com | www.lugerresearch.com
P +43 5572 394489 | F +43 5572 394489 90

Publisher

Siegfried Luger +43 699 1133 5570
s.luger@lugerresearch.com

Editors

Dr. Günther Sejkora +43 5572 394489 70
editors@led-professional.com

Theresa König +43 5572 394489 70
editors@led-professional.com

Elio A. Farina +43 5572 394489 70
editors@led-professional.com

Art & Design

Sarah Luger +43 680 2305 445
hallo@moments-of-aha.com

Account Manager

Christine Luger +43 699 1133 5520
c.luger@lugerresearch.com

China, Hong-Kong

Lolo Young +852 9792 2081
lolo@castintl.com

Germany

Armin Wezel +49 30526 891 92
armin@eurokom-media.de

India

Priyanka Rai +91 124 4787331
priyanka.rai@binarysemantics.com

South Korea

Jung-Won Suh +82 2 78 58222
sinsegi@sinsegimedia.info

Taiwan

Leon Chen +886 2 256 81 786-10
Jeon@jkmmedia.com.tw

Benelux, France, Ireland, Scandinavia, UK

Zena Coupé +44 1923 85 25 37
zena@expomedia.biz

USA & Canada

Lesley Harmoning +1 218 686 6438
lesley@lhmandco.com

Jill Thibert +1 218 280 2821
jill@lhmandco.com

Copyrights – Luger Research e.U.

The editors make every reasonable effort to verify the information published, but Luger Research e.U. assumes no responsibility for the validity of any manufacturers, non profit organizations or individuals claims or statements. Luger Research e.U. does not assume and hereby disclaims any liability to any person for any loss or damage caused by errors or omissions in the material contained herein, regardless of whether such errors result from negligence, accident or any other cause whatsoever. You may not copy, reproduce, republish, download, post, broadcast, transmit, make available to the public, or otherwise use LED professional Review (LpR) content without prior written consent from Luger Research e.U.

© 2001–2024 Luger Research e.U. – Institute for Innovation & Technology – VAT No. ATU50928705, EORI No. ATEOS1000046213, Commercial Register FN316464p, Regional Court Feldkirch, Austria, Europe ■



The Comprehensive Guide to the Lighting World

The Global Lighting
Directory 2024

Published by
LED professional &
Trends in Lighting

Showcase in LpR #102

March/April 2024



Submit Your Proposal to our Editors

editors@led-professional.com

www.led-professional.com