

LED professional

BY LUGER RESEARCH

Review

LpR 107

Jan/Feb 2025

LIGHTING INTERVIEWS WITH ARNULF RUPP & ALFONSO D'ANDRETTA

OPTIMIZING LIGHTING
ENERGY EFFICIENCY
PART II

EVOLUTION OF STREET
LIGHTS

The Global Information Hub
for Lighting Technologies
and Design

Post-Show
Reports
electronica

WÜRTH
AMS OSRAM



FusionBeam™
Technology

Bright Ideas. Bigger Impact. Setting the Standards for Video LEDs

Cree LED has long set the benchmark in video LED technology, transforming large-format displays, digital signage and video screens for events and commercial use. Now, we're raising the bar again with Resilient-Rated LEDs – engineered for unmatched durability and performance in the harshest environments, surpassing standard outdoor-rated products.

Our extensive portfolio and robust IP deliver exceptional color performance and reliability. With a fables manufacturing model, we ensure production flexibility and a stable supply chain to meet evolving demands.

Fueled by a legacy of innovation, Cree LED empowers customers to shine brighter and stay ahead of the competition.

Get details: cree-led.com/news/hb-innovation

Always Innovating. Always Leading.



Ultra Contrast
LEDs



Waterproof
LEDs



3-in-1
LEDs



Tilted Angle
LEDs



Follow us at:



©2025, Cree LED. All rights reserved.

LEARN MORE



lightfair
presented by **light+building**

May 4 – 8, 2025
Las Vegas, Nevada

Discover, Connect, and Learn at LightFair 2025

Join thousands of lighting professionals at LightFair 2025 to discover the latest technologies and trends. With over 100 CEU-eligible sessions, it's a great opportunity to sharpen your skills and connect with industry leaders shaping the future of lighting.



INTERNATIONAL ASSOCIATION
OF LIGHTING DESIGNERS

IALD

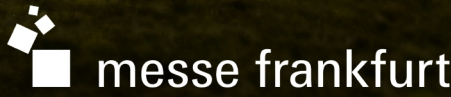

Insights and Breakthroughs from Leaders in Lighting Technology



First and foremost, I'd like to wish all our readers a happy, healthy, successful, and peaceful start to 2025. We hope your year has begun on a positive note!

The mission of LED professional Review (LpR) is to serve as a comprehensive, design- and technology-oriented information source. Our aim is to bring you the latest trends, innovations, and in-depth insights. By featuring contributions from top experts in the lighting industry, we provide perspectives that go beyond standard information, helping you stay at the forefront of lighting knowledge.

In this issue, we are excited to share insights from Elena Scaroni, Arnulf Rupp, and Alfonso D'Andretta, leaders at the cutting edge of lighting innovation. In addition, we went to Munich to visit electronica, the world's largest electronics fair, where we took a closer look at two of the leading exhibitors in the lighting sector: Würth and ams OSRAM.

The second part of Bartenbach's research study on optimizing lighting energy efficiency offers actionable solutions and data-driven findings from their comprehensive investigations. We also delve into advancements in outdoor luminaires and explore cutting-edge developments in automotive lighting module controls. Furthermore, we present two "Expert Talks on Light" from Lumileds, covering large-cluster multi-color LED solutions and car body lighting.

We are confident that you will find topics that spark your interest in this issue. As always, we welcome your feedback, ideas, and input.

Wishing you a wonderful New Year and an engaging read with the January/February 2025 issue of LpR.

Yours Sincerely,

A handwritten signature in blue ink, appearing to be 'S. Luger', written in a cursive style.

Siegfried Luger

Founder & CEO of Luger Research e.U.
Publisher of LED professional, Trends in Lighting, LpS Digital, and the Global Lighting Directory

WÜRTH ELEKTRONIK MORE THAN YOU EXPECT

PERFORMANCE.
RELIABILITY.
SERVICE.

Optocouplers by Würth Elektronik

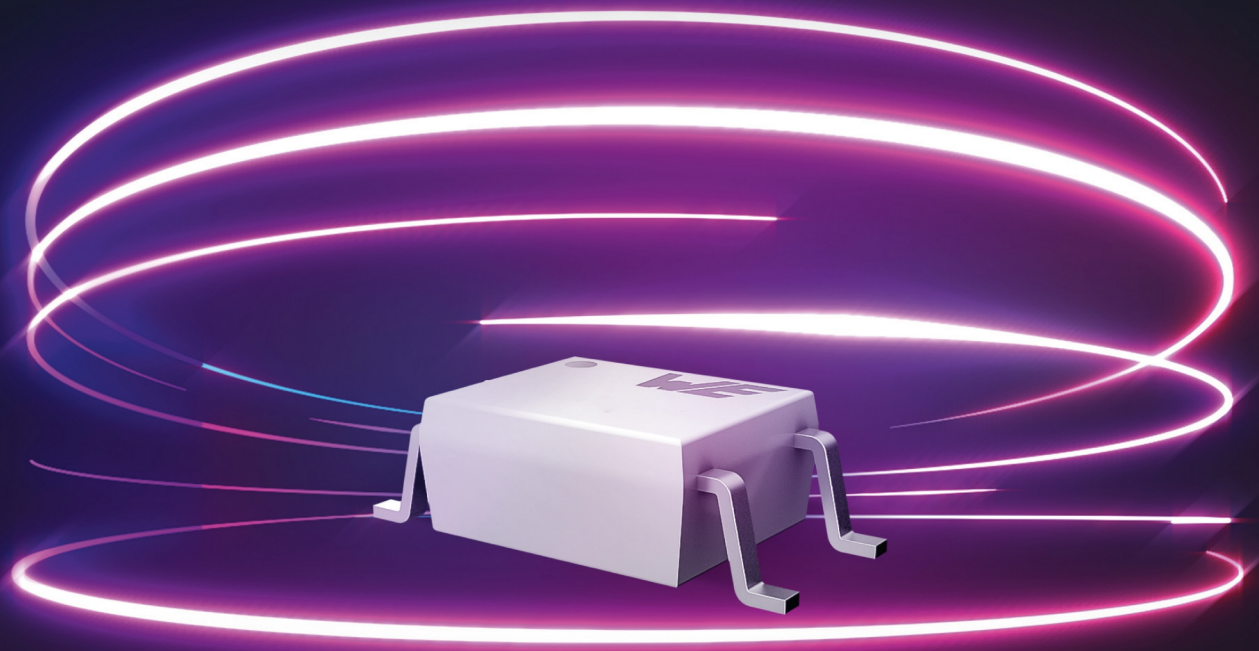

© eiPal



WE are here for you!

Join our free webinars on:
www.we-online.com/webinars

Optocouplers by Würth Elektronik

With the new optocouplers, Würth Elektronik presents one of the latest additions to its optoelectronic product portfolio. The innovative design features a coplanar structure and high-grade silicon for total internal reflection. The coplanar design ensures the isolation gap stay fixed during the production process and provide perfect isolation and protection for your application. The total internal reflection provide stable CTR over the whole temperature range and high CTR even at low current operation.

Provided in all industry standard packages. Available with all binnings ex stock. Samples free of charge: www.we-online.com/optocoupler

Highlights

- Innovative coplanar design
- High grade silicon encapsulation
- Copper leadframe for high reliability
- Stable CTR over whole temperature range
- High CTR in low current operation



DIP-4



SOP-4



LSOP-4

#OptocouplersbyWE

4 EDITORIAL

COMMENTARY

8 **Why Join LightingEurope in 2025?**
by Elena SCARONI, Secretary General,
LightingEurope



NEWS

10 **International Lighting News**



DALI LIGHTING INTERVIEW

20 **Arnulf RUPP, Governmental Affairs Director at Inventronics**
compiled by Editors, LED professional



GEWISS LIGHTING INTERVIEW

26 **Alfonso D'Andretta, Managing Director, BU Lighting at Gewiss**
compiled by Editors, LED professional



WÜRTH – POST SHOW REPORT

32 **Pioneering Progress: Würth Elektronik's Highlights and Innovations Unveiled at electronica**
by LED Professional Editors



AMS OSRAM – POST SHOW REPORT

36 **Lighting and Sensing the Future: ams OSRAM's Breakthroughs in LEDs, Sensors, and Projection**
by LED Professional Editors



LIGHTING RESEARCH

40 **Optimizing Lighting Energy Efficiency (Part II) – Consideration of Behavioral Aspects in Lighting Systems**
 by Dipl.-Ing. Johannes WENINGER, Dr. techn. Sascha HAMMES, M.Sc., Bartenbach

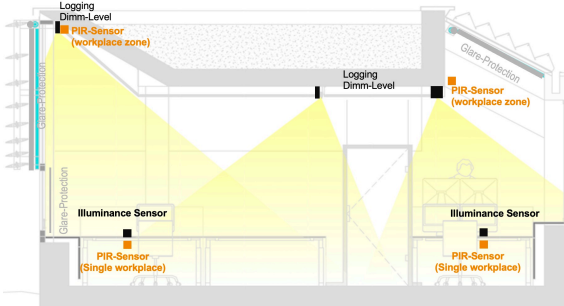

STREET LIGHTING

48 **Will Street Lights Become the Location of Choice for Sensors?**
 by Sara El Feky, Karl Göransson, Walter Longwe and Graham Mawer, Barcelona's Zigurat Institute

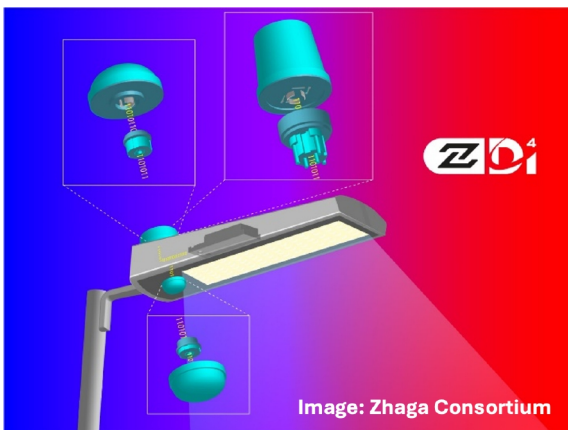

AUTOMOTIVE

50 **LED Matrix Manager Empowers High Density Automotive Intelligent and Safe Front Light System**
 by Jason BAI, Analog Devices

LPS DIGITAL TALKS

54 **Expert Talks on Light – LUMILEDS**

58 **ABOUT | IMPRINT**



ADVERTISING INDEX

2 Cree LED	13 Cree LED	57 Casambi
3 LightFair 2025	15 ams OSRAM	59 Global Lighting Directory
5 Würth	19 PHABULOUS	60 LED professional Review
9 LightingEurope	53 Bartenbach	
11 UL Solutions	56 DALI Alliance	



Elena SCARONI

Elena Scaroni is LightingEurope's Secretary General, appointed in June 2023.

Prior to this role, she served as policy director since joining LightingEurope in September 2016. Scaroni has been at the forefront of advocating the interests of the European lighting industry in the recent ecodesign and energy labelling regulations for light sources.

Prior to joining LightingEurope, she spent eight years in European affairs at Enel, a multinational energy company. Her responsibilities included managing relations with the European Parliament on all relevant issues such as climate, energy and corporate social responsibility.

She studied in Rome and Paris and holds a master's degree in law, specialising in European Affairs.

Why Join LightingEurope in 2025?

Why should your company invest time and resources in joining us in 2025? Because it can lead to good opportunities for growth for your business, and it helps you prepare for future regulatory trends in a timely fashion. We have an ambitious agenda for 2025.

See what's on offer for your business.

New financial opportunities from EU taxonomy thanks to LightingEurope

Did you know that the EU Taxonomy is an EU regulatory and classification system that defines environmentally sustainable economic activities? It aims to redirect capital flows towards sustainable investments by providing criteria for what constitutes a "green" activity. Luminaires are currently excluded. We ask for the inclusion of sustainable luminaires in 2025. Luminaire manufacturers in Europe may see their sustainability efforts rewarded by additional investment opportunities.

Fewer headaches on declaring the environmental footprint of lighting products

Providing comparable and verified sustainability information through Environmental Product Declarations (EPD) is a vital need for any industry. This is why our organization, in collaboration with the Global Lighting Association and the Green Light Alliance, is focusing its efforts on harmonizing product-specific rules on the environmental footprint of luminaires, LED modules and control gear. We are working to ensure that the rules developed by our experts are enshrined in EPD standards at IEC level and to provide training and guidance to members.

Fair rules in public procurement and incentives for lighting in the EU Clean Industrial Act

LightingEurope will also contribute to the EU Clean Industrial Act, ensuring that the sector's interests are represented. The aim of this EU initiative is to help the industry to decarbonize by proposing incentives, simplified procedures for

public procurement and simplified reporting obligations. We contribute to the debate with the support of the Coalition for Energy Savings, an alliance of industries and civil society organizations, advocating for effective EU legislation on energy efficiency.

Ecodesign and Energy Labelling regulations review: in the driving seat towards better rules

Both the Single Lighting Regulation and the Energy Labelling Regulation, pillars of the regulatory framework for lighting, will be reviewed by the EU Institutions, with new rules expected to come into force between mid-2027 and 2030. We will play a key role in defining these rules, as we are the most active and relevant stakeholder in the debate on these files.

Towards a simplified and harmonized regulatory framework at EU (and global) level for outdoor and indoor lighting on artificial light at night

We are promoting harmonized rules at European and global level, addressing growing concerns about light pollution and its effects, proposing clear solutions to policy makers and working with key civil society actors such as DarkSky.

Stay ahead and prepare for the future: Network with industry leaders and policy makers

Bringing together industry leaders and policymakers, the Third European Lighting Summit in Brussels on 27 March will give you valuable insight into key issues such as eco-design, the Clean Industrial Deal, cybersecurity, substances and light at night.

To keep the industry engaged and informed, every year LightingEurope organizes more than 20 webinars and trainings on key regulatory topics for members only.

LightingEurope's 2025 agenda and partnership demonstrate its commitment to driving sustainability and growth in an increasingly competitive global landscape. It's time to join us. ■

E.S.

EUROPEAN LIGHTING SUMMIT

27 March 2025
13:30 - 18:00 CET

FOLLOW US



JOIN US



The event will be followed by a cocktail
offered by LightingEurope.



LIGHTINGEUROPE
THE VOICE OF THE LIGHTING INDUSTRY

www.lightingeurope.org

Seats are limited

LightFair 2025: A New Era of Innovation, Education, and Networking for Lighting Professionals

www.lightfair.com

LightFair, the premier lighting trade show and conference, is set to revolutionize the industry once again in 2025. Taking place at the Las Vegas Convention Center, May 4 - 8, this must-attend event will showcase a dynamic blend of cutting-edge education, groundbreaking product showcases, and exceptional networking opportunities.



Bold Leadership for a Brighter Future

LightFair, North America's largest architectural and commercial lighting event, joined the Messe Frankfurt family with the expansion into the Light + Building brand. Moving forward, Messe Frankfurt will organize the five-day trade show and accompanying conference in partnership with the International Association of Lighting Designers (IALD) and the Illuminating Engineering Society (IES). Constantin von Vieregge, President and CEO of Messe Frankfurt Inc., emphasized the strategic importance of this collaboration: "This partnership combines Messe Frankfurt's proven expertise in organizing global trade events with the IES and IALD's deep connections to the lighting industry. Together, we aim to create an unparalleled platform for innovation, education, and industry advancement."

Endless Opportunities: Diverse Products and Services

LightFair 2025 promises to be the most impactful event yet, drawing industry leaders, from around the globe. The expansive trade show floor will feature hundreds of exhibitors, ranging from global brands to innovative startups. Visitors will have the chance to explore the latest in residential, commercial, and industrial lighting solutions, gaining access to the tools and technologies driving the industry forward.

Education That Shines: Earn CEUs

LightFair 2025's educational programming is second to none, offering attendees the chance to earn Continuing Education Units (CEUs) through a robust lineup of sessions - enhancing their expertise while fulfilling professional development requirements. The

comprehensive curriculum will cover topics ranging from emerging technologies and sustainable practices to design trends and business strategies. With world-renowned speakers and hands-on workshops, attendees will gain actionable insights to elevate their careers and businesses.

Celebrating the Future: Lighting Innovation Awards

Returning this edition, the Lighting Innovation Awards – a prestigious celebration of groundbreaking advancements and outstanding achievements within the lighting industry. Designed to honor companies who demonstrate exceptional creativity, ingenuity, and impact in lighting design and technology. From state-of-the-art smart solutions to transformative sustainable practices, the awards shine a spotlight on the innovations creating a brighter future for the industry.

Unveiling the Trend Area: Where Vision Meets Reality

Debuting this year is the Trend Area, a forward-looking space that offers a glimpse into the products and designs defining the path forward in lighting. This curated showcase will feature emerging innovations that blend functionality with artistry, pushing the boundaries of what's possible in the field.

Immersive Lighting Installations: Experience the Extraordinary

Be inspired by a series of immersive lighting installations that explore the interplay of light, space, and emotion. These installations will highlight the transformative potential of lighting in creating environments that are both functional and awe-inspiring. Attendees can step into a world of creativity and technology. These experiential displays will demonstrate fresh perspectives and inspiration for projects of all scales.

Unforgettable Networking Opportunities

Networking takes center stage at LightFair 2025. Highlights include the opening night reception, a celebration of the industry's achievements, and a variety of structured and informal networking events. Attendees will connect with peers, potential collaborators, and industry leaders in an atmosphere designed to foster meaningful relationships.

Join LightFair 2025 offering attendees the opportunity to explore trend-setting innovations, earn CEU credits through an informative education program, and experience hands-on product demonstrations. Featuring over 500 exhibiting companies, the event connects lighting designers, architects, engineers and specifiers with cutting-edge solutions and technologies across all product categories, including lighting controls, sustainable design, and human-centric lighting.

Company Description:

LightFair is the premier annual architectural and commercial lighting trade show and conference, connecting lighting designers, specifiers, architects, and engineers. Explore innovative products, cutting-edge education, and unparalleled networking opportunities. Join us May 4-8, 2025, in Las Vegas to discover the future of lighting. Learn more at <https://lightfair.link> ■

LightingEurope Publishes Guidance on the Use of Standards in Products

lightingeuropa.org

The document gives precious guidance and information to manufacturers on the use of standards (EN, harmonized EN, OJEU listed harmonized EN and non-EN standards) in Europe and in the United Kingdom when preparing the Declaration of Conformity. This document outlines all the different options available to manufacturers, leaving it up to them to choose which option to follow.



Brussels, 18 November 2024 – Version 1

Guidance and Information Paper on The Use of Lighting Product Standards in Europe

Scope

Why is a Guidance paper needed?

The harmonization process has become increasingly complex and has slowed down. Many standards are being published without listing in the OJEU (and also in UK designated standards lists). However, these not listed standards do not provide the formal legal presumption of conformity attributed to harmonized standards. Currently there is also significant misalignment between the 'overlap dates' detailed in the standards (DOP; DOW) and the corresponding listing/delisting dates used for the OJEU and UK designated listings. This causes confusion in the market for both manufacturers and customers who now have uncertainty as to which versions of standards they should follow, which should be used for third party certifications (e.g. ENEC, national approval marks), and which should be shown in the EU and UKCA declarations of the manufactures or importers.

Main focus of the paper

The paper mainly focuses on Directives using Module A (Internal production control) where the manufacturer can declare the compliance with the essential requirements by using harmonized standards or other publications following their own risk assessment (i.e., EMC, LVD, RED). ■

LightingEurope Promotes Smart Lighting via a New Video

lightingeurope.org

LightingEurope is excited to unveil a new video that highlights the benefits of smart lighting. This video explains how smart lighting enhances building performance and introduces key metrics for evaluating smart technologies.



The video showcases how smart lighting systems intelligently respond to occupant needs and environmental changes, optimizing energy efficiency and improving comfort. By adjusting light levels based on daylight and occupancy, these systems significantly reduce energy consumption while creating tailored lighting scenes that boost productivity and well-being.

Additionally, the video emphasizes the importance of assessing building smartness through rating schemes, including the forthcoming Smart Readiness Indicator (SRI), which will reward buildings with advanced lighting controls.

LightingEurope Secretary General Elena Scaroni stated, "Smart lighting promotes well-being and productivity in our environments. Our video demonstrates how adaptive lighting transforms spaces into comfortable and sustainable settings, making it accessible for everyone." ■

Alfonso D'Andretta Elected to LightingEurope Executive Board

www.gewiss.com

LightingEurope, the voice of the lighting industry in Europe, is pleased to announce the election of Alfonso D'Andretta to its Executive Board.

With over 16 years of business management experience in multinational companies, D'Andretta has been a driving force in the electrical, electronic, and mechatronic industries. His wide-ranging background



Solutions

Safety. Science. Transformation.™

Connect with our engineers for all your testing and certification needs.

Learn more at UL.com/lighting.

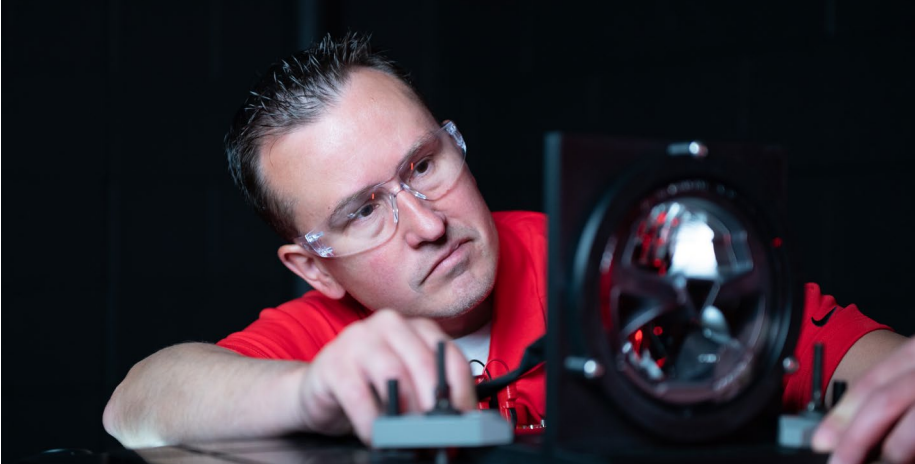

spans access control, building management, energy, IoT, safety, and security sectors.

D'Andretta's career highlights include several years at Philips Lighting (now Signify) in various roles and in the Middle East, where he directed the setup of MELA (Middle East Lighting Association) and Group Chief Sales Officer at Iseo Ultimate Access Technologies from 2020 to 2024.



He is currently Managing Director of the Business Unit Lighting at Gewiss, where he also serves as a member of the Group Executive Committee and the Board of Performance iN Lighting.

LightingEurope Secretary General Elena Scaroni stated, "I am very glad that Alfonso, with his company Gewiss, which only recently joined LightingEurope, is already ready to be part of the governing body of our association. I am sure that his experience, commitment

and enthusiasm will contribute to the forward thinking of our Board and to the strategic direction of LightingEurope and the lighting industry. We look forward to working with him."

About LightingEurope
LightingEurope is the voice of the lighting industry, based in Brussels and representing 32 companies and national associations. Together these members account for over 1,000 European companies, a majority of which are small or medium-sized. They represent a total European workforce of over 80,000 people and an annual turnover exceeding 15 billion euro. LightingEurope is committed to promoting efficient lighting that benefits human comfort, safety and well-being, and the environment.

LightingEurope advocates a positive business and regulatory environment to foster fair competition and growth for the European lighting industry. More information is available at www.lightingeurope.org.

About Gewiss
Development as a constant in management is the philosophy that has guided GEWISS's choices from its foundation to today. Established more than fifty years ago, GEWISS has made development and the research for quality the principles that have

guided every action and every choice. Guided by the values of integrity, excellence and sustainability, GEWISS offers innovative and scalable solutions for buildings, industries and infrastructures, capable of connecting people and things and improving safety and quality of life. The constant investments aimed at research and development, the training of all personnel and the strengthening of production facilities have allowed GEWISS to establish itself as a reference point for the market in the production of solutions and services for home & building automation, for the protection and energy distribution, for e-mobility and smart lighting.

The year 2023 marked a significant milestone in the Group's growth journey with the acquisition of PERFORMANCE IN LIGHTING, an historic leader in the lighting industry. The inclusion of the PERFORMANCE IN LIGHTING brand "powered by GEWISS" has allowed the entire Group to expand the range of services available to the market through platform synergies and organizations, offering even more integrated solutions and technologies. All the proposals are designed and produced to meet every lighting need, representing the perfect synthesis of aesthetic design and technical performance. The constant drive towards innovation, a hallmark of the entire Group's history, further positions lighting solutions as a solid global reference in the world of design and architecture. ■

Cree LED and Daktronics Enter Licensing Agreement for LED Display Technology

www.cree-led.com

Cree LED, a Penguin Solutions brand (Nasdaq: PENG), and Daktronics (Nasdaq: DAKT), announced a multi-year, global patent license agreement effective December 2024. With limited exceptions, this agreement provides a license to Daktronics for Cree LED's patented technology for the duration of the agreement.



With over 35 years of expertise in LED die and packaging technology, along with a robust portfolio of intellectual property covering their use in LED displays, Cree LED has consistently invested in innovation, securing numerous patents to protect its advancements. As a trusted industry leader,

Cree LED remains committed to delivering best-in-class, durable solutions that exceed the rigorous demands of next-generation LED-based displays.

Daktronics, as a leader in the large-scale LED display market, is committed to ensuring that their customers have access to state-of-the-art LED display systems. This agreement enables Daktronics to confidently provide industry leading LED display systems to the market, knowing that its products will not be subject to claims based on the licensed Cree LED patents.

Specific licensing terms remain confidential. This license agreement ensures there are no patent disputes between the parties based on the licensed Cree LED patents for the term of the agreement. Cree LED is a registered trademark of CreeLED, Inc. All other trademarks and registered trademarks are the properties of their respective owners.

About Cree LED

Cree LED, a Penguin Solutions brand, offers one of the industry's broadest portfolios of application-optimized LED chips and components, leading the industry in performance and reliability. With more than 35 years of innovation, our strong IP portfolio and unique business model ensures supply chain continuity. We deliver best-in-class technology and breakthrough solutions for focused applications in high power and mid-power general lighting, horticulture, specialty lighting and video screens. For more information, visit www.cree-led.com.

About Daktronics

Daktronics has strong leadership positions in, and is the world's largest supplier of, large-screen video displays, electronic scoreboards, LED text and graphics displays, and related control systems. The company excels in the control of display systems, including those that require integration of multiple complex displays showing real-time information, graphics, animation, and video. Daktronics designs, manufactures, markets and services display systems for customers around the world in four domestic business units: Live Events, Commercial, High School Park and Recreation, and Transportation, and one International business unit. For more information, visit the company's website at www.daktronics.com. ■

Agreement Signed for the Acquisition of the Beghelli Group

www.gewiss.com

As previously communicated to the market through a dedicated press release pursuant to Article 17 of Regulation (EU) 596/2014,

available on the Beghelli website and the "Info" regulated information dissemination system managed by Computershare S.p.A., Gewiss and Beghelli informed that on December 10, 2024, Gewiss S.p.A. entered into a preliminary sale and purchase agreement with the majority shareholders of Beghelli for the acquisition of a majority stake in Beghelli S.p.A.'s share capital.



The completion of the acquisition, which is subject to the occurrence of certain conditions specified in the press release, is expected to take place by the first quarter of 2025. Subsequently, Gewiss S.p.A. will be required to launch a mandatory public tender offer for the remaining outstanding shares of Beghelli, with the aim of delisting the company.

The project aims to:

Ensure continuity for Beghelli's employees, collaborators, and customers by integrating into a group with solid Italian roots, shared values of integrity, excellence, and sustainability, and a managerial governance model already focused on transparency and innovation;

Strengthen market presence: the integration of the highly recognized Beghelli brand in Italy with Gewiss' global expertise will allow the consolidation of market share in the lighting sector;

Expand the range of innovative solutions: combining Beghelli's technological expertise in emergency lighting with Gewiss' know-how in energy management and smart lighting will enable the development of integrated products and services to better meet the evolving needs of the market and our customers, who can rely on an even stronger team. ■

NULTY Acquires KLAASEN Lighting Design

www.nultylighting.co.uk

Nulty has announced the expansion of its reach across Europe and Asia, with a particular focus on Singapore, through the acquisition of KLAASEN Lighting Design—a brand with a 40-year legacy in the architectural lighting design industry.



A New Star is Born! XLamp® XN-P LEDs are an easy drop-in upgrade for superior performance

XLamp® XN-P Color LEDs revolutionize multi-color lighting with a flexible, high-power platform. XN-P Color LEDs enable easy design-in to existing 5.75 x 4.68 mm designs with the same footprint, LES and optical profile while optimizing lumen output, color temperature and rendering. Ideal for entertainment moving head, architectural spot and machine vision applications demanding maximum intensity.



www.cree-led.com

This acquisition strengthens the long-standing relationship between Nulty and KLAASEN, a globally respected firm known for its innovative approach to lighting design and commitment to collaborative client relationships.

Martin Klaasen, Founder of KLAASEN, will assume the role of Managing Partner at Nulty, bringing over 30 years of experience and significant influence within the industry. He will work alongside Paul Nulty and Mark Vowles to oversee projects across the Asia-Pacific region, ensuring continued delivery of creative excellence and exceptional client service.

In Europe, Jordan Faust will become Managing Partner of the newly established Lisbon studio, integrating KLAASEN's team into Nulty's European division. With expertise in lighting design and landscape architecture, Faust will collaborate closely with Ellie Coombs, Managing Partner of Nulty's London studio, to expand the firm's presence and drive new projects across Europe.



This acquisition marks an exciting step in Nulty's journey to broaden its global reach and enhance its creative capabilities.

"Today marks an exciting new chapter as we welcome KLAASEN into our Nulty family. As we look to consolidate our position as a market leading brand and build alliances in key markets, Martin and his team will fuel our growth plan and provide an injection of new talent and specialist expertise. We're delighted to have them on board to take Nulty to greater heights," said Paul Nulty. ■

Violumas Boosts 275nm and 265nm Output in Next Generation UVC LEDs

violumas.com

Violumas, provider of high-power UV LED solutions and inventor of 3-PAD LED technology, has launched new 275nm and 265nm LEDs in mid-power, high-power, and high-density packages.

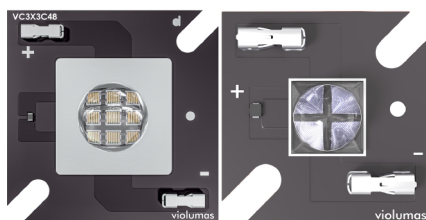

Violumas, provider of high-power UV LED solutions and inventor of 3-PAD LED technology, is proud to launch the release of new 275nm and 265nm LEDs in mid-power, high-power, and high-density packages.

The radiant flux of the new 275nm and 265nm LEDs increased by 35-50% from the previous generation, to achieve 130mW (275nm) and 110mW (265nm) in compact, single-LED packages of 5.2mm x 5.2mm. The improved radiant flux of the UVC LEDs is achieved by the incorporation of a transparent p-Contact layer and high reflectivity metallization in the epi-wafer.

The new 275nm and 265nm LEDs are also available in 4-LED, 9-LED, and 16-LED chip-on-board (COB) configurations and provide unrivaled levels of power for any UVC application. Violumas' high-density VC4X4 Series feature the most powerful single-emitter UVC LEDs on the market. With the development of higher power 265nm and 275nm LEDs, the VC4X4C48L9-275-V1 boasts an impressive 1650mW radiant flux while the VC4X4C48L9-265-V1 features 1400mW radiant flux.

Each LED is encapsulated with a single, high-transmission fused silica lens that allows for long-term, stable performance over time. A selection of 30°, 60°, 90°, 120°, and 135° optics is available to accommodate a wide variety of UVC applications.

Due to the integrated thermal structure (3-PAD) in the Flip Chip LED and the Metal Core PCB, Violumas LEDs achieve rapid thermal dissipation rates and lower thermal resistance values. As UVC LEDs generate immense amounts of heat and require

substantial cooling solutions, this technology is critical for more reliable, compact, and long-lasting UVC LED systems. It also allows Violumas UVC LEDs to withstand a nominal driving current of 700mA per LED chip, at which the LED maintains >70% of its original intensity after 10,000 hours of continuous operation.

With the continual development of high performance UVC LEDs, Violumas aims to accelerate industry adoption by providing a wide variety of products which can be suitable for any application from spectroscopy to disinfection.

About Violumas

Based in the heart of Silicon Valley, Violumas provides full-service UV LED products and solutions from UVA to UVC (405nm to 265nm). Our patented chip technologies allow us to engage in unparalleled applications of ultraviolet technology with more powerful and reliable UV LEDs. With capabilities in optical, mechanical, and thermal design, Violumas is a full-service, one stop-shop solutions provider for the UV LED market. ■

Breakthrough CV28D LEDs with Patented FusionBeam™ Technology

www.casambi.com

First LED in the Industry to Combine the Best of Through-Hole and SMD Technologies to Deliver Unmatched Clarity and Contrast.



Cree LED, a Penguin Solutions brand (Nasdaq: PENG), today announced the launch of its new CV28D LEDs with FusionBeam™ Technology, a groundbreaking advancement for the LED signage market. The CV28D LED combines the best of through-hole and surface-mount (SMD) RGB

LED technology, delivering superior directionality, image quality and resolution in a robust, easy-to-assemble package. This innovation marks a major leap forward for information displays, providing unmatched clarity and contrast. With this high resolution, CV28D-enabled signs can now display icons, photos, logos and even video, bringing unprecedented versatility to signs that can currently only display text or simple shapes.

FusionBeam Technology: Full-Color Brilliance, Enhanced Directionality

At the heart of the CV28D's performance, FusionBeam Technology simultaneously blends individual RGB LED dies into a single, uniform color and then sends it only to the intended audience. Color non-uniformity is up to 18 times better than existing RGB SMD signage LEDs, which previously could only achieve consistent color uniformity in one direction—either side-to-side or up-to-down. Using FusionBeam Technology, CV28D delivers vivid, accurate colors in all directions, elevating image quality even at close distances.

The CV28D LEDs also feature advanced directionality, focusing light precisely where it's needed – on the intended viewer – while reducing light trespass and pollution to four times lower than standard RGB SMD LEDs. With this new technology, CV28D LEDs ensure clearer, brighter displays without misdirecting light to the sky, ground or neighboring buildings, making it ideal for areas with strict light pollution regulations.

Unrivaled Image Quality and Resolution: A New Era for Information Signs

Compared to traditional through-hole LEDs, which struggle with low resolution and poor color blending, the CV28D enables displays with 2.5 times the resolution, equivalent to the leap from standard definition 480p to full HD 1080p video. The dark black package of the CV28D enhances contrast, delivering crisper text and sharper images than ever before, and the slim design, at just 4.3 mm in height, allows for the creation of thinner, lighter signs.

CV28D LEDs also retain all the advantages of SMD signage LEDs, including ease of assembly, one LED package per pixel and IP68-rated dustproof and waterproof reliability. This makes them ideal for a wide range of applications, including roadways, retail environments, sports scoreboards, poolside installations, lobbies and interior facades. Whether exposed to the elements or installed in high-traffic public areas, CV28D LEDs deliver long-lasting performance with Cree LED's renowned reliability and quality.

CV28D LEDs with FusionBeam Technology enable a new era of high-resolution information displays. This new generation of signs ensures that branding for businesses,

schools, churches and public spaces appears in full-color brilliance. The use of iconography also improves accessibility, ensuring clear communication for people of all reading abilities.

Cree LED Video Expertise

"We are proud to introduce the CV28D LEDs with FusionBeam Technology, the first LED solution to truly bridge the gap between through-hole and SMD technologies in the LED signage market," said Joe Clark, President of Cree LED. "By combining the best qualities of both, CV28D enables signage manufacturers to create displays with higher resolution, better directionality and improved durability, all while reducing light pollution. FusionBeam Technology LEDs represent the next frontier for LED information signs, and we're excited to see how our customers leverage our technology in their future designs."

Cree LED, a Penguin Solutions brand, is a leading innovator in LED technology, providing reliable, energy-efficient solutions for displays and lighting across the globe. Known for pioneering key signage technologies such as waterproofing, high-contrast packages and tilted viewing angles, Cree LED's products are trusted in high-profile installations and are backed by an excellent global intellectual property portfolio.

About Cree LED

Cree LED offers one of the industry's broadest portfolios of application-optimized LED chips and components, leading the industry in performance and reliability. Our team delivers best-in-class technology and breakthrough solutions for focused applications in high power and mid-power general lighting, specialty lighting and video screens. With more than thirty years of experience, Cree LED develops products backed by expert design assistance, superior sales support and industry-best global customer service. ■

XDC and Lumileds Achieve a Breakthrough with MicroLED Driven MicroLED Display

www.lumileds.com

X Display Company (XDC®), a leading developer of semiconductor devices for displays, and Lumileds, a global leader in MicroLED technology, have developed a revolutionary 140 pixels per inch (ppi) microLED-driven microLED prototype display.

This first of a kind display technology marks a significant milestone for MicroLED displays in mobile consumer applications including smartwatches, smartphones, tablets, and PCs. MicroLEDs enable a significantly more



flexible and power efficient approach to display backplane architecture.

"We see a lot of potential for MicroLED displays in mobile consumer electronic devices" said Ross Young, CEO of DSCC. "This XDC and Lumileds breakthrough will improve the cost, power, and brightness display profile significantly as to help accelerate adoption of these technologies."

The new MicroLED display features a cost-effective and power-advantaged architecture that leverages a cluster drive system combined with MicroLEDs that measure just 13x20 μm^2 . The result is a peak brightness of 2360 cd/m^2 that offers an unparalleled viewing experience with stunning clarity, color, and contrast. Both the microLEDs and microLEDs are manufactured using cutting-edge production equipment that ensures industry-leading uniformity and yield rates. Notably, the mass transfer process employed in the development of these prototypes achieves an impressive 99.9998% microLED sub-pixel yield and a 99.992% microLED transfer yield. The processes used to manufacture the prototype are mass production ready.

"XDC's mass transfer, bonding, and display driving technologies have created new opportunities to transform the world of displays," said Brendan Moran, Sr Director of Display Technology at Lumileds. "Lumileds has successfully implemented XDC's transfer-ready microLED technology into our volume production LED fabrication facilities. Together, we are setting new standards in the microLED industry and advancing mobile display technology."

"This milestone is made possible by Lumileds's device expertise and manufacturing process discipline applied from the very start. The result is repeatable, high-quality microLED displays," said Matt Meitl, EVP and co-founder of XDC. "Our long collaboration has resulted in microLED displays sought by customers in the mobile device space."

XDC and Lumileds are pleased to announce that the microLEDs, microLEDs, and the advanced transfer equipment utilized in this prototype can be deployed for interested customers, paving the way for broader adoption of this technology in mobile consumer devices.

Boost your business success today by choosing ams OSRAM LEDs for your luminaires!

LEDs impact lifetime, photon flux, maintenance and much more – it's a fact.
Choose a fixture with ams OSRAM LEDs inside and benefit in the following ways:

- Get stable crop results thanks to low light degradation and spectral stability
- Reduce the risk of field failures thanks to the outstanding robustness of the LED
- Save money on energy thanks to market-leading LED efficiency
- Support European chip production and secure European food supply
- Have strong intellectual property to minimize financial risk for growers

OSCONIQ® P 3737 Family:

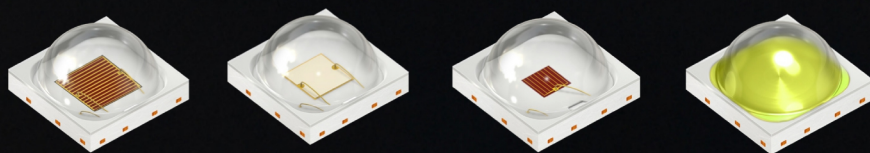

Visit us at: ams-osram.com/applications/lighting/agriculture-horticulture

Request your "LEDs Grow"
Info Package



am  **OSRAM**

About X Display Company:
XDisplay™ Company (XDC®), a technology developer, licenses intellectual property, sells microLEDs and PixelEngine™ components and Micro Transfer Printing Equipment that will power next generation displays. XDC is poised to capture a share in the semiconductor and display markets, delivering solutions that will make peoples' lives better. www.xdisplay.com

About Lumileds:
Lumileds is a global leader in LED and microLED technology, innovation, and solutions for the automotive, display, illumination, mobile, and other markets where light sources are essential. Our approximately 3,500 employees operate in over 15 countries and partner with our customers to deliver never before possible solutions for lighting, safety, and well-being. <https://lumileds.com>

Forge Partners with HongliTronic to Offer Innovative, High quality, Sustainable LED Solutions

www.forge.co.uk

Forge Europa has announced a strategic partnership with the LED OEM giant "HongliTronic", expanding its product offerings to include their extensive range of innovative and sustainable LED solutions. This collaboration brings together HongliTronic's cutting-edge LED technologies with Forge's LED tech experience and bespoke services to meet the diverse needs of customers across the UK and Europe.



Standard Portfolio with customer-based customization HongliTronic, ranked amongst the world's top three OEMs for LED components, offers a comprehensive range of products, including SMD, EMC, and COB packages. These solutions cater to a wide variety of applications, from general lighting to specialized UV technologies, making HongliTronic a versatile and essential partner for Forge's growing client base. HongliTronic develops standard solutions for global markets but remains open to customized client requirements.

Advanced Testing, Innovation, and Sustainability One of HongliTronic's core strengths lies in its rigorous product testing and commitment to innovation. With three fully CNAS / IES LM80 accredited state-of-the-art laboratories and LM80 testing data available across the range, HongliTronic ensures high reliability and durability across their product lines. Their focus on developing groundbreaking technologies, such as UV-C LEDs for disinfection and sterilization, allows them to remain at the forefront of industries like healthcare and air/water purification.

HongliTronic also prioritizes sustainability in its manufacturing processes. Their automated production lines, designed for efficiency, help reduce waste and energy consumption, ensuring that their LEDs not only meet industry standards but also support environmental goals, making HongliTronic and Forge the ideal LED supply partner.

Global Scale and Local Support As one of the largest LED manufacturers worldwide, HongliTronic leverages its large-scale manufacturing capabilities to offer competitive pricing and reliable supply chains. HongliTronic's global presence, combined with Forge's localized technical support, ensures that customers receive both top-tier products and responsive service.

David Scott-Maxwell, Managing Director at Forge Europa, said, "We are thrilled to welcome HongliTronic as a key partner. Their advanced technological solutions, combined with their focus on innovation and quality, perfectly align with Forge's mission to provide high-performance, high quality, eco-friendly lighting solutions to our clients. Together, we look forward to pushing the boundaries of LED innovation."

Alex Wang, Vice General Manager for HongliTronic, added, "Partnering with Forge allows us to expand our reach into new markets while leveraging their expertise in providing tailored solutions to customers. We are excited to collaborate and bring our innovative and sustainable LED technologies to Forge's diverse range of clients." ■

Folij Farms Selects Sollum's Dynamic LED Solution to Support Diverse Crop Production in Indiana Warehouse

www.sollumtechnologies.com

Folij Farms, led by first-time grower Bill Reece, has chosen Sollum Technologies' dynamic LED lighting solution to power his new indoor farming operation in Muncie,

Indiana, USA. Focused on growing leafy greens such as lettuce, kale, and herbs, Folij's large-scale warehouse will leverage Sollum's advanced lighting technology to optimize plant growth in a fully controlled environment.

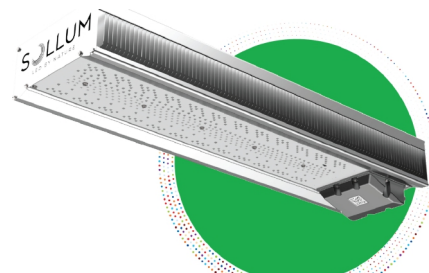

"We're excited to see Folij Farms adopt our solution," said Matthew Bonavita, Sollum's Vice President of Sales. "Bill's commitment to growing a variety of crops in an efficient and sustainable way aligns perfectly with what our dynamic lighting offers. We're confident that Sollum's technology will help Folij Farms meet its production goals, both now and in the future."

What initially drew Bill to Sollum was the exceptional flexibility offered by Sollum's SUN as a Service® (SUNaaS®) cloud platform, especially with regards to its multi-zoning capabilities that allow each production zone to benefit from a custom dynamic light recipe. As Bill plans to diversify his crops, the ability to tailor light spectrums and intensity to suit each one was a key factor in his decision.

Another factor in Bill's decision to adopt Sollum's solution was his desire to provide healthier and more affordable food options to his local community, where limited access to fresh produce has many relying on fast food due to the lack of alternatives. "This project isn't just about farming, it's about making healthy, pesticide-free produce accessible to people who need it the most," Bill said. "Sollum's technology allows me to apply the best lighting to each crop, ensuring optimal growth and making our vision a reality. We tested and reviewed a number of lighting solutions and Sollum offered a far superior option for us."

About Sollum Technologies
Sollum Technologies designed the only 100% dynamic LED lighting solution that modulates the full spectrum of the Sun's natural light to illuminate closed environments such as greenhouses, research centers and laboratories. Sollum's award-winning, turnkey solution consists of internet of things, AI-powered light fixtures that are controlled by Sollum's proprietary SUN as a Service® cloud platform. Sollum's distinctive proposition is a fully scalable cleantech solution that evolves with business needs and multi-zone light management, with each zone benefiting from automatic dimming of an unlimited number of light recipes; this is why it provides unparalleled value in terms of energy savings

and, additionally for greenhouse growers, increased productivity, and superior produce quality. Founded in 2015, the company is headquartered in Montréal (Québec, Canada), where its design, development, and manufacturing activities are concentrated, and has a representative office in Leamington (Ontario, Canada). ■

A Research Team from ams OSRAM and Fraunhofer Wins the Deutscher Zukunftspreis (German Future Prize) for Digital Light

ams-osram.com

Germany's President Frank-Walter Steinmeier honored the winners of the Deutscher Zukunftspreis 2024 at a formal ceremony in Berlin. The award was presented to a team of experts led by Dr. Norwin von Malm and Stefan Grötsch from ams OSRAM and Dr. Hermann Oppermann from the Fraunhofer Institute for Reliability and Microintegration IZM for the technological implementation of their idea — an LED matrix that turns car headlights into projectors. The LED technology developed by the team opens up new possibilities for innovative designs thanks to its high-resolution light distribution and its energy efficiency.



As part of their Digital Light project, the researchers and their teams have completely rethought intelligent LED technology and established a basic technology that enables numerous new applications, even beyond car headlights. Dr. Norwin von Malm and Stefan Grötsch from ams OSRAM and Dr. Hermann Oppermann from Fraunhofer IZM have developed a light source that is smaller, lighter, more efficient, more intelligent and more precise in its light output than conventional light sources. The new system will allow car headlights, for example, to illuminate the road ahead precisely and brightly without blinding or endangering oncoming traffic or pedestrians. A conventional low-beam/high-beam combination is not an option here because it must be possible to control the light's spatial distribution and for the light itself to adapt to the respective situation. To achieve this, the new headlight does not use two light sources like

conventional headlights. Instead, it relies on 25,600 LEDs in a matrix of 320 x 80 points, where each individual LED can be controlled with a digital signal. In combination with a special lens, this creates a headlight that works much like a video projector.

Compact design and high efficiency
The new system requires minimal installation space and is highly efficient since only the LEDs that are actually required for the desired light distribution are switched on. Systems with passive light modulation, by contrast, rely on shading, meaning that the light source is always on at full power, and the undesired light is filtered back out. However, this is an inefficient solution, since it involves generating unnecessary light. Furthermore, the generated heat must be dissipated, which requires large and expensive cooling systems. The new system prevents these losses from occurring in the first place.

Increased safety through projected pictograms
To increase safety, ams OSRAM and Fraunhofer have come up with something special: Their headlight not only provides precise and efficient light for the road ahead; it also acts as a projector and can project pictograms onto the road, e.g., a snowflake if there is a risk of frost or a specific symbol for wrong-way drivers.

Digital Light — intelligent LED technology for the world of tomorrow
Light-based information opens up many new use cases for the team's LED matrix, which can be controlled via a digital system. Examples include optical data communication between computer chips, e.g., in data centers for AI applications, or augmented reality (AR). Here, the light matrix could be used as a virtual monitor for AR glasses, where digital information is displayed in the user's field of vision in addition to the real-world environment. A compact design and energy efficiency are essential here since AR glasses must be lightweight and have a long battery life. These use cases demonstrate the enormous potential of Digital Light when it comes to transforming the ways humans and electronic devices interact.

Deutscher Zukunftspreis — paying tribute to innovative achievements in engineering and science
"I extend my best wishes to the teams led by Dr. Norwin von Malm and Stefan Grötsch as well as to Fraunhofer IZM on this outstanding award. Receiving the German President's Deutscher Zukunftspreis for our intelligent LED solution Digital Light, after a first award in 2007, is a special distinction for the entire Fraunhofer-Gesellschaft. The award demonstrates the enormous innovative strength of ams OSRAM and underlines the importance of intelligent lighting and sensor technologies for our digital society of today

and tomorrow," said Aldo Kamper, CEO of ams OSRAM.

"My sincere congratulations to the winning team from ams OSRAM and Fraunhofer IZM on this great award," said Prof. Hanselka, President of the Fraunhofer-Gesellschaft. "As part of their Digital Light project, the researchers have done more than develop a groundbreaking technology that opens up new possibilities for efficiency, safety and design. They have also provided a first-class example of the innovative strength that comes with transferring cutting-edge scientific findings to practical applications through the collaboration between research and industry. The Fraunhofer IZM team has clearly demonstrated the dedication, creativity, pioneering research and entrepreneurial spirit that characterizes the Fraunhofer-Gesellschaft and forms the basis of our success. Being awarded the Deutscher Zukunftspreis is a great success for the whole team and shows the extraordinary work that has gone into this project."

Awarded annually since 1997, the Deutscher Zukunftspreis is one of the most prestigious accolades for scientific achievement in Germany and includes 250,000 euros in prize money. It celebrates outstanding achievements in the fields of technology, engineering, and science that result in products that are ready for applied use. Each year, a prestigious jury goes through a multi-stage process to select three research teams and their innovative idea from a wide range of projects. These three teams proceed to the final round, the "circle of the best." In addition to innovation, the jury also evaluates the economic and social potential of the project. This is the tenth time that Fraunhofer has been awarded the Deutscher Zukunftspreis, with Fraunhofer IZM receiving the prize for the first time. ■

XLamp® XP-L Photo Red LEDs — Top Tier Efficiency for Next-Gen Luminaires

www.cree-led.com

Cree LED is committed to delivering innovative lighting solutions for horticulture and agriculture, where tailored lighting is essential for maximizing yields. Unlike traditional lighting for human vision, these systems require application-tuned spectral content, high efficacy and long lifespans.

Cree LED's advanced products offer industry-leading efficiency and reliability, designed specifically for these unique applications.

Introducing the XLamp® XP-L Photo Red S Line LED

Coming soon, the XLamp® XP-L Photo Red S Line LED is set to redefine horticulture lighting. Designed for next-generation luminaires, this new LED delivers outstanding efficiency and durability, empowering growers to achieve superior results.

- **Exceptional Efficiency**
With a typical Wall-Plug Efficiency (WPE) of 83.5% at 700 mA and 25°C, the XP-L Photo Red S Line LED offers a 6% efficiency boost over the XP-G3 Photo Red S Line LEDs. This extra performance can be used to lower Photo Red LED count in luminaires by 35
- **Unmatched Durability**
Built with advanced S Line technology, these LEDs feature outstanding sulfur and corrosion resistance, making them ideal for harsh greenhouse environments.
- **Seamless Upgrade Path**
Featuring the same 3.45 x 3.45 mm XP footprint as XP-G3 Photo Red S Line LEDs, the XP-L Photo Red ensures an easy upgrade for existing systems. Engineered for Reliability and Performance



Cree LED's S Line LEDs are designed for demanding horticulture applications, ensuring:

Superior system reliability through rigorous switching and dimming cycles. Long-lasting performance derived from proven outdoor lighting technology. Reduced maintenance costs and improved ROI for greenhouse operators. Maximize Your Yields with Cree LED

Cree LED continues to expand its portfolio of XLamp horticulture LEDs, delivering cutting-edge solutions for modern agriculture. From vertical farming to greenhouses, our S Line LEDs promise extended operational lifespans, heightened efficiency and optimized yields, helping growers thrive in any environment.

About Cree LED

Cree LED offers one of the industry's broadest portfolios of application-optimized LED chips and components, leading the industry in performance and reliability. Our team delivers best-in-class technology and breakthrough solutions for focused applications in high power and mid-power general lighting, specialty lighting and video screens. Cree LED develops products backed by expert design assistance, superior sales support and industry-best global customer service. cree-led.com ■

A Look Back at LiGHT 24 With Artist Frankie Boyle

www.frankieboylestudio.com

Visitors to last year's LiGHT 24 exhibition, held on the 20th and 21st of November at the Business Design Centre in Islington, London, received the unique opportunity to view the never-before-seen art installation 'Intra-spectrum' by artist Frankie Boyle, powered by leading architectural lighting manufacturer formalighting.



Frankie Boyle is a renowned experiential creative director and artist specializing in immersive and experiential design, with a profound focus on light and color theory. With over a decade of experience in the event and lighting industries, she is recognised for crafting innovative installations and experiences that guide audiences through transformative emotional journeys.

This was Frankie's first time creating an art installation for a trade show, and she shares the learning curves that came along with this project. Frankie says, "Intra-spectrum was artistically one of the most challenging installations I have ever created. This installation was about painting with light, like an artist that works with paint and canvas, you never know what the outcome is going to look like until you get there, this installation was no different. One of the biggest challenges when working with light is that clients will often want to know what the final piece is going to look like before an installation begins, but light interacts differently dependent on materials and space.

Frankie's work revolves around human behaviors, and the exclusively created Intra-spectrum installation aimed to ignite and resurface memories and emotions as visitors moved through the space. Frankie says, "Our goal was to highlight the reflection and refraction of the light and how it made people feel, creating something for people to experience and enjoy, rather than focusing on the products themselves in contrast to the rest of the trade show. Light is a language that everyone speaks, on a subconscious level, and I get the most enjoyment from seeing the effects my installations have on people in person.

"It was an exciting challenge to bring together both architectural and entertainment lighting

to provide a moment in time where people could stop and pause and feel peace and tranquility within an overstimulating space of the trade show. The installation ignites your inner light, taking you on both a physical and emotional journey."

To create the kaleidoscope of vibrant colors and reflections in this artwork, Frankie used dichroic film, a material that exhibits different colors when viewed from different angles, creating a color-shifting effect. The lighting products provided by formalighting were the brand's Moto Zero and Cobra luminaires, which provided incredible CRI to bring out the rich color palette at work. The lighting was Casambi-controlled to create panning spots and soft movement that emulated the natural flow of water.

Sustainability was also at the forefront of this project, with the art installation designed to be reusable. Since the exhibition, the material has been disassembled and transported to Barts Health NHS Trust, a group of hospitals which provide vital services to over 2.5 million people in east London and beyond, to create bespoke artwork for the hospital to promote patient healing.

Frankie adds, "As a neurodivergent individual, sensory spaces were integral to my development, and I am proud that Intra-spectrum can be reused and rebuilt to provide sensory experiences to patients in hospital to support their wellbeing. It is an amazing continuation of the story of the installation to help people in the community while being sympathetic to the planet." ■

Tridonic: New Certification for Emergency Lighting

www.tridonic.com

Tridonic, a leading provider of emergency lighting solutions, is the first manufacturer to receive ENEC certification for its lithium iron phosphate batteries. The new certification scheme was developed by the responsible organisation ETICS (European Testing, Inspection and Certification System) and deployed by DEKRA.



The new ENEC mark for LiFePO4 batteries builds on the extensive tests and documentation relating to the safety of emergency lighting products at Tridonic. ■

ECOSYSTEM FOR Micro-optics

Enabling easy access to micro-optics

PHABULOuS manages an ecosystem for micro-optics with a marketplace, organisation registry and community section.

GATEWAY TO TECHNOLOGY

The ecosystem for micro-optics by PHABULOuS is a dynamic platform that connects technology providers with customers, enabling seamless access to cutting-edge solutions in micro-optics. Here you find offerings that include advanced tooling, customizable materials, and precision manufacturing processes, to facilitate breakthrough advancements and unlock the full potential of micro-optics.

DRIVEN BY MEMBERS

At the core of our ecosystem, we have members who bring together expertise, innovation, and collaboration across the entire micro-optics value chain. As facilitator for advanced micro-optics, we provide access to:

- A wide range of design and modelling tools and services.
- Specialized and customizable materials, including foils, inks, and substrates.
- Large-scale origination and tooling processes.
- A wide range of manufacturing capabilities from prototyping to high volume production and equipment.
- Application support as bridge between customers and the supply chain.

www.microoptics.eu | info@microoptics.eu

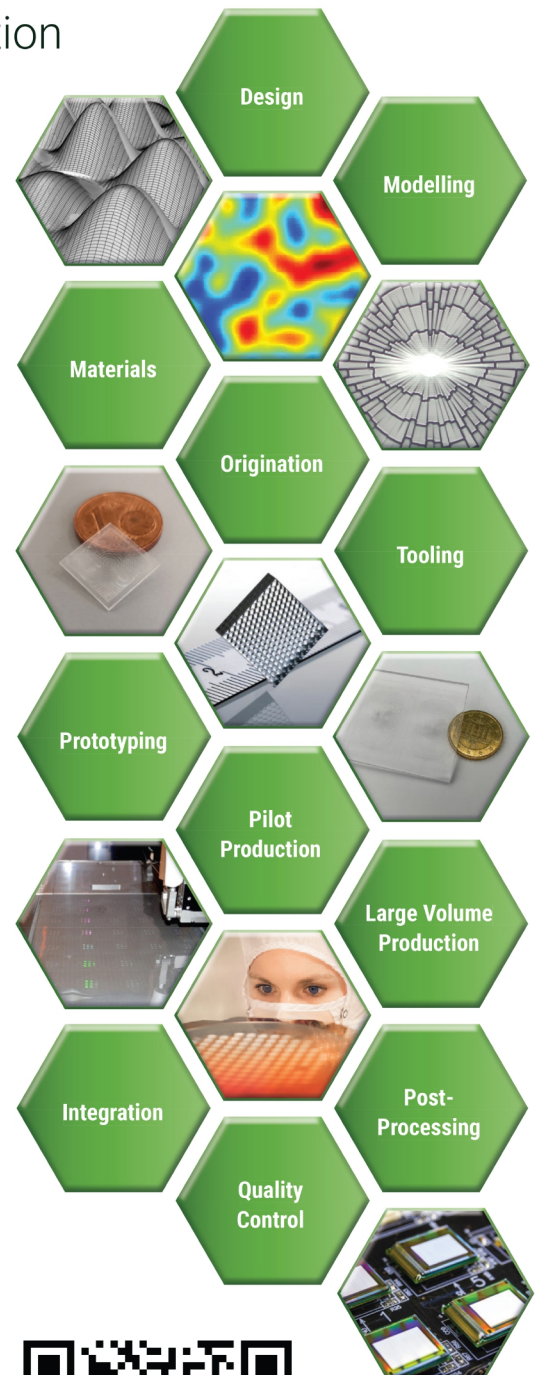

DALI Insights with DALI Alliance's Chair of the Board of the Directors – Arnulf RUPP, Governmental Affairs Director at Inventronics



Arnulf Rupp:

“Wireless DALI+ is a game-changer for lighting controls, enabling energy efficiency and flexibility in renovations without the need for costly rewiring.”

In this exclusive interview, Arnulf Rupp, Chair of the Board of Directors at the DALI Alliance and Governmental Affairs Director at Inventronics, shared his unique insights into the evolution of DALI technology, its groundbreaking applications, and the transformative potential of DALI+. With an illustrious career in the lighting industry, Arnulf reflected on the future of wireless lighting controls and discussed how DALI is shaping the path toward sustainability and innovation in lighting solutions. This is an unmissable read for anyone interested in the future of lighting.

dali-alliance.org

LED professional: The first thing we would be interested in hearing about is your career path and how you ultimately became Governmental Affairs Director at Inventronics.

Arnulf RUPP: I spent most of my professional career in the lighting industry. After finishing my physics degree at the Technical University in Munich, I started my professional carrier in research and development for automotive high-pressure lamps at OSRAM. It was an amazing learning experience which included understanding the fundamentals of plasma physics of discharge lamps, circuit design for power electronics driving discharge lamps and even some aspects of production equipment development. Mastering the complexity of the interfaces between all these elements and the eminent need to agree on interface specifications inside the company as well as with customers became my passion. When the transition from classical lamps to LED started, I had the opportunity to gain business and managerial experience while working in the corporate strategy department as an inter-company management consultant and later in marketing and business development roles in the newly established LED business units of OSRAM. During that time, I also went through an executive MBA program with the University of Augsburg in cooperation with Joseph M. Katz Business School in Pittsburgh. I experienced that working with industry alliances and associations can be a powerful tool for business development, especially in the digital and connectivity related industry. When I moved to Inventronics, I became governmental affairs

and intellectual property management director. As part of this role, I'm also acting as the chair of the board of directors in DALI Alliance, as board secretary in the Thread Group and as a member of the board of directors of LightingEurope.

LED professional: It's a real opportunity to be able to discuss lighting controls and, specifically, DALI with you. In this interview, we want to focus on wireless DALI, also known as DALI+. Before we dive in, though, we would like to clarify some terminology for our readers. What exactly do the terms DALI, DALI-2, D4i, and DALI+ mean?

Arnulf RUPP: Indeed, the different logos and trademarks which were added over the years may be confusing. DALI Alliance is the global consortium of lighting companies developing and promoting the Digital Addressable Lighting Interface (DALI) protocol, which is based on the international IEC 62386 standard. The word DALI and the graphical DALI logo are globally protected trademarks of the DALI Alliance. They stand for the DALI technology as well as the organization.

In addition to the DALI technology and brand, DALI Alliance also maintains certification programs for different product categories known as DALI-2, D4i and DALI+. All products listed in the DALI certification database on the website under these certification marks have been diligently checked with test sequences provided by the alliance. These product related trademarks indicate for which use-case the product and the corresponding test sequence have been

designed for. All three certification programs cover LED drivers, input devices and application controllers, but for different connectivity scenarios.

DALI-2 products communicate with the "classical" 2-wire DALI bus. They are intended for lighting control systems covering a room, a floor or even a complete building with multiple DALI subnets. Depending on the national electrical code, the DALI wires may be included inside the electrical power cabling, e.g. inside a NYM5 cable, or they may come as extra data-cables. Typically, one bus power supply is connected to a DALI subnet, or the bus is powered by the application controller.

D4i products also communicate with a 2-wire DALI bus. The key difference is that a D4i system just connects products inside one luminaire or a small subsystem with a maximum of four LED drivers. This architecture is intended to make wired DALI / D4i products easily accessible from wireless controls eco-systems, such as Bluetooth Mesh, Zigbee, DALI+ (to be explained below) or other networking systems. All LED drivers and sensors inside the luminaire are automatically discovered in a "plug & play" way by the connectivity node of the wireless eco-system, also known as the D4i gateway or bridge. Bus power supply and DALI data features for metering and diagnostics are mandatory for all D4i LED drivers.

DALI+ products communicate using a wireless or IP network carrying the same DALI commands known from its wired counterparts. Wireless DALI+ LED

drivers, input devices and application controllers include a radio transceiver for data transmission.

This enables DALI systems with both wired and wireless endpoints without the need for translating gateways. Wired and wireless sub-systems can still be connected using a DALI+ bridge. Both wired DALI and wireless DALI+ products are tested with the same rigorous certification tests, ensuring seamless interoperability. Because DALI+ also supports carrying DALI commands over IP (internet protocol) carriers, application controllers may be implemented fully in software, running on ubiquitous computing hardware.

LED professional: What were the main reasons for defining DALI as a wireless option, DALI+, and thereby expanding the ecosystem?

Arnulf RUPP: The global commercial building stock is growing steadily, but in developed countries only about one-fifth of new lighting products are installed in new buildings. Most new lighting products are installed in buildings which are built already. Under the pressure to reduce carbon footprint, renovation will become even more important in the coming years. Lighting has great potential to contribute to making commercial buildings more energy efficient. But renovation of buildings has its own challenges. There may be limited budget for re-wiring if no major renovation is planned. Power cables are there, but the extra DALI cables may not be present or only be partially available. Historic structures with strict preservation regulations often prevent re-wiring. Since COVID-19, the need for flexibility and customization in commercial buildings is also increasing further.

These are all good reasons to consider wireless technology for renovation projects, avoiding the need for expensive re-wiring of the building while increasing flexibility for future use scenarios of the building. In addition to the technical needs of renovation, we are also facing that renovation often happens under strict time pressure or renovation is expected to happen while operations are ongoing. With an increasing shortage of skilled labor, simplification of the deployment process is of high importance. Wireless technology in many aspects is the answer to those challenges.

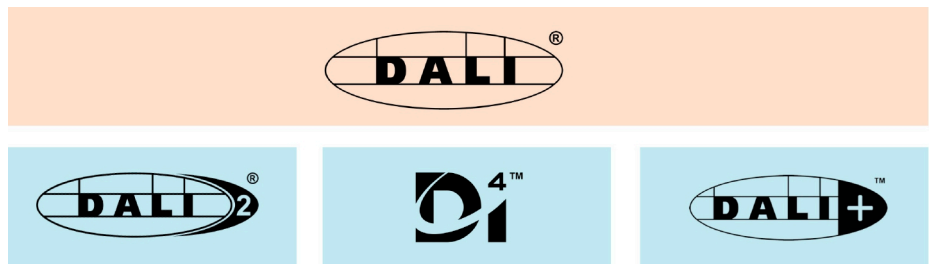

DALI Alliance, the open, global consortium of lighting companies aiming to grow the market for lighting-control solutions with the Digital Addressable Lighting Interface (DALI) protocol based on the IEC 62386 standard. **Logo of the Technology & Organisation (top).** **Certification Programs. (below)** **DALI2: (below/left)** 2-wire fieldbus for communication with LED drivers, sensors and controls as well as for (limited) power supply to some devices. **D4i: (below/middle)** Plug & Play* intra-luminaire bus for communication between LED drivers, sensors and communication nodes. * Plug & Play means automatic discovery without DALI commissioning and power supply for build-in devices. **DALI+: (below/right)** DALI commands carried over a wireless and/or IP-based medium with the same features and level of testing as DALI-2.

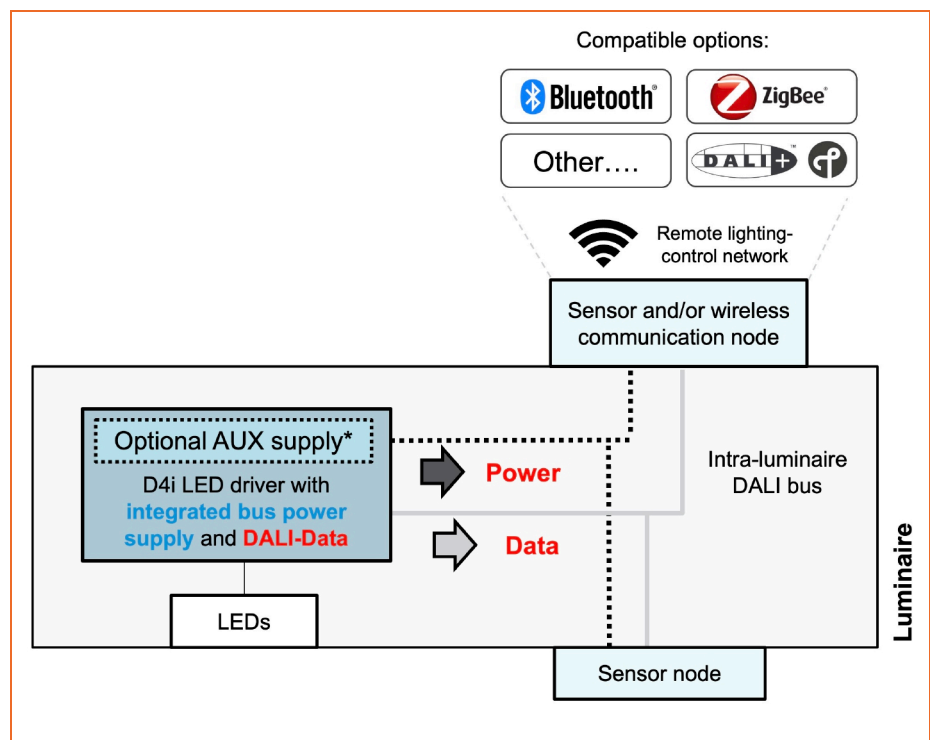

D4i: The full picture of Intra-luminaire DALI includes i) Power available to connective nodes & sensors, ii) Smart Data reporting to external network, and iii) Compatible with multiple wireless controls networks.

DALI Alliance is addressing the need for wireless lighting controls technology in multiple ways. It is not expected that we will see one dominating wireless technology in the foreseeable future. The technical requirements are different in different industry sectors and applications. Also, the pressure to stay compatible with existing products and ecosystems will not go away. With the D4i architecture, DALI Alliance has paved the way for multiple wireless connectivity eco-systems to use existing wired DALI technology in wireless controls systems. With DALI+ the alliance is adding an option to stay inside the DALI ecosystem for wireless as well. This is particularly useful in applications

where wired DALI-2 and wireless DALI+ will co-exist. But it is also an attractive choice for DALI members who want to enter wireless technology while protecting the investment they already made in wired DALI over the years. Because the DALI command set remains essentially unchanged in DALI+ and the technical and application experience related to it can be reused, it is a preferred way to evolve into wireless technology coming from DALI-2.

LED professional: What does the new ecosystem, including DALI+, look like, and what configurations can be achieved for rooms, buildings, and

cities? What are the system limitations of DALI+?

Arnulf RUPP: DALI+ technology enables the same rich lighting controls capabilities we already have with wired DALI-2. There are no limitations in the type of products and DALI specification parts that can be implemented with the underlying technical standard of DALI+. The international standard IEC 62386-104 defines how to implement all existing DALI features known from wired DALI with wireless and IP networks. This includes the commands for controlling LED light sources, input devices allowing control systems to react to environmental condition changes and user needs as well as application controllers.

However, it needs to be considered that the certification program allowing for the use of the DALI+ certification mark is not yet available for all DALI specification parts. At present, LED drivers including the DALI data extensions for energy metering and diagnostics, application controllers and the most important input devices can already be certified. Certification for DALI+ bridge products connecting DALI+ with classical DALI-2 and D4i is expected to start early in 2025. Because a bridge allows connecting any existing DALI product with a DALI+ network, it is a very important addition, making the full set of DALI features accessible to DALI+ application controllers. Emergency lighting, color control and more sensor types will follow.

LED professional: Let's also discuss sustainability as a crucial element of any new lighting solution. How does DALI+ support sustainable solutions, and can it be considered sustainable in the long term?

Arnulf RUPP: Wireless DALI is an important enabler to unlock the potential of additional energy savings and well-being for existing buildings. DALI+ is expected to significantly increase the deployment rate of lighting controls in renovation projects. It is well understood from life cycle assessment studies needed for the upcoming environmental product declarations that the dominant contribution to carbon emission from lighting systems results from the energy consumption during the use-phase of lighting products. In other words, any investment in energy savings with lighting controls translates into a strong and sustainable

environmental benefit. The possibility to reduce energy consumption without the burden of masonry work needed to re-wire the building not only offers a quick return on investment from a monetary point of view, but also from a carbon emission point of view.

For the DALI+ certification program, DALI Alliance made a choice for the Thread Protocol as the underlying wireless networking technology. Other suitable networking technologies may be added later for specific application needs. The specific strength of the Thread pro-

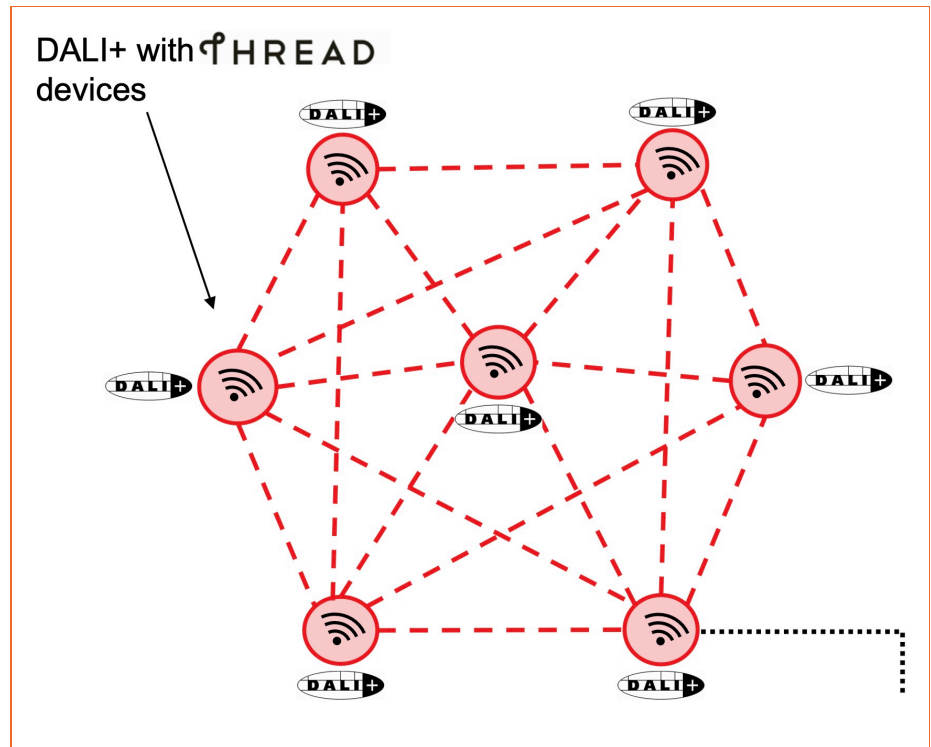

The entire DALI+ system communicates using the existing DALI language, initially via Thread as carrier. A DALI+ bridge allows application controllers in the DALI+ system to control, configure and query devices in a DALI wired system. Broad range of connectivity is available for BMS, Ethernet router, D4i and DALI2 subnets.

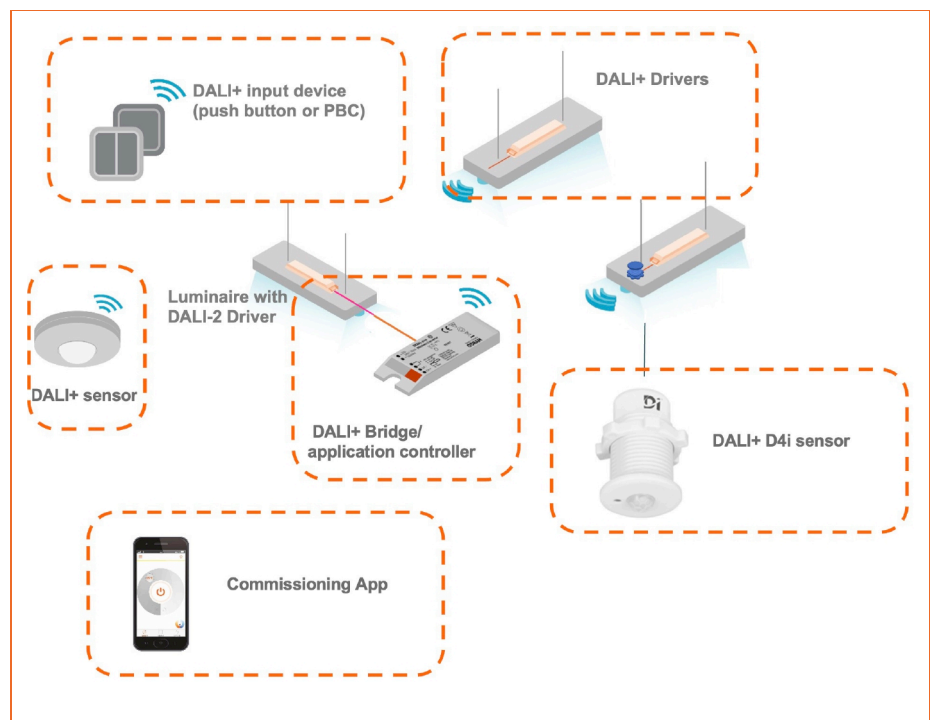

System structure with a DALI+ Bridge-Application Controller.

protocol is that it implements an IP capable low power mesh network. With that, DALI+ enables low energy consumption for the transmission of DALI commands and thus minimizes standby losses and overall energy consumption of the controls components.

LED professional: The complexity of systems is constantly increasing, and ecosystems are growing larger. How will systems with DALI+ or hybrid systems with many participants, actuators, and sensors be managed in the future?

Arnulf RUPP: As with any large networking system, DALI systems also require structuring networks into subnets and backbone networks. This is a known practice in DALI-2, where the address space of the protocol already limits the size of one subnet to 64 control gears and 64 control devices. Such a limitation does not exist in DALI+ with Thread, because devices can be addressed using their IPv6 address provided by the underlying network. The IPv6 address space is very large and would theoretically allow unique addresses for thousands of nodes per every square meter of the earth's surface. Still the common practice in IPv6 networks is structuring the network in smaller subnets tailored to the available throughput capabilities of the physical carrier technology. The benefit of the internet protocol is that the network structure is largely independent

from the application protocol and can even be changed without breaking the network or requiring re-configuration when the physical throughput limits are reached. This makes Thread based DALI+ networks extremely scalable and future proof. It would even allow sharing the network resources with other eco-systems such as KNX IoT or Matter, very much like different IT applications sharing the same WiFi network in office buildings today.

Such wireless shared sensor / actuator networks are not widely used today but may become a need in the future when the number of isolated wireless networks for different controls systems in a building grows further. Most wireless IoT networks use the license free 2,4 GHz band making interference unavoidable. Sharing the physical network using a common IP protocol can help avoid interference and reduce connectivity overhead.

LED professional: Security is a crucial aspect of all wireless solutions. Thread, which is now widely used, serves as the communication carrier. How secure is DALI+ in real applications?

Arnulf RUPP: DALI+ is well prepared for the growing cybersecurity needs and upcoming regulatory requirements in the different regions of the world. Thread itself is a secure by design network where no device can be added to the

network without proper authentication of the joining device. Communication is always encrypted using state of the art cryptographic methods. On top of the network level encryption, DALI+ adds another layer of symmetric application layer encryption effectively isolating the lighting network from any other devices and routers having access to the data transmitted in the same network. Both group communication as well as the unicast communication between devices benefits from the additional application layer security. Key deployment leverages a TLS based asymmetric encryption method.

Next to the cryptographic properties of the networking protocol, it is important that DALI members implement proper management of security vulnerabilities. DALI+ technology supports that process with a standardized method for delivering firmware updates that members can use to cope with any security vulnerabilities which may arise.

LED professional: There is an extensive certification program for DALI and DALI+ that verifies both data transmission and device behavior. What exactly does the DALI certification entail, especially for DALI+?

Arnulf RUPP: DALI Alliance requires all certified products to pass a sophisticated and highly automated test procedure with hours of interoperability and device level testing.

The unique strength of the DALI Alliance certification program is that not only reliable data transmission and compliance with the encoding requirements of the DALI language is checked, but also the physical output resulting from DALI commands is verified. For example, the proper implementation of the logarithmic dimming curve and the execution of fade rates and fade times are checked by the DALI test harness.

For DALI+ the certification program requires Thread certification for the underlying networking protocol and successful execution of the same application layer tests which would apply to the comparable DALI-2 product. In addition, special DALI+ tests have been developed for DALI+ command encoding rules and for DALI+ bridges translating between wireless and wired DALI.



Modern office lighting requires flexible equipment and illumination solutions. DALI+ is an excellent option for applications involving renovations, retrofitting, and adaptability.

LED professional: Of course we are also interested in the availability of DALI+ systems and devices. What does the further roadmap look like, and when can we expect to see the first DALI+ systems on the market?

Arnulf RUPP: Despite the fact that certification program for a subset of DALI+ device types has already been launched, there are still important parts missing from a certification program point of view. However, that does not mean that the industry has not implemented the technical standard yet. Products and systems using the underlying IEC 62386-104 standard already exist in the market and members of the DALI Alliance continue pushing for the further development of the technology and certification program with the target to introduce fully certified DALI+ systems in the future.

Considering the complexity of the technology and the long value chain, my estimate for fully certified DALI+ systems down to the level of luminaires and controls solutions with only certified DALI+ components ranges between late 2025 and early 2026. Meanwhile we will see more products implementing the technology and more product categories begin to be added to the certification program.

LED professional: Does the DALI Alliance ensure long-term support for DALI+ systems? How is this achieved, and is DALI+ actually an international standard?

Arnulf RUPP: The DALI Alliance is absolutely committed to make DALI+ a long-term available system with supply from multiple member companies. The underlying technical standard is already available as an international standard and the comprehensive changes and additions contributed by DALI members since the first publication of the IEC 62386-104 standard will also be made available as updates to the IEC document. The proposed changes to the IEC document are already available for download from the DALI Alliance website.

LED professional: In conclusion, we would like to know where one can find relevant information to delve deeper into DALI+. This includes designers, developers, and potential partners. What do you recommend for those interested in quickly, efficiently, and currently getting up to speed on this topic?

Arnulf RUPP: Introductory content about the DALI+ technology and published standards are available from the DALI Alliance website in the section

Standards » DALI+ overview. If you are considering the development of DALI+ products, the best way to get the most updated information is watching the DALI Alliance member webinars and if you are a DALI Alliance regular member, participating in the DALI+ workgroup.

As a planner or luminaire maker I recommend watching for publications from DALI members involved in DALI+.

LED professional: Thank you, Mr. Rupp, for your time and the valuable insights into the DALI world! We wish you much success!

Arnulf RUPP: Thank you for the opportunity to provide my viewpoints on DALI and DALI+ in particular. ■

For additional information, please visit dali-alliance.org.



From Vision to Reality: How Gewiss is Revolutionizing the Lighting Industry – Alfonso D'Andretta, Managing Director, BU Lighting at Gewiss



Alfonso D'Andretta

“Never compromise long-term strategic objectives because of short-term goals.”

In this exclusive interview, the Managing Director of BU Lighting at Gewiss reflects on his journey in the lighting industry, his leadership approach, and the company's ambitious direction following the acquisition of Performance iN Lighting. This strategic move enhances Gewiss' presence in key segments like office, industry, and urban lighting. He discusses innovations such as connected and human-centric lighting, sustainability, and smart city solutions, emphasizing the balance between technological progress and the quality of light. With a focus on leveraging new opportunities and tackling challenges, he shares his vision for the future of lighting and the importance of disruption in driving progress.

www.gewiss.com

LED professional: What drew you to the lighting industry, and how has your career path led you to your current role at Gewiss?

Alfonso D'Andretta: I started my professional career in the lighting industry back in 2008 when I joined Philips (now Signify). After about 13 years in multiple geographies and roles, primarily marketing, sales and operations, I had the opportunity to leverage my experience and apply it in a different domain, moving to an access control company as Chief Sales Officer. In 2024 I joined the lighting industry once again, taking an exciting assignment within an ambitious organization such as Gewiss.

LED professional: Can you share some insights into your leadership style? How do you balance operational demands with long-term strategic thinking?

Alfonso D'Andretta: Once I was told that a well-rounded manager is the one who can apply different management styles depending on the situation he or she is in. I always try to bear this in mind, connecting with the counterpart and reading the situation, to be as effective as I possibly can. Above this, there is one single rule I always try to stick to: never compromise long-term strategic objectives because of short-term goals. Like sailing, sometimes you need to adapt the sails to the wind, and in rough waters even adjust the route, but still keep functionally moving toward the final destination you have envisioned.

LED professional: Gewiss recently acquired "Performance iN Lighting." What strategic goals motivated this acquisition, and how does it align with Gewiss' broader vision for the lighting business?

Alfonso D'Andretta: The acquisition of Performance iN Lighting was motivated by Gewiss' commitment to significantly scale up its lighting business, through competencies, portfolio and coverage. It surely represents an important first step in this direction.

LED professional: What impact do you expect this acquisition to have on your market position, both in Italy and internationally?

Alfonso D'Andretta: The acquisition of Performance iN Lighting significantly reinforces Gewiss' position in the market, particularly in certain segments such as Office, Industry, Residential, Sport and Urban, and in certain geographies like Germany, France and Italy just to name a few.

LED professional: How will the product portfolios of Gewiss and Performance iN Lighting complement each other? Will there be any product line expansions or innovations as a result of the acquisition?

Alfonso D'Andretta: At Gewiss, 2024 was the year of a unique vision of light, in all its forms, a renewed proposal, a single point of reference for every lighting need in a new, unified lighting portfolio. The new proposal covers applications ranging from hospitality to retail and

healthcare, from office to industry, from residential to sport facilities, urban and large areas. An offering which combines performance with innovation and design, to deliver comfort, safety and efficiency. This is the direction we will keep investing in, in the years to come.

LED professional: What new opportunities in terms of technology or market segments does this acquisition unlock for Gewiss?

Alfonso D'Andretta: The acquisition enables access to new markets and segments to be leveraged, thanks to synergies within the lighting domain and beyond.

LED professional: The lighting industry is rapidly evolving, particularly with advancements in smart lighting and IoT. How is Gewiss positioning itself to take advantage of these trends?

Alfonso D'Andretta: Connected lighting will definitely play a key role in our strategy for the years to come. At Gewiss we are putting significant investments in this direction, with the objective of having a full suite of architectures designed around the specific needs of each segment. We believe that both vertical and horizontal integrations will be key for our customers to unlock the potential of their infrastructure.

LED professional: Sustainability is a key focus in many industries today. How is Gewiss incorporating sustainability into its product development and operations in the lighting sector?

Alfonso D'Andretta: Innovation is an integral part of the Gewiss DNA; it has thus made the decision to develop a responsible business model, which promotes respectful conduct towards people and the environment. Gewiss is committed to putting forward solutions, services and products that, starting from the design phase, take into account not just the market requirements but also the need for sustainability in every phase of their life.

In developing solutions, services and processes, Gewiss strives to offer a range that responds to the needs and expectations of our customers, in line with driving forces of sustainability and sustainable development. The aim is to develop innovative solutions, services, and processes with a specific focus on social, environmental and economic aspects. To define sustainable development criteria for our solutions, services and processes, Gewiss is inspired by the Pillars of Sustainability defined in the United Nations report, "Our Common

Future", identifying guidelines for each one.

In 2024 we concluded and obtained the PEP Ecopassport certification for the Smart range and further LCA studies are planned for next year to understand the environmental impacts of the products and possibly obtain third-party certifications.

LED professional: In your opinion, what are the most significant innovations we can expect to see in the lighting industry over the next few years?

Alfonso D'Andretta: In the last 15 years, the lighting industry has been revolutionized by the distributive advent of digitalization. I believe we have not seen it all yet. In fact, technology still offers space for further enhancements when it comes to performance and range of applications. This becomes even more true if applied to data enabled services. One

thing the industry has been losing on the way though, is the attention to the quality of light and its application. We always need to remember the massive impact light has on the community. We all need to bring the right attention back to the technical fundamentals of light, while capturing the potential of new technologies.

LED professional: How do you see the role of lighting changing in smart cities and urban development, and how is Gewiss contributing to this future?

Alfonso D'Andretta: Lighting has a massive impact on urban developments. It transforms areas making them welcoming and safe for people to come together and experience the community. Connected lighting brings an additional element to the equation, allowing people to engage with the space around them, thanks to adaptive lighting. Finally, for the municipalities a well-designed city lighting management system brings significant efficiency in maintaining the infrastructure, and better service for the citizens.

LED professional: With the increasing emphasis on human-centric lighting, how does Gewiss plan to integrate health and well-being considerations into its products?

Alfonso D'Andretta: Gewiss, in particular, Performance iN Lighting, is integrating health and well-being considerations into its lighting products by focusing on Human-Centric Lighting (HCL), which aligns with natural circadian rhythms to improve sleep, reduce stress, and enhance productivity. They are incorporating smart lighting systems that adapt to daylight conditions and individual needs, and using LED technology for superior light quality and energy efficiency. Additionally, Gewiss is committed to sustainability by minimizing the environmental impact of their lighting solutions, ensuring they promote both human well-being and ecological balance.

LED professional: What are the biggest challenges currently facing the lighting industry, and how is Gewiss navigating them?

Alfonso D'Andretta: As previously mentioned, a technological fast pace transformation such as digitalization offers



Performance iN Lighting project: MEDIATHEQUE LES 7 LIEUX - Bayeux - France.



Performance iN Lighting project: PRIVATE VILLA - Sanlúcar de Barrameda - Cádiz - Spain.



Performance iN Lighting project: MAFFEI PALACE - Verona - Italy.



Performance iN Lighting project: ARENA DI VERONA - EUROPEAN VOLLEY CHAMPIONSHIP 2023 - Verona - Italy.

great opportunities but also significant threats. As an industry, we should not forget the fundamentals of the quality of light and its application, while pursuing new dimensions enabled by the advancement of the technology. This way we really capture the full potential of light.

LED professional: Supply chain issues have affected many industries globally. How has Gewiss managed these challenges, and what measures have you implemented to ensure continuity in production and innovation?

Alfonso D'Andretta: This is undoubtedly a fact. Dependence on the supply chain of certain components is a point of constant attention. We at Gewiss take our supplier basis extremely seriously. We see and manage it as an extension of our own organization. This, together with thorough planning, gives us solid control and mitigates possible disruptions in the value chain.

LED professional: What role does innovation play in Gewiss' strategy to stay competitive in the global lighting market?

Alfonso D'Andretta: A company without innovation has no future. Innovation is at the very core of what we do through a continuous innovation cycle that funnels ideas to actual projects and ultimately offers solutions for the market. The cycle can be longer or shorter, depending on the complexity. We balance speed depending on the horizon of the specific project. Note that innovation is not only what we bring to the market, but also how we operate, the way we integrate our solutions within a specific vertical and the means we use to deliver better service to our customers.

LED professional: With energy efficiency becoming a critical focus for many industries, how is Gewiss adapting its products to meet stricter regulatory requirements?

Alfonso D'Andretta: We are extremely active when it comes to anticipating regulatory requirements. We actually advocate for raising the bar when it comes to the quality of light in all its dimensions, from components to application.

LED professional: What has been the most significant lesson you've learned in your time as Managing Director at Gewiss?

Alfonso D'Andretta: The most significant lesson is the one I'm going to learn next. What I mean is; I'm constantly learning. Every day. I'm truly blessed in this sense. To quote the founder of the company himself, Cav. Domenico Bosatelli: Aim for the stars. You won't reach them but they will guide you.

I find it a beautiful summary of what we do, and will keep doing.

LED professional: How do you envision the future of lighting in the next 10 years, and what role will Gewiss play in shaping that future?

Alfonso D'Andretta: I personally believe that the lighting industry has a brilliant future. There is so much more we can do to make new technologies evolve and contribute to society with better and more sustainable light. At Gewiss we definitely want to make a significant contribution, and we will be working towards this.

LED professional: What advice would you give to young professionals entering the lighting industry today?

Alfonso D'Andretta: One word: Disrupt. This is what young professionals are for in this, and any other industry.

LED professional: From a personal perspective, what excites you most about the direction the lighting industry is heading in?

Alfonso D'Andretta: The tremendous potential of light, in all its shapes. ■

For additional information, please visit www.performanceinlighting.com.

GUELL

Outdoor professional floodlights



GUELL ZERO



GUELL 1



GUELL 2



GUELL 2.5



GUELL 3



GUELL 4



GUELL

GUELL is a complete series of LED floodlights designed to offer high performance lighting solutions.

They can be installed in the most diverse contexts: small sports facilities, industrial and commercial exteriors.

The versatile products fit perfectly into lighting projects.

The GUELL guarantees total cohesion of the range. The range offers different formats (GUELL ZERO / 1 / 2 / 2.5 / 3 / 4), with 5 different optics, with several electrical connection options and numerous dedicated accessories

PERFORMANCE
iN LIGHTING

powered by
GEWISS

www.performanceinlighting.com

Pioneering Progress: Würth Elektronik's Highlights and Innovations Unveiled at electronica

LED Professional Editors

At this year's electronica trade show, Würth Elektronik [1] left an indelible mark with its comprehensive showcase of cutting-edge technologies and innovative solutions. The company's 400 m² booth served as a hub for live demonstrations, knowledge sharing, and collaborative engagement. Highlights included the unveiling of the REDEXPERT digital design platform and the new MyWE customer platform, both providing invaluable resources for developers and engineers. Visitors were offered free lab samples to test Würth Elektronik's components in their own development labs, demonstrating the company's commitment to hands-on collaboration. Partnerships with industry leaders such as Analog Devices, Infineon, and Texas Instruments further underscored Würth Elektronik's role in advancing reference designs and industry standards.

The booth also featured an impressive array of product innovations, ranging from advanced inductors and power modules to optical sensors and radio modules. The introduction of the WL-ICLED series, a new line of RGB LEDs with integrated controllers, showcased Würth Elektronik's expertise in display technology and lighting solutions. Additionally, the company's contribution to sustainability through innovative microalgae cultivation systems and its Lighting Development Kit 2.0 highlighted its commitment to addressing global challenges with technology. This post-show report explores these groundbreaking developments, reflecting Würth Elektronik's mission to create impactful solutions and redefine industry standards.

Introduction

The global player's strong service orientation was clearly apparent in many aspects of its trade show presence. Trade visitors were able to experience live demonstrations of the REDEXPERT digital design platform and the new MyWE customer platform at the 400 m² booth. Developers who were looking to use components for their own projects could order free lab samples at the trade show booth and test them in their development lab the next day. Collaboration with IC manufacturers, which was crucial for developing reference designs, was also featured at the trade show. Partners present at the booth included Analog Devices, Infineon, Microchip, Onsemi, STMicroelectronics, and Texas Instruments.



Alexander Gerfer, CTO at Würth Elektronik eiSos.

Würth Elektronik also contributed valuable knowledge sharing with its practice-oriented reference guides. Alongside the brand-new "ABC of Shielding", an expanded and revised version of the "Trilogy of Connectors" was presented at electronica. Those interested in power supply

design found valuable insights and tips for practical implementation in the newly published "DC/DC Converter Handbook".

"Those who know us are aware that we're so much more than just a component manufacturer," mentioned Alexander Gerfer, CTO at Würth Elektronik eiSos. "What drives our company's success is our high-quality, durable products, of course. But, of equal importance to us are services, such as knowledge transfer and targeted development support, for example through pre-compliance measurement. Creating Together is our mission, especially at this important industry event."

"What drives our company's success is our high-quality, durable products, of course. But, of equal importance to us are services, such as knowledge transfer and targeted development support, for example through pre-compliance measurement. Creating Together is our mission, especially at this important industry event."

ALEXANDER GERFER

"More than you expect' is also there to be found in our comprehensive product range, whether from stock as standard, or as custom components," Gerfer affirmed. "Würth Elektronik offers everything from a single source: products from the fields of passive components, electromechanics,



Alexander Gerfer (left), CTO at Würth Elektronik eiSos, and his team at their electronica booth in Munich.

optoelectronics, power modules, digital isolators, thermal management, as well as wireless connectivity & sensors and components for the automotive sector. We offer more of everything: more partnership, more solutions, more service and more possibilities.”

A wealth of product highlights was exhibited at the Würth Elektronik booth:

- Single Pair Ethernet Power over Data Line: reference design and demo board
- WE-MXGI SMT power inductors: Further designs for this new series of inductors were unveiled at the trade show. They are made of an innovative metal alloy with extremely low RDC and AC losses. The compact, magnetically shielded design is optimized for high switching frequencies in excess of 1 MHz and is ideally suited as a DC/DC converter for high-current supplies and field programmable gate arrays.
- Transformers for battery management systems as well as AC and DC charging stations: ideally suited for applications such as wallboxes and energy storage systems
- High-current and high-temperature inductors: with an operating temperature

of up to 150°C and without thermal aging effects, for example, for DC converters in power supplies

- Mag13C-VDMM type power modules: with a wide input voltage range of 3.5-60 V for 48-V industrial bus applications
- WE-TORPFC PFC chokes: for charging stations or solar power system inverters
- WL-OSEN: a new optical sensor with a typical detection distance of 1 mm for optical switches or touch applications
- Radio modules & sensors: FeatherWing development boards
- Another focus is on crystals and oscillators, such as the ICPT-1 rubidium oscillator, as IQD Frequency Products is once again a co-exhibitor this year.
- High-current contacts for automotive applications and REDCUBE for direct current motors
- New COAX connectors
- Custom solutions: for connectors, inductors, transformers, crystals and oscillators, ferrites and inductors, thermal management, capacitors, or automotive-qualified components.

Components from Würth Elektronik are usually available straight from stock, even in larger quantities.

WL-ICLED, a New Series of RGB LEDs with Integrated Controller

Würth Elektronik now offers WL-ICLED [2], a new series of RGB LEDs with integrated controller (IC). The components, controllable as pixels, combine a red, green and blue LED with a programmable controller IC. The intelligent LEDs, available in six designs, are individually controllable in their pixel color and brightness levels from 0 to 100 percent.

Over 16 million different color and brightness levels can be set with the new RGB LEDs. They are compatible with open source libraries such as FastLED. As fewer components (such as series resistors) are required, display solutions with intelligent LEDs are not only quicker to implement, they are more compact than solutions with separate LEDs. Applications for the components include signal control systems, full-color matrix displays, audio and gaming systems, indoor lighting and displays on e-mobility charging stations. The following designs are now available: 1616 Chip LED compact, 2020 Chip LED compact, 3210

Chip LED Side View, 2121 PLCC6 with bypass, 5050 PLCC4 and 5050 PLCC6.

Moisture protection

In contrast to comparable solutions already on the market, Würth Elektronik's intelligent LEDs with an MSL3 moisture sensitivity level (rather than MSL5 or MSL5a commonly found) are less moisture sensitive during assembly. Some of the components comply with protection class IPx7, so they can even be submerged for a short time without damage. Another quality feature of the LED chipsets is their gold coating on the 'Chip LED' models and silver coating for PLCC models, which leads to better solderability. Available in 8-bit and 12-bit versions, the intelligent LEDs offer more options for PWM resolution.

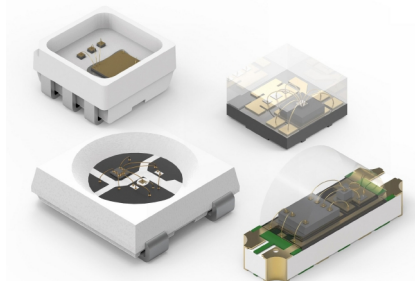

Family-WL-ICLED.

Standardized qualification

Photobiological test reports in accordance with EN 62471:2008 and IEC 62471:2006 are available for all models in the product group. This may be relevant if the intelligent LEDs are used in toys. Würth Elektronik does not target the automotive market with the new product – but the tests and qualifications were carried out in accordance with AEC Q102-003 in order to provide customers with objectively comparable specifications.

The LEDs with integrated controllers can now be ordered from stock without a minimum order quantity. Developers can receive free samples.

Display Technologies

At the electronica trade show, Würth Elektronik showcased a wide range of innovative developments in display technology, emphasizing advancements in Mini-LED, μ LED, and ICLED technologies.

Mini-LED Displays: Würth Elektronik presented Mini-LED technology, known for its exceptional brightness and color accuracy. By enabling precise control of individual lighting zones, these displays deliver outstanding image quality and energy efficiency, making them ideal for applications

requiring high contrast and vibrant color representation.

μ LED Displays: The company also highlighted μ LED technology, which represents a significant milestone in display innovation. Featuring extreme pixel density and individual pixel control, μ LEDs provide impressive resolutions and color depths while maintaining high energy efficiency. These displays are particularly suited for demanding fields such as medical technology and high-end consumer electronics.

ICLED Displays with Optical Sensors:

ICLED displays with integrated optical sensors were another focus of Würth Elektronik's exhibit. These displays enable new functionalities by capturing environmental data, such as light intensity and gestures. This opens up interactive and adaptive possibilities for applications in smart lighting and data visualization.

ICLED Color Calculator: A notable highlight of the booth was the ICLED Color Calculator, a tool designed to achieve precise color corrections. By calculating PWM values based on target coordinates in the CIE 1931 color space, this tool ensures accurate color reproduction, saves time, and enhances the integration of ICLEDs into complex applications.

Superfood in a New Light

Already this year, at the Digital Life Design (DLD) in Munich, the international conference and innovation platform, Würth Elektronik announced a new cooperation with Agile Solutions: A highly efficient LED lighting system for microalgae production which has been developed together with the system partner. Up to seven times more protein-rich than tofu, Spirulina is a real superfood, as well as being a very important raw material for the food and pharmaceutical industries. Optimal growth conditions are needed for efficient phototrophic algae production in Germany, and Würth Elektronik's cooperation aims to achieve this, as promotion of new ideas and start-ups is an important pillar of the global player's successful business model.

LED lighting is crucial for yield: Alexander Gerfer, CTO at Würth Elektronik eiSos, and Martin Havers, founder of Agile Solutions, explained the concept: Algae cultivation in Germany takes place in closed indoor systems under controlled conditions. Plant-optimized lighting is crucial for yield. Agile Solutions – In cooperation with Würth Elektronik – has developed a special LED cur-

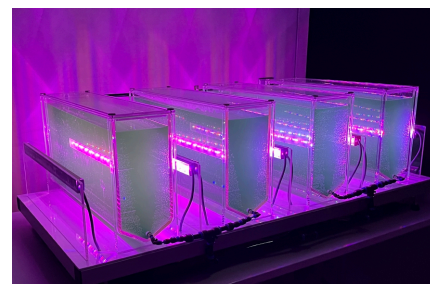

Pilot plant for microalgae cultivation.

tain using 700 mid-power LEDs to provide the algae cultures with the ideal lighting.

"LED lighting technology, in general, and plant-optimized lighting, in particular, is not new territory for us," explains Alexander Gerfer. "With our Connected Vertical Farm prototype, we have already demonstrated, on a small scale, how plants grow and thrive excellently under ideal LED lighting. And underwater, it works in a very similar way. Thanks to our targeted support, Agile Solutions was able to significantly shorten the development time and quickly bring a sophisticated lighting system to market with integrated self-diagnosis and optimized load distribution."

Microalgae products are expected to see a high market growth of 10.9% on average, particularly in Europe. Germany takes a leading role here. With 16 microalgae-producing companies, we are pioneers in Europe.

Dare to know: At DLD, renowned experts discussed the fundamental questions, problems, and opportunities currently affecting markets, media, culture and society in their transformation through the Internet and new digital business models. But lifestyle, design, music, and art are other important topics at Digital Life Design, because these areas are witnessing trend-setting changes visible to everyone. This year's DLD conference motto was "Dare to know." Artificial intelligence is changing the world, and is predicted to grow exponentially. Where the journey is headed – that's hard to say today.

"The same goes for every innovative idea", Alexander Gerfer adds. "That's why we specifically support start-ups in turning their ideas into marketable products – even if success is a long way down the road. Today, circuit designs can be developed much faster with AI support. It's important, however, that the components planned this way are also available in large quantities and in consistent quality. And that's why we're exactly the right partner, even in the AI era."

Lighting Development Kit 2.0

The all-in-one Lighting Development Kit [3] provides an easy solution to mix RGBW color for different lighting situations, amplify the growth of plants with the horticulture panel or even for indoor illumination based on Human Centric Lighting (HCL). The MagI³C Multi Color LED driver can power all three Panels. With four MagI³C LED Step Down High Current Modules (172946001) as its heart it is possible to control the intensity and color of each of the four LED strings individually to meet the applications needs. The controlling is done via an app for both iOS and Android, which is developed to control the reference design using Bluetooth® LE.

The board can be used for horticulture, mixing of different white color temperatures, mixing of RGBW LED combinations (red, green, blue, white) or just to change the intensity of one type of LED. The board includes an EMI filter in order to comply with the limits of the EN55015 conducted lighting standard and the CISPR32 standard for radiated EMI (tested with 1m output cable length) even while dimming the LED strings.



Lighting Development Kit – Version 2.0.

Features

- 4 Channel LED Driver
- Horticulture Panel to grow plants (16 LEDs)
- RGBW Panel for lighting solutions (4 LEDs)
- Sunshine Panel for indoor illumination (40 LEDs)
- Intensity of each channel can be adjusted individually (dimming 0 – 100 %)
- Dimming via Bluetooth® LE control (2608011024000)
- App "WEilluminate" to perform dimming
- PWM dimming method – controlled by PIC16F1527 microcontroller
- Dimming profiles and colors can be stored

- LED Driver: MagI³C Power Module 172 946 001
- Conducted and radiated EMI compliant (EN55015 & EN55032)
- Good thermal behavior
- Integrated robust industrial Bluetooth® LE module based on Nordic nRF52832
- The Kit is Bluetooth® LE 4.2 qualified. The QDID is 90212

Summary

Würth Elektronik's presence at the electronics trade show demonstrated its leadership in the electronics industry with a wide range of innovations and collaborative initiatives. The company highlighted its commitment to advancing technology with live demonstrations of its REDEXPERT and MyWE platforms, alongside practical offerings like free lab samples. Partnerships with IC manufacturers such as Infineon and Analog Devices further showcased Würth Elektronik's dedication to industry collaboration and high-quality reference designs.

The booth featured key product highlights, including the WL-ICLED series of RGB LEDs with integrated controllers, which enable precise color and brightness control for applications such as gaming and e-mobility displays. Display technologies like Mini-LED, μ LED, and ICLED were also central to the exhibition, emphasizing Würth Elektronik's ability to push the boundaries of resolution, efficiency, and interactivity. Innovations like the ICLED Color Calculator and solutions for high-power inductors and transformers solidified the company's focus on quality and functionality.

The Lighting Development Kit 2.0 rounded out the showcase, offering versatile lighting solutions for applications from horticulture to human-centric indoor illumination. This comprehensive display reaffirmed Würth Elektronik's role as a pioneer in the electronics sector. ■

References

- [1] <https://www.we-online.com>
- [2] <https://www.we-online.com/en/components/products/WL-ICLED>
- [3] https://www.we-online.com/en/components/products/LIGHTING_DEVELOPMENT_KIT

About the Würth Elektronik eiSos

Group: Würth Elektronik eiSos Group is a manufacturer of electronic and electromechanical components for the electronics industry and a technology company that spearheads pioneering electronic solutions. Würth Elektronik eiSos is one of the largest European manufacturers of passive components and is active in 50 countries. Production sites in Europe, Asia and North America supply a growing number of customers worldwide.



For more information visit:
www.we-online.com

Lighting and Sensing the Future: ams OSRAM's Breakthroughs in LEDs, Sensors, and Projection

LED Professional Editors

At electronica in Munich, Martin Wittmann, Senior Director Global Marketing, and Günter Hötzl, System Solution Engineer, showcased ams OSRAM's latest advancements in intelligent lighting and sensing technologies, highlighting the company's leadership in innovation and sustainability. These technologies introduced remarkable improvements in energy efficiency, enabling significant cost savings and enhanced performance for applications in horticulture, UV disinfection, and infrared sensing.

The focus was on sustainable solutions for diverse industries, including advanced lighting for controlled environments, efficient and eco-friendly disinfection systems, and highly precise sensors for robotics and smart devices. The showcased innovations emphasized adaptability, durability, and improved energy management, aligning with modern demands for smarter, greener technologies.

The event demonstrated how ams OSRAM's cutting-edge developments are driving sustainability while enabling greater precision and performance across industries such as agriculture, healthcare, and security. The presentations reinforced the company's commitment to shaping the future of intelligent lighting and sensing systems.

Breakthroughs

OSCONIQ® P 3737 – A Game-Changer in Horticultural Lighting

The OSCONIQ® P 3737¹ from ams OSRAM has left a significant impression in the horticulture industry as showcased in Munich. This high-power LED solution is redefining greenhouse and vertical farming efficiency by delivering cutting-edge performance with unparalleled energy savings and durability.

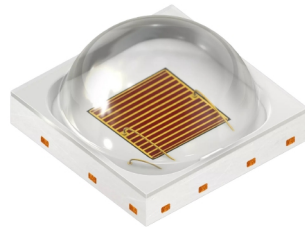

The OSCONIQ® P 3737 high-power LED achieves industry-leading wall plug efficiency of 83.2% in Hyper Red, enabling unique output levels and cost savings.

Energy Efficiency and Performance

The OSCONIQ® P 3737 stands out for its exceptional wall plug efficiency (WPE) of 83.2% in Hyper Red, enabling growers to achieve a photon flux of 6.13 $\mu\text{mol/s}$ while reducing energy consumption. This efficiency translates to tangible cost savings—up to 11% compared to prior LED generations—making it an economically and environmentally compelling choice for greenhouse operators. For instance, a greenhouse with annual electricity costs exceeding €100,000 could save €11,000 yearly, a notable return on investment.

¹<https://ams-osram.com/products/leds/color-leds/osram-osconiq-p-3737-2w-gf-pusra2-25>

Versatility Across Horticultural Applications

Available in five tailored colors (Hyper Red, Red, Deep Blue, Far Red, and Horti White), the OSCONIQ® P 3737 caters to various controlled-environment horticulture needs. It excels as a top light, interlighting solution, sole-source lighting, or in vertical farming setups, providing flexibility for diverse growing requirements. Its robust design ensures long-term reliability, maintaining 90% of its initial light output after an impressive 102,000 operating hours.

Demonstrations and Collaboration at electronica

ams OSRAM also highlighted the OSCONIQ® P 3737's practical applications through an innovative 4-channel Horticulture LED Module demo board. This module demonstrates the synergy between the OSCONIQ® LED family and advanced driver technology, offering greenhouse operators enhanced lighting control and efficiency. Inventronics' drivers, including their 1,800 W models with DALI-2 D4i compatibility, further expand the spectrum of lighting solutions by integrating digital interfaces for optimized power management.

Industry Leadership and Sustainability

ams OSRAM's presentation reinforced its status as a leader in horticultural LED innovation. By aligning top-tier performance with sustainable practices, the OSCONIQ® P 3737 exemplifies how advanced lighting technology can drive crop productivity while reducing operational costs. The OSCONIQ® P 3737 has set a new benchmark for horticultural lighting, offering unmatched efficiency, versatility, and longevity. Its debut demonstrated its transformative potential for greenhouse and vertical farming applications, cementing ams OSRAM's position as a pioneer in intelligent lighting solutions.

OSLON® UV 3535 – Pioneering UV-C Disinfection Technology

The unveiling of the OSLON® UV 3535² by ams OSRAM at recent industry showcases has cemented its status as a trailblazer in the UV-C disinfection market. This state-of-the-art UV-C LED is a game-changer, delivering mercury-free, efficient disinfection with cutting-edge technology and design innovations.

Exceptional Performance and Germicidal Efficiency

The OSLON® UV 3535 stands out for its impressive output of 115 milliwatts at the ideal germicidal wavelength of 265 nanometers. This wavelength is scientifically recognized as offering the highest germicidal effectiveness, ensuring unparalleled pathogen inactivation. The LED's advanced wall plug efficiency and robust design allow it to meet demanding performance criteria while maintaining a long operational life and competitive price-performance ratio.

²<https://ams-osram.com/products/leds/uv-c-leds/osram-oslon-uv-3535-su-culp1-vc>

Martin Wittmann summarized its impact: "This product sets a new industry benchmark by achieving peak efficiency at the most effective wavelength for disinfection while maintaining exceptional durability."

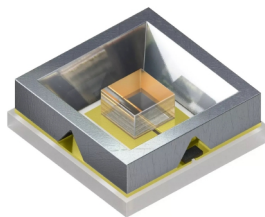

The new OSLON® UV 3535, a groundbreaking UV-C LED, serves the growing demand for mercury-free and efficient UV-C disinfection and treatment solutions.

Innovative Design for Diverse Applications

Engineered with versatility in mind, the OSLON® UV 3535 features a compact 3.5 mm x 3.5 mm footprint and a 120° emission angle, supporting a range of disinfection solutions. The LED leverages advanced AlGaIn-based flip-chip technology within an open ceramic package. This configuration, combined with a highly reflective frame, enhances light output and ensures forward-directed radiation.

The device's instant-on functionality and flexible design make it ideal for air, surface, and water disinfection. Its point-source feature reduces photon loss and maximizes efficiency, particularly in applications like UV-C LED reactors for water treatment or air purification devices.

Driving Innovation in the UV-C Market

The OSLON® UV 3535 represents a significant leap forward in UV-C LED technology, offering unique advantages over traditional mercury-based disinfection systems. Key benefits include:

- **Eco-Friendly and Safe:** Mercury-free technology aligns with global sustainability goals
- **Durability:** Extended lifetime and reliability in demanding environments
- **Instant Control:** On/off capabilities for responsive, on-demand disinfection
- **Compact Design:** Enables sleek, space-efficient solutions, that cannot be realized with lamps.

Studies, such as one conducted by the University of Liverpool, have confirmed that UV-C LEDs like the OSLON® UV 3535 achieve comparable disinfection perfor-



Martin Wittmann (left), Senior Director of Global Marketing, and Günter Hötzl (right), System Solution Engineer, both from ams OSRAM, provided an extensive tour of the ams OSRAM booth during electronica in Munich, showcasing breakthrough innovations in lighting to Siegfried Luger, Publisher of LED Professional.

mance to traditional mercury lamps while requiring significantly less UV-C radiation, enhancing system efficiency.

The OSOLON® UV 3535 encapsulates the future of UV-C disinfection, blending efficiency, flexibility, and eco-conscious design. By addressing critical needs across air, surface, and water treatment applications, it positions ams OSRAM as a leader in sustainable and innovative solutions for a rapidly evolving market.

TMF8806 – Redefining Precision in Time-of-Flight Sensing

ams OSRAM's TMF8806³, the latest addition to its direct Time-of-Flight (dToF) sensor lineup, has garnered widespread acclaim for its transformative potential in robotics and smart device applications. Designed for applications including obstacle detection and collision avoidance, this next-generation single-zone sensor combines precision, versatility, and energy efficiency in an impressively compact module.

Unmatched Performance and Versatility

Building on the success of ams OSRAM's dToF technology—already deployed in over 50 flagship smartphones and numerous autonomous systems—the TMF8806 elevates sensing capabilities with an extended detection range of 1 cm to 5 m. Its adaptability makes it ideal for home appliances, mobile robotics, smart cameras, security systems, and more.

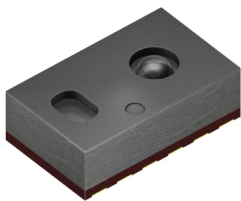

Ultra-low-power innovations, enhanced precision, and extended versatility: ams OSRAM unveils the TMF8806 direct Time-of-Flight (dToF) sensor module.

Günter Hötzl praised the sensor's capabilities: "This compact yet powerful sensor redefines precision and performance, offering unmatched accuracy for diverse applications."

³<https://ams-osram.com/products/sensor-solutions/direct-time-of-flight-sensors-dtof/ams-tm8806-1d-time-of-flight-sensor>

Key features include:

- **Enhanced Detection Range:** Standard mode operates up to 2.5 m, while long-range mode reaches 5 m
- **Energy Efficiency:** Ultra-low-power design, consuming just 0.26 µA in shutdown mode
- **Wide Compatibility:** Supports I/Os ranging from 1.2 V to 3.3 V, making it suitable for various hardware configurations
- **Compact Form Factor:** At only 3.6 x 2.2 x 1.0 mm, it integrates seamlessly into space-constrained devices

Precision in Every Environment

The TMF8806 uses dToF technology to capture distance measurements by timing ultra-short light pulses, ensuring rapid, accurate data with minimal interference from environmental reflections. Its 24° Field of View (FoV) and wide operating temperature range (-40°C to 85°C) make it a reliable choice for challenging conditions. The sensor's advanced statistical processing eliminates inaccuracies, guaranteeing consistently high precision across applications.

Developer-Friendly Design

ams OSRAM has prioritized ease of use, offering a suite of tools to simplify development and integration. Key resources include:

- **Hardware Support:** The TMF8806-Shield Board, Arduino® Uno R3 platform, and breakaway sensor board facilitate fast prototyping and testing
- **Plug-and-Play Functionality:** Pre-installed firmware ensures instant operation without additional downloads
- **Universal GUI and Python Scripts:** These tools support logging, calibration, and visualization, streamlining the development process
- **Open-Source Resources:** ams OSRAM's GitHub repository provides drivers and software examples to kickstart projects

Innovation in Collision Avoidance and Automation

The TMF8806 sensor's precise and efficient design is a game-changer for robotics and smart devices, enabling advanced features like autofocus, virtual barriers, and inventory management. Its flexibility in adjusting to different optical stacks and glass thicknesses further enhances customization for specific applications.

The TMF8806 sets a new benchmark for single-zone dToF sensors, combining exceptional performance, low-power operation, and developer-friendly tools in a compact package. By addressing the needs of modern robotics and automation sys-

tems, ams OSRAM has positioned itself as a leader in intelligent sensing technology, paving the way for smarter and more efficient devices across industries.

IR:6 – Next-Generation Infrared LED Technology

ams OSRAM's launch of the IR:6 infrared LED chip technology⁴ has redefined the standard for brightness and efficiency in infrared lighting. With a remarkable increase of up to 35% in brightness and 42% in efficiency compared to previous models, the IR:6 technology has captured attention across various industries, from security systems to medical devices.

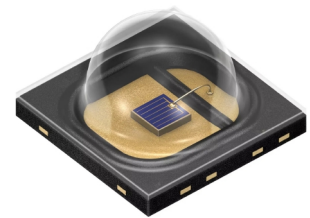

IR LED product versions based on the new IR:6 technology to boost performance in security and biometrics applications.

Unparalleled Performance and Versatility

The IR:6 thin-film chip technology enables superior performance across diverse applications. For manufacturers of security cameras, biometric authentication systems, and smart doorbells, the enhanced brightness and efficiency translate to improved image quality and faster, more accurate recognition of biometric markers. These advancements also result in lower power consumption and extended battery life, aligning with sustainability goals.

In medical applications such as light therapy for tissue damage treatment, the increased optical power of the IR:6 allows manufacturers to use fewer LEDs while achieving the same therapeutic effects. This saves space and reduces overall costs, making the technology particularly attractive in cost-sensitive and compact designs.

New Products Leveraging IR:6 Technology

The first products to feature the IR:6 chip include the OSOLON® P1616 series and the OSOLON® Black family, offering a range of options tailored to specific needs:

⁴<https://ams-osram.com/news/press-releases/ams-osram-introduces-ir-led-product-versions-based-on-the-new-ir-6-technology>

- OSLON® P1616 Series:
 - Compact 1.6 mm x 1.6 mm package
 - Radiant flux up to 1650 mW with various wavelength and viewing angle options
 - Ideal for space-constrained applications in security and biometrics
- OSLON® Black Family:
 - Features a rectangular field of illumination, perfect for IR cameras
 - Wavelengths of 850 nm and 940 nm for diverse use cases
 - Radiant flux up to 980 mW with options for varying viewing angles, enhancing design flexibility

Advanced Technology and Design Improvements

The IR:6 chip incorporates innovative material and structural improvements that deliver superior performance:

- Higher Chip Efficiency: Enhanced intrinsic efficiency improves overall brightness
- Central Bond Pad: Optimizes current spreading and reduces forward voltage
- Improved Surface Roughening: Increases decoupling efficiency and brightness
- New Wavelength Options: Adds a 920 nm wavelength, offering a better signal-to-noise ratio and reduced visible red glow compared to traditional 850 nm or 940nm wavelengths

These advancements cater to applications requiring precision and power, including autonomous devices, inventory systems, and light therapy equipment.

Quality and Reliability

Manufactured in Regensburg, Germany, the IR:6 chip benefits from a fully controlled supply chain, ensuring consistent quality and high-volume availability. This end-to-end control reinforces customer confidence in the reliability and performance of ams OSRAM products.

Industry Impact

Martin Wittmann highlighted the transformative impact of IR:6: “The new, improved IR:6 technology from ams OSRAM is setting once again an industry benchmark in the market segment for both, brightness and efficiency. Customers that replace their existing IR LEDs with new IR:6-based LEDs can instantly achieve better performance in their application with lower power consumption.”

The IR:6 infrared LED technology represents a significant leap forward in infrared sensing and illumination. Its combination of brightness, efficiency, and versatility positions it as a critical enabler for next-

generation devices across a range of industries. With its robust product offerings and customer-centric design, ams OSRAM continues to lead in innovative solutions for a brighter, more efficient future.

EVIYOS® Shape

In this field, ams OSRAM presented a new, intelligent project at electronica 2024: EVIYOS® Shape, a product based on EVIYOS® technology, is now being used for the first time in applications outside the automotive sector.



The EVIYOS® Shape, developed by ams OSRAM, is a disruptive LED technology featuring a monolithic chip with 25,600 micro-LEDs, each controllable with a 40 µm pixel pitch.

EVIYOS® Shape is a cutting-edge, µLED-based light source designed for architecture, entertainment and machine vision applications, as well as for urban projection scenarios creating new visions for smart cities. As a first joint customer project, the ams OSRAM partner ELEPN showcased the brand-new MLP300 at the 25th China International Optoelectronic Exposition (CIOE). This micro-LED smart projector was developed by ELEPN, a provider of micro projection modules, and will also be enriched with the groundbreaking LED innovation EVIYOS® Shape from ams OSRAM.

“EVIYOS® Shape ensures precise control and real-time adaptability, making it perfect for transforming urban environments with customizable light scenarios”, said Günter Hötzl.

The LED was launched on the market at the beginning of 2025.

microLEDs

ams OSRAM has refocused its development activities in the microLED sector, prioritizing projection technologies, particularly for automotive applications. While other application areas may become viable in the future, these are considered optional possibilities, as leading market research firms like TrendForce also suggest.

Summary

At electronica in Munich, ams OSRAM demonstrated its continued leadership in intelligent lighting and sensing technologies through groundbreaking advancements across various fields. Presentations highlighted energy-efficient solutions for horticultural applications, eco-friendly innovations for UV disinfection, and high-performance infrared and time-of-flight sensing technologies. These developments showcased significant improvements in energy savings, operational efficiency, and precision, addressing the evolving needs of industries such as agriculture, healthcare, robotics, and security.

ams OSRAM's focus on sustainability and adaptability was evident in its versatile product applications, from greenhouse lighting to autonomous systems and medical devices. The event reinforced the company's commitment to driving technological progress while meeting global sustainability goals. By integrating cutting-edge technology with practical industry solutions, ams OSRAM is shaping a smarter and more sustainable future across diverse markets. The showcased innovations at electronica underscored the company's pivotal role in transforming modern lighting and sensing systems. ■

For more information visit the following websites: ams-osram.com



Optimizing Lighting Energy Efficiency (Part II) – Consideration of Behavioral Aspects in Lighting Systems

Dipl.-Ing. Johannes WENINGER^{1,3}, Team Leader Research at Bartenbach, and Dr. techn. Sascha HAMMES², M.Sc., Researcher at University of Innsbruck

Insufficient information about user-related parameters within the building design phase is currently bridged by employing empirically proven and standardized occupant models, which are formulated as generally as possible to achieve a high degree of applicability. However, such generalized models cannot adequately reflect individual and dynamic occupancies or the diverse human interactions with building systems. This often results in energy-inefficient operation of lighting systems and is reflected in performance gaps between planning and operation. As the user-related influences only become apparent after commissioning, appropriate concepts are required to improve energy efficiency.

While the first part focused on identifying the factors influencing energy consumption, the second part of this series presents strategies that consider the identified user-related influencing factors in lighting control to improve energy efficiency. The concepts presented are based on long-term data collection from an open-plan office at Bartenbach GmbH, which is operated as a Living Lab since 2019. The results show that significant improvements can subsequently be achieved through greater user-centricity. However, user-centeredness starts with the lighting concept.

Introduction

The influence of occupancy behavior on energy demand in buildings is well known [1] and was highlighted in the first part of this article [2]. It was also emphasized that strong user-related dynamics can occur in buildings, e.g., regarding occupancy behavior at the workplace and the interaction of occupants with building systems. These are the result of contextual factors such as widely varying work processes, employment levels, degrees of freedom in the social structure, age and gender [3]. In addition, these influences prove to be variable over time in most cases. A study from 2014, for example, analyzed 23 months of occupancy sensor data from a large office building to establish occupancy diversity factors and investigate their influence on energy simulation models. The results show that occupancy diversity factors vary significantly with days of the week and sea-

sons [4]. Furthermore, it can be assumed that occupancy behavior varies considerably between organizations.

As user behavior only emerges after commissioning, it is generally difficult to adequately predict occupancy in the planning phase. To overcome uncertainties in this respect when planning lighting systems and associated control systems, assumptions about occupancy behavior are usually made that are as generally valid as possible to achieve a high level of applicability. This includes, for example, the normative workplace lighting of 500 lx in accordance with EN12464-1. Design concepts for lighting control systems that are based solely on these generally applicable specifications usually consider neither the individual lighting preferences of the individual users nor the occupancy patterns at the workplace. This can have a negative impact on both comfort and energy requirements [5,6] and is usually expressed in unwanted user interventions in the planned control system, particularly by overriding intended control curves in automated systems [7,8]. The resulting negative effects can be particularly pronounced in applications with diffuse areas of responsibility, for example in open-plan offices with room-based lighting concepts [9]. It is therefore hardly surprising that most of the currently available building management systems are hardly suitable for user-orientated requirements. It therefore requires user-centered lighting systems and concepts that have the ability to adequately consider real presence patterns, as the degree to which user-related

“Optimizing Lighting Energy Efficiency” (Part I) was published in issue LpR#106, Nov/Dec 2024.

¹ Bartenbach GmbH, Lindenstraße 1, 6112 Wattens / Tirol, Austria

² University of Innsbruck, Unit of Energy Efficient Building, 6020 Innsbruck / Tirol, Austria

³ Johannes.Weninger@bartenbach.com

parameters are accounted for significantly determines whether key performance indicators (KPIs) for lighting are achieved or not.

In the context of lighting control, an extensive online market survey on the topics of BIM and lighting controls was conducted in the summer of 2023 with participants from the manufacturing industry, contractors, (lighting) design, research and development, building owners and facility management (see [10]). A total of 165 usable responses were received (272 in total, 133 complete). Based on the communication channels used, the focus was on participants from Europe (87.8%). The respondents' assessment reflects the current situation well, namely that aspects of user-centeredness are currently only barely reflected in available building systems (Figure 1). The participant groups of building owners and contractors did not provide enough feedback for an evaluation.

Most survey participants named zonal systems as the most frequently used solution in the context of user-centered lighting, i.e., the division of the lighting system into separately controllable sections, which represents a first step away from room-centered lighting concepts (Figure 2). The positive effects of zoned workplace lighting on energy consumption were also highlighted in 2020 in a study carried out in the Living Lab [11,12]. It was shown that the higher the degree of zoning, the lower the energy requirement, as energy is only consumed where it is needed (Figure 3). More importantly, however, zoning has a positive effect on visual comfort and system acceptance, as individual lighting preferences can be better reflected. At the same time, the risk of conflicts between different lighting preferences is reduced [9]. Zoned lighting systems therefore prove to be promising for energy efficiency and comfort, especially since they are easy to implement in the planning phase.

The second most frequently chosen option in the survey was manual override (Figure 2). Even if automated systems are more energy-efficient than manual lighting control systems [13,14], the option of manual override is always beneficial to maintain user acceptance of the system [15]. However, it must be noted that this simultaneously enables potentially negative energetic effects, which are primarily caused by an inadequate predefinition of automation mechanisms, as users increasingly intervene in the system control and thus counteract overarching control objectives.

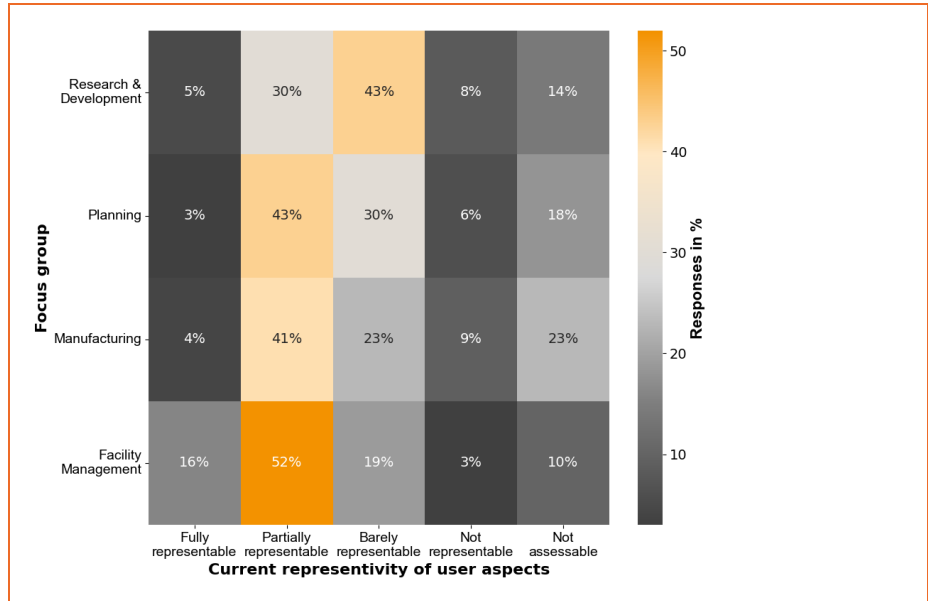

Figure 1: Market survey responses to the question of how well user aspects are currently considered in building systems (type of question: Likert scale) - Image adapted from [10].

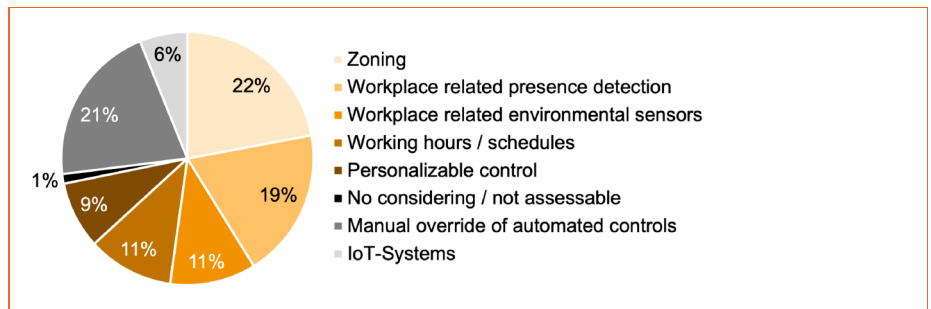

Figure 2: Answers from the market survey for the planning focus group to the question of which user-centered concepts are currently being implemented (type of question: multiple choice, relevance in % of total number of valid responses) - Image adapted from [10].

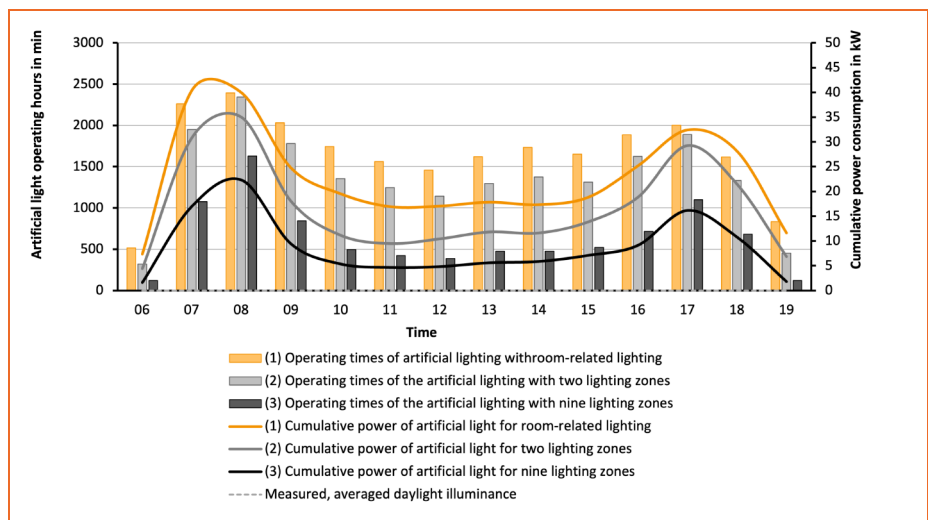

Figure 3: Comparison of the cumulative energy demand and the artificial lighting operating times for different lighting zones over the course of the day (study period Sep. 2020 to Nov. 2020, study object: open-plan office of the Bartenbach R&D building in Aldrans, Austria) - Image adapted from [12].

Presence-based lighting control is emphasized as the third most frequently chosen option (Figure 2). This promises energy savings of around 30% compared to manual control [16,17]. While camera-based systems only reveal their added value in applications that go beyond simple presence detection, passive infrared sensors are the preferred solution for presence control, particularly due to their simple installation and low costs [18]. However, this detection technology is associated with switch-off times to avoid disruptive false-off rates due to incorrect absence detections during inactive stationary activities. There are also generalized specifications for the switch-off time to ensure a high level of applicability. For example, the recommended industry standard for passive infrared sensors is in the range of 10 to 20 minutes depending on the room type [19]. Since individual occupancy patterns are generally not taken into account, there is still considerable potential for further savings, as this article will show later.

Finally, the survey identified the collection of individual environmental parameters at the workplace as a frequently used user-centered measure (Figure 2). However, to assess the actual situation, energy and indoor climate data are currently primarily collected and made available to facility management as a representative instance in building operations (Figure 4). At 6%, occupancy is barely used [10], although it is a crucial information to derive measures to improve building operation. The subsequent application of evaluation routines after commissioning to achieve improvements in energy efficiency and comfort is therefore currently significantly limited by the lack of both real-time and historical data.

Description of the Living Lab

The Bartenbach R&D building in Aldrans has been operating as a Living Lab since 2019. The implemented workflow enables gathering relevant operational data, identify improvement measures, implement them through a dynamically expandable control system, and evaluate their effectiveness. Monitoring the success of implemented systems is a crucial step that is often overlooked in practice. However, it can uncover significant potential for further improvement.

To record the real situation, the open-plan office (160 m²) was equipped with several sensors (Figure 5). Presence is detected both at individual workstation level and at

the level of a lighting zone using passive infrared sensors. To ensure the best possible utilization of presence information, the detection range of the sensors was limited to the respective target area. This not only allows energy-efficient control of the artificial light depending on presence, but also the derivation of workplace-related occupancy profiles. To utilize the benefits of zoning, the open-plan office designed as a Living Lab is divided into nine separately controllable zones (Figure 6), which can accommodate 18 people regularly (2 people per zone) and 28 people maximum.

The five workstation zones on the south façade are designed for a maximum of four workstations each (Figure 6). The artificial lighting and daylight system can be controlled individually for each workstation zone.

Recording the illuminance per workplace zone can not only be used to regulate the individual lighting zone to the target illuminance (e.g., 500lx) and evaluate the daylight input in order to increase energy efficiency, but can also be offset against the occupancy at the workplace in combi-

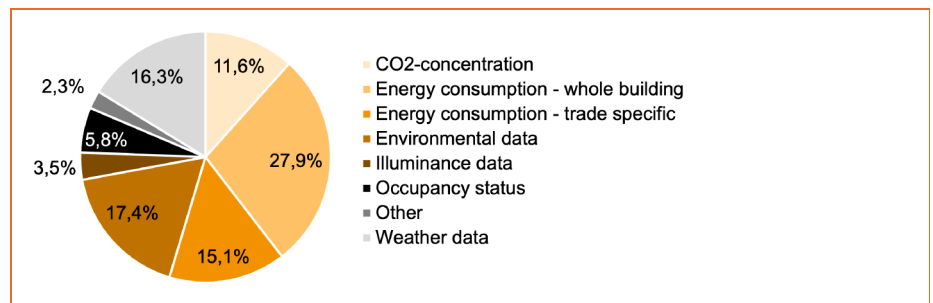

Figure 4: Answers from the market survey for the facility management focus group to the question of what data is available (type of question: multiple choice, relevance in % of total number of valid responses) - Image adapted from [10].

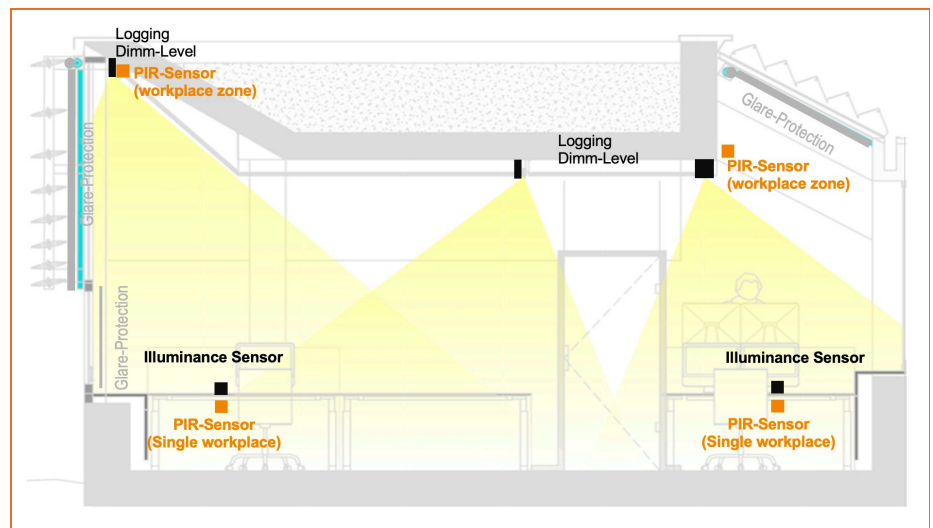

Figure 5: Overview of the positioning of lighting-relevant sensors in the building section.

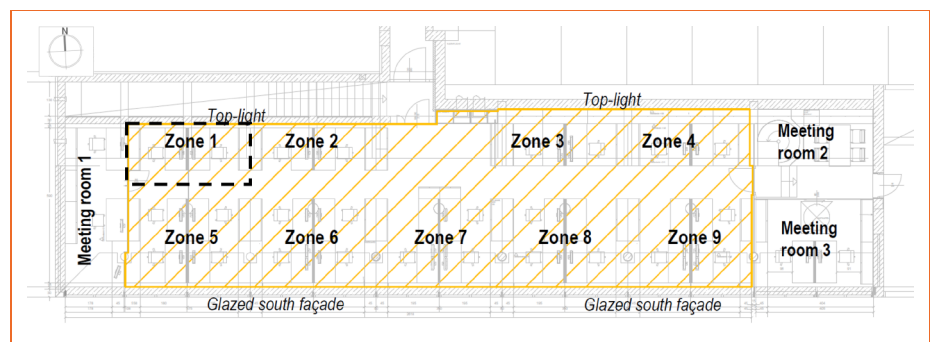

Figure 6: Floor plan of the Bartenbach Living Lab with nine separately controllable lighting zones.

nation with the dimming level of the artificial light or the energy requirement of the artificial light in order to generate energy-weighted occupancy profiles. When evaluating zones with several people, the logical-or linked occupancy profile is used.

Furthermore, the energy consumption of the actuators, window openings and the indoor climate as well as the outdoor situation are comprehensively recorded and stored in the study object. All recorded values are either logged at minute level or for status changes. A programmable logic controller serves both as the central building control system and for logging the sensor data and actuator statuses. All user-related information is processed in compliance with data protection regulations.

As highlighted at the beginning, occupancy behavior is shaped by socio-cultural factors and work processes. The work of the employees in the Living Lab corresponds to that of a project manager, which also means more meetings. There is also the possibility of flexible working hours between 6:00 and 20:00 with core working hours in the building from Monday to Friday from 9:00 to 12:00, as well as home office.

Further details on the study object can be found in the previous article of this two-part series [2].

Strategies for Reducing Energy Consumption

The positive effect of zoning the lighting system on energy requirements and user satisfaction was emphasized at the beginning of this article (see also [11]). In addition, the zoning of lighting represents a key starting point for further improvement measures, which essentially aim to collect individual occupancy profiles and make them applicable in control systems to increase energy efficiency. Some of them have been systematically analyzed in the Living Lab in recent years and evaluated with regard to their effectiveness.

Adaptation of the Switch-off Time to Real Occupancy Patterns

Due to the organizational framework conditions such as flextime regulations and home office as well as the daily work routine of the employees in the study object, which is characterized by meetings, a strong dynamic can be recorded via

the attendance at individual workstations recorded by the passive infrared sensors (Figure 5). The individuality of the behavior patterns can be clearly illustrated by a direct comparison of the individual zones (Figure 7). The more intense the orange color, the higher the probability of being present at the workplace. Dark gray areas, on the other hand, indicate a low probability of being present or no presence in the respective zone (Figure 7).

In 2020, a study [6] was conducted that used these inter-individual differences for a user-centered adaptation of the currently generalized switch-off times and evaluated the resulting effects in terms of user acceptance and energy efficiency. In the study, the relative frequencies of the periods of inactivity for each workplace zone were determined based on the recorded occu-

pancy times of the users at the workplace. Based on this, the cumulative probabilities of the minimum periods of absence were derived (Figure 8). Considering the distribution of the periods of inactivity, it was possible to determine the point in time at which a permanent absence is more likely than a return of the person to the respective workplace zone. By applying this method, the switch-off times could not only be individually adapted to the respective behavior patterns in the individual zones, but also significantly reduced compared to the industry standard of 15 minutes (e.g. to 4 minutes in Zone 7, see Figure 8). In order to create smooth transitions between the artificial light circuits and thus make switching off less disruptive for neighboring occupied lighting zones [20], the individual switch-off times were initiated differently

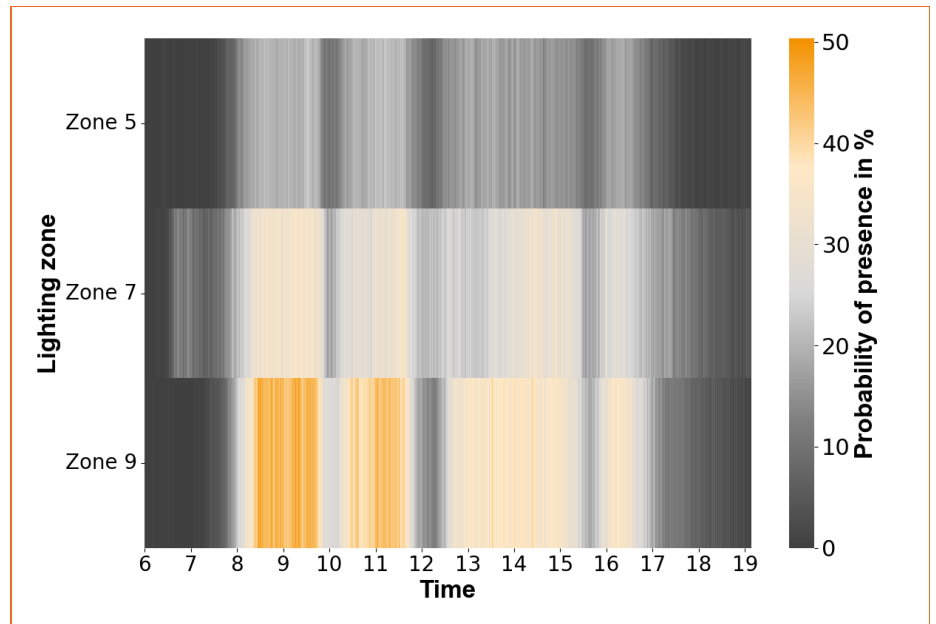

Figure 7: Occupancy dynamics using the example of three zones from the study object, without switch-off time, data period: Jan. 2022 to Jul. 2024.

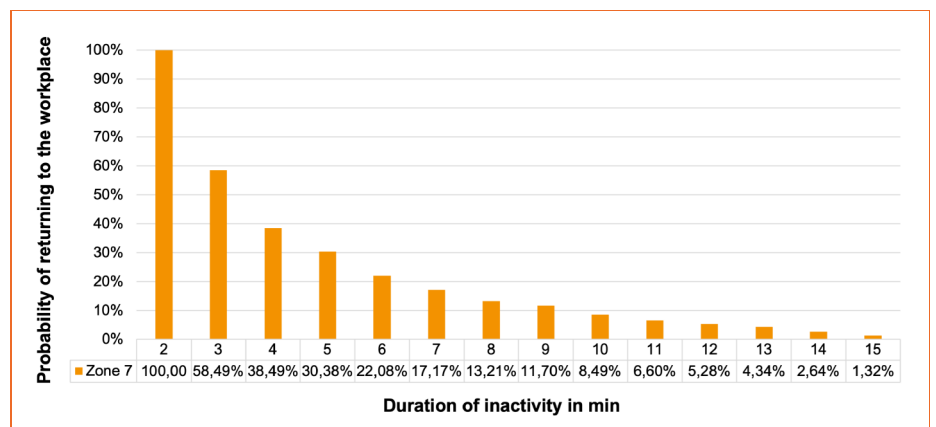

Figure 8: Cumulative relative probability of minimum absence duration – Image adapted from [6].

using dimming procedures, which were based on the underlying probabilities.

The reduced switch-off times implemented for the period Sep. 2020 to Nov. 2020 in the Living Lab. Acceptance was assessed before and after implementation of the reduced switch-off times by means of a survey. A consistently high level of system acceptance was demonstrated. In addition, the higher sensor resolution of the sensors at the individual workstation proved to be decisive for reducing the false off rates. The energy evaluation for the period showed a reduction in the artificial lighting energy requirement of approx. 17% from 121.6 kWh to 100.4 kWh in the period under review (Figure 9). It should be noted that the energy requirement for artificial lighting in the building is limited to the

morning and evening hours due to the high level of daylight autonomy. However, these time periods are also typically subject to increased occupancy dynamics. As a result, there is a potentially increased call-up of the switch-off time in the study building, which means that the savings achieved cannot be generalized.

The advantage of the method used, however, is that derived switch-off times are automatically adjusted when behavior changes. A study conducted in 2024 [21] concluded, that switch-off times can be subject to temporal variability (Figure 10), by segmenting the occupancy times at the workplace into contiguous time series of similar occupancy patterns over the Hamming distance (tolerance level of one third). Comparing the individual segments, the

results showed significant changes in the switch-off time within a zone (Wilcoxon signed-rank test, $p < .05$). However, since the adjustments in the method used were always made retrospectively and not predictively, the follow-up study compared various machine learning-based modeling approaches that use historical data from the Living Lab to determine recommendations for the length of the switch-off time for future periods. The results showed that ML methods may offer a sufficiently high level of accuracy for the application [21]. K-Nearest Neighbor Regression performs best in terms of energy requirements and computing time. On average, the coefficient of determination R^2 for the best models is in the range of 0.77 ± 0.03 . Validation of the applicability by means of an implementation in the control system of the Living Lab is currently still pending.

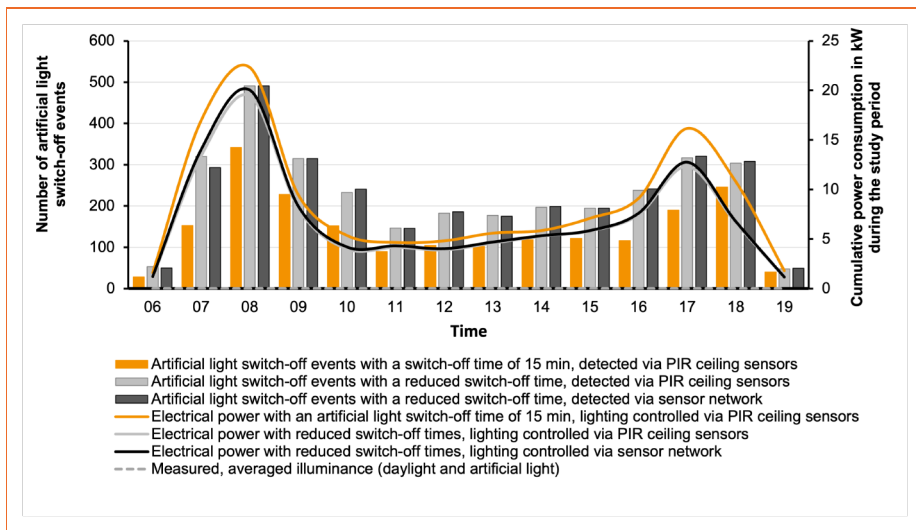

Figure 9: Cumulative relative probability of minimum absence duration – Image adapted from [6].

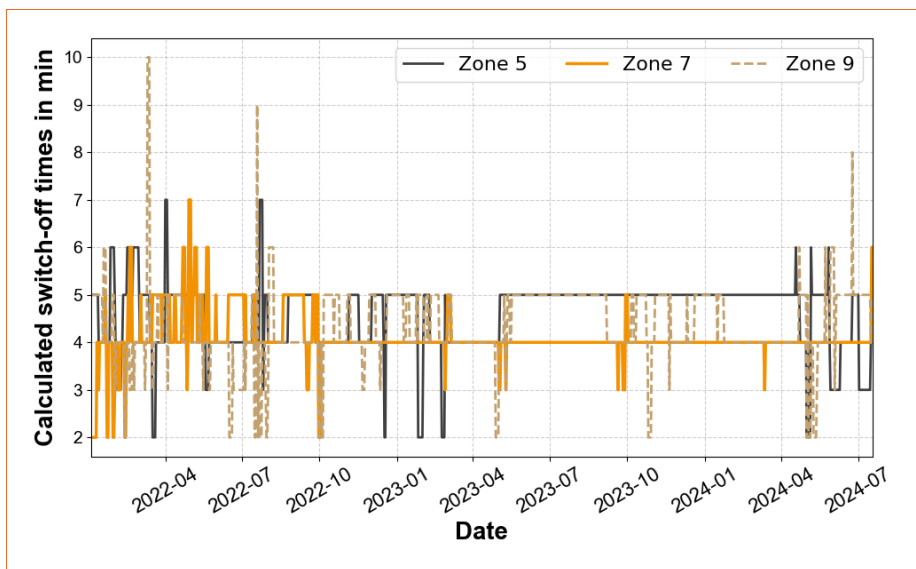

Figure 10: Exemplary illustration for the variation of switch-off times for three lighting zones from the open-plan office, occupancy times segmented via Hamming distance and derived using the methodology from [6], based on the measurement period Jan. 2022 to Jul. 2024 – Image adapted from [21].

While user-centered control approaches prove to be promising for reducing energy demand, they simultaneously present challenges, particularly in planning processes. As the reliance on real-time decisions to achieve lighting-related KPIs cannot be adequately reflected in current simulation assumptions, this would exacerbate the existing performance gap. From this perspective, not only are general improvements in the operational energy efficiency of systems essential, but also advancements in their simulation capabilities. These are indispensable for effectively and sustainably transferring energy-positive potentials into practical applications in the long term.

Derivation of Behavior-informed Simulation Assumptions

Since the individual zones of the Living Lab are used by several employees at the same time, the artificial lighting energy requirement of each lighting zone results from a logical OR linking of the occupancy patterns assigned to this lighting zone. Based on the highlighted importance of considering both the individual occupancy patterns and the spatial variation of daylight, a time-resolved artificial lighting energy profile can be created for each user combination. Theoretically, user distributions in the room can be derived from the recorded presence profiles at the individual workstations and the information on the artificial lighting supplement required to achieve the target illuminance, which result in minimum or maximum energy consumption. The resulting range constitutes the potential error range of general simulation assumptions. However, depending

on the number of people, this can quickly become a combinatorial problem, which proves to be NP complete and therefore cannot be computed in finite time. For this reason, preliminary studies were carried out to implement suitable methods that make it possible to derive user distributions in the room and thus subsequently derive a potential error in the predicted energy consumption. The results of the preliminary studies were already highlighted in the first part of this article in the description of the influence of occupancy behavior on energy demand [2].

One of the previous studies relied on a combination of Hungarian and Blossom algorithms to derive such an energy-optimized user distribution in the room (see details in [22]). Based on a data collection from the period Jul. 2021 to Nov. 2021, the resulting span of approx. 83% from the best-case to the worst-case scenario. The minimum energy requirement was reduced by approximately 30% compared to the original user distribution in the room. Further, the results also showed, that the influence of room positioning becomes much more significant with better user matching (Figure 11), indicating an intrinsic connection between the efficiency of individual user pairings and their spatial distribution. However, the method proves to be unsuitable for deriving the relevant error from simulation assumptions, since it can only derive minima and maxima, whereas the errors arise based on the distributions of the deviations of all user pairings.

To correct this limitation, another study was conducted in 2024, using an approach based on creating sufficiently large samples using Monte Carlo simulation [23]. Over 10.24 million randomized variations of user pairings were generated using high-performance computing (HPC) in 60,000 core hours, based on a data set of occupancy and lighting data from Feb. 2022 to Jan. 2023 from the Living Lab presented. The calculation was realized via several parallel batches, which were implemented on a total of 128 CPU cores from the VSC-5 of the Vienna Scientific Cluster (Austrian National Supercomputing Centre). Here, too, user distributions in the room were identified that estimate a significantly lower energy requirement than the initial situation. For the study period from Feb. 2022 to Jan. 2023, the study [23] shows that the best user distribution in terms of energy in the variations generated via HPC has an artificial light energy requirement of 182.8 kWh. In comparison, the algorithm from [22] would lead to an energy demand of 178.3 kWh, around 2.5% better than the HPC variant. The initial distribution to people leads to an energy requirement of 237.32 kWh.

While both approaches are fundamentally well-suited for deriving improved error estimations from current simulation assumptions, they are still subject to a significant limitation that restricts their application in real-world scenarios. These methods are typically only applicable retrospectively, as they are highly data intensive. This means

that, in most cases, the necessary data is not available at the time when energy simulations are conducted, as user behavior can only be observed after occupancy begins. Therefore, a meaningful improvement of current simulations and a reduction in related errors require methods based on model assumptions that utilize widely available data sources for modeling.

A study published in 2024 [24] introduced a potentially effective method aimed at modeling user behavior on an individual level. The approach utilized Support Vector Regression (SVR) with a Radial Basis Function (RBF) kernel and relied solely on high-level data streams derived from information about work behavior. Data from the Living Lab, collected between July and November 2021, were used for modeling. These included actual attendance records, time-stamping data, and planned absences extracted from Outlook calendars.

Attendance was probabilistically modeled in 10-minute intervals, then averaged on an hourly basis and compared to the accuracy of current simulation assumptions. The results demonstrated a mean absolute error of 5.01% in predictions—a significant improvement over existing assumptions, where errors for the same period ranged between 25% and 30%. The highest modeling error occurred between 12:00 and 1:00 PM, a time frame that can be considered negligible for energy analyses due to the high availability of daylight.

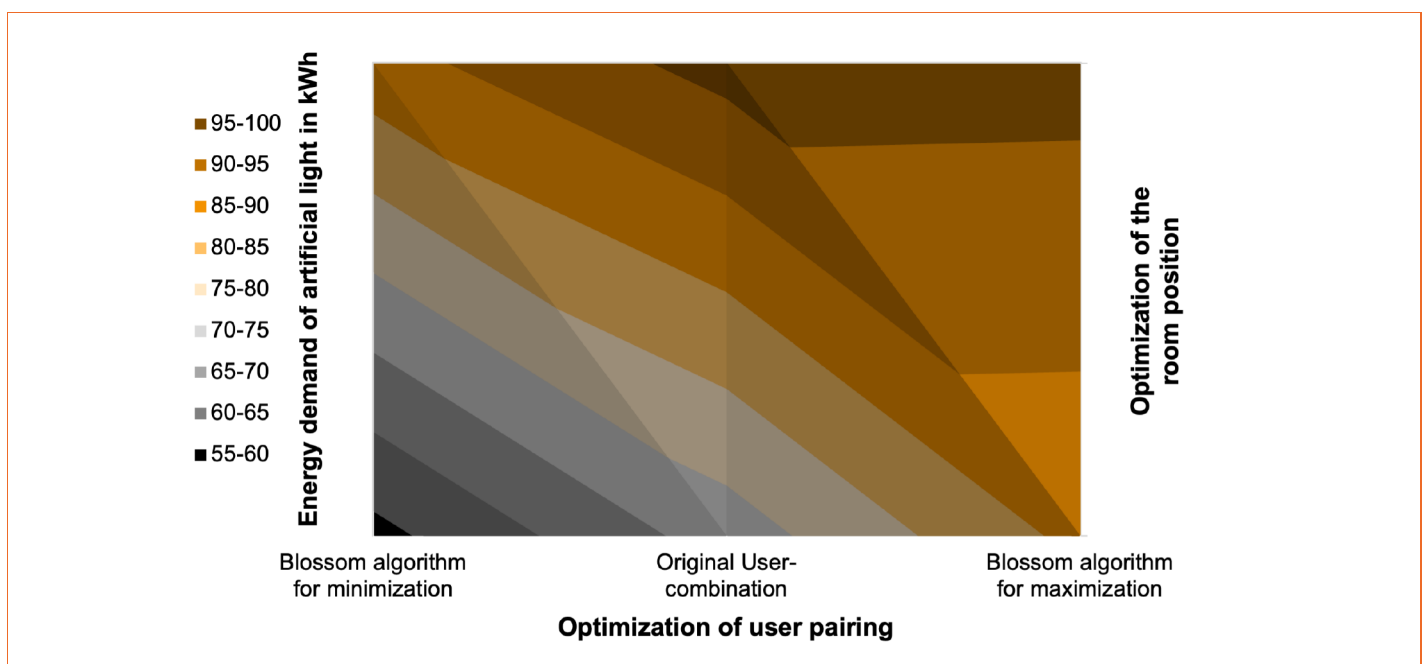

Figure 11: Influence of the individual optimization steps on the artificial lighting energy requirement, data basis: R&D office of Bartenbach GmbH, Jul. 2021 to Nov. 2021—Image adapted from [22].

Discussion

The results clearly demonstrate that the use of behavioral information in artificial lighting control systems can significantly improve energy efficiency. This is particularly important because current limitations in predicting the energy performance of lighting systems lead to misconceptions during planning processes, which inevitably contribute to suboptimal implementations. Since facility management typically has limited opportunities to intervene in control systems and often lacks adequate data [10], manual adjustments after commissioning are generally too cost- and resource-intensive to justify compared to potential energy savings. As a result, sub-optimal system implementations are often tolerated. Dynamically adaptable control systems, therefore, show significant potential to overcome these existing limitations.

Additionally, dynamically adaptable controls, combined with the collection of data on user behavior and energy consumption, form the basis for leveraging many approaches currently being researched in the scientific field, especially the application of machine learning algorithms. The potential lies not only in improving energy efficiency but also in effectively addressing comfort parameters. However, such implementations require sufficient data quality. Wireless sensor networks can serve as a useful tool in this context, offering the advantage of lower installation costs due to the elimination of cabling. They also provide high flexibility in sensor placement [25,26], which, along with the number and coverage range of sensors, significantly influences quality [6,27]. However, it is important to note that the energy required for the production, operation, and disposal of sensors must be weighed against the potential energy savings, and the necessary number of sensors increases with greater zoning.

Nevertheless, zoned concepts prove to be a fundamental requirement for addressing existing potentials in a targeted manner. The results of this two-part series suggest that the energy benefits generally outweigh the required sensor deployment. Moreover, zoned concepts often lead to increased acceptance among end users, as individual comfort requirements can be better addressed. However, while zoning is not fundamentally seen as a planning challenge, it plays a significant role in the development of performance gaps because current simulation assumptions do not differentiate between zones, e.g. all zones are based on the same behavioral assumptions. Improving understanding in this area, along

with user models and their implementation in simulation procedures, is therefore a basic requirement for achieving long-term energy benefits in real-world applications.

Limitations

The results of the studies presented show that energy consumption can be significantly reduced by better reflecting individual occupancy behavior. However, the building analyzed benefits from above-average daylight autonomy (DA=81.56%, cf. [2]), which means that artificial lighting is often not required during the day. As the occupancy pattern can differ significantly from organization to organization and the availability of daylight varies from building to building, there may be greater fluctuations in terms of energy savings. Further studies under different organizational conditions and for other building types are therefore necessary to make general statements. For example, the artificial lighting energy demand in the study object is primarily limited to the morning and evening hours, which are strongly influenced by variable occupancy times. The influence of occupancy behavior could therefore be overestimated, which could only be clarified by comparative studies, which are currently lacking.

Conclusion

Since not all information about subsequent building use is typically available in the early planning phases, incorrect or insufficiently precise planning assumptions can lead to inefficient lighting system operation and energy performance gaps. Monitoring and analyzing operational data through post-occupancy evaluations can serve as a basis for analyzing occupancy behavior and initiating appropriate measures, such as the methods presented, to improve energy consumption. Directly integrating these procedures into control systems would help avoid unnecessary costs associated with manual analyses while ensuring that control processes adapt to changing environmental and usage conditions. At the same time, the collected data is invaluable for achieving a better understanding of system usage. The theoretical usage patterns derived from such analyses could significantly improve current simulation accuracy over the long term, helping to close energy performance gaps sustainably.

However, many questions still need to be answered from today's perspective. Future studies should focus on whether there are seasonal effects on occupancy behavior and how these influence the proposed

algorithms. Furthermore, the impact of sociocultural and organization-specific factors must be further broken down and quantified to enable better predictions. The increased use of machine learning in building technology also requires closer investigation in future studies to simplify time-intensive analyses of real-world data and account for the temporal dynamics of occupancy behavior. At the same time, it is essential to critically evaluate existing limitations in this field, particularly regarding inaccuracies, as these could significantly affect user acceptance.

While the first part of this two-part article series focused on studies highlighting the current issues of user-related uncertainties in planning and their impact on predicting the energy demand of artificial lighting systems along with identifying and quantifying key factors, the second part addresses methods for retrospectively improving energy efficiency by leveraging behavioral information at various levels. Such measures are becoming increasingly important in light of current energy policy goals and the fact that lighting accounts for a significant share of a building's energy demand. Consequently, these methods should continue to receive adequate attention in the research and development of lighting systems to contribute positively to current societal challenges. ■

Acknowledgments

The presented study results were partially funded by the Austrian Research Promotion Agency (FFG) as part of several framework programs and research projects.

Bartenbach [®]

**universität
innsbruck**

References

[1] Yoshino, H., Hong, T. & Nord, N. (2017). IEA EBC annex 53: Total energy use in buildings—Analysis and evaluation methods. *Energy and Buildings*, 152, 124-136.

[2] Weninger, J. & Hammes, S. (2024). Optimizing Lighting Energy Efficiency (Part I) – Behavioral Aspects of Energy Consumption. *LED Professional Review*, 106, 36-42. Dornbirn: Luger Research e.U.

[3] D'Oca, S., Pisello, A. L., De Simone, M., Barthelmes, V. M., Hong, T. & Cognati, S. P. (2018). Human-building interaction at work: Findings from an interdisciplinary cross-country survey in Italy. *Building and Environment*, 132, 147-159.

[4] Duarte, C., Van Den Wymelenberg, K. & Rieger, C. (2013). Revealing occupancy patterns in an office building through the use of occupancy sensor data. *Energy and buildings*, 67, 587-595.

[5] Hammes, S., Hauer, M., Geisler-Moroder, D., Weninger, J., Pfluger, R. & Pohl, W. (2021, September). The impact of occupancy patterns on artificial light energy demand-simulation and post-occupancy-evaluation. In *Building Simulation 2021* (Vol. 17, pp. 3536-3543). IBPSA.

[6] Hammes, S., Weninger, J., Geisler-Moroder, D., Pfluger, R. & Pohl, W. (2021). Reduzierung des Kunstlichteinsatzes durch Anpassung der Nachlaufzeit an individuelle Anwesenheitsmuster. *Bauphysik*, 43(1), 50-64.

[7] Nagy, Z., Yong, F. Y. & Schlueter, A. (2016). Occupant centered lighting control: A user study on balancing comfort, acceptance, and energy consumption. *Energy and buildings*, 126, 310-322.

[8] Meerbeek, B., van Druenen, T., Aarts, M., van Loenen, E. & Aarts, E. (2014). Impact of blinds usage on energy consumption: automatic versus manual control. In *Ambient Intelligence: European Conference Aml 2014* (Vol 5., pp. 158-173). Springer International Publishing.

[9] Chraibi, S., Lashina, T., Shrubsole, P., Aries, M., Van Loenen, E. & Rosemann, A. (2016). Satisfying light conditions: A field study on perception of consensus light in Dutch open office environments. *Building and Environment*, 105, 116-127.

[10] Hammes, S., Geisler-Moroder, D., Weninger, J., Zech, P. & Pfluger, R. (2024). Market demands vs. scientific realities: A comparative analysis in the context of BIM-based and user-centred lighting control. *Developments in the Built Environment*, 19, 100526.

[11] Hammes, S., Weninger, J., Canazei, M., Pfluger, R. & Pohl, W. (2020). Die Bedeutung von Nutzerzentrierung in automatisierten Beleuchtungssystemen. *Bauphysik*, 42(5), 209-217.

[12] Hammes, S., Weninger, J., Pohl, W. & Pfluger, R. (2021, March). Die Bedeutung nutzerzentrierter Beleuchtung. In *Proceedings of LICHT2021* (pp. 436-450). LTG.

[13] Aghemo, C., Blaso, L. & Pellegrino, A. (2014). Building automation and control systems: A case study to evaluate the energy and environmental performances of a lighting control system in offices. *Automation in Construction*, 43, 10-22.

[14] Williams, A., Atkinson, B., Garbesi, K., Page, E. & Rubinstein, F. (2012). Lighting controls in commercial buildings. *Leukos*, 8(3), 161-180.

[15] Despenic, M., Chraibi, S., Lashina, T. & Rosemann, A. (2017). Lighting preference profiles of users in an open office environment. *Building and Environment*, 116, 89-107.

[16] Labeodan, T., De Bakker, C., Rosemann, A. & Zeiler, W. (2016). On the application of wireless sensors and actuators network in existing buildings for occupancy detection and occupancy-driven lighting control. *Energy and Buildings*, 127, 75-83.

[17] Galasiu, A. D., Newsham, G. R., Suvagau, C. & Sander, D. M. (2007). Energy saving lighting control systems for open-plan offices: a field study. *Leukos*, 4(1), 7-29.

[18] Guo, X., Tiller, D. K., Henze, G. P. & Waters, C. E. (2010). The performance of occupancy-based lighting control systems: A review. *Lighting Research & Technology*, 42(4), 415-431.

[19] Garg, V. & Bansal, N. K. (2000). Smart occupancy sensors to reduce energy consumption. *Energy and Buildings*, 32(1), 81-87.

[20] Chraibi, S., Creemers, P., Rosenkötter, C., van Loenen, E. J., Aries, M. B. & Rosemann, A. L. (2019). Dimming strategies for open office lighting: User experience and acceptance. *Lighting Research & Technology*, 51(4), 513-529.

[21] Hammes, S., Weninger, J. & Zech, P. (2024, November). Closer to Realtime: A Comparison of Machine Learning methods to reduce artificial switch-off times. In *IEEE Sustainable Smart Lighting World Conference (LS2024)*. IEEE. Currently in publication.

[22] Hammes, S., Weninger, J., Pfluger, R. & Pohl, W. (2022). Take the right seat: the influence of occupancy schemes on performance indicators of lighting in open plan offices. *Energies*, 15(9), 3378.

[23] Hammes, S., Weninger, J., Gschwandtner, P. & Zech, P. (2024, June). Achieving a deeper understanding of user-related influences on artificial lighting energy demand using High-Performance Computing. In *Proceedings of the Building Simulation Applications BSA 2024*. IBPSA. Currently in publication.

[24] Weninger, J. & Hammes, S. (2024, September). Post-Occupancy derived User Profiles for improved Energetic and Light Dose related Building Simulation. In *Proceedings of the 30th Session of the CIE (CIE x50:2023)*, pp. 184-195). CIE.

[25] Ghayvat, H., Mukhopadhyay, S., Gui, X. & Suryadevara, N. (2015). WSN-and IOT-based smart homes and their extension to smart buildings. *Sensors*, 15(5), 10350-10379.

[26] Kazmi, A. H., O'grady, M. J., Delaney, D. T., Ruzzelli, A. G. & O'hare, G. M. (2014). A review of wireless-sensor-network-enabled building energy management systems. *ACM Transactions on Sensor Networks (TOSN)*, 10(4), 1-43.

[27] Doulos, L., Tsangrassoulis, A. & Topalis, F. V. (2014). Multi-criteria decision analysis to select the optimum position and proper field of view of a photosensor. *Energy conversion and management*, 86, 1069-1077.

Authors



Dipl.-Ing. Johannes Weninger studied architecture at the Leopold-Franzens-University of Innsbruck with focus on architectural theory and worked as an external lecturer and research associate at various universities in Austria and Germany in the field of Artificial Intelligence and Cyber-physical Systems. Until 2018 he was a research associate at the Karl-Franzens-University Graz in the Department of Biological Psychology. Since 2016 he has been working at Bartenbach research on the topics of non-visual light effects, digitization and machine learning. He has headed Bartenbach's research team since 2022.



After studying electrical engineering, **Dr. techn. Sascha Hammes, M.Sc.** worked as a specialist planner for electrical building equipment and in the research and development department of Bartenbach. As part of an industry-related dissertation on user-centered lighting and the potential of post-occupancy evaluations, he completed his doctorate at the University of Innsbruck, where he has also been employed as a post-doctoral researcher since 2022. He is particularly involved in research projects in the areas of building automation systems, especially user-centered systems, sensor technology, and data analysis.

Bartenbach GmbH, founded in 1976 by Christian Bartenbach, is a leading independent lighting design and consulting firm based in Wattens, near Innsbruck, Austria. The company specializes in holistic lighting solutions that enhance human well-being, improve task performance, enrich atmospheres, and promote social interaction. Their interdisciplinary team of approximately 80 experts from fields such as architecture, design, physics, psychology, and engineering collaborates on innovative artificial and daylight planning, as well as the development of optical components and lighting research.

<https://www.bartenbach.com>

The **University of Innsbruck**, established in 1669, is a prominent public research university located in Innsbruck, Austria. It is the largest educational institution in western Austria, with approximately 28,000 students and 5,500 staff and faculty members.

<https://www.uibk.ac.at/en/>

Will Street Lights Become the Location of Choice for Sensors?

Sara El Feky, Karl Göransson, Walter Longwe and Graham Mawer
at Barcelona's Zigurat Institute

e-zigurat.com

There are more than 300 million street lights in the world and they are found on almost every urbanized street in the developed and developing world. A group of graduate students at Barcelona's Zigurat Institute⁵ have been looking at whether this enormous infrastructure investment could be leveraged for more than just lighting. They have been considering whether the next wave in the evolution of street lights might involve the widespread addition of smart city sensors to the lights.



Multisensor deployment Salamanca, Spain.
Image credit: Signify.

Street lights are ubiquitous, structurally secure, electrically powered and elevated over the roadway. Increasingly, as they are converted to LEDs, the street lights are becoming digital devices and are being paired with smart street lighting controls. This combination of characteristics make street lights a potentially ideal location to host additional smart city sensors at low cost. The sensors they could host might measure traffic, climate, pollution or noise parameters.

A key premise for the Zigurat project was that the street light may ultimately be the least expensive location to widely deploy sensors in the public domain. If a sensor can be directly plugged into a street light, installation labor costs will be low. No mounting bracket would be required and no additional power supply infrastructure would be needed (e.g. wiring, conduit, fuse, metering, metering box, surge protection). In some cases, where utilities own the lighting, placing sensors on lights may avoid complex pole access negotiations and charges for pole access.

The Pivotal Role of the Zhaga-D4i Standard

The Zhaga Consortium⁶ is an industry association of some 600 members that publishes industry standards for interfaces of LEDs and other components within lights. One of its industry standards, Zhaga Book 18⁷, addresses the interconnection of components in outdoor lighting.

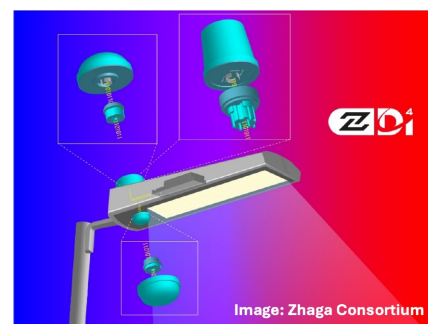

Zhaga D4i luminaire.

The Book 18 standard has progressively evolved to allow a two-node architecture where, for example, a smart control device can sit on the top of the street light and an additional sensor can be placed on the bottom of the light (see image). The sensor might be a motion sensor to help control lighting levels but it could also be a smart city sensor. Recognizing the potential for street lighting to play a wider role as a piece of smart city infrastructure, the Zhaga Consortium staged an awards program in 2023 for Smart City Sensors.⁸

The Zigurat project, while not affiliated with the Zhaga Consortium, recognised the pivotal role that Zhaga Book 18 and the D4i certification process is playing in shaping the future of public lighting.

Database of Zhaga-based Device Suppliers Released

While the market for Zhaga-based products is still relatively young, the Zigurat project has identified 42 suppliers, globally, offering Zhaga-based smart street lighting controls, motion sensors and smart city sensors. A table of these suppliers is included in this article.

⁶<https://zhagastandard.org>

⁷<https://zhagastandard.org/books/overview/smart-interface-between-outdoor-luminaires-and-sensing-communication-modules-18.html>

⁸<https://www.zhagastandard.org/zhaga-smartcitysensor-awards.html/>

Survey of Controls and Sensor Suppliers

The Zigurat project team used the database of suppliers to undertake a survey in mid-2024. About half of the identified suppliers participated in the survey with 21 responses received.

One of the key survey questions focused on the international Zhaga-D4i product certification regime⁹ launched in 2021 in conjunction with the DALI Alliance. At the time of the survey, only 10 of the 42 suppliers identified in the project had chosen to certify one or more of their products. Of the survey respondents, 20% were not intending to seek certification or were unsure that they would while a further 43% said they were planning to or in the process of seeking certification. However, the rate of new certifications by suppliers who have not previously certified a device appears low in the public registry.¹⁰

Based on the survey results and direct feedback from suppliers, the project team concluded that there was compelling evidence of hesitancy to certify new products by many suppliers despite the demonstrated marketing benefits of having certified products. The survey didn't include end users and whether they valued the interoperability conformation that Zhaga-D4i certification offers.

The project team also looked at the communications approach being taken by the suppliers of smart city sensors. Zhaga Book 18 does not restrict how sensors communicate. Sensor data can be channelled via the DALI Bus in the luminaire and then transmit via the smart street lighting controls device to the Central Management System (CMS) for the lighting controls provider. However, by not restricting how sensors communicate, the Zhaga standard also allows sensors to communicate independently. 63% of survey respondents who sold smart city sensors said that they were either communicating independently via communication chips in their sensors (e.g., via NB-IoT or LoRaWAN) or preferred to communicate independently given that Zhaga Book 18 does not restrict the choice of communications approach. Based on the survey results and direct discussions with suppliers of smart city sensors, the project team concluded that trying to channel general purpose sensor data via the DALI Bus and out to a street lighting CMS was proving challenging for some suppliers. The path of least resistance for many suppliers was to include a communication chip in their sensor and send the data

directly to their own CMS or to a general smart city platform.

In terms of device costs, the survey results indicated that 75% of smart street lighting controls providers and 63% of motion sensor suppliers were selling their devices for less than 100 Euros. Costs for smart city sensors were much more varied, ranging from below 100 Euros to 600 Euros. The project team concluded that the early stage of the market for these smart city sensors, the lower volumes and the complexity of some sensors were the likely root causes of the wide range of pricing.

The final survey question focused on the motivation for suppliers to develop Zhaga-based devices. An overwhelming 86% of survey respondents cited the street light as being a good location for many sensing tasks while 71% said that their customers were asking for the devices. In terms of cost, 48% of suppliers believed that the street light-based sensors were less expensive for their customers to purchase and deploy while 43% said that they were less expensive to produce than other sensors. From the responses, the project team concluded that there appeared to be a widespread industry view that the street lights are indeed a good location for many sensing tasks and that customers want the devices.

Conclusions

An ever-wider array of Zhaga-based smart city sensors is continuing to emerge but some barriers remain to widespread adoption. Based on the relatively slow rate of certifications and the evident preference of suppliers for using independent communication technologies, the Zigurat project team concluded that there would be advantages in more overtly promoting that Zhaga Book 18 does not restrict how sensors communicate and that sensors which communicate independently can still meet all certification requirements. Overall, cities could benefit from both greater Zhaga-based sensor choice, from sensors which are compatible with their existing IoT networks and from the increased confidence and lower risks which comes with more sensors being independently certified.

The project team also recommended that there be further studies monitoring Zhaga-D4i adoption, development of more case studies about early adoption, economic analysis quantifying the benefits of widespread use of street lights for hosting of smart city sensors and made a series of recommendations about greater stakeholder engagement. ■

Suppliers of Zhaga-Based Smart Street Lighting Controls, Motion Sensors and Smart City Sensors

- Algorab, Italy
- Bega, Germany
- Carandini, Spain
- Changzhou Highland Smart Things Technology, China
- Citygrid, Denmark
- Citylight, Latvia
- Climate Change Response, Australia
- Comlight, Norway
- edgemachines, Australia
- eSave, Switzerland
- Flashnet, Romania
- Fonda Tech, China
- Hynall, China
- iciti, Germany
- IR-TEC, Taiwan
- Lacroix, France
- Legrand, France
- Lixtec, Austria
- Lucy Zodion, United Kingdom
- Lumenradio, Sweden
- Lumos Controls, United States
- Mauglo, Latvia
- NAS, Norway
- Novaccess, Switzerland
- Olfer, Spain
- Paradox Engineering, Switzerland
- Remoticom, The Netherlands
- Saphi, Australia
- Schreder, Belgium
- Shanghai Long-Join Intelligent Technology, China
- Shuncom AIOT, China
- Signify (Philips), The Netherlands
- SITECO, Germany
- Sundrax, United Kingdom
- TE Connectivity, United States
- Tridonic, Austria
- Twilight, The Netherlands
- Vibe Lighting, Australia
- Westire, Ireland
- Xiamen lotcomm Technology, China
- X-LOGIC, Croatia
- Zumtobel Group, Austria

Produced by Sara El Feky, Karl Göransson, Walter Longwe & Graham Mawer for the Zigurat Institute Master's in Global Smart City Management. All content provided by the suppliers with permission to publish or collected from publicly available information. All requests for changes to this publicly available database should be sent to: <mailto:gmawer@nextenergy.com.au>.



⁹<https://www.dali-alliance.org/zhaga-d4i/>

¹⁰<https://www.zhagastandard.org/products.html>

LED Matrix Manager Empowers High Density Automotive Intelligent and Safe Front Light System

Jason Bai, Application Engineer at Analog Devices

The LED matrix manager provides original equipment manufacturers (OEMs) with an advanced front light system that enhances safety and distinguishes their brand. It offers seamless integration, high performance coupled with safety features, and effectively reduces electromagnetic interference (EMI). Additionally, it incorporates a built-in logarithmic fade-in/fade-out function, low RDS(ON), and slew rate control for optimal operation. This article will discuss how the LED matrix manager can be used to elevate the intelligence of automotive front light system designs.

About the Author: Jason Bai is an application engineer at Analog Devices and is responsible for support and application of automotive power products. Jason joined Maxim Integrated (now part of Analog Devices) in 2020 and holds a master's degree in electrical engineering from Miami University (Ohio).



For more information visit
www.analog.com

Introduction

The increasing adoption of intelligent front light systems is primarily driven by safety and the desire for unique brand identities. These systems are growing at a rate of 8.3% annually [1]. They feature glare-free high beams, LED, and matrix lighting, which together form adaptive driving beam (ADB) systems. These ADB systems eliminate the risk of blinding oncoming traffic. To further enhance safety and comfort for drivers, automotive OEMs are incorporating additional adaptive lighting functions (AFS) like cornering light and dynamic curve light.

The LED matrix manager plays a crucial role by efficiently managing current for matrix and pixel lighting. It typically controls LED voltage (up to 65 V) using 6 to 12 integrated switches, simplifying design and saving time. Its integrated MOSFET, rated between 5 V and 14 V, has a low on-resistance RDS(ON), allowing it to handle LED currents up to 2 A.

Additionally, the LED matrix manager offers an optimal pulse-width modulation (PWM) dimming setup with exceptional performance. This includes smooth transitions between PWM dimming states and the option for internal or external clock control for PWM dimming.

The rapid advancements in the dimming performance of the LED matrix manager are contributing significantly to increased safety, improved driving experiences, and enhanced brand identities.

Advantages of LED Headlights

Currently, automobiles use halogen, xenon, or LED lamps for their front lights. Xenon lamps were common in higher end vehicles for a while, but now LED lamps are becoming more popular. It's likely that LED lamps will soon be the most common choice.

The differences among these lamps are summarized in **Table 1**. LED lamps are brighter than halogen, but not as bright as xenon. Xenon lamps can be too dazzling at night. Typically, halogen lamps use only 20% of their power for light, while LED lamps use 80% [2]. Even though LED lamps cost more initially, their long lifespan and energy efficiency can save money in the long run. They are also smaller, giving carmakers more design freedom for headlights.

	Halogen Lamp	Xenon Lamp	LED Lamp
Brightness	Low	High	Medium
Energy Efficiency	Low	Medium	High
Lifespan	Short	Medium	Very long
Size	Large	Large	Small
Price	Low	Medium	High

Table 1: Comparison between halogen lamp, Xenon lamp, and LED lamp.

LED Exterior Front Light System Overview

A front light system as shown in **Figure 1** includes a microcontroller, voltage sources, current sources, and LED lamps. The microcontroller, referred to as the LED module (LM), is situated outside of the lamps. It's commonly known as the LED control module (LCM). The LCM often employs the CAN bus to communicate and monitor the status of the LM, including features like animation and brightness. Inside

the LCM, buck-boost topologies are frequently used as LED drivers, allowing them to accommodate different LM configurations, such as 6 or 12 LEDs in a single LM. In **Figure 1**, the LED driver within the LCM comprises both voltage and current sources. Typically, the voltage sources adjust the battery voltage to a higher level, determined by the number of LEDs, while the current sources deliver a consistent current to the LM and lower the boosted voltage.

The automotive exterior front lighting system has several lighting functions, including a low beam headlamp (LB), high beam headlamp (HB), daytime running light (DRL), front position lamp (PL), and turn indicator. Depending on the specific lighting functions, the LM is set up with varying numbers and colors of LEDs. This means the LCM must provide the appropriate current source to regulate brightness. To save costs, manufacturers might integrate two or more lighting functions into a single LM, like combining daytime running light and front position light.

The LED matrix managers, such as the MAX25608, are used to control LEDs individually with different dimming scenarios, such as welcome functions and a wiping indicator. The LED matrix managers consists of multiple switches that can be independently programmed to bypass the LEDs across each of the switches in the string. Each switch can be turned fully on, fully off, or dimmed with or without fade-transition mode. The dim frequency is set by an internal oscillator or set to an external clock source.

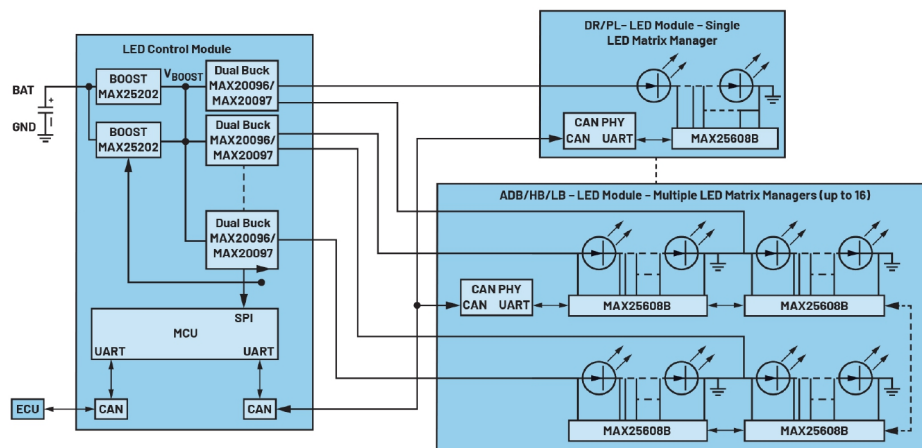

Figure 1: An LED front light system.

Smart Lighting Function: ADB

The ADB systems are a smart HB control system that can adaptively adjust the beam pattern based on driving conditions. The full high beam can be distracting to oncoming drivers and pedestrians. The adaptive capabilities of an ADB system can automatically turn the bright lights off or partially beam to avoid dazzling drivers and pedestrians. Based on different headlight resolution requirements, the LM of an ADB system would consist of four or more LED matrix managers to control four or more LED zones. With an LED matrix manager, ADB systems can be easily implemented and LEDs in an ADB system can be dimmed individually.

Fault Detection and Protection of LED Matrix Manager

Detecting if LEDs are open or shorted is vital for safety. A system with safety features reduces the impact of potential failures. Checking for open or shorted LEDs in the headlight system helps catch any issues that might occur. The LED matrix manager naturally provides protection against short circuits and open circuits. The MAX25608 keeps track of any faults related to open or short circuits. The open-LED fault is triggered when the voltage between the individual LED switch drain node (Figure 2) and the switch source node exceeds the open threshold and is reported in the status register. As shown in **Figure 3**, the voltage cross switch is 4.88 V, which triggers an LED open fault, when open threshold is set to 4.66 V. A short LED fault is triggered when the voltage between the

switch drain node and the switch source node is below the short threshold for an open switch condition and is reported in the status register. **Figure 4** provides an example, whereby the voltage cross fault is 2.4 V, which triggers an LED short fault when the short threshold is set to 1.4 V.

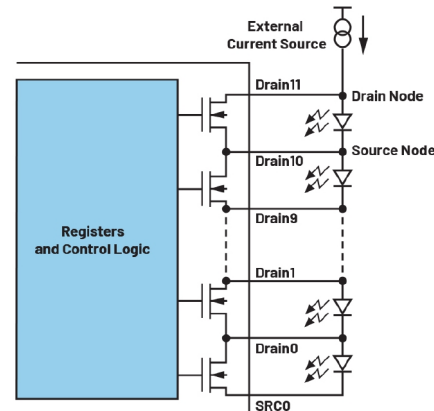

Figure 2: LED fault detection.

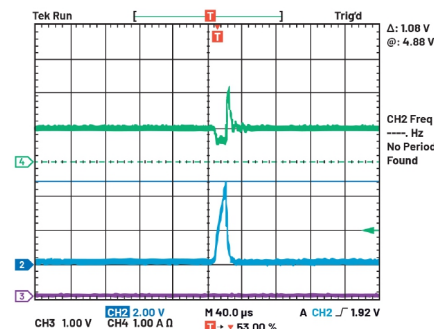

Figure 3: The MAX25608 LED open detection (Channel 2: Drain voltage; Channel 3: FLTb; Channel 4: LED current).

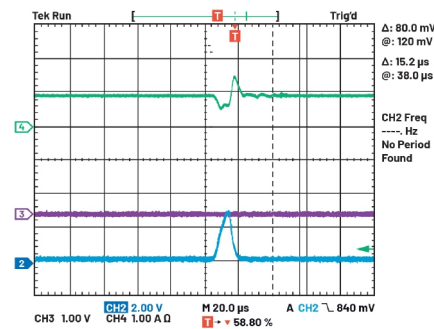

Figure 4: The MAX25608 LED short detection (Channel 2: Drain voltage; Channel 3: FLTb; Channel 4: LED current).

Safe UART Communication Protocol

ADI's MAX25608 provides multidrop universal asynchronous receiver-transmitter (UART) communications between the microcontroller and up to 16 MAX25608 devices. The write and read command examples are shown in **Figure 5** and **Figure 6**. To ensure data security, the read/write transactions are protected using a 3-bit

cyclic redundancy check (CRC) on the packet. If the microcontroller transmits a data packet with an incorrect CRC, the MAX25608 does not reply and discards the attempted communication.

In the event of lost communication, the UART watchdog feature of the MAX25608 sets the switches into a preconfigured state. When a microcontroller communication line is inactive for more than the set time, the fault indicator is on, and the LEDs enter a preconfigured state if the UART watchdog is enabled. As shown in **Figure 7**, the UART watchdog timer is set to 500 ms. After a UART receiver signal is inactive for 480 ms, the LEDs are turned off since the preconfigured state is off.



Figure 5: An example of a write command.

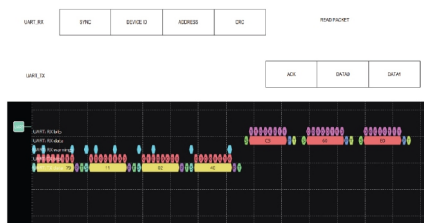

Figure 6: An example of a read command.

Performance metrics such as thermal and EMI performance can easily be evaluated. As shown in **Figure 8**, the matrix manager is driven by the MAX25601 boost buck LED driver with all switches closed on the matrix manager and provide a 1.5 A output to 12 LEDs. Under a room temperature environment, only a 30.4°C temperature rise is captured.

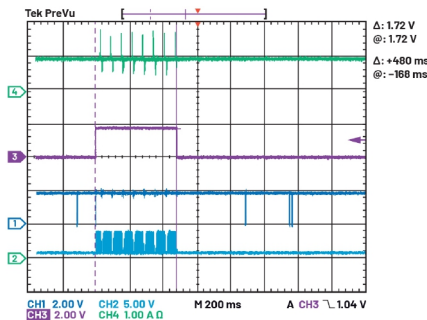

Figure 7: The MAX25608 UART watchdog function (Channel 1: UART receiver; Channel 2: Drain voltage; Channel 3: FLTB; Channel 4: LED current).

Performance of the LED Matrix Manager

ADI's MAX25608 offers advanced integration, high performance and safety, flexibility, and EMI mitigation functionality such as the following:

- Integration: Provides built-in logarithmic fade-in/fade-out capability that simplifies LED programmability and reduces taxation on system bus lines.
- High performance and safety: Features advanced fault protection and management for open, short, and open-trace LED detection. Low RDS(ON) safely enables high LED current.
- Flexibility: Supports multiple ICs to manage large LED pixel counts; allows designers to configure LED groups, such as 1 string × 12 series switches, and 2 strings × 6 series switches.
- EMI mitigation: Slew-rate control reduces EMI and noise.

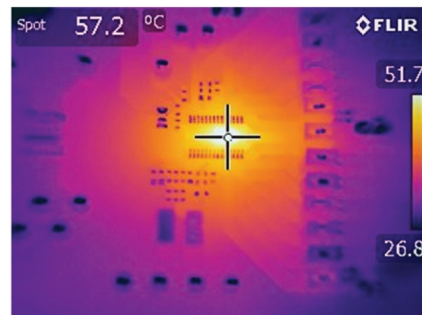

Figure 8: The MAX25608 thermal camera capture under 1.5 A condition.

Under the same test environment of a 1 A output to 12 LEDs, EMI results show no spikes due to the MAX25608's proprietary charge pump design as shown in **Figure 9**.

The MAX25608 is driven by the MAX25600 H-bridge LED driver with two LEDs at each channel. A 4.7 μF output cap and a filter (1 μH + 0.1 μF) are added to the MAX25600. The current spike is measured while dimming, as shown in **Figure 10**.

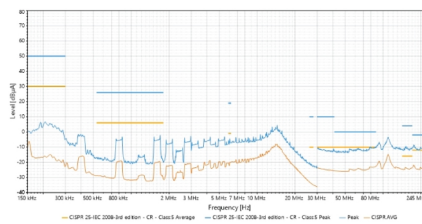

Figure 9: A conducted EMI of the MAX25608.

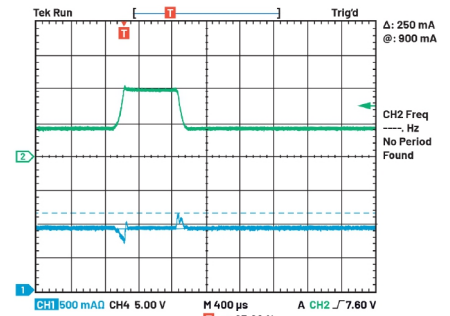

Figure 10: Current spikes during dimming.

Conclusion

As the trend of vehicle electrification and intelligence is growing fast, the lighting system has become an increasingly important feature in present and future vehicle designs. The lighting system is characterized by flexibility, efficiency, reliability, and more personalized and artistic effects. ADB and AFS are considered advanced safety features. In these designs, an accurate, efficient, and reliable LED manager for the LED matrix is required. ■

References

- [1] Sejal Akre. "Automotive Intelligent Lighting System Market Research Report Information by Technology (Xenon, LED, Halogen), Type of Light (Intelligent Ambient Lighting, Adaptive Headlight), Vehicle Type (Passenger, Commercial) And Region (Asia-Pacific, North America, Europe, And Rest Of The World)-Market Forecast Till 2032." Market Research Future, March 2024. <https://www.marketresearchfuture.com/reports/automotive-intelligent-lighting-system-market-7615#:~:text=Automotive>
- [2] "LED vs Halogen Bulbs." DISPLAYS2GO, August 2023.

SPECIAL

BEST LIGHT

We break new ground. Daylight and artificial light, reality light, research and development - we create spaces that not only illuminate, but also inspire. Sustainable, customised and visionary solutions.

www.bartenbach.com

M. info@bartenbach.com

T. +43 5224 22381

Expert Talks on Light – LUMILEDS

Exploring Innovation in Lighting: Advanced Solutions for High-Density Multi-Color LED Arrays and Revolutionary Automotive Body Illumination.

Talk#1: Challenges and Solutions when Designing Large Cluster Multi-color LED Sources



<https://youtu.be/mqfKDY1gDOQ>

Rob Engelen's presentation delves into the challenges and solutions for designing high-density, multi-color LED arrays for applications such as architectural, stage, and studio lighting. The presentation emphasizes achieving optimal light output, color mixing, thermal management, and compact LED packaging to meet modern lighting demands. A central focus is resolving conflicting design requirements, such as the preference for large LED dies to maximize light performance versus the need for small packages to ensure close-packing of LEDs.

To address these challenges, the presentation discusses advanced technologies. For thermal management, heat dissipation solutions include the use of innovative PCB substrates such as ceramic, insulated metal substrates (IMS) with copper pedestals, and advanced heat sink designs. These designs enable high drive currents, efficient heat transfer, and reduced noise by eliminating fans. Electrical routing is optimized using a three-stripe footprint to enable compact, efficient layouts while enhancing color mixing through better randomization of individual colors.

For more information visit:
<https://www.lumileds.com/>

Talk#2: Expanding the Horizons of Car Body Lighting



<https://youtu.be/KM1da8LihY>

Dr. Thorsten Anger's presentation, "Expanding the Horizons of Car Body Lighting," highlights innovations in automotive lighting design, emphasizing cutting-edge technologies that balance styling, functionality, and market feasibility. It explores diverse applications, including singular lit elements, backlit surfaces, and three-dimensional illuminated structures, tailored to unique vehicle designs.

The presentation identifies challenges in adapting advanced lighting technologies, typically reserved for high-end vehicles, to mainstream platforms. Lumileds addresses this with scalable, modular solutions that prioritize efficiency, cost-effectiveness, and sustainability. Key innovations include the LUXEON Versat 2016 LED Family for customizable brightness and spectral tuning, Dynamic Signature Lights with 192 individually addressable pixels for dynamic styling, and the LUXEON 3D LED Series, a flexible solution for slim, elongated designs. The Coin Concept Design introduces modular, efficient single-emitter solutions optimized for safety and easy integration.

Advanced technical features like collimator lenses, diffuse film covers, and optimized geometries enhance luminous efficiency and uniformity, catering to large, curved surfaces while ensuring high-performance optical quality. Lumileds' focus on sustainability is evident through recyclable materials and automated, modular integration systems designed for mass production.

Supported by



LpS DIGITAL

<https://youtube.com/c/LpSDIGITAL>

LpS DIGITAL CONFERENCE



Challenges and Solutions when Designing Large Cluster Multi-Color LED Sources

by Rob Engelen, Director of LED Applications Engineering at Lumileds

L241108 – LED Sources | Sponsored

Challenges and solutions when designing large cluster multi-color LED Sources

Rob Engelen
Director of LED Applications Engineering



LpS DIGITAL CONFERENCE





Expanding the Horizons of Car Body Lighting

Dr. Thorsten Anger, Product Manager 3D LED & MxN at LUMILEDS

L291124 – Automotive | Sponsored

Expanding the Horizons of Car Body Lighting

T. Anger
10_2024

Expert Talks on Light

High-quality Content about Lighting Technologies, Design and Applications



Subscribe to the LpS Digital YouTube Channel





DALI+ with Thread

DALI lighting control plus wireless
and IP-based networking



Find out more about DALI+
www.dali-alliance.org/dalipus

SHE REALIZES SHE CAN GET ALL THE KNOCKOUT BENEFITS OF CASAMBI WIRELESS...

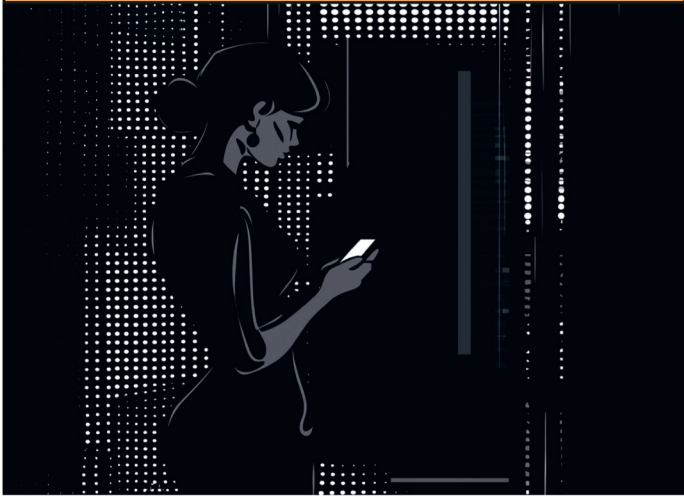

...WITH HER EXISTING DALI NETWORK.

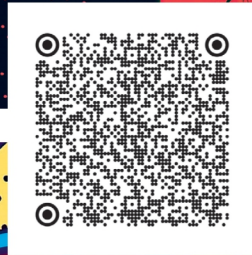

Just when you thought your network was old-fashioned it became new and up-to-date with Salvador series from Casambi

SALVADOR series from

CASAMBI



DEADLINES | LpR 108

AD CLOSE
March 1, 2025

MATERIAL DUE
March 1, 2025

DIGITAL PUBLICATION
March 15, 2025

PRINT PUBLICATION
March 30, 2025

ENQUIRIES

info@lugerresearch.com

Subscribe



<https://www.led-professional.com/misc/subscribe>

Advertise



<https://www.led-professional.com/advertise>

PREVIEW* Mar/Apr 2025 | LpR 108

Lighting Outlook

The March/April 2025 issue of LpR Magazine offers a diverse lineup of content focused on the latest developments in the lighting industry. Highlights include a Pre-Show Report on Lightfair International 2025, previewing trends and innovations expected at the Las Vegas event. The issue features an exclusive interview with Prof. Dr. Hao Luoxi, a global expert in illumination and urban planning, discussing advancements in lighting education and design. A company spotlight on SunLED showcases its leadership in LED component manufacturing, emphasizing innovation and reliability. The Innoscience GaN LED Driver article explores the transformative benefits of Gallium Nitride technology in LED applications, such as improved efficiency and compact designs. Additional content includes a white paper from mwConnect on connectivity solutions and an article on Polab's groundbreaking streetlighting technology with innovative LED headlamps. Altogether, this issue provides cutting-edge insights into lighting technology and applications for professionals worldwide.

* Subject to change without notice.

Annual Subscriptions

LpR Digital Magazine

- eMagazine (PDF download)
- 6 Issues per Year (Bi-monthly)
- Full Archive Access (all previous eMagazine issues)
- Business Issue to share and use within organizations
- EUR 78.80

LpR Printed & Digital Magazine

- Print Magazine including shipping
- eMagazine (PDF download)
- 6 Issues per Year (Bi-monthly)
- Full Archive Access (all previous eMagazine issues)
- Shipping costs included
- EUR 97.80

Cover Page: The Notre-Dame Cathedral in Paris – a UNESCO World Heritage Site since 1991 – was recently reopened, five years after the devastating fire. Regarding the professional lighting solution, the Zumtobel Group supported artist and lighting designer Patrick Rimoux, who was commissioned for the overall lighting design, with state-of-the-art lighting technology and decades of expertise in illuminating the vaults of the nave. The successful "Renaissance" of Notre-Dame was made possible not only by the Austrian Zumtobel Group – represented by its Paris-based Zumtobel brand and Thorn Lighting – but also through contributions from several other lighting experts.

Image: © Julio Piatti / Cathédrale Notre-Dame de Paris.

Imprint

LED professional Review (LpR)
ISSN 1993-890X

Publishing Company

Luger Research e.U. | © 2001–2025
Institute for Innovation & Technology
Moosmahdstrasse 30, A-6850 Dornbirn, Austria, Europe
info@lugerresearch.com | www.lugerresearch.com
P +43 5572 394489 | F +43 5572 394489 90

Publisher
Siegfried Luger +43 699 1133 5570
s.luger@lugerresearch.com

Editors
Dr. Günther Sejkora +43 5572 394489 70
editors@led-professional.com

Theresa König +43 5572 394489 70
editors@led-professional.com

Elio A. Farina +43 5572 394489 70
editors@led-professional.com

Art & Design
Sarah Rauchlechner +43 680 2305 445
hallo@moments-of-aha.com

Account Manager
Christine Luger +43 699 1133 5520
c.luger@lugerresearch.com

China, Hong-Kong
Lolo Young +852 9792 2081
lolo@castintl.com

Germany, International
Armin Wezel +49 30526 891 92
armin@eurokom-media.de

India
Priyanka Rai +91 124 4787331
priyanka.rai@binarysemantics.com

South Korea
Jung-Won Suh +82 2 78 58222
sinsegi@sinsegimedia.info

Taiwan
Leon Chen +886 2 256 81 786-10
Jeon@jkmmedia.com.tw

Benelux, France, Ireland, Scandinavia, UK
Zena Coupé +44 1923 85 25 37
zena@expomedia.biz

USA & Canada
Lesley Harmoning +1 218 686 6438
lesley@lhmandco.com

Jill Thibert +1 218 280 2821
jill@lhmandco.com

Copyrights – Luger Research e.U.

The editors make every reasonable effort to verify the information published, but Luger Research e.U. assumes no responsibility for the validity of any manufacturers, non profit organizations or individuals claims or statements. Luger Research e.U. does not assume and hereby disclaims any liability to any person for any loss or damage caused by errors or omissions in the material contained herein, regardless of whether such errors result from negligence, accident or any other cause whatsoever. You may not copy, reproduce, republish, download, post, broadcast, transmit, make available to the public, or otherwise use LED professional Review (LpR) content without prior written consent from Luger Research e.U.

© 2001–2025 Luger Research e.U. – Institute for Innovation & Technology – VAT No. ATU50928705, EORI No. ATEOS1000046213, Commercial Register FN316464p, Regional Court Feldkirch, Austria, Europe ■



The Comprehensive Guide to the Lighting World

The Global Lighting
Directory 2025

Published by
LED professional &
Trends in Lighting

Showcase in LpR #108

March/April 2025



Submit Your Proposal to our Editors

editors@led-professional.com

www.led-professional.com